

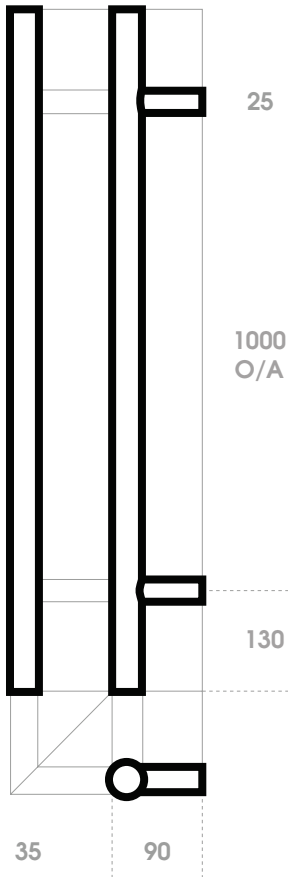

chateau

vertical towel rail



SPECIFICATIONS:

RECOMMENDED USE	RESIDENTIAL & COMMERCIAL
MATERIALS	304 S/S & H59 BRASS
TECHNOLOGY	DRY ELEMENT (NO LEAKS)
ELEMENT	REPLACEABLE
POWER ENTRY	BOTTOM ONLY
VOLTAGE	12V AC TRANSFORMER
WATTAGE	9.5W
STANDARDS	AS/NZS:60335.2.43



PLEASE READ:

This appliance is not to be used by persons (including children) with reduced physical, sensory or mental capabilities, or lack of experience and knowledge, unless they have been given supervision or instruction concerning use of the appliance by a person responsible for their safety.

Children should be supervised to ensure that they do not play with the appliance.

Must be installed so that switches and other controls cannot be touched by a person in the bath or shower.

Must be installed according to the wiring rules AS/NZS 3000:2018 and means for disconnection incorporated according to the wiring rules.

Must be installed in accordance with manufacturers instructions.

WARNING:

In order to avoid a hazard for very young children, this appliance should be installed so that the bottom of the rail is at least 600 mm above the floor.

Disclaimer: Products in this specification manual must be installed by licensed and registered tradespeople. The manufacturer/distributor reserves the right to vary specifications or delete models from their range without prior notification. Dimensions and set-outs listed are correct at time of publication however the manufacturer/distributor takes no responsibility for printing errors.

WARRANTY:

RESIDENTIAL – 5 YEAR DURABILITY WARRANTY
COMMERCIAL – 1 YEAR DURABILITY WARRANTY



chateau

vertical towel rail

ELECTRICAL:

Must be installed by a registered electrician

The 12V transformer must be located in a dry, accessible location (do not cover with insulation). Distance from transformer to towel rail should be no more than 2 metres. Typical transformer locations include: ceiling cavity, wall cavity (behind switch plate), cupboard, etc. See Fig. 1

May be installed in wet area electrical zone 3 (150mm from vanity or 600mm from shower/bath*).

We recommended a gap between the poles of 150-300mm.

Note: minimum spacing to be no less than 90mm. To ensure sufficient heating, run a maximum of 5 rails on one transformer.

WALL PREPARATION:

This appliance can be fixed to any type of wall, timber stud, steel stud or masonry (solid or cavity). Note: we DO NOT recommend fixing in to plasterboard or cement sheet alone. This will not hold long term.

Stud walls (timber or steel) require timber nogs at the correct position for all legs. If the precise position cannot be determined early in the job, consider noggging with 18mm construction ply, covering a large area.

PRE-WIRING (IN PARALLEL):

We recommended a gap between the rails of 150-300mm. Note: minimum spacing to be no less than 90mm.

Low voltage wiring tails should protrude approx. 150mm from the finished wall lining to allow for trimming.

Drill a 5mm hole through nog for pre-wire @ 10mm below desired finish height of each bottom stub (130mm up from bottom of rail). See Fig. 2. This will give clearance for locator blocks to be screwed through above.

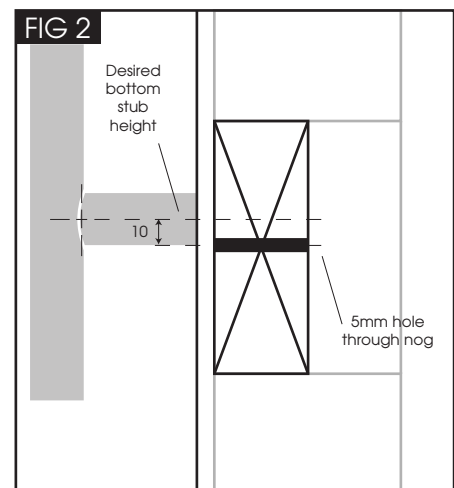
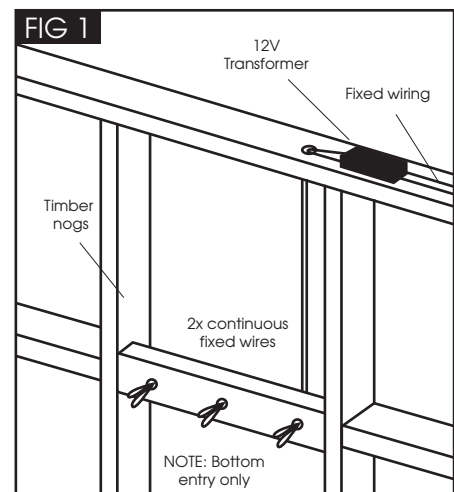



chateau

vertical towel rail

TOWEL RAIL FIXING & CONNECTION:

Once lined, pull the pre-wire through the top of the locator blocks. Depending on where the access point is located on your rail. See Fig 3A/B. Ensure they are pulled reasonably tight so you don't damage the wire while drilling.

Using the stainless steel screws supplied, screw the locator blocks to the nogs. See Fig 4. If drilling through tile, ensure you use a diamond drill bit.

Sit the rail on top of the blocks first, and use a spirit level to ensure the rail is plumb. The locator blocks are off-centre so can be rotated incrementally to ensure the rails will fit. Once level, remove the wirenut and make the connection with the towel rail. See Fig 5. Push the excess wiring and connectors into the towel rail.

Finally, press the rail firmly onto the locator blocks. Using the hex key provided, turn the locking hex screw inside the locator blocks **ANTICLOCKWISE**. See Fig 6.

SWITCH & TIMER:

The towel rail must have a switch in the bathroom that can be identified as the towel rail switch. This is typically a separate switch mechanism on the light switch plate for the bathroom. eg. lights, extractor, towel rail. Another option is a separate switch located nearby the rail. If required, a timer may be used in conjunction with the rail.

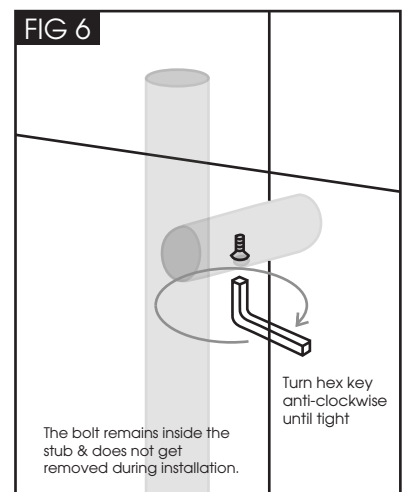
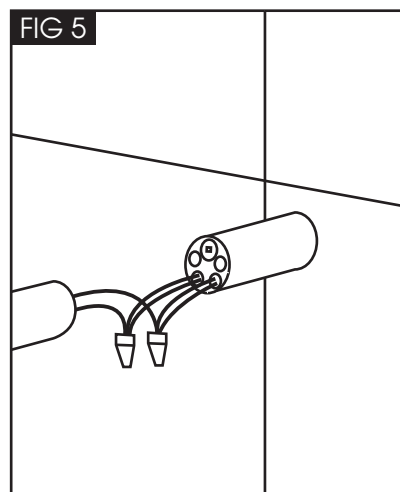
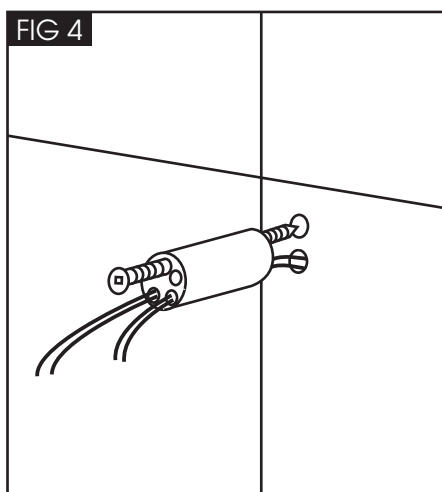
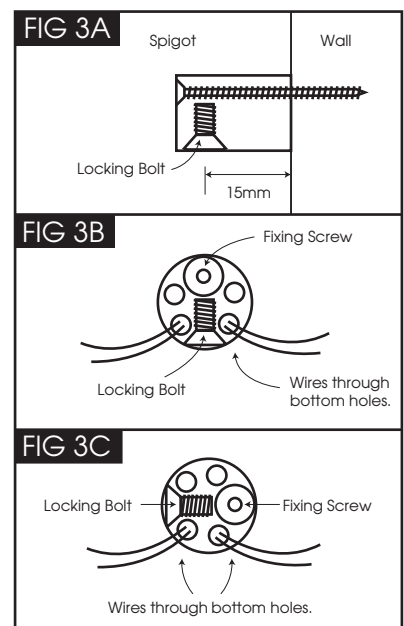

CLEANING:

Using a damp microfibre cloth and mild detergent, simply wipe rails. Do not use any rough gritty, highly acidic, alkaline or abrasive cleansers such as Jif, Ajax or cerium oxide as they may damage the surface of the rail. Note: The natural brass in this range is not coated or waxed. We recommend using a brass cleanser and microfibre cloth to restore the brass to your desired finish.



chateau

vertical towel rail

