

Installation Guide

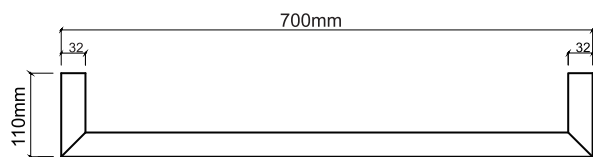

ITEM NO.	HTR-32R-3
WIDTH:	700MM
HEIGHT:	32MM (PER BAR)
DEPTH:	110MM
POWER:	13W * 3
WARRANTY:	5 YEARS
VOLTAGE:	12V

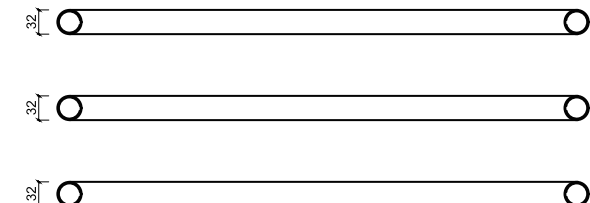

- Please note that this appliance **MUST** be installed as prescribed by the relevant wiring rules and regulations, including the regulations covering installation of appliances and accessories in 'wet areas' such as bathrooms, showers and laundries.

NOTE:

1. This class I appliance require an earth connection.
2. Please ensure this device is installed, connected and working. In order to avoid hazards for young children, this appliance should be installed so that the lowest rail is at least 600mm above the floor. This appliance **MUST** be installed by a licence electrician.
3. **DO NOT** install towel rails in areas which maybe subjected to saturation of water resulting in ingress of moisture.
4. If the product is abnormal and cannot be used normally, please immediately cut off the power supply and contact the after-sales staff for inspection and maintenance.

PRODUCT ACCESSORIES LIST

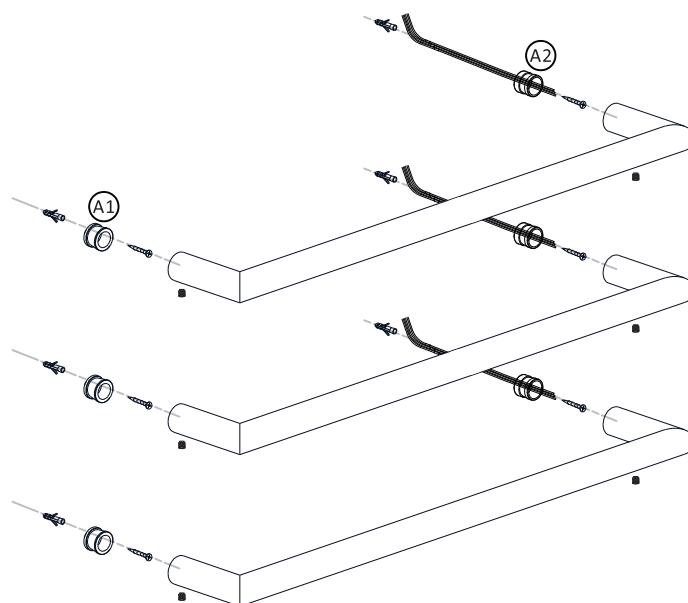
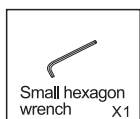
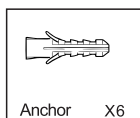
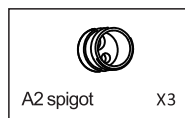
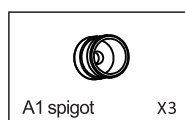
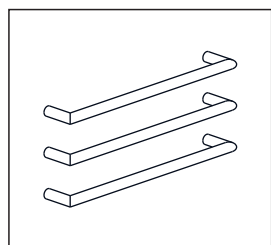

INSTALLATION STEPS

1. Put the towel rail against the wall in the desired position.
2. Using a pencil, draw around the end of each tube to mark their positions on the wall.
3. Remove towel rail from the wall.
4. Using a suitable drill bit, and then drill a hole into the tiles/wall to the required depth.
5. Place anchors in the holes.
6. Place spigot A2 and put the wire through the spigot A2.
7. Using the long screw to fix well. Then fix the rest spigot A1 accordingly.
8. Ensure that the wires are not energized and that they are connected in a safe manner.
9. Put the towel rail on once all spigots are in place, and then tighten using the Allen key provided.
10. Repeat steps 1 to 8 to complete the installation of the other bars.

SAFETY INFORMATION

As with any electrical appliance, you should be aware of basic safety precautions when using this heated towel rail. Please read these instructions, and file them for future reference:

1. Because this appliance gets hot, young children and infirm people should be closely supervised when nearby. Do not let young children treat the towel rail as a toy.
2. Be aware that the towel rail will get slightly hotter than normal during warmer weather and when insulated by towels.
3. The rail should NOT be used for anything other than its intended use.
4. It would be very dangerous to put the towels or anything else which has been in contact with hazardous liquids on this towel rail.
5. Use this appliance only on the voltage specified on the rating label.
6. Electrical work should only ever be done by authorised persons.
7. Do NOT immerse the towel rail in any liquid.
8. Make sure the supply cord never touches heated surfaces.
9. If the electrical cord or connection is damaged DO NOT attempt to repair; please contact the supplier.

WARNING

- A. To reduce the risk of injury, do not drape cord over the counter top or table top where it can be pulled down by children or tripped over unintentionally.
- B. A short power-supply cord (or detachable power-supply cord) is provided to reduce risks resulting from becoming entangled in or tripping over a longer cord.
- C. Longer detachable power-supply cords or extension cords are available and may be used if care is exercised in their using.
- D. If a long detachable power-supply cord or extension cord is used.
 1. The marked electrical rating of the detachable power-supply cord or extension cord should be at least as great as the electrical rating of the appliance;
 2. If the appliance is of the grounded type, the extension cord should be a grounding type 3-wire cord;
 3. The longer cord should be arranged so that it will not drape over the counter top or table top where it can be pulled on by children or tripped over.

A licensed electrician is required to carry out the installation of heated towel rail using the concealed wiring system.