

## Enjoy peace of mind. Register your appliance today.

Stay updated on better living services, safety notices and shop for accessories.

### 1. Open the camera app on your smartphone and point at the QR code to scan

Product Registration QR code is located on the front of your appliance or inside the door rim\*.

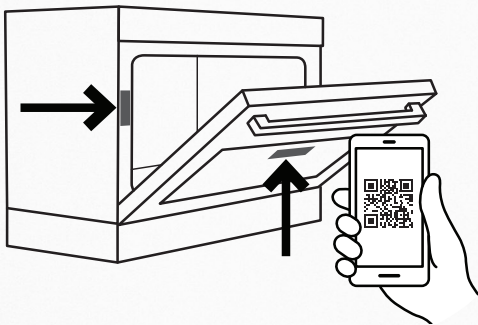

### 2. Tap the notification or link to open the registration form

### 3. Complete your details and enjoy peace of mind

\*Exact location of QR code may vary depending on oven model

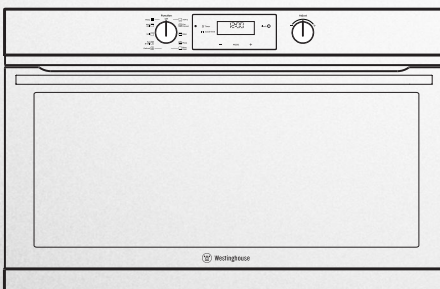

## 90cm ELECTRIC BUILT-IN OVENS

WVEP9716SD

## CONGRATULATIONS

Congratulations and thank you for choosing our product.

We are sure you will find your new cooker a pleasure to use and a great asset to your cooking. Before you use the appliance, we recommend you read through the whole user manual which provides a description of the product and its functions.

To avoid the risks that are always present when you use an appliance, it is important that the appliance is installed correctly and that you read the safety instructions carefully to avoid misuse and hazards. We recommend that you keep this instruction booklet for future reference and pass it on to any future owners.

This appliance complies with the requirements of Australian Standard AS/NZS 60335.2.6.

### Conditions of use

This appliance is intended to be used in household and similar applications such as:

- Staff kitchen areas in shops, offices and other working environments
- Farm houses
- By clients in hotels, motels and other residential type environments
- Bed and breakfast type environments

**Please ensure you read the instruction manual fully before you call for service, or a full service fee could be applicable.**

Record model and serial number here:

Model number:.....

Serial number:.....

PNC:.....

#### IMPORTANT INFORMATION THAT MAY IMPACT YOUR MANUFACTURER'S WARRANTY

Adherence to the directions for use in this manual is extremely important for health and safety. Failure to strictly adhere to the requirements in this manual may result in personal injury, property damage and affect your ability to make a claim under the Westinghouse manufacturer's warranty provided with your product. Products must be used, installed and operated in accordance with this manual. You may not be able to claim on the Westinghouse manufacturer's warranty in the event that your product fault is due to failure to adhere to this manual.

## CONTENTS

Important safety instructions .....	3
Description of your appliance.....	5
Installation of the appliance.....	6
Wiring requirements.....	9
Before operating your appliance for the first time.....	10
Installing your oven accessories .....	11
Using your oven .....	13
Easy Bake Steam.....	22
Cooking test .....	23
Cooking guide .....	23
Dealing with cooking problems .....	28
Cleaning your oven .....	29
Cleaning your pyrolytic oven .....	31
Troubleshooting.....	32
Warranty.....	35

Please read this user manual carefully and store in a handy place for later reference.

The symbols you will see in this booklet have the following meanings:



#### WARNING

This symbol indicates information concerning your personal safety.



#### CAUTION

This symbol indicates information on how to avoid damaging the appliance.



#### IMPORTANT

This symbol indicates tips and information about use of the appliance.



#### ENVIRONMENT

This symbol indicates tips and information about economical and ecological use of the appliance.

# IMPORTANT SAFETY INSTRUCTIONS

Please read this user manual carefully and store in a handy place for later reference. Pass the user manual on to possible new owners of the appliance.

Read the following carefully to avoid damage or injury.

**NOTE: you must read these warnings carefully before installing or using the appliance. If you need assistance, contact your Customer Care Department. The manufacturer will not accept liability, should these instructions or any other safety instructions incorporated in this book be ignored.**



## General warnings

- This appliance must not be used as a space heater.
- In order to avoid fire, the appliance must be kept clean and vents kept unobstructed.
- Do not spray aerosols in the vicinity of this appliance whilst it is in operation.
- Do not use or store flammable materials in this appliance storage drawer or near this appliance.
- Do not line the bottom of the oven with foil or cookware.
- Always use gloves when handling hot items inside the oven.
- Always turn the grill off immediately after use as fat left behind may catch fire.
- Do not modify this appliance.
- To maintain safe operation, it is recommended that the product be inspected every 5 years by an authorised service person.
- The cooking process must be supervised. A short term cooking process must be supervised continuously.
- **Always clean the grill/oven dish after every use. Excessive fat build up may cause a fire.**

## Installation, cleaning and servicing warnings

- An authorised person must install this appliance. (Certificate of Compliance to be retained).
- Before using the appliance, ensure that all packing materials are removed from the appliance.
- In order to avoid any potential hazard, the enclosed installation instructions must be followed.
- Ensure that all specified vents, openings and airspaces are not blocked.
- Where the appliance is built into a cabinet, the cabinet material must be capable of withstanding 85°C.
- Only authorised personnel should carry out servicing. (Certificate of Compliance to be retained).
- Always ensure the appliance is switched off before cleaning or replacing parts.
- Do not use steam cleaners, as this may cause moisture build up.
- Always clean the appliance immediately after any food spillage.
- This appliance must be earthed.
- Due to the weight (built in 70kg) and size of cookers, 2 persons are required to manually manoeuvre them. Remove loose items such as oven racks and trays to minimise weight.
- Do not use the handle to lift the cooker, instead open the oven door and lift the roof of the oven cavity.
- Take care when lifting to avoid any sharp edges not intended for lifting.
- This cooker must not be installed with a cut-off timer.
- Disconnection in the fixed wiring must occur in accordance with AS/NZS 3000 wiring rules.
- This appliance must be fixed in position or must be connected to the supply by a supply cord fitted with a male connector.

## IMPORTANT SAFETY INSTRUCTIONS (continued)



### WARNING

#### Oven

- During use the appliance becomes hot. Care should be taken to avoid touching the hot surfaces inside the oven.
- Switch the appliance off at the isolating switch before removing the oven light glass for globe replacement.
- To avoid an accident, ensure that oven shelves and fittings are always inserted into the appliance in accordance with the instructions.
- Do not use the door as a shelf.
- Do not push down on the open oven door.
- Do not cover the grill insert with foil, as fat left there may catch fire.
- Always keep the grill dish and baking tray clean as any residual fat may catch fire.



### WARNING

#### Child safety

- This appliance is not intended for use by persons (including children) with reduced physical, sensory or mental capabilities, or lack of experience and knowledge, unless they have been given supervision or instruction concerning use of the appliance by a person responsible for their safety.
- Children should be supervised to ensure that they do not play with the appliance.
- During use this appliance becomes hot. Care should be taken to avoid touching hot surfaces, e.g. oven door, heating elements etc.
- Accessible parts will also become hot when in use. To avoid burns and scalds children should be kept away.

# DESCRIPTION OF YOUR APPLIANCE

## WVEP9716SD

Pyro clean knob control electric oven

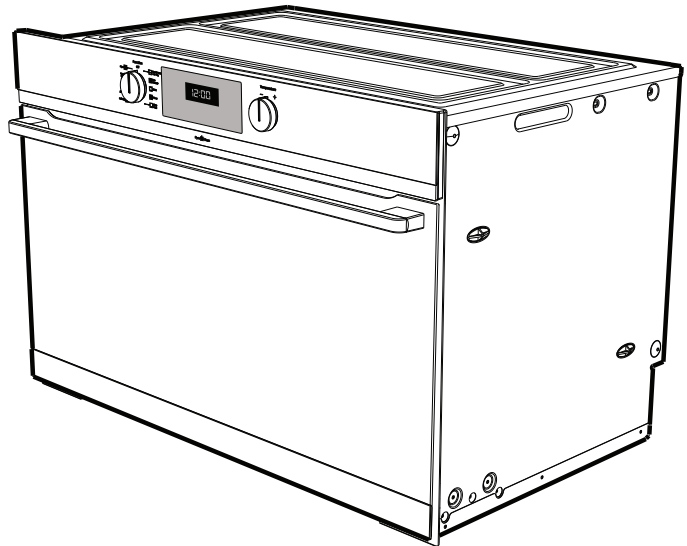

### Control Panel

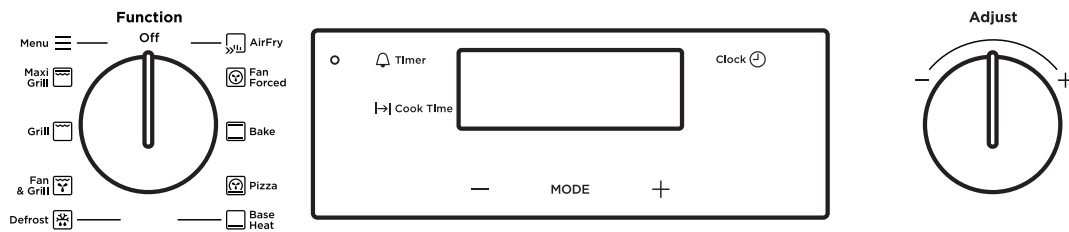

# INSTALLATION OF THE APPLIANCE

## Cabinet requirement

Models are designed to be built into cabinetry either below a benchtop or into a vertical cabinet.

### **WARNING**

- The cooker must be installed and serviced only by an authorised person.
- A Certificate of Compliance **MUST** be supplied to be kept by the customer.
- The packing materials must be removed before you install the cooker.
- The surrounding kitchen cabinets must be able to withstand 85°C. Electrolux **WILL NOT** accept responsibility for damage caused by installation into kitchen cabinets which cannot withstand 85°C.
- The vents, openings and air spaces **MUST NOT** be blocked.
- You **MUST NOT** lift or pull the cooker by the door handle.
- The cooker **MUST** be checked every five years.
- If the supply cord is damaged, it must be replaced by the manufacturer, its service agent or similarly qualified persons in order to avoid a hazard.
- The appliance must not be installed behind a decorative door in order to avoid overheating.
- Due to the weight (70kg) and size of the cooker, 2 persons are required to install it.

### **IMPORTANT**

To minimise the weight of the oven for easier installation, remove the oven door and oven internal accessory pack.

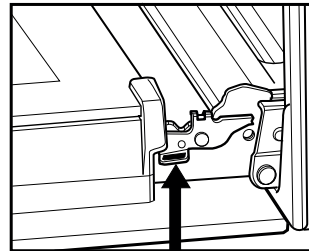

Locking tab up at normal position.

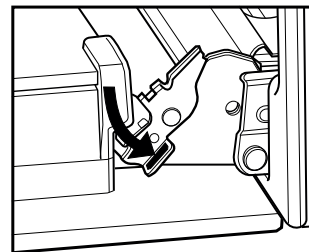

Press the locking tab down for removing the door.

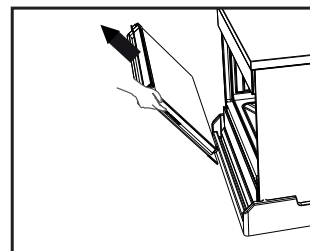

Gently close the door until it comes to a stop. Then lift the door off the hinge.

## Leveling oven

Place a level in the oven as below making sure the level sits on the front and rear forms.

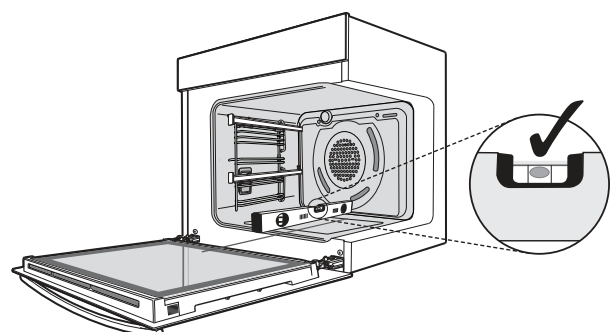

## INSTALLATION (continued)

### Underbench installation

Your underbench oven looks best when the control panel is directly under the benchtop. An upper infill panel may be added if the cooktop placed above the benchtop is too deep.

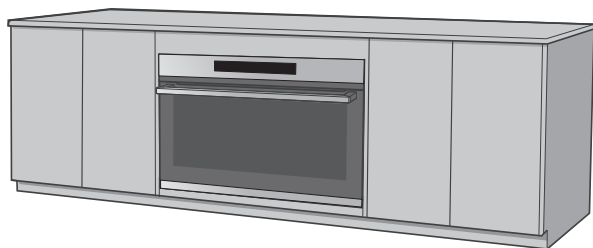

### Vertical cabinet installation

The oven can be built into a vertical cabinet in the same manner as an underbench. The required cavity dimensions are the same and the product is secured to the cabinet in the same way.

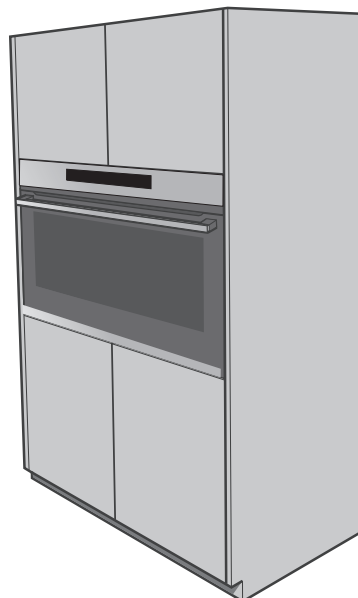

### Oven dimensions

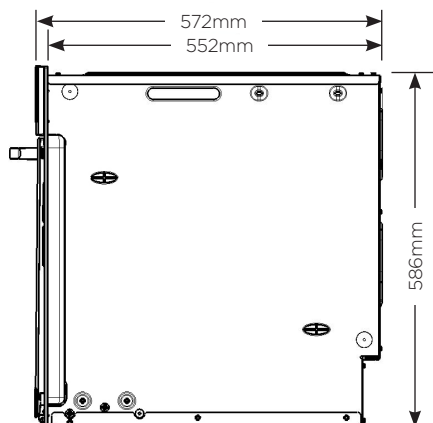
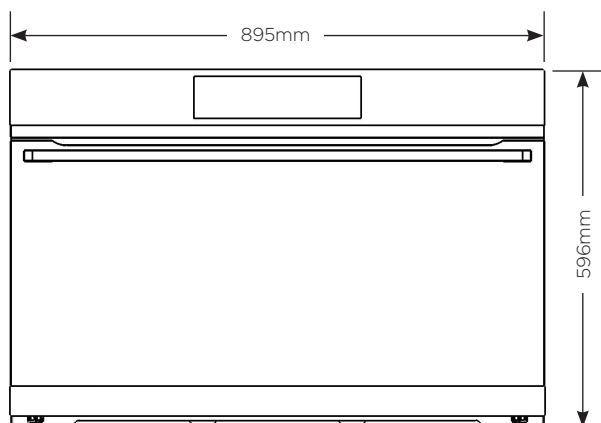

## INSTALLATION (continued)

### Cabinet construction for built in oven

For the best integration within a kitchen, install this appliance in a cupboard that gives a flush fit with the surrounding cupboard fronts. A recess of 20mm is ideal.

*NOTE: Your appliance must be mounted on a horizontal surface for the full width and depth of the product.*

*NOTE: A ventilation slot 20mm wide is required at the rear of the base of the cabinet floor.*

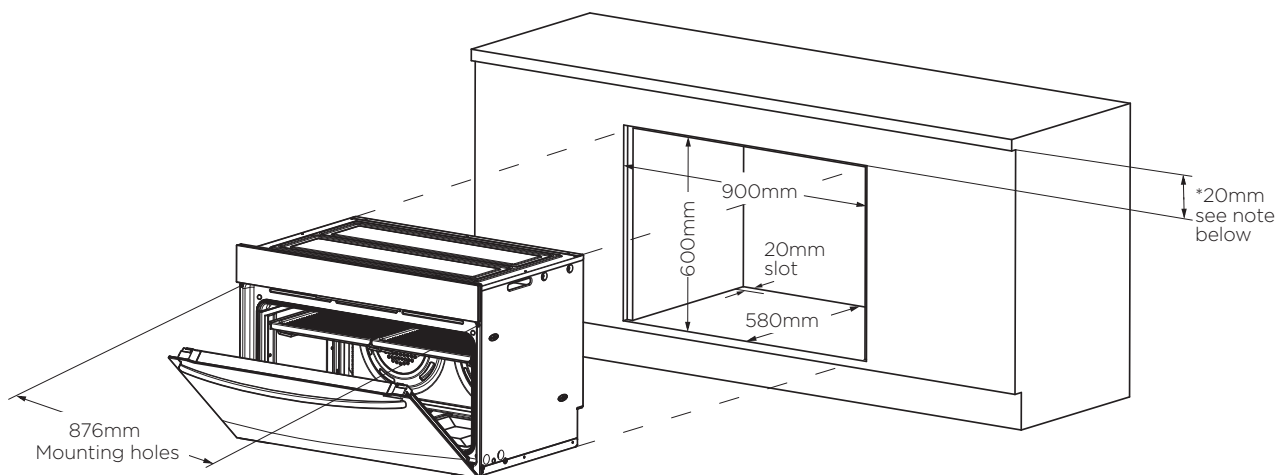
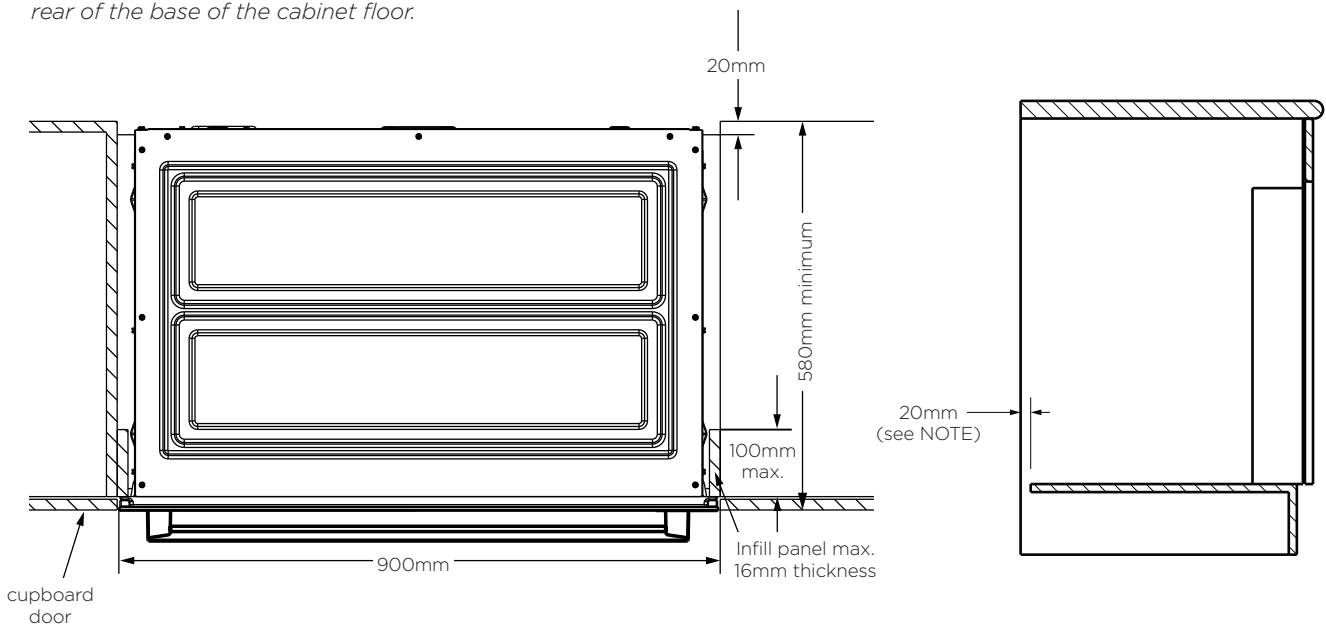

*NOTE: If a powerpoint is fitted it must be accessible with the appliance installed.*

\*Refer to cooktop installation instructions for required clearance between cooktop and oven.



# WIRING REQUIREMENTS

The cooker MUST be installed in compliance with:

- Wiring connections in AS/NZS 3000 Wiring Rules.
- Local regulations, municipal building codes and other statutory regulations.

### For New Zealand Only:

The cooking range must be connected to the supply by a supply cord fitted with the appropriately rated plug that is compatible with the socket-outlet fitted to the final sub-circuit in the fixed wiring that is intended to supply this cooking range.

### Supply cord size required:

WVEP9716SD - 4.0mm<sup>2</sup>

The Data plate gives information about rating and is located behind the bottom of the oven door.

- A functional switch MUST be provided near the appliance in an accessible position (AS/NZS 3000).
- Wiring MUST be protected against mechanical failure (AS/NZS 3000).
- Disconnection in the fixed wiring must occur in accordance with the AS/NZS 3000 wiring rules.
- The cooker MUST be properly earthed.
- This range must be connected with cable of 75°C rating minimum.
- This product has passed the insulation resistance test after manufacture. If the resistance reading is low at installation, it is probably caused by moisture from the atmosphere being absorbed by the elements after the range has been produced. (pass at 0.01 MΩ AS/NZS 3000 Wiring Rules).

*Note: When connections are made to a multi-phase 230/240V supply, the bridge piece MUST be removed from between the active connections.*

### Connecting to services and commissioning

This appliance must be installed by an authorised person, according to all codes and regulations of:

- ELECTRICAL supply authorities.
- Building regulations.
- Local government and council authorities.
- AS/NZS 5601.1.
- AS/NZS 3000.

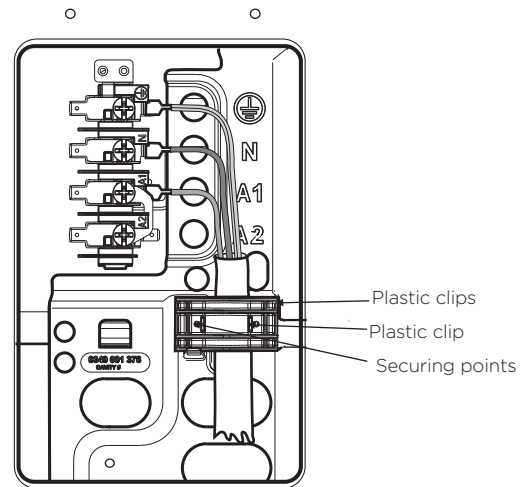

### Hard wiring detail

1. Remove terminal cover plate from rear panel of appliance.
2. Fit wires through hole in back panel below terminal cover.
3. Engage wires into plastic clip. Secure plastic clip with two long silver screws (supplied in separate bag).
4. Replace cover plate onto rear panel.

### Electrical connection location - built-in models

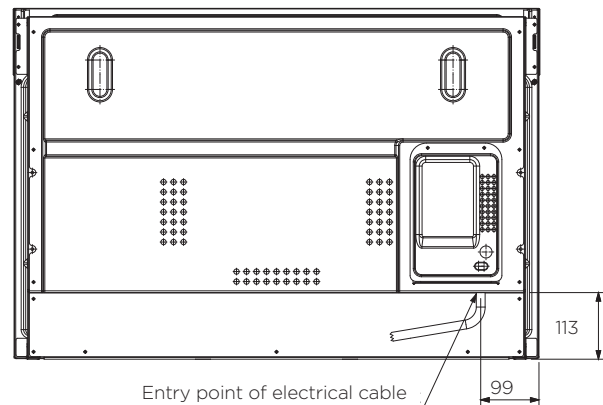

MODEL	TOTAL KW
WVEP9716SD	5.2

# BEFORE OPERATING YOUR APPLIANCE FOR THE FIRST TIME

## Preparing your appliance for the first time

- Please remove all internal boxes and bags from the oven before operation.
- Please wipe out the oven interior prior to operation with warm soapy water and polish dry with a soft clean cloth. Do not close the oven door until the oven is completely dry.
- New appliances can have an odour during first operation. It is recommended to 'run in' your oven before you cook for the first time. Run the oven at 180°C for 2 hours and ensure that the room is well ventilated.
- DO NOT line the oven with foil, it will damage the enamel.
- Prior to installing accessories, remove all packaging and remove plastic film from external panels.

## Setting the time

After electrically connecting the appliance, you must set the time of the day before you can operate your oven.

- After the oven has been electrically connected, '12:00' will be displayed and the hour minute digits will flash.
- Turn the temperature selector (Left - or Right +) to set the time of the day.
- Press OK to complete the clock setting.

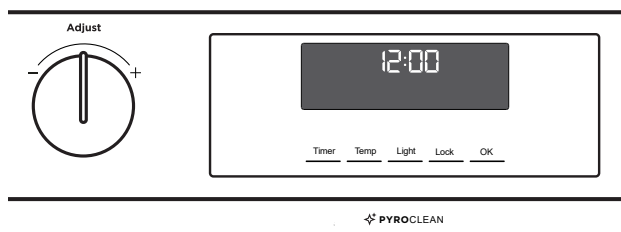

# INSTALLING YOUR OVEN ACCESSORIES

## Slides (telescopic runners) (on selected models)

1. The selected models are supplied with a set of slides and instructions on how to assemble. Ensure the rack and slides are of the same hand, eg. left hand slide should be fitted on the left hand rack.
2. The instructions also show recommended slide positions on the rack.

## Installing the slides (telescopic runners)

1. Obtain left hand side rack and left hand slide - see image to identify

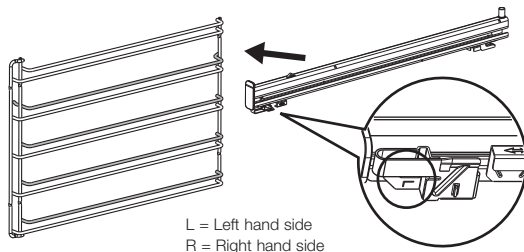

2. The shaded wires indicate the wire the slide can be mounted on. Fit slide rear clips to the rear of wire at an angle as shown below.

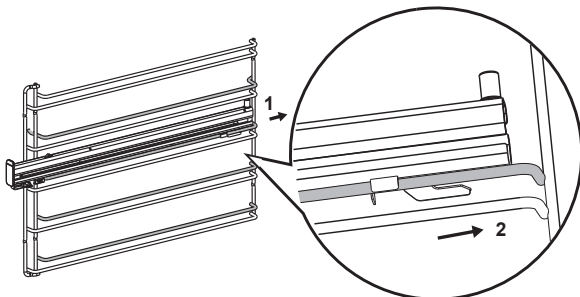

3. Push slide front clip over wire until secured.

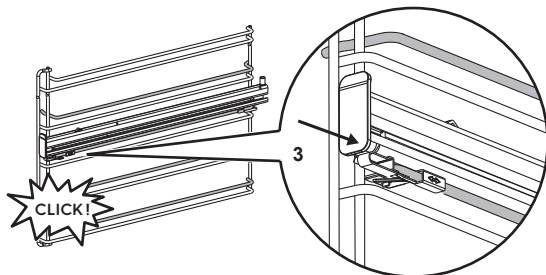

## Installing the side racks

1. Insert the rear peg into the rear access hole

provided, ensuring peg is fully inserted.

2. Then locate the front peg into the front access hole and push in firmly.

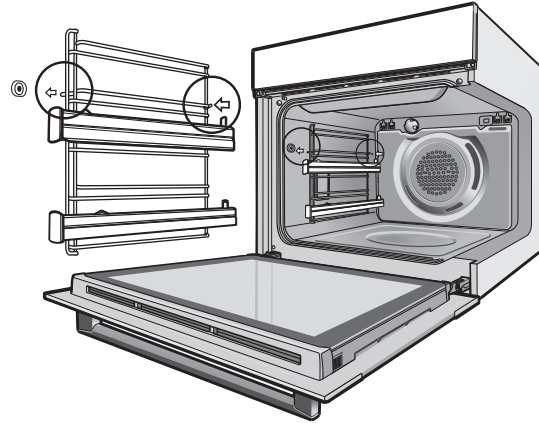

## Fitting the shelves between the side rack wires

The shelves are designed so that they have maximum extension but cannot be accidentally pulled right out.

To fit a shelf to side racks:

1. Locate the rear edge of the shelf in between guide rails of the side rack - see diagram.
2. Ensure the same rail positions on both sides of the oven are being engaged. With the front edge raised, begin to slide the shelf into the oven.
3. Once the detents have passed the front edge of the side rack, the shelf can be pushed completely in. When fully inserted the shelf should not interfere with the closed oven door.

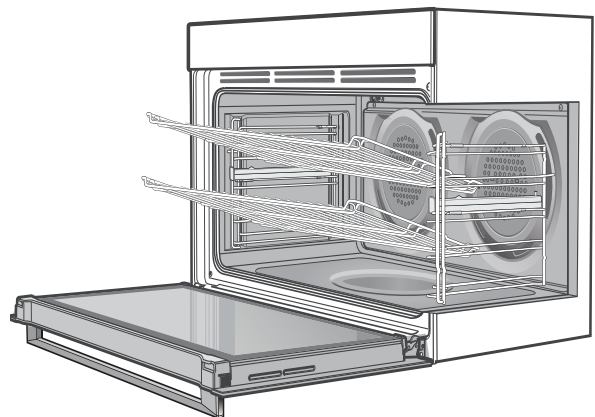

## INSTALLING YOUR OVEN ACCESSORIES (continued)

### Fitting grill dish and insert

Your oven comes with a full width grill dish and a grill insert. The grill dish insert is designed with flexibility to adjust distance between the food and the grill element.

#### Maximum grill power

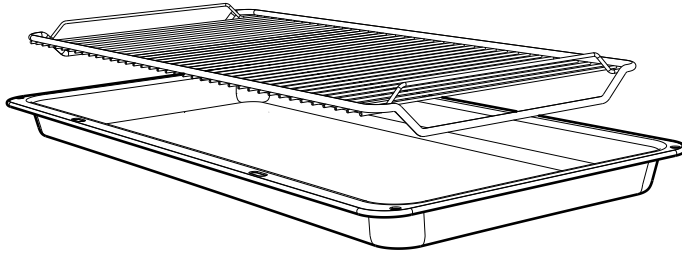

Grill dish insert brings the food closer to the grill element. Suitable when maximum grill power is needed.

#### Moderate grill power

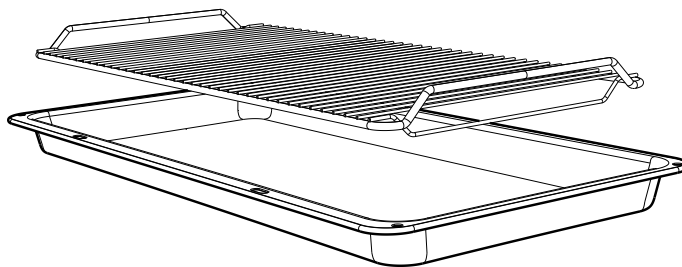

Food sits further away from the grill element. Suitable when moderate grill power is needed.

### Fitting the AirFry

Selected models are supplied with an AirFry. The AirFry system consists of two parts, the outer frame and two mesh trays. The mesh trays sit in the outer frame. The AirFry can be placed onto slides or into side racks in the same manner as an oven shelf.

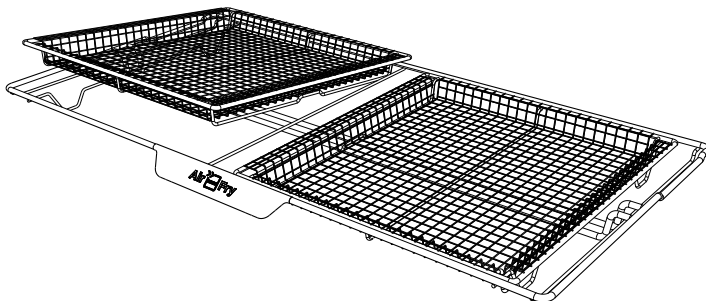

# USING YOUR OVEN

## COOKING FUNCTIONS

Symbol      Function description

<p><b>Fan Forced</b></p> 	<p>Heat comes from the element surrounding the fan. This fan circulates the hot air around the oven cavity so that you can put your food in different places in the oven and still cook them at the same time. You can use 'Fan Forced' function for multi-shelf cooking, reheating cooked foods, pastries and complete oven meals. It will cook at a lower temperature and be faster than baking. Please note that some variation in browning is normal.</p>
<p><b>EasyBake + Steam</b></p> 	<p>EasyBake + Steam adds humidity at the beginning of the baking process. In bakery products, this allows the dough to rise and helps create a moist interior while obtaining a golden and crispy crust. Before preheating, when the oven is cold, add water to the cavity well. Refer to chapter 'Steam assisted cooking' for more details. For best results preheat the empty oven for 10 minutes prior to inserting food.</p>
<p><b>Bake</b></p> 	<p>Heat comes from two elements, one above and one below the food. The bottom element is a clean heat element and is below the floor of the oven. Both elements are controlled by the thermostat and will turn on and off to maintain set temperature. You can use the 'Bake' function for single trays of biscuits, scones, muffins, cakes, slices, casseroles, baked puddings, roasts and delicate egg dishes.</p>
<p><b>Pizza</b></p> 	<p>'Pizza' is a combination of 'Base Heat' and 'Fan Forced' and offers you the combined benefits of both functions. Heat comes from the element surrounding the fan as well as the clean heat element below the oven floor. The 'pizza' function is ideal for foods that require cooking and browning of the base. It is great for foods such as pizzas, quiches, meat pies and fruit pies. Simply put the food in the middle of the oven and select the desired temperature.</p>
<p><b>AirFry</b></p> 	<p>Air fry enables advanced convection cooking function without having to turn the food, giving crispy great tasting results in a shorter time without all the oil. This is suitable for french fries, chicken wings, nuggets and similar products.</p>
<p><b>Base Heat</b></p> 	<p>Heat comes from the clean heat element below the food. The element is controlled by the thermostat and will turn on and off to maintain the set temperature. The 'Base Heat' function can be used to add extra browning to the bases of pizzas, pies, and pastries. Cook in the lower half of the oven when you are using only one shelf.</p>
<p><b>Fan &amp; Grill</b></p> 	<p>'Fan &amp; Grill' offers you the benefits of both 'Bake' and traditional 'Grill' functions. The grill element turns on and off to maintain set temperature while the fan circulates the heated air.</p> <p>Fan grill with the oven door closed.</p> <p>You can use 'Fan &amp; Grill' for large cuts of meat, which gives you a result that is similar to 'roisserie' cooked meat. Put your food on the grill shelf in position 2. When using 'Fan &amp; Grill' it is not necessary to turn food over during the cooking cycle. Set temperature to 180°C.</p>
<p><b>Grill</b></p> 	<p>'Grill' function directs radiant heat from the powerful upper element onto the food. You can use the 'Grill' function for tender cuts of meat, steak, chops, sausages, fish, cheese toasties and other quick cooking foods.</p> <p>Grill with the oven door closed.</p> <p>Preheat your grill for 3 minutes to get the best results. This will help seal in the natural juices of steak, chops etc for better flavour. Place the grill shelf in position 4 with grill dish below to catch any spills.</p>
<p><b>Maxi Grill</b></p> 	<p>'Maxi Grill' directs radiant heat from 2 powerful upper elements onto the food. You can use the 'Maxi Grill' function for tender cuts of meat, steak, chops, sausages, fish, cheese toasties and other quick cooking foods.</p> <p>Grill with the oven door closed.</p> <p>'Maxi Grill' allows you to take full advantage of the large grill dish area and will cook faster than normal 'Grill'. For best results it is recommended to preheat your grill for 3 minutes. This will help seal in the natural juices of steak, chops etc for a better flavour. Place the grill shelf in position 4 with grill dish below to catch any spills.</p>

# USING YOUR OVEN (continued)

## OPERATING SEQUENCE

Select the oven function

Turn the oven function selector clockwise to select the desired oven function.

NOTE: each oven function has a default temperature which can then be adjusted as outlined below.

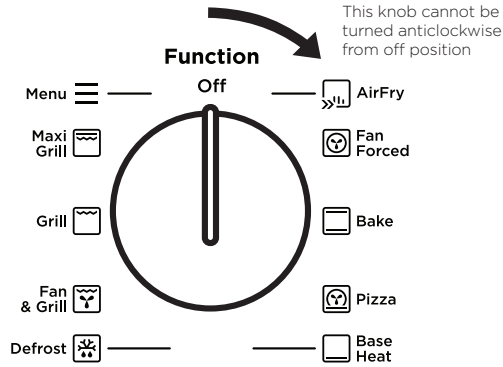

Selecting the oven temperature

Rotate the Adjust selector (left - or right +) as required to set the desired cooking temperature in °C.

NOTE: the temperature can be adjusted at any time throughout the cooking time.

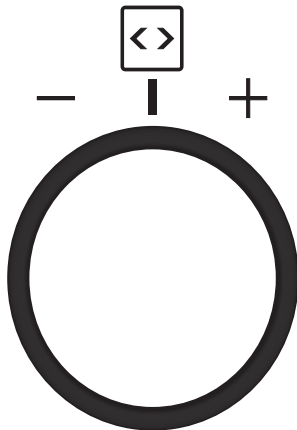

## USING THE APPLIANCE

Control panel

Control panel sensor fields	
<b>Timer</b>	Oven Timer
<b>Temp</b>	Fast heat up
<b>Light</b>	Oven Light
<b>Lock</b>	Child lock
<b>OK</b>	Confirm selection
Legend	
	Press
	Turn the knob

Select a heating function to turn on the oven.

Turn the function selector to the off position to turn the oven off.



When the knob for the heating functions is in the off position, the display goes to standby.

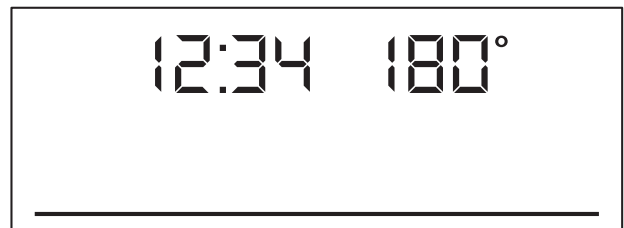

When you cook, the display shows the set temperature, time of day and other available options.

## USING YOUR OVEN (continued)

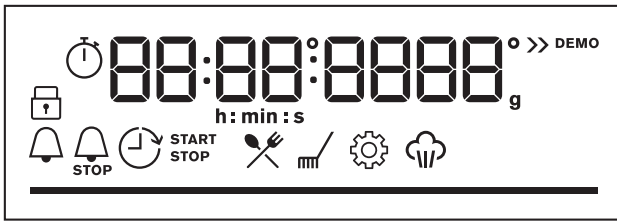

The display with the maximum number of functions set.

### Display indicators

	Lock
	Assisted cooking
	Cleaning
	Settings
	Fast heat up
	Progress bar for temperature or time
	Steam cooking indicator
Timer indicators	
	Minute minder
	Cooking time
	Time delay
	Uptimer

## BEFORE FIRST USE



WARNING

Refer to safety chapters.

Initial cleaning

Before the first use, clean the empty oven and set the time:

	Remove all accessories and removable shelf supports from the oven.
	Clean the oven and accessories with a soft cloth, warm water and a mild detergent.
	Place the accessories and the removable supports in the oven.
	Set the time. Press OK.
<b>00:00</b>	

## CONDITION THE OVEN (TO BURN OFF ANY RESIDUE)



Run in the empty oven before the first use.

1. Remove all accessories and removable shelf supports from the oven.
2. Set the temperature to 180 ° C for the function: Fan cooking . Let the oven operate for 30 minutes.

The oven can emit an odour and smoke during burn off. Make sure that the room is ventilated.

**DAILY USE**

Start cooking

1. Set a heating function.

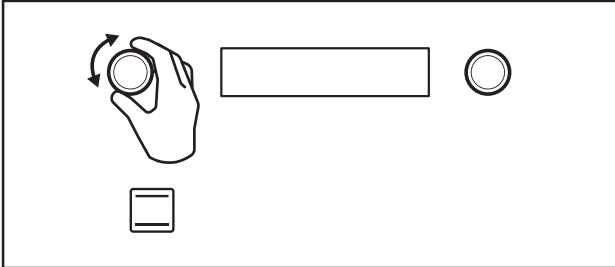

2. Set the temperature.

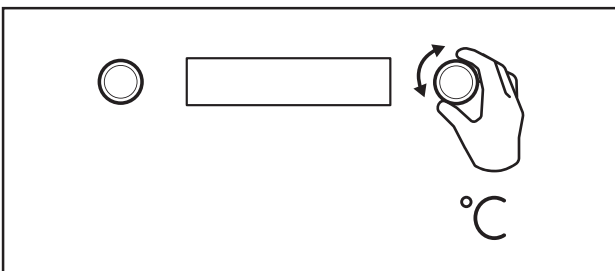

How to set: Assisted Cooking

Every dish in this submenu has a recommended function and temperature. You can adjust the time and the temperature during cooking.

The degree to which a dish is cooked:

- Rare
- Medium
- Well done

Assisted Cooking – use it to prepare a dish quickly with default settings:

1. Enter the menu

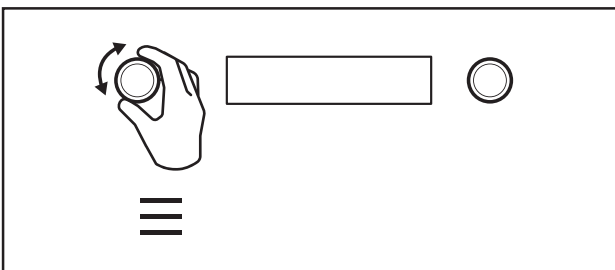

2. Select Assisted Cooking. Press OK.

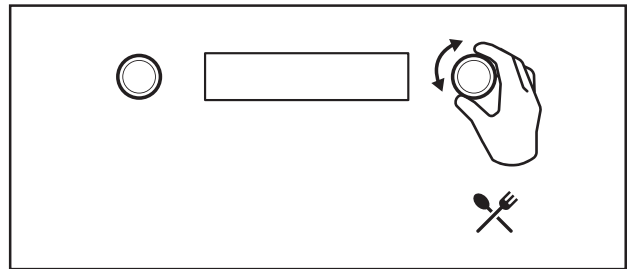

3. Select the dish. Press OK. Refer to “Menu structure” chapter.

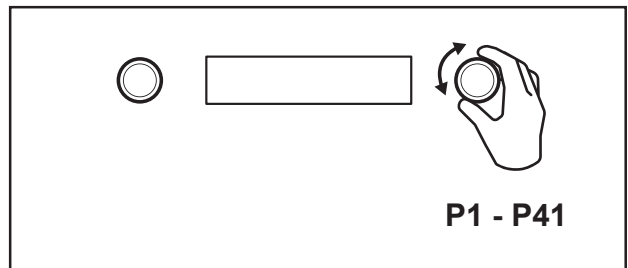



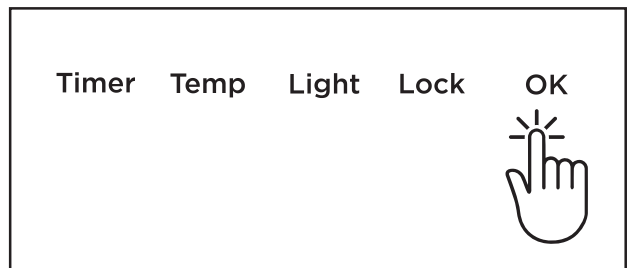

4. Insert the dish into the oven. Confirm setting.





## USING YOUR OVEN (continued)

### CLOCK FUNCTIONS

Clock function	Application
	Minute minder. When the timer ends, the signal sounds.
	Cooking time. When the timer ends, the signal sounds and the heating function stops.
	Time Delay. To postpone the start and/or end of cooking.
	Uptimer. Maximum is 23 hours 59 minutes. This function has no effect on the operation of the oven. To turn the Uptimer on and off, select: Menu, Settings.

How to set: clock functions

How to set: Time of day

1. Turn Function Selector to Menu 

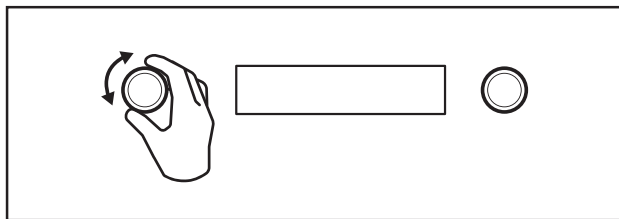

2. Turn Adjust Selector to select Settings  and Press OK.

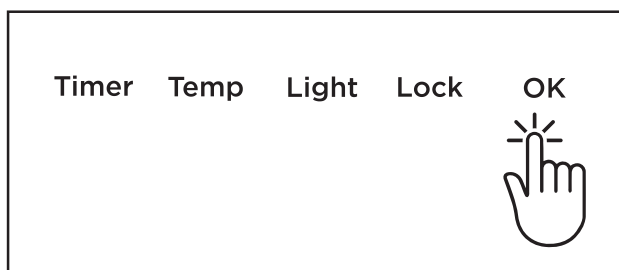
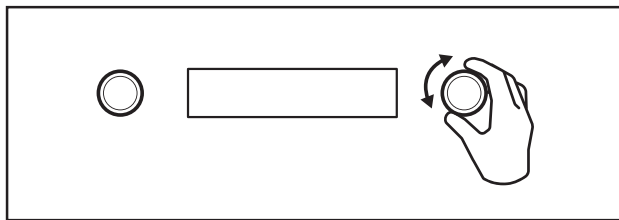

3. Press OK again.

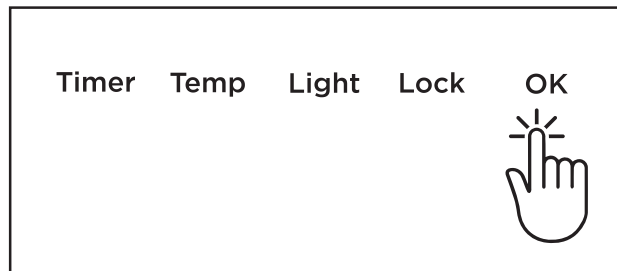

4. Rotate Adjust Selector until the current time is reached. Press OK.

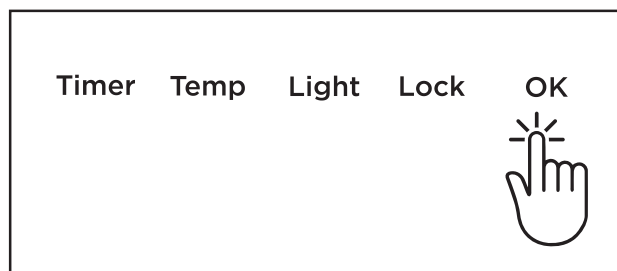
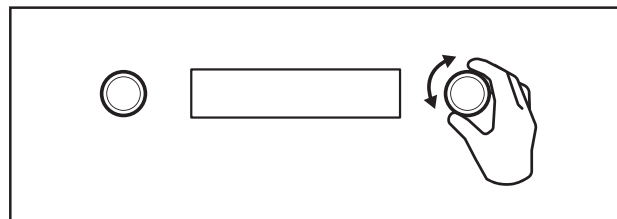

5. Turn Function Selector to Off.

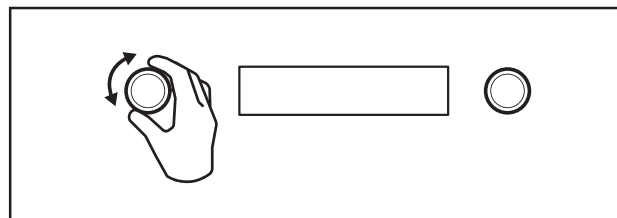

6. After 6 seconds has elapsed, the time is set.

How to set: Minute minder

1. Press: Timer

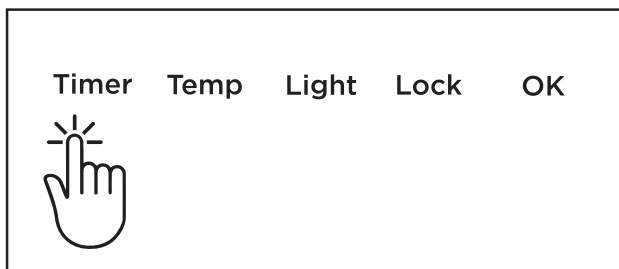

The display shows:

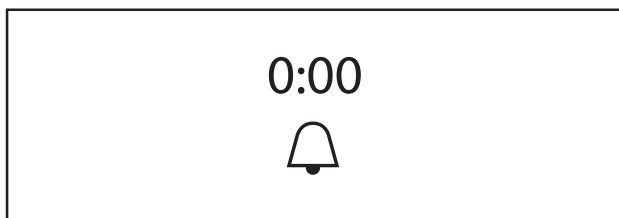

2. Set the Minute minder

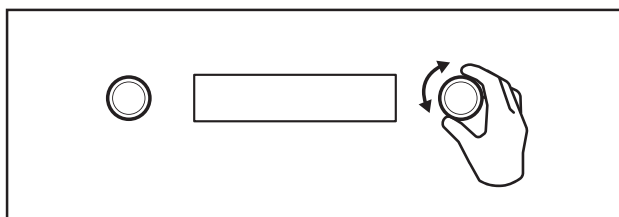

3. Press OK.

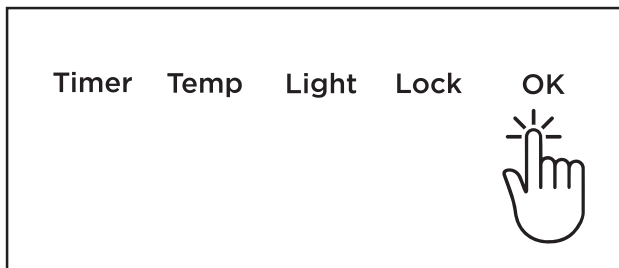

**i** Timer starts counting down immediately.

How to set: Cooking time

1. Choose a heating function and set the temperature.

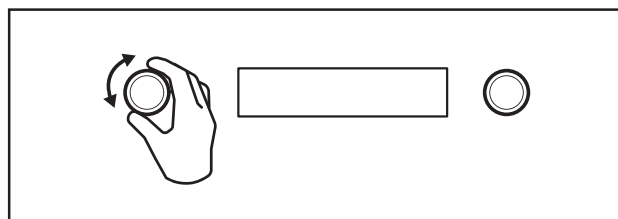

2. Press repeatedly: Timer

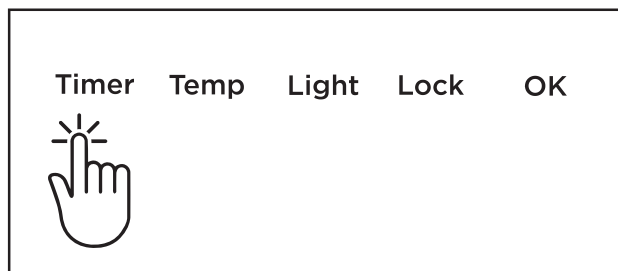

The display shows:



3. Set the cooking time.

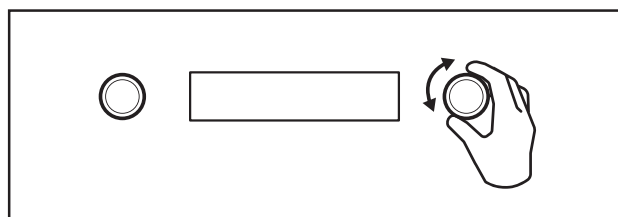

4. Press OK.

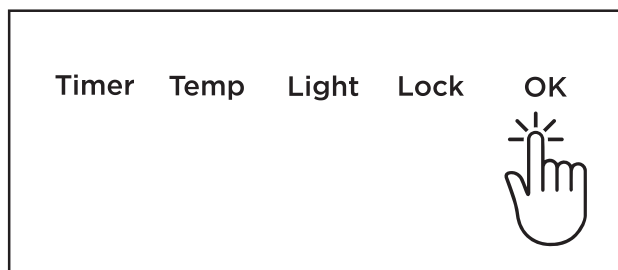

**i** Timer starts counting down immediately.

How to set: Time Delay

1. Select the heating function.

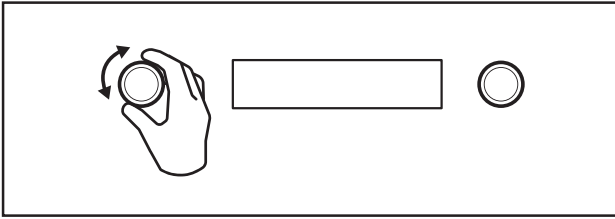

2. Press repeatedly: Timer

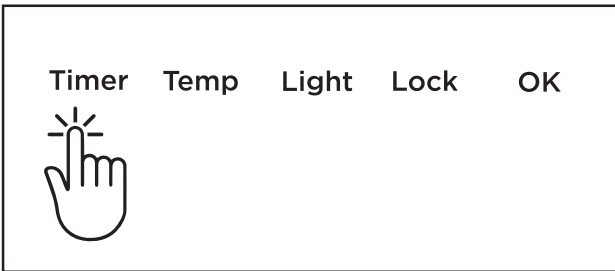

The display shows: the time of day



3. Set the start time.

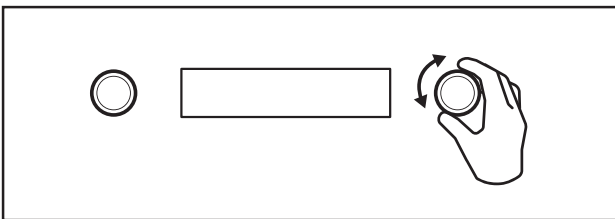

4. Press OK.

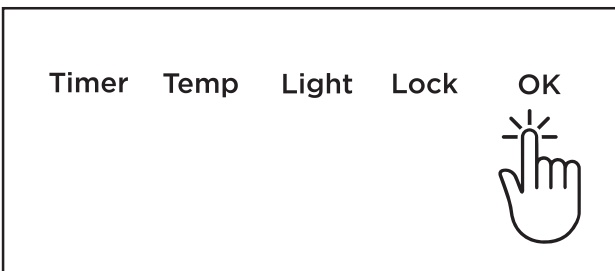

The display shows:

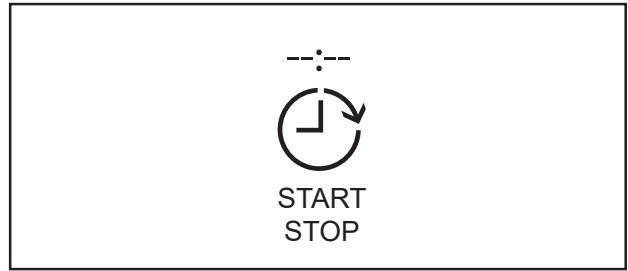

5. Set the end time.

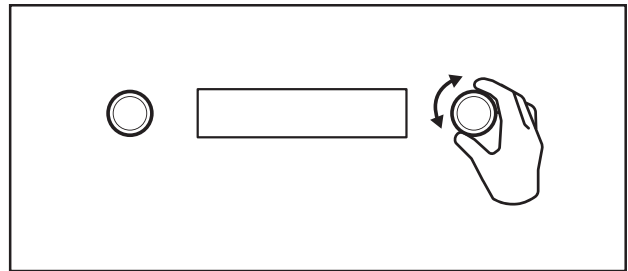

6. Press OK.

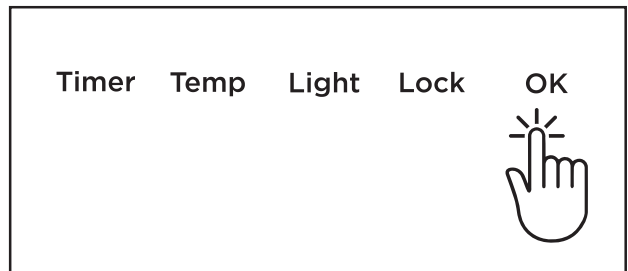

**i** Timer starts counting down immediately.

How to set: Child lock

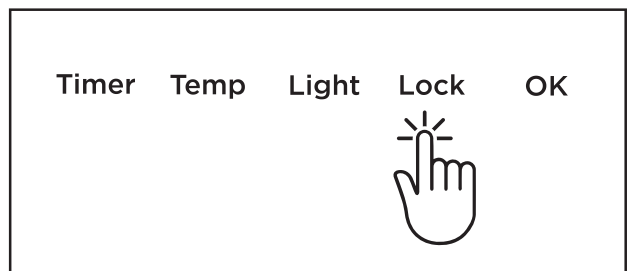

1. Press and hold Lock to turn Child Lock ON/OFF.

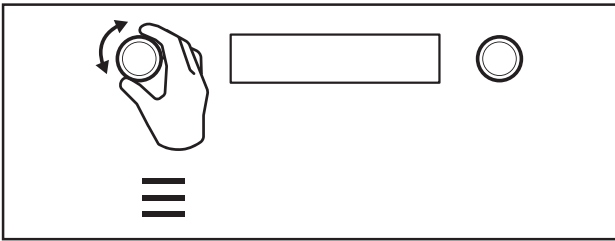

How to change: Settings

Select 



Menu structure	
	Assisted cooking
	Cleaning
	Settings

1. Select Settings.

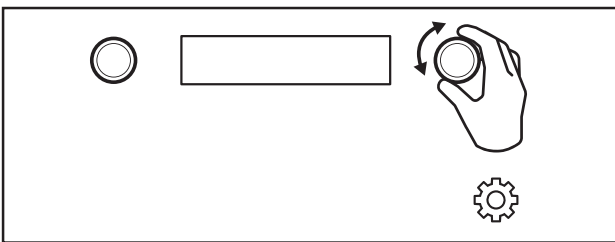

2. Press OK.

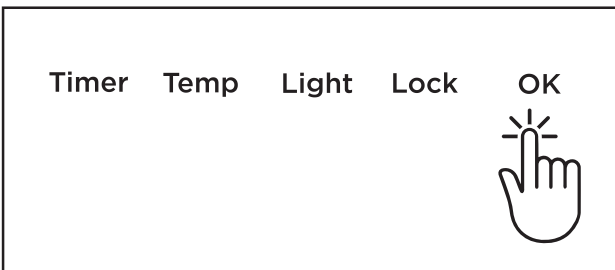

3. Select the required setting 01 to 11

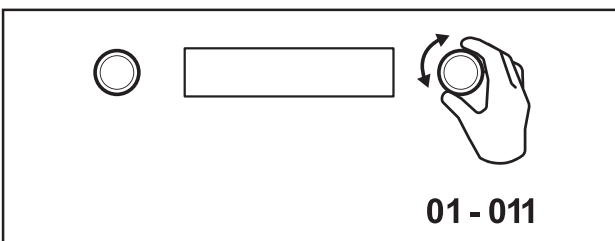

4. Press OK to confirm selection.

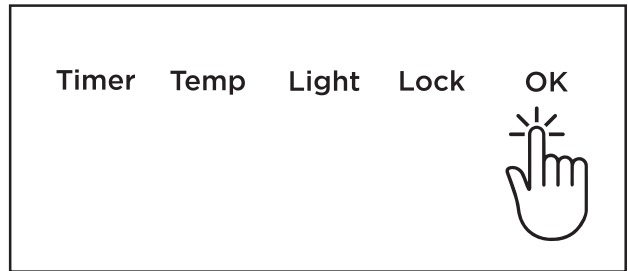

5. Adjust the value and press OK.

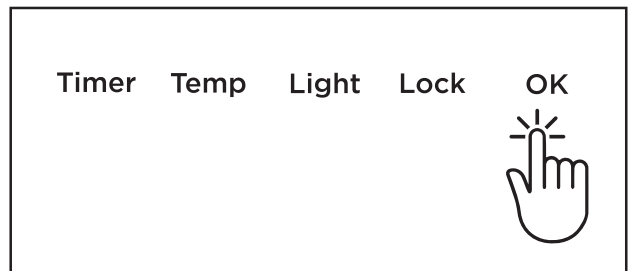
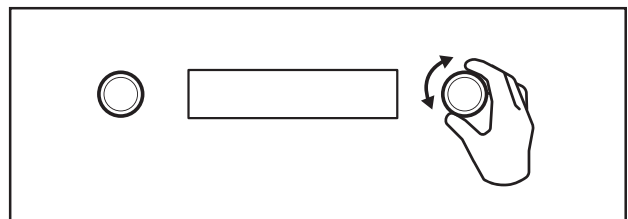

Settings		
1	Time of Day	Change
2	Display Brightness	Change
3	Key Tones	1 - Beep
		2 - Click
		3 - Sound off
4	Buzzer Volume	1 - 4
5	Uptimer	On/off
6	Light	On/off
7	Fast Heat Up	On/off
8	Cleaning Reminder	On/off
9	Demo Mode	Activation code: 2468
10	Software Version	Check
11	Reset All Settings	Yes/No

## ASSISTED COOKING SETTINGS

P1	Jacket Potato Wedges
P2	Hash Browns
P3	Lasagne
P4	Potato Gratin
P5	Pasta Bake
P6	Vegetable Gratin
P7	Pizza
P8	Pizza frozen
P9	Quiche
P10	Ciabatta
P11	Rolls
P12	Baguette
P13	Wholegrain Bread
P14	White Bread
P15	Dark Bread
P16	Almond Cake
P17	Apple Pie
P18	Baked Cheesecake
P19	Apple Cake, covered
P20	Short crust pastry case
P21	Sponge flan case
P22	Madeira Cake
P23	Sponge Cake
P24	Tarts
P25	Apple Strudel, froz.
P26	Baked Cheesecake
P27	Christmas Stollen
P28	Sponge Cake
P29	Sugar Cake
P30	Swiss Roll
P31	Swiss Tarte, sweet
P32	Yeast Cake
P33	Brownies
P34	Cakes, small
P35	Cream Puffs
P36	Eclairs
P37	Macaroons
P38	Muffins
P39	Pastry Strips
P40	Puff Pastry
P41	Shortbread

## EASY BAKE STEAM

Your oven has the ability to add steam while baking. Cooking with steam is a great addition to straight 'hot air' cooking. Steam brings out all the natural flavours and goodness in the food, cooks evenly from surface to centre and retains more nutrients and vitamins. Steam assisted cooking consistently produces juicy, succulent interiors with crisp, golden exteriors.

### **WARNING**

Risk of burns and damage to the appliance.

- Do not open the appliance door when the steam function operates, with the exception of preheating.
- Open the appliance door with care after the steam function stops.
- Refer to cleaning the appliance for cleaning after the steam function operates.

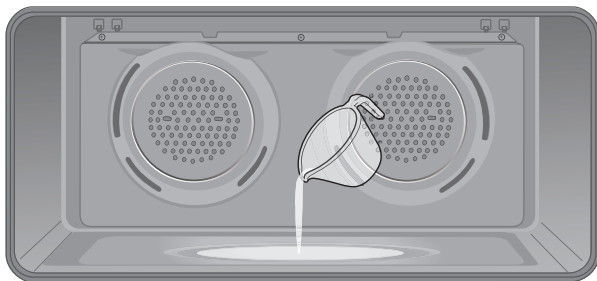

1. Open the oven door.
2. Fill the cavity well with 200ml of water (only when the oven is cold).
3. Set the 'Easy Bake Steam' function.
4. Set the temperature using the  $\wedge$  and  $\vee$  symbols.
5. Preheat the oven for 10 minutes or according to the recipe suggestions.
6. Place food in the appliance and close the oven door.

### **CAUTION**

Do not refill the cavity well with water during cooking or when the oven is hot to avoid damage to enamel.

### **WARNING**

Make sure that the appliance is cool before you remove the remaining water from the cavity well.

## COOKING TEST

### Get to know your new oven with this 'Simple Test Cake'

Although we strive for a perfect performing oven, it's possible that there will be some variation in colour when baking. Therefore, we suggest this simple, easy and delicious to make Simple Test Cake, it can help you understand your new oven. All ovens do sometimes have hot or cold spots, therefore it is important to judge with your eye as you may require to rotate during baking.

#### 'Simple Test Cake'

125g butter, softened to room temperature

1 cup caster sugar

1 teaspoon pure vanilla essence

4 large eggs

2 cups self-raising flour

pinch of salt

4 tablespoons (80ml) full-cream milk

#### Method:

1. Butter base and sides of two 20cm straight-sided round or square cake pans. Then line the base with grease proof or baking paper.
2. Preheat oven to moderate '180°C' (170°C fan forced) and ensure oven shelf is in the centre position of oven.
3. Cream softened butter and sugar until light in colour.
4. Add vanilla essence.
5. Then eggs one at a time, beating well after each addition.
6. Sift flour and salt into the mixture and beat until well combined.
7. Add milk and beat or stir to combine.
8. Spoon mixture equally between prepared cake pans.
9. Bake in preheated oven, middle shelf for about 25 to 35 minutes or until when tested with a fine cake skewer it comes out clean, or the edges of the cakes have come away slightly from the sides of the cake pans.
10. Remove from oven to wire cake rack and rest for 5 minutes before removing from cake pans. Cool completely.

To Serve: sandwich together with your favourite jam or conserve, and dust top with pure icing sugar.

*NOTE: If desired substitute butter for either margarine or olive oil spread. Recipe is based on the Australian standard metric 250ml cup and 20ml tablespoon sets.*

## COOKING GUIDE

- For best baking results preheat oven for 30 minutes.
- Select the correct shelf location for food being cooked.
- The grill tray can be used in the oven as a baking dish.
- Make sure dishes will fit into the oven before you switch it on.
- Keep edges of trays at least 40mm from the side of the oven. This allows free circulation of heat and ensures even cooking.
- Do not open the oven door more than necessary.
- Do not place foods with a lot of liquid into the oven with other foods. This will cause food to steam and not brown.
- After the oven is turned off it retains the heat for some time. Use this heat to finish custards or to dry bread.
- Do not use a lot of cooking oil when roasting. This will prevent splattering oil on the sides of the oven and the oven door. Polyunsaturated fats can leave residue which is very difficult to remove.
- For sponges and cakes use aluminium, bright finished or non-stick utensils.
- Remove unnecessary trays or dishes when roasting or baking.

#### Oven shelf location

Your oven has 5 positions for mounting the shelves or grill dish carrier. These are numbered from 1 (the lowest shelf position) to 5 (the highest shelf position). See diagram.

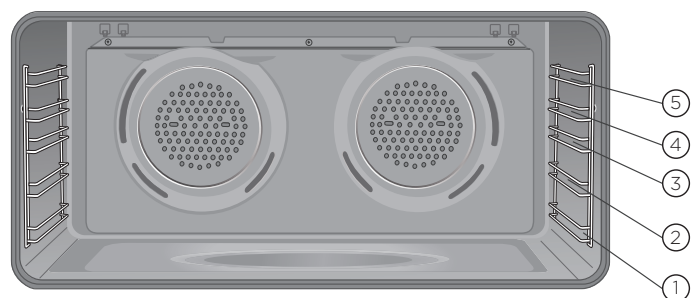

To give maximum space above and below the shelves, load them in this way:

- When cooking with 1 shelf, use position 2 or 3.
- When cooking with 2 shelves, use position 1 and 3.
- When grilling use position 4 or 5.

*NOTE: Use the oven efficiently, by cooking many trays of food at the same time e.g. 2 trays of scones, small cakes or sausage rolls.*

## Choosing the best oven settings

The following table is intended as a guide and experience may show some variation in cooking times necessary to meet individual requirements. We recommend that you preheat your oven for 30 minutes.

### Modes without oven fan

FOOD		TEMPERATURE °C	OVEN SHELF POSITION*	TIME IN MINUTES
Scones	Plain or fruit	220	2 or 3	10 - 15
Biscuits	Rolled	170	3	13 - 18
	Spooned	190	3	13 - 18
	Shortbread biscuits	160	3	30 - 35
Meringues	Hard - individual	110	3	90
	Soft - individual	180	3	15 - 20
	Pavlova - 6 egg	110	3	75
Cakes	Cup cakes	190	2 or 3	15 - 20
	Sponge - 4 egg	180	2 or 3	20 - 30
	Shallow butter cake	180	3	25 - 30
Pastry - short crust	Cornish pasties	200	3	40 - 45
	Custard tart	200/180	3	Pastry 8/200 Whole tart 10/200 & 20/180
Pastry - choux	Cream puffs	210	3	25 - 30
Yeast goods	Bread	210	3	25 - 30

### Modes with oven fan

FOOD		TEMPERATURE °C	OVEN SHELF POSITION*		TIME IN MINUTES
			SINGLE SHELF	MULTI SHELF	
Scones	Plain or fruit	210	2 or 3	1 & 3	10 - 15
Biscuits	Rolled	150	2 or 3	1 & 3	13 - 18
	Spooned	180	2 or 3	1 & 3	13 - 18
	Shortbread	150	2 or 3	1 & 3	13 - 18
Meringues	Hard - individual	100	2 or 3	1 & 3	90
	Soft - individual	165	2 or 3	1 & 3	15 - 20
	Pavlova - 6 egg	100	2 or 3	1 & 3	75
Cakes	Cup cakes	180	2 or 3	1 & 3	15 - 20
	Sponge - 4 egg	170	2 or 3	1 & 3	20 - 30
	Shallow butter cake	170	2 or 3	1 & 3	25 - 30
	Rich fruit cake	170	2 or 3	1 & 3	60
Pastry - short crust	Cornish pasties	180	2 or 3	1 & 3	40 - 45
	Custard tart	190/170	2 or 3	1 & 3	20 - 30
	Whole tart				Pastry 8/190 Whole tart 10/190 & 20/170
Pastry - choux	Cream puffs	200	2 or 3	1 & 3	25 - 30
Yeast goods	Bread	200	3	1 & 3	25 - 30

\* Counting from the bottom shelf up.



## COOKING GUIDE (continued)

### Easy Bake Steam function

fOOD		WATER IN CAvITY WELL (ML)	TEMPERATURE °C	OvEN ShELf POSITION*	TIME IN MINUTES
Yeast goods	Bread loaves	200	180 - 200	2 or 3	35 - 45
	Bread rolls	200	190 - 210	2 or 3	20 - 25
	Gluten free bread	200	180 - 200	2 or 3	40 - 50
	Pizza (fresh)	200	210 - 220	2 or 3	15 - 20
	Focaccia	200	160 - 170	2 or 3	20 - 30
Biscuits	Rolled	200	160 - 170	2 or 3	10 - 15
	Spooned	200	160 - 170	2 or 3	10 - 15
Scones	Plain or fruit	200	200 - 210	2 or 3	10 - 15
Cake	Cupcakes	200	180	2 or 3	20 - 25
	Sponge - 4 eggs	200	170	2 or 3	20 - 30
	Shallow butter cake	200	170	2 or 3	25 - 30
Pastry - choux	Cream puffs	200	200	2 or 3	20 - 30
Puff pastry		200	200	2 or 3	15 - 20
Frozen croissants		200	170 - 180	2 or 3	15 - 25

\* Counting from the bottom shelf up.

## Air Fry Cooking

The Air Fry feature works best for single baking. Air Fry is suitable for French Fries, Chicken Wings, Chicken Nuggets and similar products. See settings in the table below:



### IMPORTANT

- Air Fry is designed for single shelf cooking.
- Food should be arranged in a single layer on the Air Fry Tray.
- A separate tray should be placed on the bottom shelf position to catch any fat or crumbs dropping from the Air Fry Tray during cooking. **This tray must be removed for normal baking.**
- **Some experimenting may be required to find the best cooking time.**
- Food may need to be removed early and should be checked at minimum recommended bake time.
- Some frozen dense food with cook times less than 15 minutes may require additional baking time.

### To set the Air Fry Function:

1. Arrange food on to the Air Fry tray.
2. Select Air Fry setting and suggested temperature from the table below.
3. For best results pre-heat the oven
4. When the oven reaches the set temperature place the Air Fry tray on the suggested oven shelf position.

*NOTE: Set the minute minder for the minimum suggested time and check for desired results when timer ends.*

5. When cooking is complete turn the oven off.
6. Clean Air Fry after each use. Wash the tray in the sink with warm soapy water and a stainless-steel scourer.

	FOOD	TEMPERATURE °C	OVEN SHELF POSITION*	TIME IN MINUTES
Potatoes	Frozen chips	220	2 or 3	18 - 20
	Potato wedges	220	3	20 - 23
Coated/battered goods	Chicken drummetts/wingettes with a dry rub	220	3	18 - 20
	Fresh Barramundi fillet with a crumb	210	3	18 - 20
Frozen goods	Chicken nuggets	230	3	18 - 20
	Crumbed fish	210	3	18 - 20
	Dim sims	230	3	18 - 20
	Hash browns	230	3	18 - 20
Steak	Scotch fillet, seared first	220	2 or 3	8 - 12 (med/rare)

NOTES:

\* Count shelf position from the bottom up.

*A separate tray should be placed on the bottom shelf position to catch any fat or crumbs dropping from the Air Fry Tray during cooking. This tray must be removed for normal baking.*

## COOKING GUIDE (continued)

### Roasting Meat

- Place the meat in the oven and set the temperature between 180°C and 200°C. (It is recommended to wrap your meats in an oven roasting bag or foil to prevent fats and oils from splattering, making it easier to clean your oven.)
- Use the grill (deep) dish and grill insert. Place the meat on the insert.
- Do not pierce the meat, as this will allow juices to escape.
- When the meat is cooked, take the roast out of the oven, wrap in aluminium foil and leave to stand for about 10 minutes. This will help retain the juices when the meat is carved. The table shows temperatures and cooking times for different kinds of meat. These may vary depending on the thickness or bone content of the meat.

MEAT	RECOMMENDED TEMPERATURE		MINUTES PER KG
Beef	180°C - 200°C	Rare	35 - 40
		Medium	45 - 50
		Well done	55 - 60
Lamb	180°C - 200°C	Medium	40
		Well done	60
Veal	180°C - 200°C	Well done	60
Pork	180°C - 200°C	Well done	60

### Roasting poultry and fish

- Place the poultry or fish in an oven set at a moderate temperature of 180°C.
- Place a layer of foil over the fish for about three quarters of the cooking time.

*NOTE: The table shows temperatures and cooking times for different kinds of fish and poultry. These may vary depending on the thickness or bone content of the meat.*

POULTRY & f ISh	RECOMMENDED TEMPERATURE	MINUTES PER KILOGRAM
Chicken	180°C - 200°C	45 - 50
Duck	180°C - 200°C	60 - 70
Turkey	180°C - 200°C	40 - 45 (<10kg)
		35 - 40 (>10kg)
Fish	180°C - 200°C	20

### Grilling Guide



#### WARNING

**Always clean the grill/oven dish after every use. Excessive fat build up may cause a fire.**

**Grilling is conducted with the oven door closed**

As a method of cooking, grilling can be used to:

- Enhance the flavours of vegetables, fish, poultry and meat.
- Seal the surface of the food and retain the natural juices.

This table shows how to grill different types of meat:

Beef	Tenderloin, rump, sirloin. Brush with oil or melted butter, especially if the meat is very lean.
Lamb	Loin chops, short loin chops, chump chops, and forequarter chops. Remove skin or cut at intervals to stop curling. Brush with oil or melted butter.
Sausages	Prick sausages to stop skin from bursting.
Poultry	Divide into serving pieces. Brush with oil.
Fish	Brush with oil or melted butter and lemon juice.
Bacon	Remove rind. Grill flat.

### Guide to better grilling

Steak	15 - 20 minutes
Chops	20 - 30 minutes
Fish	8 - 10 minutes
Bacon	4 - 5 minutes

No definite times can be given for grilling because this depends on your own tastes and the size of the food. These times should only be used as a guide and remember to turn the food over halfway through the cooking process.

For better grilling results, follow these easy instructions:

- Preheat grill for at least 5 minutes.
- Choose only prime cuts of meat or fish. If the cut is less than 5mm thick it will dry out. If the cut is more than 40mm thick, the outside may burn whilst the inside remains raw.
- Do not place aluminium foil under the food as this prevents fats and oils from draining away, which could result in a fire.
- Baste the food during cooking with butter, olive oil or marinade. Grilled food is better if marinated before cooking.
- Use tongs to turn food as a fork pierces the surface and will let juices escape.

### Fan&Grill

The "Fan&Grill" function assists the grilling process by circulating the heat evenly around the food. The recommended temperature setting is 180°C for all fan grilling functions.

- Place the grill dish on the bottom rack.
- Place meat/poultry on an oven shelf above the grill dish.
- Wipe off any oil or fat which spatters while the oven is still warm.

## DEALING WITH COOKING PROBLEMS

(see also TROUBLESHOOTING)

PROBLEM	CAUSES	REMEDIES
Uneven cooking:	<ul style="list-style-type: none"> <li>• Incorrect shelf position.</li> <li>• Trays not centralised.</li> <li>• Air flow in oven uneven.</li> <li>• Grill/Baking dish affecting thermostat.</li> </ul>	<ul style="list-style-type: none"> <li>- Select shelf that puts food in the centre of the oven.</li> <li>- Centre trays.</li> <li>- Rotate food during cooking.</li> <li>- Remove Grill/Baking dish from oven on bake modes.</li> </ul>
Baked products too brown on top:	<ul style="list-style-type: none"> <li>• Oven not preheated.</li> <li>• Baking tins too large for the recipe.</li> <li>• Baking tins not evenly spaced.</li> <li>• Products not evenly sized or spaced on trays.</li> <li>• Baking temperature too high.</li> </ul>	<ul style="list-style-type: none"> <li>- Preheat the oven.</li> <li>- Use correct size tins.</li> <li>- Stagger baking tins at least 3cm between tins and the oven walls.</li> <li>- Make into same size and shape, &amp; spread evenly over trays.</li> <li>- Lower the temperature.</li> </ul>
Baked products too brown on bottom:	<ul style="list-style-type: none"> <li>• Baking tins too large for the recipe.</li> <li>• Baking tins are dark metal or glass.</li> <li>• Food too low in the oven.</li> <li>• Oven door opened too frequently during baking.</li> <li>• Baking temperature too high.</li> <li>• Grill/Baking dish affecting thermostat.</li> </ul>	<ul style="list-style-type: none"> <li>- Use correct size tins.</li> <li>- Change to shiny, light tins or lower the temperature by 10°C.</li> <li>- Cook one shelf higher.</li> <li>- Don't open the oven door until at least half the cooking time has passed.</li> <li>- Lower the temperature.</li> <li>- Remove Grill/Baking dish from oven on bake modes.</li> </ul>
Cakes have a cracked, thick crust:	<ul style="list-style-type: none"> <li>• Baking temperature too high.</li> <li>• Food too high in oven.</li> <li>• Cake batter over mixed.</li> <li>• Pan too deep.</li> <li>• Baking pans dark.</li> </ul>	<ul style="list-style-type: none"> <li>- Lower the temperature.</li> <li>- Cook one shelf lower.</li> <li>- Mix just long enough to combine ingredients.</li> <li>- Check size of pan and use recommended size.</li> <li>- Change to shiny pans.</li> </ul>
Baked products are pale, flat and undercooked:	<ul style="list-style-type: none"> <li>• Baking temperature too low.</li> <li>• Food too low in oven.</li> <li>• Baking time too short.</li> <li>• Incorrect tin size.</li> </ul>	<ul style="list-style-type: none"> <li>- Raise the temperature.</li> <li>- Cook one shelf higher.</li> <li>- Increase cooking time.</li> <li>- Use correct size tin.</li> </ul>
Cakes fallen in the centre:	<ul style="list-style-type: none"> <li>• Baking temperature too low.</li> <li>• Baking time too short.</li> <li>• Proportions of ingredients incorrect in the recipe.</li> <li>• Opening door too early in baking.</li> </ul>	<ul style="list-style-type: none"> <li>- Raise the temperature.</li> <li>- Increase cooking time.</li> <li>- Check recipe.</li> <li>- Do not open the door until the last quarter of cooking time.</li> </ul>
Roast meat and potatoes not browning in fan oven:	<ul style="list-style-type: none"> <li>• Poor hot air circulation.</li> <li>• Grill/Baking dish affecting thermostat.</li> </ul>	<ul style="list-style-type: none"> <li>- Elevate food onto a rack to allow air circulation.</li> <li>- Remove Grill/Baking dish from oven on bake modes.</li> </ul>
Juices running out of meat:		<ul style="list-style-type: none"> <li>- Do not pierce meat with fork, turn with tongs.</li> </ul>
Grilled meats overcooked on outside and raw in the centre:		<ul style="list-style-type: none"> <li>- Grill at lower insert position.</li> </ul>
Grilled chops and steaks curling:		<ul style="list-style-type: none"> <li>- Cut into fat every 2cm (1").</li> </ul>

# CLEANING YOUR OVEN

## WARNING

- Always switch off power to the oven before cleaning.
- Do not line the bottom of the oven with foil or cookware.
- Do not use steam cleaners.

### Stainless steel

## WARNING

The oven door trim and the control panel are decorated with a special stainless steel that resists finger marks and should only be cleaned with warm water and a mild detergent. Do not use stainless steel cleaners, abrasive cleaners or harsh solvents on these parts.

*NOTE: Make sure you follow the polish or brushing lines in the stainless steel.*

- All grades of stainless steel can stain, discolour or become greasy. You must clean these regularly by following the procedures below if you want your appliance to look its best, perform well and have a long life.
- Care must be taken when wiping exposed stainless steel edges, they can be sharp!
- A suitable cleaner can be purchased from Electrolux Customer Care Centres.

### Glass

- Glass surfaces on doors and control panels are best cleaned immediately after soiling.
- A damp cloth may help remove baked on food deposits.

## WARNING

The door glass on this appliance is made from a tough, durable material that withstands heating and cooling without breaking. However, it must be remembered that it is GLASS, it may break. Treat it accordingly! Should you have any questions about the glass in your new appliance, please contact the customer care centre by dialling 1300 363 640.

Do not use harsh abrasive cleaners or sharp metal scrapers to clean the oven door since they can scratch the surface, which may result in the shattering of glass.

### Oven

- Always keep your appliance clean. Ensure that fats and oils do not accumulate around elements or fans.
- Always keep the oven shelves, baking tray, grill dish and grill dish insert clean, as any fat deposits may catch fire.
- Always wrap your meats in foil or an oven roasting bag to minimise cleaning. Any polyunsaturated fats can leave a varnish-like residue which is very difficult to remove.

### Removing the trays and shelves from your appliance

- Remove trays by simply pull them out taking care not to spill the contents.
- Slide shelves towards you until they reach the front stop.
- Tilt them up at the front to clear the side supports.
- Lift them clear.
- Wash the trays and shelves in hot soapy water.
- Reverse the above steps to put the trays and shelves back again.
- Ensure that they are placed between the 2 support wires.

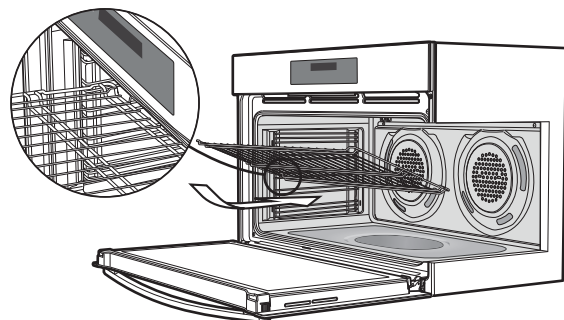

### Removing the side racks or shelf supports

- Grasp the shelf support at the front.
- Pull it firmly inwards

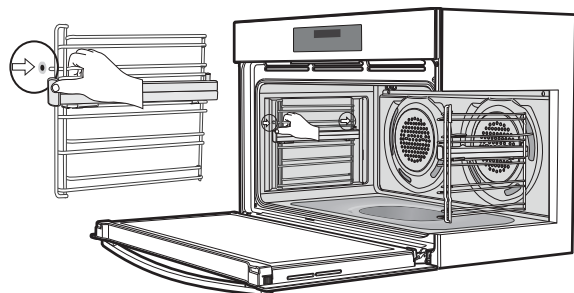

## CLEANING YOUR OVEN (continued)

### Cleaning your oven door

The oven door has been designed to allow the two inner door glasses to be removed for cleaning without removing the door from the product.

Removing the inner door glass for cleaning:

- Open the door fully to gain access to the hinges.
- Push down the hinge locking tab as shown in the diagram on both sides of door.

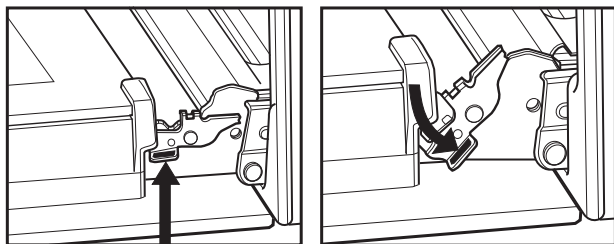

Locking tab up - normal position    Locking tab down - for cleaning

- Gently close the door until it stops in partially open position on the locking tab (the door will not fully close with the locking tab in the down position).
- In this position the top door trim can be removed by pushing each side on the serrated surface to release the clips and lift the trim away from the door.
- To remove the inner glass, tilt top of glass towards the oven and lift out.
- The middle glass is removed in the same way.
- The inner side of outer glass can be cleaned in-situ when inner and middle glass is removed.
- Clean glass using detergent and warm water, wipe clean and dry thoroughly.

Re-assembling the door glass panels:

- Replace the middle glass back to the door. The middle glass is a clear pane and orientation of the glass is not important.
- Replace the inner glass back to the door, ensuring the side with black ceramic paint faces away from the oven cavity when door is closed.
- Fully open the door and return the locking tabs to their normal position and close the door.

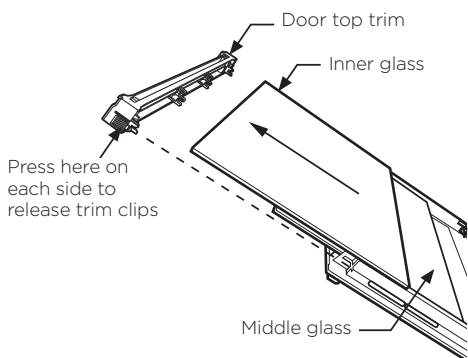

### Cleaning your oven door

#### **WARNING**

- DO NOT use the oven without the inner and middle door glass fitted.
- NEVER spray any caustic cleaners on any surface of the door or damage to the surface coatings will result.
- DO NOT use metal utensils, scrapers, scourers, or abrasive cleaners to clean the glass or any of the door trims. These will damage or scratch the surface coatings and degrade the finish and appearance.
- DO NOT place glass in dishwasher.
- Use only warm water and liquid detergent with a soft cloth to clean the glass or trims.
- Before refitting the glass panes to the door ensure they are dried with a soft cloth.
- The glass edges have been specially ground to remove any sharp edges. However it is glass, and should be handled carefully to avoid injury to yourself and damage to the glass.

#### **WARNING**

Make sure the appliance power is switched off at the isolating switch before you remove or replace parts, to avoid the possibility of electric shock.

### Changing the light globes

- There are 2 light globes located in the top of the oven cavity towards the front. The light globe glass is accessible between the passes of the upper element.
- To remove, turn oven light glass anti-clockwise.
- A special high temperature resistant globe should be used. This can be purchased from the customer care centre.

# CLEANING YOUR PYROLYTIC OVEN

## PYROLYTIC CLEANING THE OVEN

Pyrolytic cleaning of the oven cavity

The oven has the Pyrolytic self-cleaning function. It cleans by burning off the spatters and accumulated dirt and grease from the oven liner, at high temperature. This process produces ash which can then be wiped out of the oven cavity.

Pyrolytic cleaning will not remove salt and mineral residue left in the cavity well when water evaporates. It is recommended that the residue is cleaned prior to conducting pyrolytic cleaning cycles. See section 'Cleaning the cavity well'.

### WARNING

During the pyrolytic cleaning process the oven becomes extremely hot.

- Please keep small children at a safe distance.
- Never clean non-stick baking trays and tins in the oven during the pyrolytic cycle. High temperatures damage the non-stick coating and poisonous gas is released.
- To prevent damage, do not use acids, sprays or similar cleaning agents.

### CAUTION

- During pyrolytic cleaning the air outlet exhaust above the door must be kept clear of any obstruction (eg. bulky tea towels).
- Do not use the oven to clean miscellaneous items (eg. cookware).

Before carrying out the Pyrolytic function

1. All accessories must be removed from the oven, including shelves, trays and side racks.
2. Clean large deposits, spills or grease from the oven cavity.
3. Ensure the cavity well is free of limestone scaling (refer to cleaning the cavity well chapter)
4. Choose the Pyrolytic cleaning cycle from the following:

Cleaning level	duration
C1 - Quick	1 hour 30 minutes
C2 - Normal	2 hours
C3 - Intense	2 hours 30 minutes

NOTE: Duration includes heat-up time, excluding cool-down time.

Light clean

This is an energy saving cycle that can be used on a regular basis if the oven is lightly soiled. Possibly after every 2nd or 3rd roast.

Medium clean

Use this as the regular cycle about once every 2-3 months.

Heavy clean

When the oven is very dirty it may need a longer cycle to clean it thoroughly. This cycle will clean the dirtiest of ovens.

Pyrolytic Cleaning Operation

The pyrolytic cleaning function can be selected by turning the function selector clockwise to the Menu position. Use + or - to select Cleaning and then to select a pyrolytic cleaning time of 1:30hours, 1hour, or 2:30 hours. The pyrolytic function can be stopped at any time by turning the function selector counterclockwise to the OFF position.

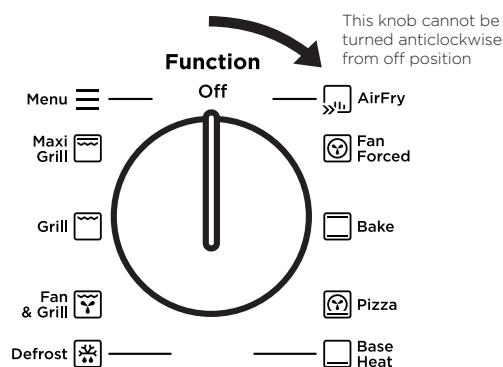

### IMPORTANT

During Pyrolytic cleaning the door will automatically lock and  will appear on the display. During the pyrolytic cleaning cycle there may be some burn off odours. It is advised to keep the room well ventilated during this cycle.

When the pyrolytic cleaning function is on, it is advisable not to use a cooktop if it is fitted above the oven. This could cause overheating and damage to both appliances.

The door will only unlock when the oven has cooled to a safe temperature. Turning the function off will not unlock the door. This will only happen when safe temperature is reached.

NOTE: The cooling fan will operate at an increased speed for Pyrolytic cleaning and will continue to run until the oven has cooled down. This is normal. It is recommended to clean the oven regularly to keep it in its best condition.

After Pyrolytic cleaning

After cool-down, wipe the ash out of the oven with a soft damp cloth and warm water.

To restore the enamel shine to more difficult areas, use a damp cloth with vinegar and detergent.

### CAUTION

Do not turn off the mains power supply to the oven during the pyrolytic cycle. This could damage the appliance.

## TROUBLESHOOTING

### Faults

If there is a problem with the oven and/or grill, please:

- Check the points listed below before calling for service. It may be possible to avoid a call by fixing the problem yourself – and so continue cooking.

*NOTE: We may charge for service even in the guarantee period if your problem is due to the causes listed below.*

PROBLEM	POSSIBLE CAUSE	WhAT TO DO
Oven or grill not working	Power not turned on	Switch on electricity
	Household fuse blown	Check fuses
	Controls incorrectly set	Reset controls
	Circuit breaker tripped	Check circuit breaker
	Clock not set	Set time of day on timer
	Demo Mode 'ON'	Deactivate DEMO Mode. Refer to 'Using your oven'
Oven not heating enough	Child Lock 'ON'	Deactivate Child Lock. Refer to 'Using your oven'
	Foil or trays on bottom of oven	Remove foil or trays
Oven not heating enough	Oven not pre-heated	Pre-heat oven for 30 minutes.
	Light & fans on continuously	Timer not in manual mode
Oven not working	Timer not in manual mode	Set timer to manual mode
	Household fuse blown	Check fuses
Oven light not working	Household fuse blown	Check fuses
	Circuit breaker tripped	Check circuit breaker
	Lamp blown or loose in socket	Replace or tighten lamp
Cooker smoking when first used	Protective oils being removed	Turn grill on high for 30 mins and then the oven on 220°C for 1 hour
Too much condensation building up when baking	Too much water used when cooking	Reduce amount of water
		Leave oven door open after cooking
Smells when first using oven	Protective oils being removed	This is normal
Timer flashing	Power failure or interruption	Reset time of day
Shelf or telescopic runner slides out when door is opened	Oven cavity is not level with the ground.	Perform a check using a level to verify cause (refer to installation section). If not level refer to installer
Oven seal is loose	The oven seal is only attached at each corner. It may seem like a loose fit but when the oven door is closed it will function correctly	No action necessary
There is warm air coming from the top of the oven door	The oven vent is located under the control panel. When the oven is on, the air passes through this vent. This venting is necessary for proper air circulation in the oven and good baking results. Do not block vent.	No action necessary

*NOTE: Only authorised personnel should carry out servicing. If the household fuse continues to blow, call the Customer Care Centre.*

### Further Information

When you need information, service or replacement parts or have a warranty enquiry, please contact the Customer Care Centre:

Australia - 1300 363 640, 8.00am- 5.00pm EST Monday to Friday

New Zealand - 09 573 2384, 8.00am - 5.00pm EST Monday to Friday

Please have the following information ready: Model, Model Number & Serial Number. This is shown on the data plate which is visible when the oven door is open.









FOR SALES IN AUSTRALIA AND NEW ZEALAND  
 APPLIANCE: WESTINGHOUSE BUILT-IN OVENS, COOKTOPS AND  
 FREESTANDING COOKER

**This document sets out the terms and conditions of the product warranties for Westinghouse Appliances. It is an important document. Please keep it with your proof of purchase documents in a safe place for future reference should there be a manufacturing defect in your Appliance. This warranty is in addition to other rights you may have under the Australian Consumer Law.**

**1. In this warranty:**

- (a) 'ACL' or 'Australian Consumer Law' means Schedule 2 to the Competition and Consumer Act 2010;
- (b) 'Appliance' means any Electrolux product purchased by you and accompanied by this document;
- (c) 'ASC' means Electrolux's authorised serviced centres;
- (d) 'Westinghouse' is the brand controlled by Electrolux Home Products Pty Ltd of 163 O'Riordan Street, Mascot NSW 2020, ABN 51 004 762 341 in respect of Appliances purchased in Australia and Electrolux (NZ) Limited (collectively "Electrolux") of 3-5 Niall Burgess Road, Mount Wellington, in respect of Appliances purchased in New Zealand;
- (e) 'Warranty Period' means the period specified in clause 3 of this warranty;
- (f) 'you' means the purchaser of the Appliance not having purchased the Appliance for re-sale, and 'your' has a corresponding meaning.

**2. Application:** This warranty only applies to new Appliances, purchased and used in Australia or New Zealand and is in addition to (and does not exclude, restrict, or modify in any way) other rights and remedies under a law to which the Appliances or services relate, including any non-excludable statutory guarantees in Australia and New Zealand.

**3. Warranty Period:** Subject to these terms and conditions, this warranty continues in Australia for a period of 24 months and in New Zealand for a period of 24 months, following the date of original purchase of the Appliance.

**4. Repair or replace warranty:** During the Warranty Period, Electrolux or its ASC will, at no extra charge if your Appliance is readily accessible for service, without special equipment and subject to these terms and conditions, repair or replace any parts which it considers to be defective. Electrolux may, in its absolute discretion, choose whether the remedy offered for a valid warranty claim is repair or replacement. Electrolux or its ASC may use refurbished parts to repair your Appliance. You agree that any replaced Appliances or parts become the property of Electrolux.

**5. Travel and transportation costs:** Subject to clause 7, Electrolux will bear the reasonable cost of transportation, travel and delivery of the Appliance to and from Electrolux or its ASC. Travel and transportation will be arranged by Electrolux as part of any valid warranty claim.

**6. Proof of purchase** is required before you can make a claim under this warranty.

**7. Exclusions:** You may not make a claim under this warranty unless the defect claimed is due to faulty or defective parts or workmanship. This warranty does not cover:

- (a) light globes, batteries, filters or similar perishable parts;
- (b) parts and Appliances not supplied by Electrolux;
- (c) cosmetic damage which does not affect the operation of the Appliance;

- (d) damage to the Appliance caused by:
  - (i) negligence or accident;
  - (ii) misuse or abuse, including failure to properly maintain or service;
  - (iii) improper, negligent or faulty servicing or repair works done by anyone other than an Electrolux authorised repairer or ASC;
  - (iv) normal wear and tear;
  - (v) power surges, electrical storm damage or incorrect power supply;
  - (vi) incomplete or improper installation;
  - (vii) incorrect, improper or inappropriate operation;
  - (viii) insect or vermin infestation;
  - (ix) failure to comply with any additional instructions supplied with the Appliance;

In addition, Electrolux is not liable under this warranty if:

- (a) the Appliance has been, or Electrolux reasonably believes that the Appliance has been, used for purposes other than those for which the Appliance was intended, including where the Appliance has been used for any non-domestic purpose;
- (b) the Appliance is modified without authority from Electrolux in writing;
- (c) the Appliance's serial number or warranty seal has been removed or defaced

**8. How to claim under this warranty:** To enquire about claiming under this warranty, please follow these steps:

- (a) carefully check the operating instructions, user manual and the terms of this warranty;
- (b) have the model and serial number of the Appliance available;
- (c) have the proof of purchase (e.g. an invoice) available;
- (d) telephone the numbers shown below.

**9. Australia:** For Appliances and services provided by Electrolux in Australia: Electrolux goods come with guarantees that cannot be excluded under the Australian Consumer Law. You are entitled to a replacement or refund for a major failure and for compensation for any other reasonably foreseeable loss or damage. You are also entitled to have the Appliance repaired or replaced if the Appliance fails to be of acceptable quality and the failure does not amount to a major failure. 'Acceptable quality' and 'major failure' have the same meaning as referred to in the ACL.

**10. New Zealand:** For Appliances and services provided by Electrolux in New Zealand, the Appliances come with a guarantee by Electrolux pursuant to the provisions of the Consumer Guarantees Act, the Sale of Goods Act and the Fair Trading Act. Where the Appliance was purchased in New Zealand for commercial purposes the Consumer Guarantee Act does not apply.

**11. Confidentiality:** You accept that if you make a warranty claim, Electrolux and its agents including ASC may exchange information in relation to you to enable Electrolux to meet its obligations under this warranty.

**Important Notice**

Before calling for service, please ensure that the steps listed in clause 8 above have been followed.

<b>AUSTRALIA</b>	<b>FOR SERVICE</b> or to find the address of your nearest authorised service centre in Australia <b>PLEASE CALL 13 13 49</b> <small>For the cost of a local call</small>	<b>FOR SPARE PARTS</b> or to find the address of your nearest spare parts centre in Australia <b>PLEASE CALL 13 13 50</b> <small>For the cost of a local call</small>
<b>NEW ZEALAND</b>	<b>FOR SERVICE</b> or to find the address of your nearest authorised service centre in New Zealand <b>PLEASE CALL 0800 10 66 10</b>	<b>FOR SPARE PARTS</b> or to find the address of your nearest spare parts centre in New Zealand <b>PLEASE CALL 0800 10 66 20</b>

For more information on all Westinghouse appliances, or for dimension and installation information, call into your retailer, phone or email our customer care team or visit our website:

**AUSTRALIA**

phone: 13 13 49

email: [customercare@electrolux.com.au](mailto:customercare@electrolux.com.au)

web: [westinghouse.com.au](http://westinghouse.com.au)

**NEW ZEALAND**

phone: 0800 10 66 10

email: [customercare@electrolux.co.nz](mailto:customercare@electrolux.co.nz)

web: [westinghouse.co.nz](http://westinghouse.co.nz)

 and WESTINGHOUSE are trademarks of Westinghouse Electric Corporation. Used under license by Electrolux Home Products Pty Ltd. All Rights Reserved.

© 2023 Electrolux Home Products Pty Ltd  
ABN 51 004 762 341  
W\_MAN\_WVEP9716SD\_A26335601\_A4\_Apr23