

# SOPA6301TN



Category	60cm
Product Family	Oven
Power supply	Electric
Heat source	ELECTRICITY
Cooking method	Thermoseal
Galileo Technology	Traditional pyro
Cleaning system	Pyrolitic
EAN code	8017709314040



## Aesthetics

Aesthetic	Classic	Serigraphy colour	Silver
Colour	Black	Serigraphy type	Symbols
Finishing	Matt	Door	With 2 horizontal strips
Design	Flat	Handle	Linea
Material	Stainless steel	Handle Colour	All black special edition
Glass Type	Eclipse	Logo	Silk screen

## Controls



Display name	CompactScreen	No. of controls	2
Display technology	LCD	Control knobs	Classic
Control setting	Knobs	Controls colour	Matt black

## Programs / Functions

No. of cooking functions	10
--------------------------	----

## Traditional cooking functions

 Static	 Fan assisted	 Circulaire
 Turbo	 Eco	 Large grill
 Fan grill (large)	 Base	 Circulaire + bottom
 Pizza		

## Other functions

 Defrost by time	 Proving	 Sabbath
--	---	---

## Cleaning functions

 Pirolysis
--

## Options



<b>Time-setting options</b>	Delay start and automatic end cooking
<b>Minute minder</b>	Yes
<b>Timer</b>	1
<b>Controls Lock / Child Safety</b>	Yes

<b>Other options</b>	Keep warm
<b>Showroom demo option</b>	Yes
<b>Rapid pre-heating</b>	Yes

## Technical Features



<b>Minimum Temperature</b>	30 °C
<b>Maximum temperature</b>	280 °C
<b>No. of shelves</b>	5
<b>Shelves type</b>	Metal racks
<b>N. of fans</b>	1
<b>No. of lights</b>	2
<b>Light type</b>	Halogen
<b>User-replaceable light</b>	Yes
<b>Light Power</b>	40 W
<b>Light when door is opened</b>	Yes
<b>Lower heating element power</b>	1200 W
<b>Grill element - power</b>	1800 W
<b>Circular heating element - Power</b>	2000 W
<b>Heating suspended when door is opened</b>	Yes

<b>Door opening type</b>	Standard opening
<b>Door</b>	Temperate door
<b>Removable door</b>	Yes
<b>Full glass inner door</b>	Yes
<b>Removable inner door</b>	Yes
<b>Total no. of door glasses</b>	3
<b>Safety Thermostat</b>	Yes
<b>Chimney</b>	Fixed
<b>Cooling system</b>	Tangential
<b>Cooling duct</b>	Single
<b>Usable cavity space dimensions (HxWxD)</b>	353x470x401 mm
<b>Temperature control</b>	Electronic
<b>Cavity material</b>	Ever clean Enamel

## Performance / Energy Label



Energy efficiency class A+  
 Net volume of the cavity 68 l  
 Energy consumption per cycle in conventional mode 1.09 KWh  
 Energy consumption in conventional mode 3.92 MJ

Energy consumption in forced air convection 2.45 MJ  
 Energy consumption per cycle in fan-forced convection 0.68 KWh  
 Number of cavities 1  
 Energy efficiency index 81 %

## Accessories Included



Enamelled tray (20mm) 1  
 Enamelled deep tray (50mm) 1  
 Insert grid 1

Telescopic Guide rails, partial Extraction 1  
 Rack with back and side stop 1

## Electrical Connection

Plug (I) Australia  
 Voltage 220-240 V  
 Current 13 A

Nominal power 3000 W  
 Frequency (Hz) 50/60 Hz  
 Power supply cable length 115 cm

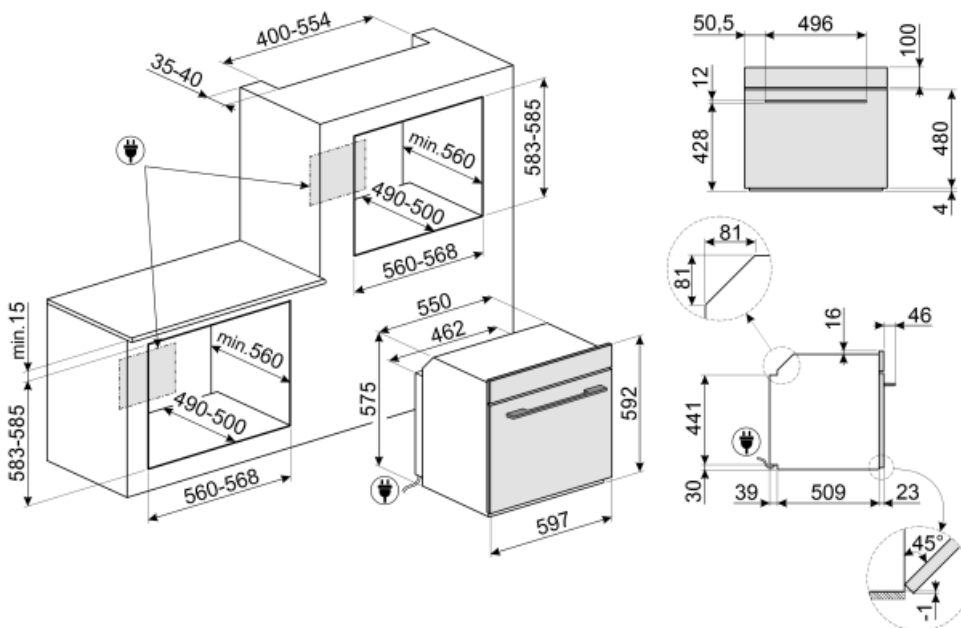

## Not included accessories

---

### AIRFRY

Air fryer rack AIRFRY . Ideal for recreating traditional frying in the oven, but with fewer calories and less fat. It allows you to cook quickly and simply dishes such as French fries, fried vegetables and fish, ensuring perfect browning and crispiness.



## Alternative products





















---













**SOPA6301TX**

Stainless steel

## Symbols glossary (TT)

 <p>Child lock: some models are fitted with a device to lock the programme/cycle so it cannot be accidentally changed.</p>	 <p>Air cooling system: to ensure a safe surface temperatures.</p>
 <p>Defrost by time: with this function the time of thawing of foods are determined automatically.</p>	 <p>...</p>
 <p>Triple glazed doors: Number of glazed doors.</p>	 <p>Electric</p>
 <p>A+: Energy efficiency class A+ helps to save up to 10% energy compared to class A. Maximum performance with minimum consumption is guaranteed.</p>	 <p>Enamel interior: The enamel interior of all Smeg ovens have a special antacid lining which helps keep the interior clean by reducing the amount of cooking grease adhering to it.</p>
 <p>Fan with upper and lower elements: The elements combined with the fan aim to provide more uniform heat, a similar method to conventional cooking, so pre-heat is required. Most suitable for items requiring slow cooking methods.</p>	 <p>Upper and lower element only: a traditional cooking method best suited for single items located in the centre of the oven. the top pf the oven will always be hottest. Ideal for roast, fruit cakes, bread etc.</p>
 <p>Lower heating element only: This function is ideal for foods that require extra base temperature without browning, e.g. pastry dishes, pizza. Also suitable for slow cooking of stews and casseroles.</p>	 <p>Circulaire with lower element: The addition of the lower element adds extra heat at the base for food which requires extra cooking.</p>
 <p>Circulaire: The combination of the fan and circular element around it gives a hot air cooking method. This provides many benefits including no preheat if cook time is more than 20 minutes, no flavour transfer when cooking different foods at the same time, less energy, and shorter cook times. Good for all types of food.</p>	 <p>ECO: The combination of the grill, fan and lower element is particularly suitable for cooking small quantities of food.</p>
 <p>Grill element: Using of grill gives excellent results when cooking meat of medium and small portions, especially when combined with a rotisserie (where possible). Also ideal for cooking sausages and bacon.</p>	 <p>Fan with grill element: The fan reduces the fierce heat from the grill, providing an excellent method of grilling various foods, chops, steaks, sausages etc. giving even browning and heat distribution, without drying out the food. The top two levels recommended for use, and the lower part of the oven can be used to keep items warm at the same time, an excellent facility when cooking a grilled breakfast. Half grill (centre portion only) is ideal for small quantities of food.</p>
 <p>Pizza function: The simultaneous operation of three elements ensures an optimum cooking facility when used with the Smeg pizza stone.</p>	 <p>Circulaire with upper and lower elements: The use of the fan with both elements allows food to be cooked quickly and effectively, ideal for large joints that require thorough cooking. It offers a similar result to rotisserie, moving the heat around the food, instead of moving the food itself, enabling any size or shape to be cooked.</p>
 <p>All glass inner door: All glass inner door, a single flat surface which is simple to keep clean.</p>	 <p>The inner door glass: can be removed with a few quick movements for cleaning.</p>

- 
- |  |  |   |  |
|--|--|---|--|
|  | KEEP_WARM_72dpi  |  | Side lights: Two opposing side lights increase visibility inside the oven.   |
|  | Pyrolytic: Pyrolytic cleaning cycles can be selected as necessary to automatically clean the oven interior.  |  | Air at 40°C provides the perfect environment for proving yeast type dough mixes. Simply select the function and place dough in the cavity for allotted |
|  | Rapid preheat: The rapid preheat function can be used to reach the selected temperature in just a few minutes.   |  | Sabbath: This function allows you to cook food during the Sabbath, the Holiday of rest in the Jewish religion, respecting the precepts. The oven works |
|  | The oven cavity has 5 different cooking levels.  |  | Telescopic rails: allow you to pull out the dish and check it without having to remove it from the oven entirely.                                      |
|  | Electronic control: Allows you to maintain temperature inside the oven with the precision 2-3 ° C. This enables to cook meals that are very sensitive to temperature changes, such as cakes, souffles, puddings. |  | The capacity indicates the amount of usable space in the oven cavity in litres.  |