

SOA4302S3X



Category	45cm compact
Product Family	Oven
Vitality system	Yes
Power supply	Electric
Heat source	ELECTRICITY
Cooking method	Combi Steam
Galileo Technology	Steam100
Cleaning system	Vapour Clean
EAN code	8017709313999



Aesthetics

Aesthetic	Classic	Serigraphy colour	Black
Colour	Stainless steel	Serigraphy type	Symbols
Finishing	Fingerproof	Door	With 2 horizontal strips
Design	Flat	Handle	Classic
Material	Stainless steel	Handle Colour	Steel effect
Glass Type	Eclipse	Logo	Embossed

Controls



Display name	EvoScreen	No. of controls	2
Display technology	LCD	Control knobs	Classic
Control setting	Knobs & touch buttons		

Programs / Functions

No. of cooking functions 12

Traditional cooking functions

 Static	 Fan assisted	 Circulaire
 Turbo	 Eco	 Large grill
 Base	 Pizza	

Cooking functions with steam



Steam



Fan assisted



Circulaire



Sous Vide

Other Steam functions



Tank cleaning



Water outlet



Water input



Descaling

Other functions



Defrost by time



Proving



Stone cooking



BBQ



Air-Fry



Sabbath

Cleaning functions



Vapour Clean

Options



Time-setting options	Delay start and automatic end cooking
Minute minder	Yes
Timer	1

Other options	Keep warm, Eco light, Tones, Brightness
Showroom demo option	Yes
Rapid pre-heating	Yes

Technical Features



Minimum Temperature	30 °C	Full glass inner door	Yes
Maximum temperature	250 °C	Removable inner door	Yes
No. of shelves	2	Total no. of door glasses	3
Shelves type	Metal racks	Soft Close hinges	Yes
N. of fans	1	Soft Open	Yes
No. of lights	1	Safety Thermostat	Yes
Light type	Halogen	Chimney	Variable
User-replaceable light	Yes	Cooling system	Tangential
Light Power	40 W	Cooling duct	Single
Light when door is opened	Yes	Speed Reduction Cooling System	Yes
Lower heating element power	1200 W	Steam range	20 - 100%
Grill element - power	1750 W	Usable cavity space dimensions (HxWxD)	211x462x401 mm
		Temperature control	Electronic

Circular heating element 1400 W
- Power

Heating suspended when door is opened Yes

Door opening type Standard opening

Door Temperate door

Removable door Yes

Cavity material

Water loading

Tank capacity

Ever clean Enamel

Drawer, manual

0,8 l

Performance / Energy Label



Net volume of the cavity 40 l

Number of cavities 1

Accessories Included

Rack with back stop 1

Enamelled deep tray (50mm) 1

Insert gird 1

St/steel tray (20mm) 1

St/steel perforated deep tray (40mm) 1

Other water loading kit

Electrical Connection

Plug (I) Australia

Voltage 220-240 V

Nominal power 3000 W

Frequency (Hz) 50/60 Hz

Power supply cable length 115 cm

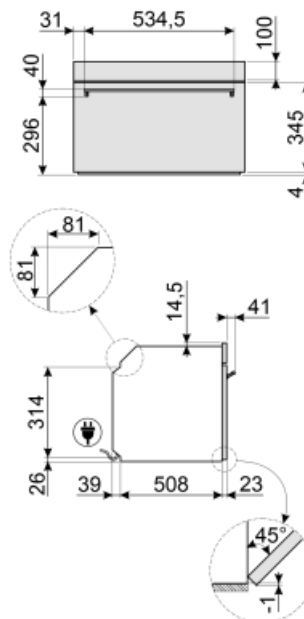
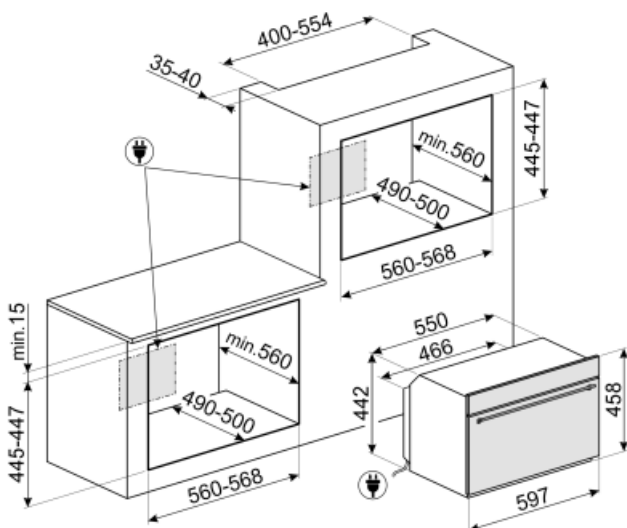

Not included accessories

AIRFRY

Air fryer rack AIRFRY . Ideal for recreating traditional frying in the oven, but with fewer calories and less fat. It allows you to cook quickly and simply dishes such as French fries, fried vegetables and fish, ensuring perfect browning and crispiness.



PR3845X

Antifingerprint stainless steel. Cover for furniture in column installation of more ovens



BX640PL

Stainless steel perforated tray. To cook many types of vegetables, fish, white meats, ravioli or other varieties of stuffed pasta, preserving all the vitamins and mineral salts for a richer, fuller and natural flavour



ET50

Enamelled tray, 50mm deep



ET20

Enamelled tray, 20mm deep



BBQ

Double sided plate BBQ. Suitable for recreating succulent and crispy dishes in the oven with the typical taste of grilled cooking. The ribbed side is particularly suitable for meats and cheeses. The smooth side for fish, seafood and vegetables.



BN640

Enamelled tray, 40mm deep



GTP2

Partially extractable telescopic guides (1 level), suitable for traditional ovens. Made in stainless steel, they guarantee stability and facilitate the smooth extraction of the trays.



PRTX

Refractory pizza stone with handles. D=35cm Not suitable for microwave ovens. Suitable for gas ovens, to be put on the griddle.



BX640

Stainless steel tray for steam oven, H40xW455xD176 mm



BN620-1

Enamelled tray, 20mm deep



GT1P-2

Partially extractable telescopic guides (1 level) for ovens with metal frames. Length: 355.5 mm, extraction: 285 mm. Material: Stainless steel AISI 430 polished.



PALPZ

Pizza shovel with fold away handle width: 315mm length : 325mm



GTTV2

Totally extractable telescopic guides (1 level), suitable for steam ovens. Made in stainless steel, they guarantee stability and facilitate the smooth extraction of the trays.























Alternative products



SOA4302S3N

Black

Symbols glossary (TT)

 <p>Dedicated cooking function for the double sided plate BBQ. Suitable for recreating succulent and crispy dishes in the oven with the typical taste of g</p>	 <p>...</p>
 <p>Combination steam: ovens can be used either as a steam oven, or as a traditional oven, or alternatively the two methods can be combined.</p>	 <p>Air cooling system: to ensure a safe surface temperatures.</p>
 <p>Defrost by time: with this function the time of thawing of foods are determined automatically.</p>	 <p>Descaling function: Is essential to remove excess deposits of limestone in the tank and allow the proper operation of the product. The need to perform this operation is signaled by the product itself.</p>
 <p>Triple glazed doors: Number of glazed doors.</p>	 <p>Automatic lighting switches off: for greater energy savings, the lighting switches off automatically after one minute from the start of cooking.</p>
 <p>Electric</p>	 <p>Enamel interior: The enamel interior of all Smeg ovens have a special antacid lining which helps keep the interior clean by reducing the amount of cooking grease adhering to it.</p>
 <p>Fan with upper and lower elements: The elements combined with the fan aim to provide more uniform heat, a similar method to conventional cooking, so pre-heat is required. Most suitable for items requiring slow cooking methods.</p>	 <p>Upper and lower element only: a traditional cooking method best suited for single items located in the centre of the oven. the top pf the oven will always be hottest. Ideal for roast, fruit cakes, bread etc.</p>
 <p>Lower heating element only: This function is ideal for foods that require extra base temperature without browning, e.g. pastry dishes, pizza. Also suitable for slow cooking of stews and casseroles.</p>	 <p>Circulaire: The combination of the fan and circular element around it gives a hot air cooking method. This provides many benefits including no preheat if cook time is more than 20 minutes, no flavour transfer when cooking different foods at the same time, less energy, and shorter cook times. Good for all types of food.</p>
 <p>ECO: The combination of the grill, fan and lower element is particularly suitable for cooking small quantities of food.</p>	 <p>Grill element: Using of grill gives excellent results when cooking meat of medium and small portions, especially when combined with a rotisserie (where possible). Also ideal for cooking sausages and bacon.</p>
 <p>...</p>	 <p>Dedicated cooking function for the Air fryer rack AIRFRY . Ideal for recreating traditional frying in the oven, but with fewer calories and less fat.</p>
 <p>Pizza function: The simultaneous operation of three elements ensures an optimum cooking facility when used with the Smeg pizza stone.</p>	 <p>FUN_SOUS_VIDE_72dpi</p>

- 

Steam cooking: it's a natural way of cooking for any kind of products, from vegetables to desserts, to preserve the nutritional and organoleptic properties of ingredients. Ideal for cooking without fat, to heat up food without drying. Steam is ideal for simultaneous cooking of meals that require different cooking times.



Fan combined with traditional cooking, where heat is generated from above and below, provides uniform heat. Adding the steam function allows the same cooking results in less time.
- 

Circular element with steam: Cooking with the simultaneous use of the circular heating element in combination with fan and steam supply.



FUN_STEAM_OTHER_WATER_IN_OUT_72dpi
- 

Circular element with upper and lower elements: The use of the fan with both elements allows food to be cooked quickly and effectively, ideal for large joints that require thorough cooking. It offers a similar result to rotisserie, moving the heat around the food, instead of moving the food itself, enabling any size or shape to be cooked.



Compact appliances with a height of 45 cm - perfect solution to meet the functional requirements of kitchen sets of small height. Available in several types and in different styles.
- 

All glass inner door: All glass inner door, a single flat surface which is simple to keep clean.



The inner door glass: can be removed with a few quick movements for cleaning.
- 

KEEP_WARM_72dpi



Side lights: Two opposing side lights increase visibility inside the oven.
- 

Air at 40°C provides the perfect environment for proving yeast type dough mixes. Simply select the function and place dough in the cavity for allotted



Rapid preheat: The rapid preheat function can be used to reach the selected temperature in just a few minutes.
- 

Sabbath: This function allows you to cook food during the Sabbath, the Holiday of rest in the Jewish religion, respecting the precepts. The oven works



The oven cavity has 2 different cooking levels.
- 

Soft close: all models are equipped with advanced function of smooth closing of the door, which allows the device to close smoothly and quietly.



To guarantee the optimal functioning of the appliance, it is suggested to carry out the tank cleaning roughly once every 2-3 months.
- 

Electronic control: Allows you to maintain temperature inside the oven with the precision 2-3 ° C. This enables to cook meals that are very sensitive to temperature changes, such as cakes, souffles, puddings.



Vapour Clean: a simple cleaning function using steam to loosen deposits in the oven cavity.
- 

The capacity indicates the amount of usable space in the oven cavity in litres.



Dedicated cooking function for the rectangular refractory stone PPR2 Dimensions Ideal for cooking pizzas with the same results as a typical wood-fire