

# SI1M7743B



Product Family	Hob
Built-in type	Ultra-low profile
Dimensions	70 cm
Power supply	Electric
Type	Induction
EAN code	8017709254940



## Aesthetics



Aesthetic	Universale
Colour	Black
Finishing	Glass
Material	Glass
Glass type	Ceramic
Glass edge	Bevelled Front Edge
Type of control setting	Multi Slider
Slider	Yes
Slider	Red
Control knob position	Front
Serigraphy colour	Grey

## Programs / Functions



Total no. of cook zones	4
No. of induction cook zones	4
No. of cooking zones with booster	4
No. of Flexible zones	1
Main on/off switch	Yes
Power levels	14
Auto-Vent	Yes

## Options



<b>Multizone Option</b>	Yes	<b>Residual time indicator</b>	Yes
<b>Flexible Zone Type</b>	MultiZone	<b>Limited Power</b>	Advanced Eco Logic
<b>Standard cut out</b>	490x560 mm	<b>Consumption Mode</b>	
<b>End cooking timer</b>	4	<b>Limited Power</b>	1500, 2000, 2500, 3000,
<b>Pause option</b>	Yes	<b>Consumption Mode in W</b>	3500, 4000, 4500, 5000,
<b>Minute minder</b>	4		6000, 7200 W
<b>End of cooking alarm</b>	Yes	<b>Showroom Demo Option</b>	Yes
		<b>Control Lock / Child Safety</b>	Yes
		<b>Rapid level selection</b>	Yes

## Technical Features



Front-left - Induction - Multizone - 2.30 kW - Booster 3.20 kW - Ø 21 cm  
 Rear-left - Induction - Multizone - 2.30 kW - Booster 3.20 kW - Ø 21 cm  
 Front-right - Induction - Single - 1.40 kW - Booster 2.50 kW - Ø 14.5 cm  
 Rear-right - Induction - Single - 1.80 kW - Booster 2.80 kW - Ø 18 cm

<b>Automatic setting according to pan dimension</b>	Yes	<b>Automatic switch off when overflow</b>	Yes
<b>pan detection</b>	Yes	<b>Eco-Heat</b>	Yes
<b>Minimum pan diameter indication</b>	Yes	<b>Eco-Off</b>	Yes
<b>Automatic switch off when overheat</b>	Yes		

## Electrical Connection

<b>Electrical connection rating (W)</b>	7200 W	<b>Frequency (Hz)</b>	50/60 Hz
<b>Voltage (V)</b>	220-240 V	<b>Power supply cable length</b>	150 cm
<b>Voltage 2 (V)</b>	400 V	<b>Terminal box</b>	5 poles
<b>Type of electric cable</b>	Universal		

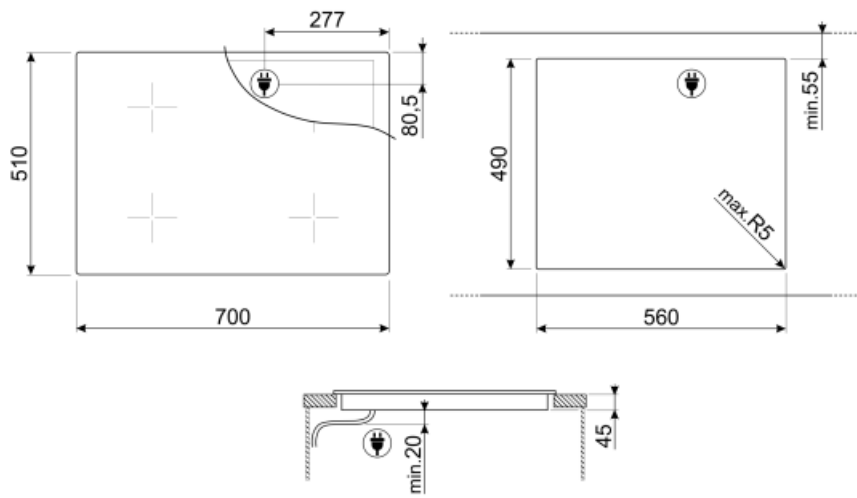

## Not included accessories

---



### GRILLPLATE

Universal griddle for induction, gas, ceramic and electric hobs. Non-stick surface ideal for cooking meat, cheese and vegetables. Dimensions: 410 x 240 mm.



### TPK

Stainless steel grill plate to cook Teppanyaki dishes



### SCRP

















Induction and ceramic hobs and teppanyaki scraper



### TPKPLATE

Universal plate for induction, gas, ceramic and electric hobs. Non-stick surface ideal for cooking fish, eggs and vegetables. Dimensions: 410 X 240 mm.

## Symbols glossary (TT)

 <p>A smart infrared system, which allows a hood and hob with this feature to work together.</p>	 <p>Power booster: option allows the zone to work at full power when very intense cooking is necessary.</p>
 <p>Ultra-low profile: Installation of product with flat edge - height of 1 mm.</p>	 <p>Child lock: some models are fitted with a device to lock the programme/cycle so it cannot be accidentally changed.</p>
 <p>The slider control panel allows you to adjust the power simply by passing your finger across the touch device.</p>	 <p>Eco-Heat: this function warns when the zone is still hot after being switched off. As well as ensuring maximum safety by preventing burns, this also allows you to make use of residual heat to continue cooking or keep foods hot.</p>
 <p>Eco-Off: This energy-saving function shuts the zone down before the timer sounds, making use of the residual heat in the pan.</p>	 <p>Overheat protection: The safety system that automatically turns off the hob in case of overheating of the control unit.</p>
 <p>Induction: The work of these hobs is based on the principle of electromagnetic induction. The heat is generated directly in the bottom of the pan during its contact with the hob.</p>	 <p>Multizone: allows several pans to be used at once, large or small, offering freedom of placement and greater flexibility</p>
 <p>Overfill protection: The special overfill protection shuts down the stove in the presence of overflow of liquids.</p>	 <p>Premium individual Slider control for each zone</p>
 <p>PAUSE_72dpi</p>	 <p>Quick selection, with one touch cooking begins at the highest level, then automatically reduces after time. Ideal for dishes that require quick boiling and then continued cooking without constant control (eg beef broth).</p>
 <p>Time elapsed: shows how long the cooking zone has been in use.</p>	 <p>Timer: All ceramic hobs have a timer which automatically ends cooking after a preset time.</p>
 <p>...</p>	