

SFA63M3TVX



Category	60cm
Product Family	Oven
Power supply	Electric
Heat source	ELECTRICITY
Cooking method	Thermoseal
Cleaning system	Vapour Clean
EAN code	8017709289317



Aesthetics

Aesthetic	Classic	Serigraphy colour	Black
Colour	Stainless steel	Serigraphy type	Symbols and wordings
Finishing	Fingerproof	Door	With 2 horizontal strips
Design	Flat	Handle	Classic
Material	Stainless steel	Handle Colour	Inox
Type of steel	Brushed	Logo	Embossed
Glass Type	Eclipse		

Controls

Control setting	Knobs	Control knobs	Classic
No. of controls	3	Controls colour	Steel effect

Programs / Functions

No. of cooking functions	8
Traditional cooking functions	



Static



Fan assisted



Circulaire



Turbo



Eco



Large grill



Fan grill (large)



Base

Other functions



Defrost

Cleaning functions



Vapour Clean

Options

Time-setting options	Automatic end cooking	Timer	1
Minute minder	Yes		

Technical Features



Minimum Temperature	50 °C	Circular heating element	2000 W
Maximum temperature	250 °C	- Power	
No. of shelves	5	Heating suspended when door is opened	Yes
Shelves type	Metal racks	Door opening type	Standard opening
Tilting grill	Yes	Door	Temperate door
N. of fans	1	Removable door	Yes
No. of lights	1	Full glass inner door	Yes
Light type	Halogen	Removable inner door	Yes
User-replaceable light	Yes	Total no. of door glasses	3
Light Power	40 W	Safety Thermostat	Yes
Light when door is opened	Yes	Cooling system	Tangential
Lower heating element power	1200 W	Cooling duct	Single
Upper heating element - Power	1000 W	Speed Reduction	Yes
Grill element - power	1700 W	Cooling System	
Large grill - Power	2700 W	Usable cavity space dimensions (HxWxD)	360x460x425 mm
		Temperature control	Electro-mechanical
		Cavity material	Ever clean Enamel

Performance / Energy Label

Number of cavities	1
--------------------	---

Accessories Included

Enamelled tray (20mm)	1	Rack with back and side stop	1
Insert gird	1	Enamelled deep tray (40mm)	1

Electrical Connection

Plug	(I) Australia	Nominal power	3000 W
Voltage	220-240 V	Frequency (Hz)	50/60 Hz
Current	13 A	Power supply cable length	115 cm

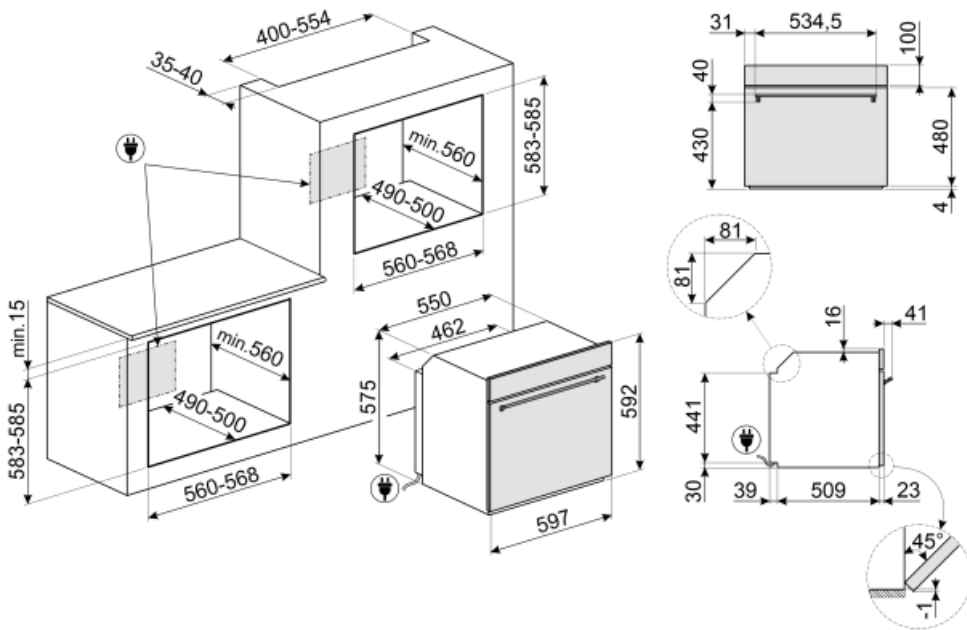

Not included accessories

GTP

Partially extractable telescopic guides (1 level) Extraction: 300 mm Material: Stainless steel AISI 430 polished



PRTX

Refractory pizza stone with handles. D=35cm Not suitable for microwave ovens. Suitable for gas ovens, to be put on the griddle.



GT1P-2

Partially extractable telescopic guides (1 level) for ovens with metal frames. Length: 355.5 mm, extraction: 285 mm. Material: Stainless steel AISI 430 polished.



GTT

Totally extractable telescopic guides (1 level) Extraction: 433 mm Material: Stainless steel AISI 430 polished



PR3845X

Antifingerprint stainless steel. Cover for furniture in column installation of more ovens



BN620-1

Enamelled tray, 20mm deep



PALPZ

Pizza shovel with fold away handle width: 315mm length : 325mm





















BN640

Enamelled tray, 40mm deep



Symbols glossary (TT)

 <p>Air cooling system: to ensure a safe surface temperatures.</p>	 <p>With the switch on this symbol, no heating is possible even if the thermostat is turned.</p>
 <p>Triple glazed doors: Number of glazed doors.</p>	 <p>Electric</p>
 <p>Enamel interior: The enamel interior of all Smeg ovens have a special antacid lining which helps keep the interior clean by reducing the amount of cooking grease adhering to it.</p>	 <p>Fan with upper and lower elements: The elements combined with the fan aim to provide more uniform heat, a similar method to conventional cooking, so pre-heat is required. Most suitable for items requiring slow cooking methods.</p>
 <p>Upper and lower element only: a traditional cooking method best suited for single items located in the centre of the oven. the top pf the oven will always be hottest. Ideal for roast, fruit cakes, bread etc.</p>	 <p>Lower heating element only: This function is ideal for foods that require extra base temperature without browning, e.g. pastry dishes, pizza. Also suitable for slow cooking of stews and casseroles.</p>
 <p>Circulaire: The combination of the fan and circular element around it gives a hot air cooking method. This provides many benefits including no preheat if cook time is more than 20 minutes, no flavour transfer when cooking different foods at the same time, less energy, and shorter cook times. Good for all types of food.</p>	 <p>ECO: The combination of the grill, fan and lower element is particularly suitable for cooking small quantities of food.</p>
 <p>Grill element: Using of grill gives excellent results when cooking meat of medium and small portions, especially when combined with a rotisserie (where possible). Also ideal for cooking sausages and bacon.</p>	 <p>Fan with grill element: The fan reduces the fierce heat from the grill, providing an excellent method of grilling various foods, chops, steaks, sausages etc. giving even browning and heat distribution, without drying out the food. The top two levels recommended for use, and the lower part of the oven can be used to keep items warm at the same time, an excellent facility when cooking a grilled breakfast. Half grill (centre portion only) is ideal for small quantities of food.</p>
 <p>Circulaire with upper and lower elements: The use of the fan with both elements allows food to be cooked quickly and effectively, ideal for large joints that require thorough cooking. It offers a similar result to rotisserie, moving the heat around the food, instead of moving the food itself, enabling any size or shape to be cooked.</p>	 <p>All glass inner door: All glass inner door, a single flat surface which is simple to keep clean.</p>
 <p>The inner door glass: can be removed with a few quick movements for cleaning.</p>	 <p>Side lights: Two opposing side lights increase visibility inside the oven.</p>
 <p>The oven cavity has 5 different cooking levels.</p>	 <p>Tilting grill: the tilting grill can be easily unhooked to move the heating element and clean the roof of the appliance in one simple step.</p>
 <p>Vapour Clean: a simple cleaning function using steam to loosen deposits in the oven cavity.</p>	