

SE364TBAU

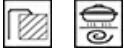

Product Family	Hob
Built-in type	Ultra-low profile
Dimensions	60 cm
Power supply	Electric
Type	Ceramic
EAN code	8017709265748

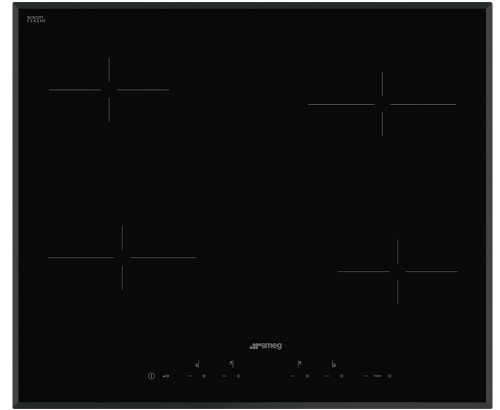

Aesthetics



Aesthetic	Universale
Colour	Black
Finishing	Glass
Material	Glass
Glass type	Ceramic
Glass edge	Angled edge
Type of control setting	Touch controls
Control knob position	Front
Serigraphy colour	Grey

Programs / Functions



Total no. of cook zones	4
No. of ceramic cook zones	4
No. of cooking zones with booster	4
Main on/off switch	Yes
Power levels	9

Options



Standard cut out	490x560 mm	Residual time indicator	Yes
------------------	------------	-------------------------	-----

Keep warm automatic function	Yes	Limited Power Consumption Mode	Yes
End cooking timer	4	Limited Power Consumption Mode in W	2800, 4000 W
Minute minder	1	Showroom Demo Option	Yes
End of cooking alarm	Yes	Control Lock / Child Safety	Yes

Technical Features



Front-left - Ceramic - Single - 1.80 kW - Ø 18.4 cm
 Rear-left - Ceramic - Single - 1.20 kW - Ø 14.8 cm
 Rear-right - Ceramic - Single - 1.80 kW - Ø 18.4 cm
 Front-right - Ceramic - Single - 1.20 kW - Ø 14.8 cm

Automatic switch off when overheat	Yes	Residual heat indicator	Yes
Automatic switch off when overflow	Yes		

Electrical Connection

Electrical connection rating (W)	6000 W	Type of electric cable supplied	Yes, Three and Single/Two-phase
Current	26 A	Frequency (Hz)	50/60 Hz
Voltage (V)	220-240 V	Power supply cable length	150 cm
Voltage 2 (V)	380-415 V	Terminal box	6 poles
Type of electric cable	Double universal		

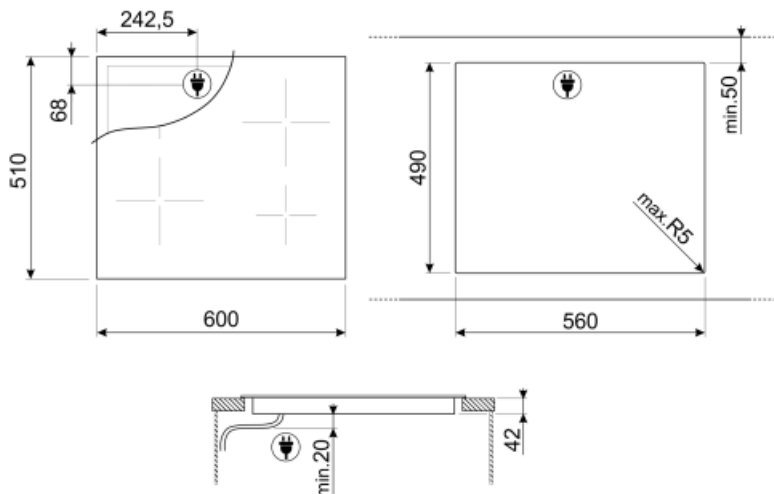













Not included accessories



SCRP

Induction and ceramic hobs and teppanyaki scraper

Symbols glossary (TT)

	Power booster: option allows the zone to work at full power when very intense cooking is necessary.		Ultra-low profile: Installation of product with flat edge - height of 1 mm.
	Child lock: some models are fitted with a device to lock the programme/cycle so it cannot be accidentally changed.		ECO-logic: option allows you to restrict the power limit of the appliance real energy saving.
	Keep warm function: Keep warm function keeps the cooked food heated. In this mode the heating zone operates at a minimum capacity for 120 minutes and then turns off automatically.		Overheat protection: The safety system that automatically turns off the hob in case of overheating of the control unit.
	Glass ceramic: The base of the hob is made glass ceramic. Heating is performed by the heating elements Hi-Light.		Overfill protection: The special overfill protection shuts down the stove in the presence of overflow of liquids.
	Indication of residual heat: After the glass ceramic hob is switched off the residual heat indicator shows which of the heating zones still remains hot. When the temperature drops below 60 ° C, the indicator goes out.		Time elapsed: shows how long the cooking zone has been in use.
	Timer: All ceramic hobs have a timer which automatically ends cooking after a preset time.		Touch control