

PX364LAU

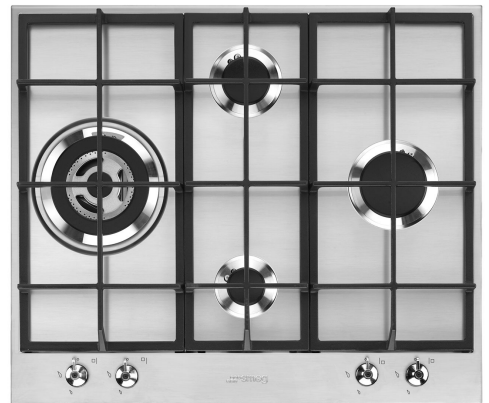

Product Family	Hob
Built-in type	Traditional
Dimensions	60 cm
Power supply	Gas
Type	Gas
EAN code	8017709261290



Aesthetics



Aesthetic	Classic
Colour	Stainless steel
Finishing	Satin
Material	Stainless Steel
Type of steel	Brushed
Serie	New
Pan stands	Cast iron
Burners	Smeg Contemporary
Burners Material	Alluminium
Type of control setting	Control knobs
Control knob position	Front
No. of controls	4
Controls colour	Steel effect
Serigraphy colour	Black

Programs / Functions

Total no. of cook zones	4
No. of gas cook zones	4

Options



Standard cut out	478-482x555-560 mm
-------------------------	--------------------

Technical Features

UR

Left - Gas - UR - 3.50 kW

Rear-centre - Gas - Semi Rapid - 1.80 kW

Front-centre - Gas - AUX - 1.10 kW

Right - Gas - Rapid - 2.60 kW

Gas safety valves Yes Automatic Ignition Yes

Electrical Connection

Plug	(I) Australia	Frequency (Hz)	50/60 Hz
Electrical connection rating (W)	1 W	Power supply cable length	120 cm
Voltage (V)	220-240 V	Plug	I
Type of electric cable	Single phase		

Gas Connection

Gas Type	G20 Natural gas	Other gas nozzles included	G30 GPL Liquid gas
Gas connection	Conical	Gas connection rating (W)	9583.33 W

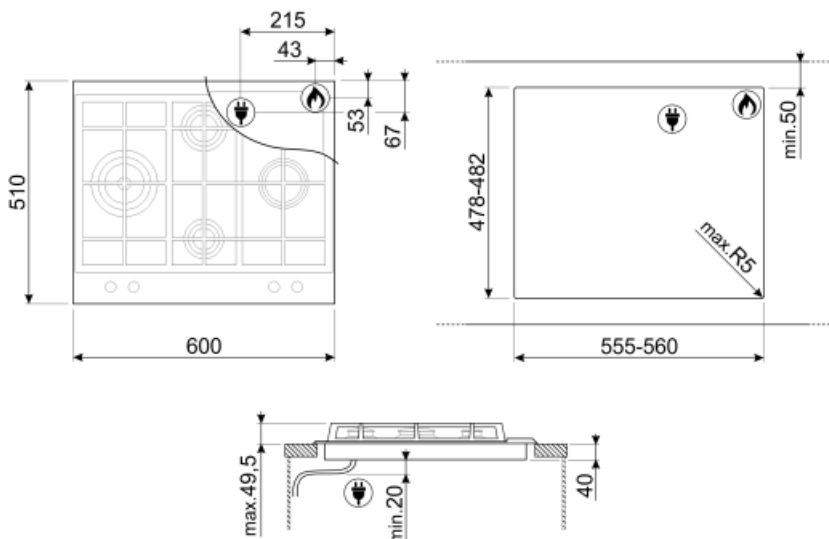

Not included accessories

6MP1PX3

Hob knobs set - Linea



WOKGHU

Cast-Iron WOK Support



GRW





Wok support



TPK

Stainless steel grill plate to cook
Teppanyaki dishes

Symbols glossary (TT)

- | | | | |
|--|--|---|--|
|  | Standard installation: Traditional installation in tabletop, suitable for any kitchen sets |  | Heavy duty cast iron pan stands: for maximum stability and strength. |
|  | Knobs control |  | CUT_OUT_STANDARD_72dpi |
|  | Ultra rapid burners: Powerful ultra rapid burners offer up to 5kw of power. | | |