

1. INSTRUCTIONS FOR USE	34
2. SAFETY PRECAUTIONS	36
3. ENVIRONMENTAL RESPONSIBILITY.....	38
4. KNOW YOUR APPLIANCE	39
5. USING THE HOB.....	40
6. CLEANING AND MAINTENANCE	56
7. POSITIONING ON THE HOB TOP.....	59

THESE INSTRUCTIONS ARE VALID FOR THOSE COUNTRIES IDENTIFIED BY THE SYMBOLS REPORTED ON THE COVER OF THIS MANUAL.



INSTRUCTIONS FOR THE USER: these instructions contain user recommendations, a description of the controls and the correct procedures for cleaning and maintenance of the appliance.



INSTRUCTIONS FOR THE INSTALLER: these are intended for the qualified technician who must install the appliance, set it functioning and carry out an inspection test.



Further information about the products can be found at www.smeg.com



1. INSTRUCTIONS FOR USE



THIS MANUAL CONSTITUTES AN INTEGRAL PART OF THE APPLIANCE. THIS MANUAL CONSTITUTES AN INTEGRAL PART OF THE APPLIANCE. IT SHOULD BE KEPT INTACT AND AT HAND FOR THE APPLIANCE'S ENTIRE LIFE CYCLE.

IT IS IMPORTANT TO CAREFULLY READ THIS MANUAL AND ALL THE INSTRUCTIONS CONTAINED HEREIN BEFORE USING THE APPLIANCE. INSTALLATION MUST BE CARRIED OUT BY COMPETENT PERSONS IN ACCORDANCE WITH THE REGULATIONS IN FORCE. THIS APPLIANCE IS INTENDED FOR HOUSEHOLD USE AND COMPLIES WITH THE EEC DIRECTIVES CURRENTLY IN FORCE. THE APPLIANCE HAS BEEN BUILT TO CARRY OUT THE FOLLOWING FUNCTIONS: COOKING FOOD; IT IS CONSIDERED UNSUITABLE FOR ANY OTHER USE.

THE MANUFACTURER CANNOT BE HELD LIABLE FOR USE OTHER THAN AS INDICATED.



IF THE APPLIANCE IS INSTALLED ON BOATS OR IN CARAVANS, DO NOT USE IT AS A ROOM HEATER.



DO NOT USE THIS APPLIANCE FOR HEATING ROOMS.



THIS APPLIANCE IS MARKED ACCORDING TO EUROPEAN DIRECTIVE 2002/96/EC ON WASTE ELECTRICAL AND ELECTRONIC EQUIPMENT (WEEE).

THIS DIRECTIVE DEFINES THE STANDARDS FOR THE COLLECTION AND RECYCLING OF WASTE ELECTRICAL AND ELECTRONIC EQUIPMENT APPLICABLE THROUGHOUT THE EUROPEAN UNION.



THE IDENTIFICATION PLATE WITH THE TECHNICAL DATA, SERIAL NUMBER AND BRAND NAME HAS BEEN VISIBLY AFFIXED TO THE APPLIANCE.

DO NOT REMOVE THIS PLATE FOR ANY REASON.



BEFORE OPERATING THE APPLIANCE ALL PROTECTIVE COVERS MUST BE REMOVED.



SUITABLE HEAT-PROOF GLOVES SHOULD BE WORN FOR ALL OPERATIONS.



DO NOT USE STEEL SPONGES AND SHARP SCRAPERS AS THEY WILL DAMAGE THE SURFACE.

USE NORMAL NON-ABRASIVE PRODUCTS, INCLUDING WOODEN OR PLASTIC UTENSILS IF NECESSARY. RINSE THOROUGHLY AND DRY USING A SOFT CLOTH OR A MICROFIBRE CLOTH.





General instructions

GB-IE



DO NOT LEAVE THE APPLIANCE UNATTENDED DURING COOKING PROCESSES WHERE FATS OR OILS COULD BE RELEASED. FATS AND OILS MAY CATCH FIRE.



ALWAYS CHECK THAT THE CONTROL KNOBS ARE IN THE  (OFF) POSITION WHEN YOU FINISH USING THE APPLIANCE



NEVER PLACE PANS WITH BOTTOMS WHICH ARE NOT PERFECTLY FLAT AND SMOOTH ON THE COOKING HOB PAN STANDS.



NEVER USE PANS WHICH PROJECT BEYOND THE OUTSIDE EDGE OF THE HOB.



DO NOT OBSTRUCT VENTILATION OPENINGS AND HEAT DISPERSAL SLITS.



(ONLY FOR GLASS CERAMIC MODELS)

TAKE CARE NOT TO SPILL SUGAR OR SWEET MIXTURES ONTO THE HOB WHEN HOT. NEVER PLACE MATERIALS OR SUBSTANCES WHICH MAY MELT (PLASTIC OR ALUMINIUM FOIL) ON THE HOB. IF THIS OCCURS, PROMPTLY SWITCH OFF THE COOKING ZONES AND CLEAN WHILE THE HOT PLATE IS STILL LUKEWARM TO PREVENT DAMAGE TO THE SURFACE. **IF THE GLASS CERAMIC HOB IS NOT CLEANED IMMEDIATELY, THERE IS A RISK THAT INCRUSTATIONS WILL BE LEFT THAT ARE IMPOSSIBLE TO REMOVE ONCE THE HOB HAS COOLED.**



2. SAFETY PRECAUTIONS



REFER TO THE INSTALLATION INSTRUCTIONS FOR THE SAFETY REGULATIONS FOR ELECTRIC OR GAS APPLIANCES AND VENTILATION FUNCTIONS.

IN YOUR INTERESTS AND FOR YOUR SAFETY THE LAW REQUIRES THAT THE INSTALLATION AND SERVICING OF ALL ELECTRICAL APPLIANCES IS CARRIED OUT BY QUALIFIED PERSONNEL IN ACCORDANCE WITH THE REGULATIONS IN FORCE.

OUR APPROVED INSTALLERS GUARANTEE A SATISFACTORY JOB.

GAS OR ELECTRICAL APPLIANCES MUST ALWAYS BE DISCONNECTED BY SUITABLY SKILLED PEOPLE.



BEFORE CONNECTING THE APPLIANCE TO THE POWER GRID, CHECK THE DATA ON THE PLATE AGAINST THE DATA FOR THE GRID ITSELF.



THE IDENTIFICATION PLATE CONTAINING THE TECHNICAL DATA, SERIAL NUMBER AND

BRAND NAME IS IN A VISIBLE POSITION UNDER THE CASING.

DO NOT REMOVE THIS PLATE ON THE CASING FOR ANY REASON.



BEFORE CARRYING OUT INSTALLATION/MAINTENANCE WORK, MAKE SURE THAT THE APPLIANCE IS NOT CONNECTED TO THE POWER GRID.



THE PLUG TO BE CONNECTED TO THE POWER SUPPLY CABLE AND ITS SOCKET MUST BE OF THE SAME TYPE AND CONFORM TO THE REGULATIONS IN FORCE.

THE SOCKET MUST BE ACCESSIBLE AFTER THE APPLIANCE HAS BEEN BUILT IN.

NEVER DISCONNECT THE PLUG BY PULLING ON THE CABLE.



IF THE POWER SUPPLY CABLE IS DAMAGED, CONTACT THE TECHNICAL SUPPORT SERVICE IMMEDIATELY AND THEY WILL REPLACE IT.



IT IS OBLIGATORY FOR ALL ELECTRICAL EQUIPMENT TO BE EARTHED ACCORDING TO THE METHODS LAID DOWN BY SAFETY REGULATIONS.



IMMEDIATELY AFTER INSTALLATION, CARRY OUT A BRIEF INSPECTION TEST, FOLLOWING THE INSTRUCTIONS BELOW. SHOULD THE APPLIANCE NOT FUNCTION, DISCONNECT IT FROM THE ELECTRICITY SUPPLY AND CALL THE NEAREST TECHNICAL SUPPORT CENTRE.

NEVER ATTEMPT TO REPAIR THE APPLIANCE.



DURING USE THE APPLIANCE BECOMES VERY HOT. BE CAREFUL NOT TO TOUCH THE HEATING ELEMENTS.



THIS APPLIANCE MAY NOT BE USED BY PEOPLE (INCLUDING CHILDREN) OF REDUCED PHYSICAL AND MENTAL CAPACITY, OR LACKING IN EXPERIENCE IN THE USE OF ELECTRICAL APPLIANCES, UNLESS THEY ARE SUPERVISED OR INSTRUCTED BY ADULTS RESPONSIBLE FOR THEIR SAFETY.



General instructions

GB-IE



DO NOT LET CHILDREN GO NEAR THE APPLIANCE WHEN IT IS IN OPERATION OR PLAY WITH IT AT ANY TIME.



DO NOT INSERT POINTED METAL OBJECTS (CUTLERY OR UTENSILS) INTO THE SLITS IN THE APPLIANCE.



DO NOT USE STEAM JETS FOR CLEANING THE APPLIANCE. THE STEAM COULD REACH THE ELECTRONICS, DAMAGING THEM AND CAUSING SHORT-CIRCUITS.



DO NOT MODIFY THIS APPLIANCE.



FAT AND OIL CAN CATCH FIRE IF THEY OVERHEAT. YOU ARE THEREFORE RECOMMENDED NOT TO LEAVE THE HOB WHILE PREPARING FOODS CONTAINING OIL OR FAT. IF FAT OR OIL CATCHES FIRE, NEVER PUT WATER ON IT. COVER THE PAN AND SWITCH OFF THE COOKING ZONE.



AS SOON AS YOU NOTICE A FRACTURE OR A CRACK ON THE SURFACE OF THE GLASS CERAMIC HOB, SWITCH THE APPLIANCE OFF AND CONTACT AN AUTHORISED TECHNICAL ASSISTANCE CENTRE.



DO NOT SPRAY ANY SPRAY PRODUCTS NEAR THE ELECTRICAL APPLIANCE WHILE IT IS IN OPERATION. DO NOT USE SPRAY PRODUCTS WHILE THE PRODUCT IS STILL HOT.



USERS OF PACEMAKERS OR SIMILAR DEVICES MUST ENSURE THAT THE OPERATION OF THEIR DEVICES WILL NOT BE AFFECTED BY THE INDUCTION FIELD, WHICH HAS A FREQUENCY RANGE OF 20-50 KHZ.



IN CONFORMITY WITH THE PROVISIONS REGARDING ELECTROMAGNETIC COMPATIBILITY, THE ELECTROMAGNETIC INDUCTION COOKING HOB COMES UNDER GROUP 2 AND CLASS B.



The manufacturer cannot be held liable for damage to persons or things caused by failure to observe the above instructions, by interference with any part of the appliance or by the use of non-original spare parts.



3. ENVIRONMENTAL RESPONSIBILITY

3.1 Our environmental responsibility



Pursuant to Directives 2002/95/EC, 2002/96/EC and 2003/108/EC relating to the reduction of the use of hazardous substances in electrical and electronic appliances, as well as to the disposal of refuse, the crossed out bin symbol on the appliance indicates that at the end of the useful life of the product, it must be collected separately from other refuse. Therefore, at the end of the product's working life, the user must deliver it to the appropriate differentiated collection centres for electrical and electronic waste, or deliver it back to the retailer when purchasing an equivalent product, on a one-for-one basis. Adequate differentiated collection for the subsequent forwarding of the decommissioned product to recycling, processing and ecologically compatible disposal contributes to avoiding possible negative effects on the environment and on health, and promotes recycling of the appliance's constituent materials. Illicit disposal of the product by the user will lead to the application of administrative sanctions.

The product does not contain substances in quantities sufficient to be considered hazardous to health and the environment, in accordance with current European directives.

3.2 Your environmental responsibility

Our product's packing is made of non-polluting materials, which are therefore compatible with the environment and recyclable. Please help by disposing of the packaging correctly. You can obtain the addresses of collection, recycling and disposal centres from your retailer or from the competent local organisations.



Do not discard the packaging or any part of it, or leave it unattended. It can constitute a suffocation hazard for children, especially the plastic bags.

Your old appliance also needs to be disposed of correctly.

Important: hand over your appliance to the local agency authorised for the collection of electrical appliances no longer in use. Correct disposal enables intelligent recovery of valuable materials.

Before disposing of your appliance it is important to remove doors and leave shelves in the same position as for use, to ensure that children cannot accidentally become trapped inside during play. It is also necessary to cut the connecting cable to the power grid, removing it along with the plug.



4. KNOW YOUR APPLIANCE

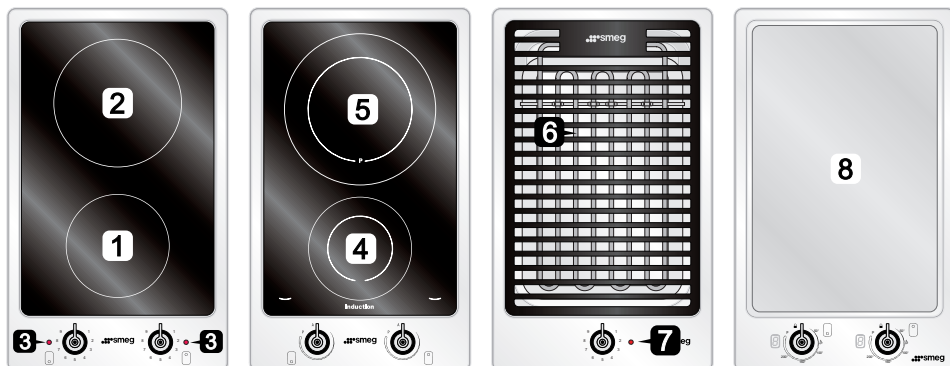

- | | | | |
|----------|--------------------------------|----------|--------------------------------------|
| 1 | Small glass ceramic hot plate | 5 | Large induction hot plate |
| 2 | Large glass ceramic hot plate | 6 | Barbecue resistance |
| 3 | Residual heat indicator lights | 7 | Barbecue resistance thermostat light |
| 4 | Small induction hot plate | 8 | Teppan yaki plate |



Before using the electric plates or the barbecue (if included) for the first time, pre-heat them to the maximum temperature long enough to burn off any manufacturing oily residues which could give the food a bad smell.



5. USING THE HOB

5.1 Glass ceramic hob

The appliance has two cooking zones of various power levels and diameters.

The positions are clearly indicated by circles and the heat is concentrated within the diameters traced on the hob. The radiating zones come on after a few seconds and their heat level can be adjusted by rotating the knob of the power regulator.



To switch the cooking zones on, rotate the knob to the desired position between **1** and **9**.

The adjustment is gradual so all the intermediate zones can be used. The lights to the side of the knobs indicate the residual heat: they come on when the electric hot plates exceed 50°C and go off when the temperature falls below this level. For cleaning, see paragraph "6.2 Cleaning the cooking hob parts".

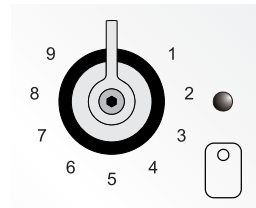



5.1.1 Cooking guidelines

The table below shows the power values which can be set, with the relative type of food alongside. Settings may vary depending on the amount of food and personal taste.

Knob Position	Suitable kind of cooking
1	To melt butter, chocolate or similar products.
2 - 3	To heat food, keep small amounts of water on the boil, and whip up sauces with egg yolk or butter.
4 - 5	To heat solid or liquid food, keep water on the boil, thaw deep-frozen food, cook omelettes of 2 or 3 eggs, fruit and vegetables, various cooking processes.
6	To stew meat, fish and vegetables, simmer food, make jams, etc.
7 - 8	To roast meat, fish, steaks and liver; to sauté meat, fish, eggs, etc.
9	To deep-fry potatoes, etc., or bring water to the boil rapidly.

For best cooking results and energy saving, only use containers suitable for electric cooking:

- The bases of containers must be very thick, perfectly flat and clean and dry. The hob must also be clean and dry.
- Do not use cast iron saucepans or saucepans with a rough base, as they may scratch the cooking surface.

The diameter of the base of the saucepans must be equal to the diameter of the circle outlining the cooking zone. If not, energy will be wasted.



5.2 Induction hob



Metal objects such as silverware or lids must not be placed on the cooking hob surface as they can become very hot.

5.2.1 Cooking zones

The appliance has two cooking zones of various power levels and diameters. Their position is clearly indicated with circles and the heat is limited to within the diameters traced on the glass.

Under each cooking zone there is a coil called an inductor which is powered by an electronic system and which creates a variable magnetic field. When a pan is positioned within this magnetic field, the high frequency currents are concentrated directly onto the pan producing the heat required for cooking the food.



The symbols alongside the knobs indicates the cooking zone they control. To switch a zone on, press the knob and turn it to the desired position. Adjustment is continuous, so the appliance functions when set to the intermediate values as well. To switch off a zone, reset the knob to **0**.

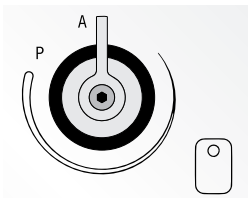

The two displays next to the cooking zones indicate the cooking power and special “Booster” and “Automatic heating” functions.





5.2.2 Booster function

The induction hob has a booster function for reaching the required temperature quickly. This is especially useful for pans containing water. The booster generates a temporary power output higher than the nominal power of the cooking zone itself.

The booster is activated by rotating the knob clockwise to position **P**. The **P** symbol on the display for the selected zone lights up to indicate that the booster function is active.

The booster remains active for a maximum of 10 minutes, after which it switches itself off. The display indicates the maximum cooking power [9]. The symbol **P** will flash for 3 seconds prior to the booster function switching off.

The booster function will also automatically switch off when the temperature of the hob exceeds the set point of the built-in power controller.

If the knob is returned to position **P** while the booster function is still active, the maximum power value [9] will appear on the display.

The function can also be switched off by rotating the knob anticlockwise to a lower power level.



5.2.3 Automatic heating control

The automatic heating control is used to provide maximum power to a cooking zone for the period of time applicable to the selected power. At the end of this time period, the automatic control will switch off and the previously selected power will appear on the display.

To activate this function, rotate the knob anticlockwise to position **A**. The symbol **A** will appear on the display. Select the required cooking power within the next 10 seconds. After this time, the automatic heating control will switch in and the symbol **A** will be displayed until the function switches off.

When the automatic heating control switches off, the display will indicate the previously selected power value.

The automatic heating control can be switched off by rotating the knob to a higher or lower power, or by activating the booster function.



5.2.4 Operating power settings

Below is provided a table with the maximum power consumptions of the hotplates.

Zone Number	Zone Diameter	Power consumed	
		Normal operation:	1850 W
1	210 mm.	With booster function	2500 W
		Normal operation:	1400 W
2	140 mm.	With booster function	1800 W



Before using the hob for the first time, pre-heat it to the maximum temperature long enough to burn any manufacturing oily residues which could give the food unpleasant odours.

5.3 Cookware

Appliances of this type require special cookware to be able to work.

In fact, the cookware must have an iron or steel/iron bottom to generate the magnetic field necessary for it to be heated up.

Recipients made of the following are not suitable:

- glass
- ceramic:
- terracotta
- steel, aluminium or copper without a magnetic bottom

To see whether the pan is suitable, bring a magnet close to the bottom: if it is attracted, the pan is suitable for induction cooking. If you do not have a magnet, you can put a small amount of water in the recipient, place it on a cooking zone

and start the hotplate. If, instead of the power symbol, the  symbol appears, it means the pan is not suitable or is not positioned correctly.

The pans used for cooking must have a minimum diameter to guarantee proper functioning.

Below is a table with the minimum diameters for pans according to the cooking zone.



COOKING ZONE OF THE HOB

Ø min. (in cm)

- | | | |
|---|----------------------|----|
| 4 | Small induction zone | 9 |
| 5 | Large induction zone | 14 |

Pans that are larger than the cooking zones can also be used, but care must be taken that the bottom of the pan does not come into contact with other cooking zones and that it is always centred on the cooking zone perimeter.



Make sure you only use containers intended for induction cooking, with a **thick and completely flat bottom** or, if not available, containers **without a curved bottom** (concave or convex).

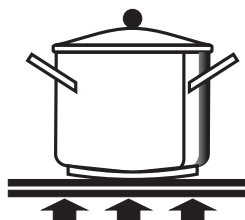
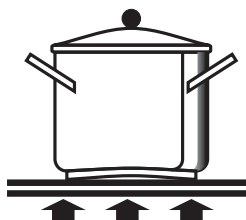
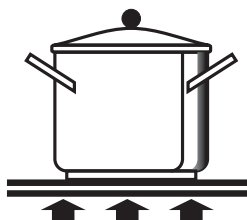





5.3.1 Pan detection

Every cooking zone has a cookware detector that only starts the cooking if there is a well positioned container with the suitable characteristics present on the hotplate.

If the container is not well positioned or is not made of the correct material and still tries to activate the hotplate, after a few seconds from the hotplatesactivation, the  symbol will appear on the display.



5.3.2 Residual heat

Each cooking zone is equipped with a residual heat warning device. After any zone is switched off, a flashing  may appear on the display. This warns that the cooking zone concerned is still very hot. Cooking can be restarted while the  is flashing.



5.3.3 Cooking hob control lock-out

When not in use, the hob controls can be locked from being accidentally turned on by children.

With the hotplates switched off turn both knobs to symbol **A** and hold them there for approximately 2 seconds until the  symbols appear on the power display. Then release the knobs.

The function can be activated by rotating just one knob to symbol **A** and holding it there for at least 5 seconds.

To unlock it repeat the same operation: The hotplates displays will show a 0 that will indicate that the hotplates lock has been deactivated.

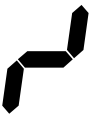

5.3.4 Error message

The functions of all the controls are monitored. If an error situation occurs for one of the knobs, the unaffected zones will continue their normal operation. The cooking zone affected by the error will switch off automatically and the symbol  will appear on the display.



5.3.5 Circuit board thermal protection

The appliance is provided with a device that constantly measures the temperature of the electronic circuit board.

If the temperature surpasses certain values, the device will activate certain functions to lower the temperature and allow the glass ceramic hob to continue to work correctly.

Below is a table with the operations that are activated automatically and the relative start temperature:

Operation	Activating temperature
Fan turns on at low speed	50° C
Fan turns on at high speed	60° C
Fan returns to low speed	55° C
Fan turns off	45° C
Operating power reduced from booster to 9	76° C
Reduction of power of a point for every cooking zone	85° C
Turning off all the cooking zones	90° C
Switching the cooking zones on again at reduced power	85° C
Normal operation of all the cooking zones	80° C

Every intervention of this type will be identified on the cooking hob with a flashing light on the power display.

5.3.6 Glass ceramic hob thermal protection

Every cooking zone has a device that constantly measures the temperature.

If the temperature surpasses certain values, the device will activate certain functions to lower the temperature and allow the glass ceramic hob to continue to work correctly.

Below is a table with the operations that are activated automatically and the relative start temperature:



Operation	Activating temperature
Operating power reduced from Power to 9	250° C
Reduction of the power of a point	280° C
Switching off the cooking zone	300° C
Return of the power to the set value	250° C

Every intervention of this type will be identified on the cooking hob with a flashing light on the power display.



5.3.7 Warming function

The purpose of the keep warm function is to regulate the temperature of the bottom of the cookware to approximately 70 . This allows for keeping food warm at the ideal power level, as well as heating slowly. The maximum duration of the keep warm function is limited to 2 hours.

The keep warm function is between [0] and [1] and is indicated by the symbol  on the cooking zones.

5.4 Barbeque hob

The adjustment of the barbeque hot plates power is done using the control knob, turning it to the desired position between '1 and 9.

The adjustment is gradual so all the intermediate zones can be used.

The indicator light comes on to indicate that the plate is heating up. When this light goes out, the preset power level has been reached.

When the light flashes regularly it means that the power of the hot plate is kept steady on the set level. To remove the rack for cleaning, see paragraph "6.3 Cleaning the barbeque"

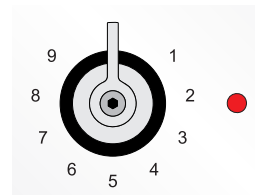
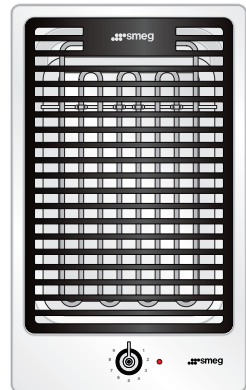



You can use the rack for **grilling**, **cooking au gratin** or as a **barbeque**.

In the tray under the resistance you can put:

- water to catch the fat and any grease dripping from the cooking (do not put more than a litre and a half of water into the tray),
- a layer of lava rock that keeps in the heat for longer and therefore improves the cooking times and quality.

In both cases, do not exceed the edge of the tray.

Before pouring the water into the tray or putting in the lava rock, block the resistance as show in the figure.

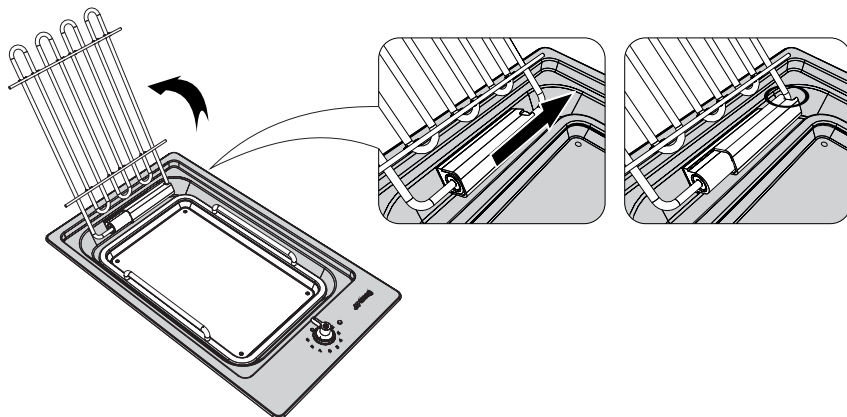

WARNING!

- if the tilted resistance is raised, it must always be blocked with the proper sliding device.
- Before lifting the resistance up, make sure it is cool. Danger of burns!
- When the resistance is raised, take care not to activate the control device. Danger of burns!



5.5 Teppan yaki hob

This hob enables food to be cooked or heated directly on the plate, with or without oil. This kind of cooking uses temperatures that never exceed the smoke points of the food (i.e. the temperatures at which food starts to burn) and very rapid cooking times.

The appliance has two cooking zones of equal power levels and diameters. They are positioned roughly at the front half and the rear half of the plate.

Under each cooking zone there is a coil called inductor which is powered by an electronic system and which creates a variable magnetic field. When the teppan yaki plate is positioned within this magnetic field, the high frequency currents are concentrated directly onto the plate producing the heat required for heating and cooking the food.



The symbol adjacent to the knobs indicates the cooking zone they control. To switch a zone on, turn the knob to the desired position. Adjustment is continuous, so the appliance functions when set to the intermediate values as well. To switch off a zone, reset the knob to **0**.

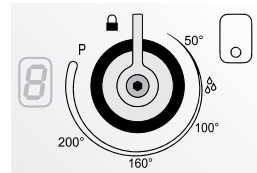

5.6 Display

The two displays at the side of the knobs provide information on the power levels, heating and cooling of the plate, as well as the special "Booster" function. The displays show the temperature levels, from **1** to **9**. Correspondence between the temperature level and the nominal value is indicated in the values table in paragraph "5.8 Operating temperatures".

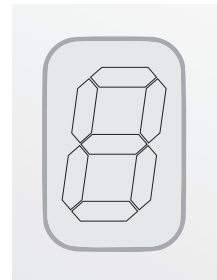



5.6.1 Heating

Setting the knob to a higher value than the original value starts the heating phase. While a cooking zone is heating the display alternates between the adjacent symbols and darkness (roughly every second).

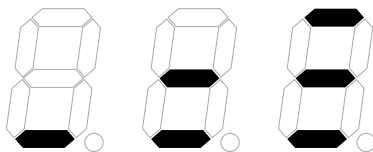

5.6.2 Cooling

Regolando la manopola ad un valore minore di quello di partenza si avvierà la fase di raffreddamento. Durante il raffreddamento di una zona cottura sul display verranno visualizzati in modo alternato (ogni secondo circa) i simboli a fianco, compresa una fase di oscuramento.

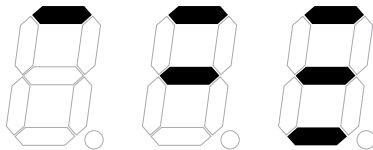

5.6.3 Reaching the temperature

When the cooking zone reaches the set temperature, the adjacent symbol is displayed continuously for about 5 seconds.

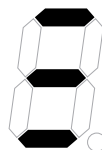

5.6.4 Alternation of symbol display

While the temperature level is being adjusted, and for about 5 seconds after the last adjustment, the display shows the selected level (from **1** to **9**). Then, depending on whether the plate is to heat or cool, the sequences of zone heating or cooling symbols are displayed. Once the temperature is reached, the symbol , appears for about 5 seconds, after which the temperature level is displayed.



5.6.5 Booster function

The induction hob has a booster function for rapidly reaching temperatures. This is recommended for saucepans and frying pans containing water. This booster temporarily boosts the power thus exceeding also the nominal output of the zone.

The booster is activated by turning the knob clockwise to position **P**. The symbol

 appears on the relevant cooking zone display when the booster is on.

The booster remains active for up to 10 minutes and then switches off. The display indicates the maximum cooking value [9]. During the last 3 seconds of the booster function, the symbol  flashes to indicate it is about to switch off.



The booster function will also switch off automatically if the hob becomes excessively hot or the integrated power control is triggered.

If the knob is again turned to position **P** while the booster is already on, the display indicates the maximum power value [9].

The function can be switched off by turning the knob anticlockwise to a lower power level.



5.6.6 Residual heat

Each cooking zone is equipped with a residual heat warning device. After any zone is switched off, a flashing  may appear on the display. This warns that the cooking zone concerned is still very hot. Cooking may be resumed while  is flashing.



5.6.7 Hob controls lock-out

When not in use, the hob controls can be locked to prevent children turning them on by accident.



With the hotplates switched off, turn and hold both knobs to symbol  for

about 2 seconds until the power symbol  appears on the displays. Then release the knobs.

The function can also be activated by turning and holding one knob to symbol

 for at least 5 seconds.

To unlock it repeat the same operation: the hotplate's displays will show a **0** that will indicate that the hotplate's lock has been deactivated.



5.7 Using fat and oil

When using fat and oil in cooking, it is very important to cook at the right temperatures. Fat and oil will keep their properties intact when used at the correct temperature. If the temperature is too high, fat and oil begin to smoke (smoke point) and then burn.

Fat - oil	Maximum temperature (°C)	Smoke point (°C)
Butter	130	150
Lard	170	200
Beef fat	180	210
Olive oil	180	200
Sunflower oil	200	220
Peanut oil	200	235

5.8 Operating temperatures

The table below indicates the temperatures corresponding to each plate heating level

Position	Temperature (°C)
0	-
1	50
2	80
3	100
4	130
5	160
6	180
7	200
8	220
9	230



The temperatures are indicative; the real value may differ from that indicated by $\pm 10^\circ$.



The data given in the table are indicative and apply to a pre-heated appliance. The values may vary depending on the type and quantity of food. Place the food on the plate solely once it has finished pre-heating.



5.8.1 Teppan yaki thermal protection

Every cooking zone has a device that constantly measures the temperature. If the temperature surpasses certain values, the device will activate certain functions to lower the temperature and allow the teppan yaki plate to continue to work correctly. Below is a table with the operations that are activated automatically and the relative start temperature:

Operation	Activating temperature
Operating power reduced from Power to 9	250° C
Reduction of the power by one point	280° C
Switching off the cooking zone	300° C
Return of the power to the set value	250° C

Every intervention of this type will be identified on the cooking hob with a flashing light on the power displays.

5.8.2 Circuit board thermal protection

The appliance is equipped with a device that constantly measures the temperature of the electronic circuit board. If the temperature surpasses certain values, the device will activate certain functions to lower the temperature and allow the teppan yaki plate to continue to work correctly. Below is a table with the operations that are activated automatically and the relative start temperature:

Operation	Activating temperature
Fan turns on at low speed	50° C
Fan turns on at high speed	60° C
Fan returns to low speed	55° C
Fan turns off	45° C
Operating power reduced from booster to 9	76° C
Reduction of power by one point for every cooking zone	85° C
Turning off all the cooking zones	90° C
Switching the cooking zones on again at reduced power	85° C
Normal operation of all the cooking zones	80° C

Every intervention of this type will be identified on the cooking hob with a flashing light on the power displays.



5.9 Precautions when using the teppan yaki plate



The hob is not designed for cooking foodstuffs in pans or other cookware.



Despite the steel cooking surface being very tough and smooth, traces of wear may appear over time and with normal use. This will not however affect the performance of the plate. Slight yellowing of the steel surface is entirely normal.



Do not use knives to cut food on the cooking surface to avoid scratching it. Do not use sharp cutlery to turn the food. These precautions help prevent scratches or dents appearing on the teppan yaki plate.



6. CLEANING AND MAINTENANCE



Before performing any operations requiring access to powered parts, switch off the power supply to the appliance



NEVER USE A STEAM JET FOR CLEANING THE APPLIANCE.

6.1 Cleaning stainless steel



To keep stainless steel in good condition it should be cleaned regularly after use. Let it cool first.

6.1.1 Ordinary daily cleaning

To clean and preserve the stainless steel surfaces, use **only** specific products that do not contain abrasives or chlorine-based acids.

How to use: pour the product onto a damp cloth and wipe the surface, rinse thoroughly and dry with a soft cloth or chamois leather.

6.1.2 Food stains or residues

Do not use metallic sponges or sharp scrapers as they will damage the surface.

Use ordinary non-abrasive products for steel, with the aid of wooden or plastic utensils if necessary.

Rinse thoroughly and dry with a soft cloth or chamois leather.



6.2 Cleaning the cooking hob parts



The glass ceramic hob should be regularly cleaned, preferably after every use, once the residual heat warning lights have gone off.

Smudges from aluminium-based pans can be easily cleaned off with a cloth dampened in vinegar. Remove any burnt-on residue after cooking; rinse with water and dry thoroughly with a clean cloth.



Never use a jet of steam to clean the appliance.

6.3 Cleaning the barbeque

Remove the rack from its housing after allowing it to cool down. Clean it using standard washing up liquid and a soft sponge. In order to remove the tray under the barbeque resistance:

- 1 Remove the rack as described.
- 2 Lift the resistance and block it, sliding the hold to the right (as shown in the figure).
- 3 Remove the basin using the two handles and clean using specific cleaning products for stainless steel and a soft sponge.

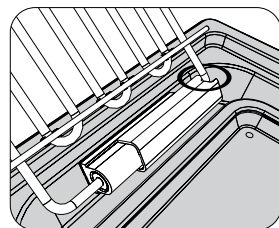
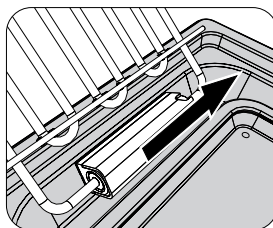
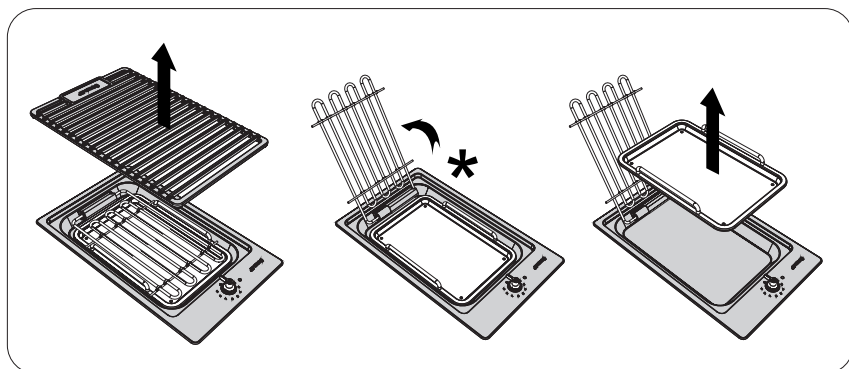

WARNING:

- Before lifting the resistance up, make sure it is cool. Danger of burns!
- When the resistance is raised, take care not to activate the control device. Danger of burns!

6.4 Cleaning the teppan yaki plate



The appliance should be cleaned after every use; otherwise food residue left to dry on the hob can be very difficult to remove.

Do not clean the appliance while it is still hot; wait for it to cool down for at least 15 minutes.

To facilitate cleaning, we recommend using ice cubes with a little washing up detergent. Clean off the residue after leaving it to soften for up to 1 hour.

**WARNING:**

Do not pour water onto the hot appliance, as water vapour and boiling splashes can cause injury.

Whitish stains may occur on the cooking surface, depending on the type of food cooked. These stains can be removed using lemon juice, vinegar or a gentle lime-scale remover. Never use detergents that contain abrasives or chlorine-based acids. Use ordinary non-abrasive products for steel, with the aid of wooden or plastic utensils if necessary.

Then wipe with a damp cloth.

Clean the edge of the appliance using a damp cloth or sponge and washing up detergent.

Dry everything thoroughly once it is clean.



After cleaning manually and before the hob is used again, take care to have **completely** removed any detergent residue.

6.4.1 Assisted cleaning

The teppan yaki plate also has an additional cleaning function. Switch on the appliance by turning both knobs to the assisted cleaning function . Clean the surface using a damp cloth.



7. POSITIONING ON THE HOB TOP



This is a cat. 3 appliance (built-in).

The following operation requires building and/or carpentry work and must therefore be carried out by a competent tradesman.

Installation can be carried out on various materials such as masonry, metal, solid wood or plastic laminated wood as long as they are heat-resistant (T 90°C).

7.1 Built-in dimensions

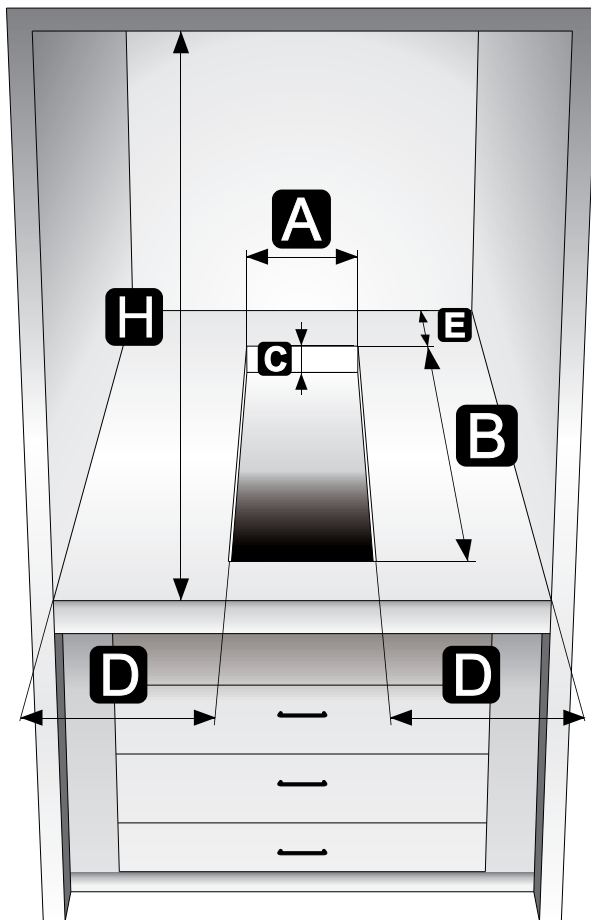

DISTANCES	A	B	C	D	E	H
MINIMUM	292 mm.	494 mm.	20 mm.	110 mm.	50 mm.	750 mm.
MAXIMUM	292 mm.	494 mm.	70 mm.	-	-	-



7.2 Fixing to the supporting structure

Carefully position the supplied insulating seal on the outer edge of the hole on the top hob, as indicated in the figure alongside. Try and make it stick to the whole surface by applying light hand pressure.

The seal must be placed at a distance of 3-4 mm from the edge of the hole in the top.

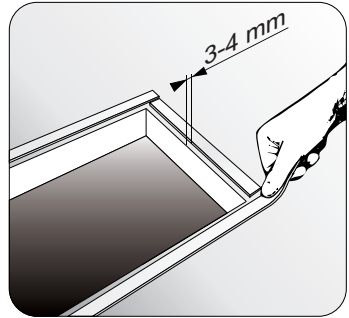

Carry out this operation by supporting the hob on the isolating seal and using screws and clamping brackets to fix the hob to the support structure, in order to obtain the complete flatness.

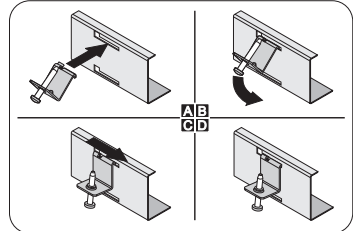

Carefully trim the surplus away from edge beyond the seal.

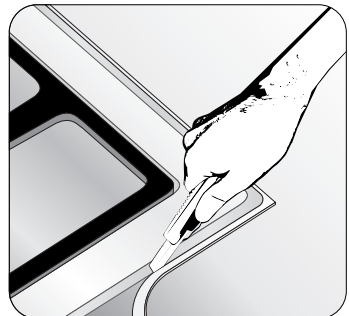



Precautions: the temperature of the inside surface of the hob may exceed 125° C. To avoid any hazardous situations, access to the underside of the hob must be restricted. Refer to the installation instructions.

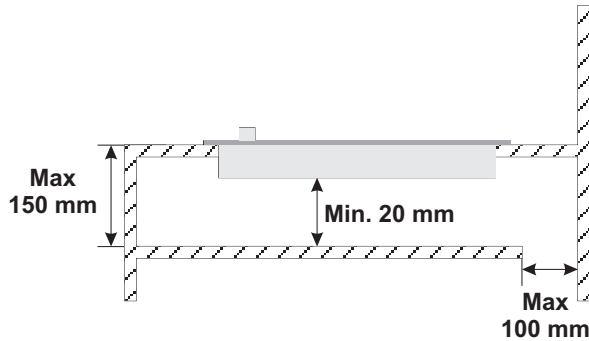

IMPORTANT: if the appliance is mounted on a unit, make sure that a separating shelf is installed, as shown in the figure.

However, if the appliance is on an oven installed under the hob, there is no need to install a separating shelf.

If installed on top of an oven, the latter must be equipped with a cooling fan.



7.3 Electrical connection



Make sure that the voltage and capacity of the power line conform to the data shown on the plate located under the casing. Do not remove this plate for any reason.



The plug at the end of the supply cable and the wall socket must be of the same type and must conform to the applicable legislation on electrical installations. Make sure that the supply line is suitably earthed.



Fit power line with an omnipolar circuit breaker with a contact opening gap equal to or greater than 3 mm in an easily accessible position close to the hob.



Avoid the use of adapters and shunts.



If the power cable is replaced, the cross-section of wires in the new cable must be no less than 1.5 mm² (3 x 0.1.5 cable), remembering that the end for connection to the appliance must have an earth wire (yellow/green) which is

at least 20 mm longer. Only use a H05V2V2-F or similar resistance cable to the maximum temperature of 90°C. Its replacement must be carried out by a specialised technician who must carry out the network connection following the diagram below.

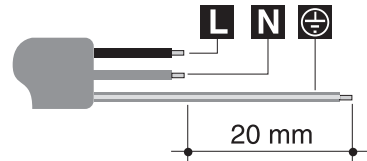

L = brown

N = blue

⊕ = yellow/green



The manufacturer cannot be held liable for damage to persons or things caused by non-observance of the above directions or by interference with any part of the appliance.