

cooking collection

Instructions for use and warranty details

To register your warranty or make a warranty claim, scan this QR code:



Multifunction Oven
Model No.: OMF6040K &
OMF6040X

 **kLEENmaid**

Dear Customer,

Thank you and congratulations for choosing Kleenmaid.

Your new appliance has been designed and meticulously tested to ensure that it meets all your culinary requirements, and has been carefully manufactured using top quality materials to give you years of reliable performance.

For best results, carefully read the instructions on how your new appliance is to be installed. Correct installation will avoid delays and unnecessary service call costs.

Once installation is complete, please read this instruction manual carefully and get to know the controls and the features of your new Kleenmaid appliance. These simple instructions will enable you to achieve excellent results from the very first time you use it.

Again, congratulations and thank you for choosing The Best You Can Own.

KLEENMAID

CONTENTS

4 **SAFETY INFORMATION**

4 Intended use Warning

6 Causes of damage

7 **INSTALLATION**

9 **OPERATING THE APPLIANCE**

9 Control Panel

10 Before using the appliance

11 Functions

12 Using your appliance

12 Manual Cooking

12 Semi-automatic Cooking

13 Automatic Cooking

14 Kitchen Timer

14 Childproof Lock

14 Cooking by ECO Mode

15 Using Sabbath Mode

15 Convection Hot Air Frying

16 **ACCESSORIES**

18 **ENERGY EFFICIENT USE**

18 **MAINTAINING THIS APPLIANCE**

21 **APPLIANCE DOOR**

25 **TELESCOPIC GUIDES**

27 **REPLACING OVEN LAMP**

28 **TROUBLE SHOOTING GUIDE**

30 **CUSTOMER SERVICE**

31 **COOKING & BAKING - HELPFUL SUGGESTIONS**

33 **OVEN SETTINGS BY RECIPE TYPE**

33 Cakes

34 Bread & pizza

35 Meat

36 **SPECIFICATIONS**

36 **ENVIRONMENT**

37 **KLEENMAID WARRANTY**

SAFETY INFORMATION

Intended Use

Before unpacking this appliance, please read the User Manual carefully. Only then will you be able to operate your appliance safely and correctly. We recommend you retain the user manual and installation instructions for future use or for subsequent owners. The latest version of this manual is available on our website. (See back cover for details.)

NOTE: There are oven specific accessories supplied with this oven which should be retained for installation and not discarded when unpacking the oven.

- The appliance is only intended to be fitted in a kitchen.
- Check the appliance for any damage after unpacking it. Do not connect the appliance if it has been damaged.
- Only a licensed professional may connect appliances without plugs. Damage caused by incorrect connection is not covered under warranty.
- Only use this appliance indoors.
- The appliance must only be used for the preparation of food and drink. The appliance must be supervised during operation.
- This appliance is not intended for use by persons (including children) with reduced physical, sensory or mental capabilities, or lack of experience and knowledge, unless they have been given supervision or instruction concerning use of the appliance by a person responsible for their safety.
- Children should be supervised to ensure that they do not play with the appliance.
- Children shall not play with the appliance. Cleaning and user maintenance shall not be made by children without supervision.
- Children shall be kept away unless continuously supervised.
- WARNING : Accessible parts may become hot during use. Young children should be kept away.
- Keep the packaging materials out of the reach of children
- Please always slide accessories into the cavity the right way round.

WARNING

Risk of electric shock!

1. Incorrect repairs are dangerous. Repairs may only be carried out, and damaged power cables replaced, by a trained technicians. If the appliance is defective, unplug the appliance from the mains or switch off the circuit breaker in the fuse box. Contact our Customer Support team for service during the warranty period (see the back cover of this manual for details), or a trained service technician.
2. The cable insulation on electrical appliances may melt when touching hot parts of the appliance. Never bring electrical appliance cables into contact with hot parts of the appliance.
3. Do not use any high-pressure cleaners or steam cleaners, which can result in an electric shock.
4. A defective appliance may cause electric shock. Never switch on a defective appliance. Unplug the appliance from the mains or switch off the circuit breaker in the fuse box. Contact a trained technician.

Risk of burns!

1. The appliance becomes very hot. Never touch the interior surfaces of the appliance or the heating elements.
2. Always allow the appliance to cool down.
3. Keep children at a safe distance.
4. Accessories and oven-ware become very hot. Always use oven gloves to remove accessories or oven-ware from the cavity.
5. Alcoholic vapors may catch fire in the hot cooking compartment. Never prepare food containing large quantities of drinks with high alcohol content. Only use small quantities of drinks with high alcohol content. Open the appliance door with care.

Risk of scalding!

1. The accessible parts become hot during operation. Never touch the hot parts. Keep children at a safe distance.
2. When you open the appliance door, hot steam can escape. Steam may not be visible, depending on its temperature. When opening, do not stand too close to the appliance. Open the appliance door carefully. Keep children away.
3. Water in a hot cavity may create hot steam. Never pour water into the hot cavity.

Risk of injury!

1. Scratched glass in the appliance door may develop into a crack. Do not use a glass scraper, sharp or abrasive cleaning aids or detergents.
2. The hinges on the appliance door move when opening and closing the door, and you may be trapped. Keep your hands away from the hinges.

Risk of fire!

1. Combustible items stored in the cavity may catch fire. Never store combustible items in the cavity. Never open the appliance door if there is smoke inside. Switch off the appliance and unplug it from the mains or switch off the circuit breaker in the fuse box.
2. A draught is created when the appliance door is opened. Greaseproof paper may come into contact with the heating element and catch fire. Do not place greaseproof paper loosely over accessories during preheating. Always weight down the greaseproof paper with a dish or a baking tin. Only cover the surface required with greaseproof paper. Greaseproof paper must not protrude over the accessories.

Hazard due to magnetism!

Permanent magnets are used in the control panel or in the control elements. They may affect electronic implants, e.g. heart pacemakers or insulin pumps. Wearers of electronic implants must stay at least 10 cm away from the control panel.

Causes of Damage

1. Accessories, foil, greaseproof paper or ovenware on the cavity floor: do not place accessories on the cavity floor. Do not cover the cavity floor with any sort of foil or greaseproof paper. Do not place ovenware on the cavity floor if a temperature of over 50 °C has been set. This will cause heat to accumulate. The enamel will be damaged.
2. Aluminum foil: Aluminum foil in the cavity must not come into contact with the door glass. This could cause permanent discoloration of the door glass.
3. Silicone pans: Do not use any silicone pans, or any mats, covers or accessories that contain silicone. The oven sensor may be damaged.
4. Water in a hot cooking compartment: do not pour water into the cavity when it is hot. This will cause steam. The temperature change can cause damage to the enamel.
5. Moisture in the cavity: Over an extended period of time, moisture in the cavity may lead to corrosion. Allow the appliance to dry after use. Do not keep moist food in the closed cavity for extended periods of time. Do not store food in the cavity.
6. Cooling with the appliance door open: Following operation at high temperatures, only allow the appliance to cool down with the door closed. Do not trap anything in the appliance door. Even if the door is only left open a crack, the front of nearby furniture may become damaged over time. Only leave the appliance to dry with the door open if a lot of moisture was produced while the oven was operating.
7. Fruit juice: when baking particularly juicy fruit pies, do not pack the baking tray too generously. Fruit juice dripping from the baking tray leaves stains that cannot be removed. If possible, use the deeper universal pan.
8. Extremely dirty seal: If the seal is very dirty, the appliance door will no longer close properly during operation. The fronts of adjacent units could be damaged. Always keep the seal clean.
9. Appliance door as a seat, shelf or worktop: Do not sit on the appliance door or place or hang anything on it. Do not place any cookware or accessories on the appliance door.
10. Inserting accessories: depending on the appliance model, accessories can scratch the door panel when closing the appliance door. Always insert the accessories into the cavity as far as they will go.
11. Carrying the appliance: do not carry or hold the appliance by the door handle. The door handle cannot support the weight of the appliance and could break.
12. If you use the residual heat of the switched off oven to keep food warm, a high moisture content inside the cavity can occur. This may lead to condensation and can cause corrosion damage of your high quality appliance as well as harm your kitchen. Avoid condensation by opening the door or use "Defrost" mode.
13. The oven and its hinges and associated parts are designed to support the weight of the oven door only, and any damage to the door or its hinges or associated parts which is caused by excessive weight of any kind being placed onto the oven door will not be covered by warranty. The full cost of any warranty service call regarding damage which is assessed to be the result of excessive weight of any kind being placed onto the oven door will be for the care of the owner. Children should specifically be prevented from climbing or standing on the oven door.
14. The appliance should never be lifted or moved by holding the door handle, and it is recommended that the door be removed before lifting or moving the oven.

INSTALLATION

NOTE: Before making preparations for or commencing installation, the installer should refer to the current online version of the User Manual, which is available on the Kleenmaid website (see back cover for details).

Note: Diagram dimensions are in mm.

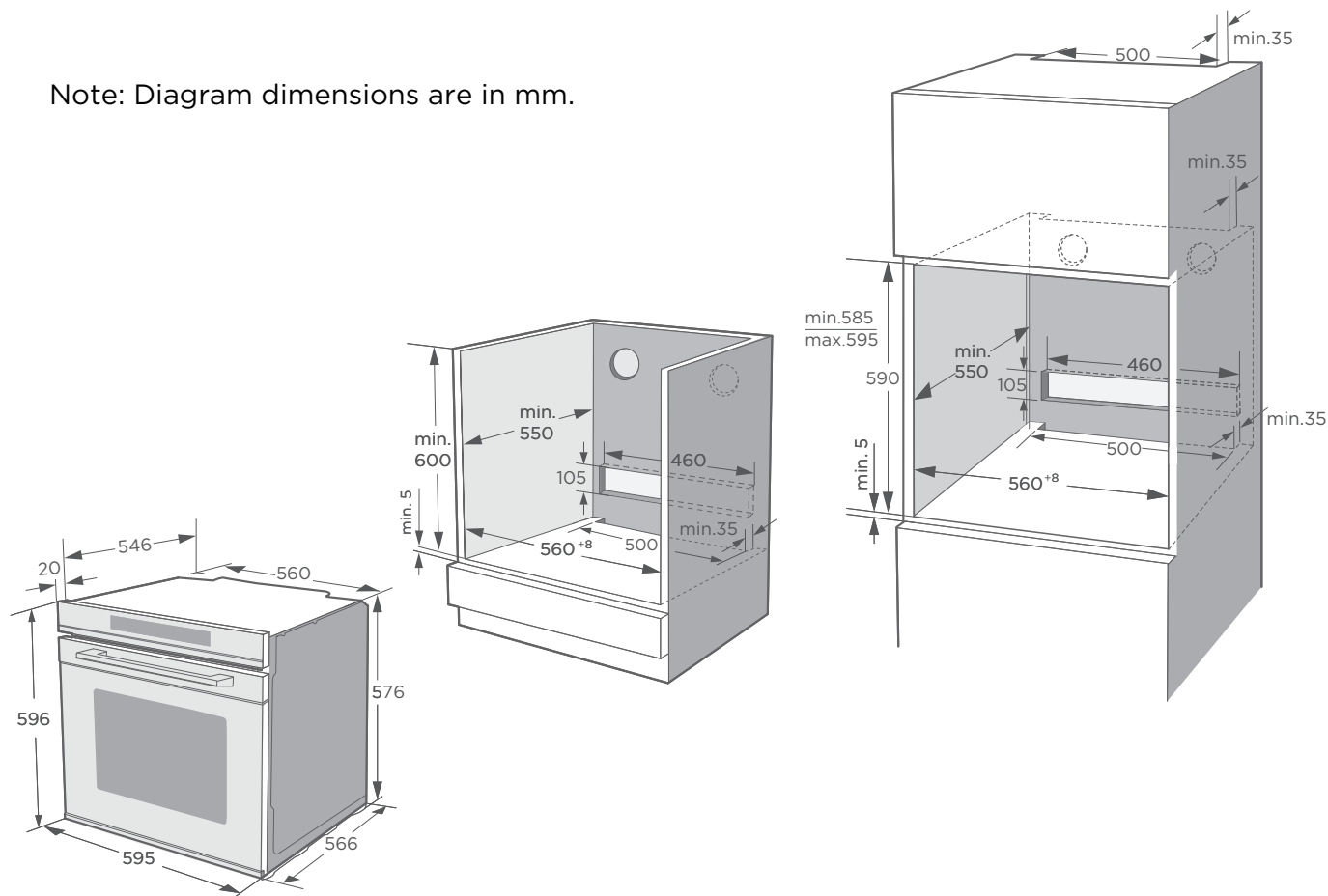

Note:

1. Only plus deviations are admissible for all dimension.
2. The cabinet does not include the power switch or socket.
3. The setback from the glass fascia to the niche front should be **20 mm**.

Please wear protective gloves to prevent yourself from being cut by sharp edges during installation. Check the appliance for any damage before commencing installation, and do not connect the appliance if there is damage. Before turning on the appliance, please remove all the packaging materials and adhesive film from the appliance. Ensure you retain all oven parts and installation accessories when disposing of packaging.

It is necessary to have the plug accessible, or incorporate a switch in the fixed wiring, in order to disconnect the appliance from the power supply when required after installation.

WARNING: In order to avoid overheating, the appliance must not be installed behind a decorative door.

FITTING THE OVEN INTO THE KITCHEN CABINET

Fit the oven into the space provided in the kitchen cabinet. It may be fitted underneath a work top or into an upright column. Fix the oven in position by screwing into place, using the two fixing holes in the frame. To locate the fixing holes, open the oven door and look inside. To allow adequate ventilation, the measurements and distances indicated in this manual must be adhered to when fixing the oven. For column installation ensure that a 35mm minimum depth full width ventilation cutout is made at the rear above the oven, and a 105 mm minimum depth full width ventilation cutout is made at the rear behind/below the oven.

SECURING THE OVEN TO THE CABINET

1. Fit oven into the cabinet recess.
2. Open the oven door
3. Secure the oven to the kitchen cabinet with two distance holders "A" which fit the holes in the oven frame and fit the two screws "B". Press the rubber caps (supplied) over the screw heads. Note: Parts A and B as above, are supplied with the oven and should not be discarded when unpacking the oven.

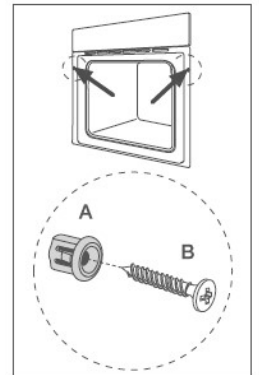

IMPORTANT

The appliance must be installed by an authorized technician and checked before use. The manufacturer is not responsible for any damage that might be caused by defective placement, and installation by unauthorized personnel. For safe oven operation and maximum efficiency, the kitchen cabinetry must be suitable. The panels of the kitchen cabinet that are next to the oven must be made of a heat resistant material. Ensure that cabinetry made of glue and veneered wood can withstand temperatures of at least 120°C. Plastics or glues that cannot withstand such temperatures will melt and deform the cabinet.

Once the oven has been lodged inside the cabinet, electrical parts must be completely insulated. This is a legal safety requirement. All guards must be firmly fixed into place so that it is impossible to remove them without using special tools. Remove the back of the kitchen cabinet to ensure an adequate current of air circulates around the oven. The oven must have a rear gap of at least 45 mm.

ELECTRICAL CONNECTION OF THE OVEN

NOTE: This appliance should be connected to the mains power supply via a standard 15A switched GPO, protected by a minimum 16A circuit breaker.

It is necessary to have the plug accessible, or incorporate a switch in the fixed wiring, in order to disconnect the appliance from the power supply when required after installation.











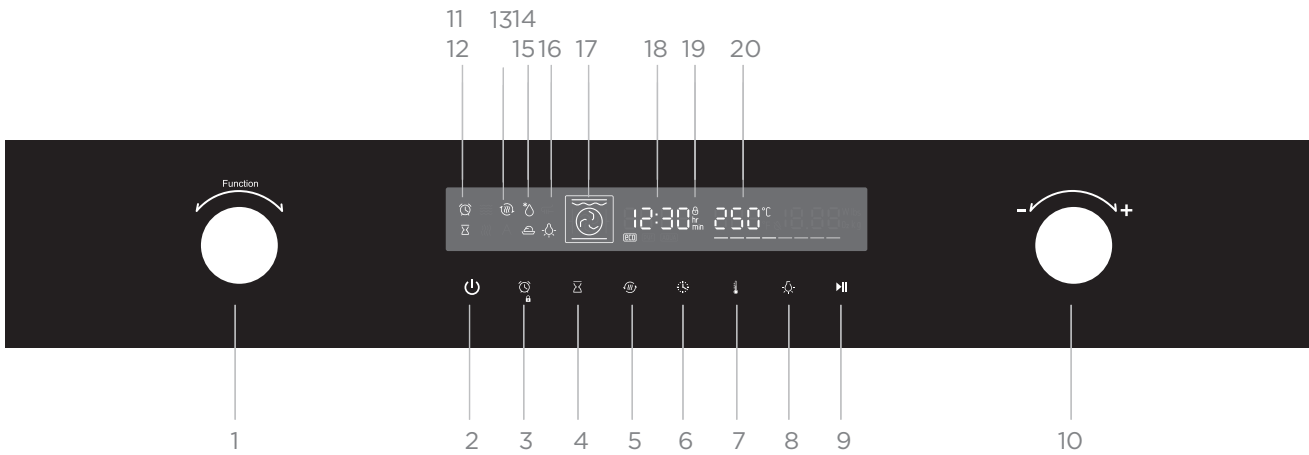

WARNING: IT MUST BE ENSURED THAT THIS APPLIANCE IS CONNECTED ONLY TO A 230VAC +10%/-6% 50Hz MAINS POWER SUPPLY WHICH CONTINUOUSLY COMPLIES WITH THE RELEVANT AUSTRALIAN STANDARD. FAILURE TO DO SO MAY SERIOUSLY DAMAGE THE APPLIANCE AND ANY SUCH DAMAGE IS NOT COVERED BY THE MANUFACTURER'S WARRANTY.



OPERATING THE APPLIANCE

CONTROL PANEL



Knobs and Function Keys	Related Indicators	Usage
1. Oven - Function Knob	14, 15, 17	Turn this knob to change cooking mode.
 2. Standby	-	Cancel the current state and enter standby mode.
 3. Timer /Child-Proof Lock	11/19	Use timer function/3 sec press for child-proof lock.
 4. End time	12	Set an end time to the cooking cycle.
 5. Boost preheat	13	Use this to preheat quickly.
 6. Duration/Clock Setting	18	Set a duration time/set clock time of day in standby mode.
 7. Temperature Setting	20	Press to set cooking temperature.
 8. Lamp ON / OFF	16	Switch the internal lamp on and off.
 9. Start / Pause	-	Start and pause the cooking process.
 10. Adjustment Knob	-	Adjust values shown in the display.

BEFORE USING THE APPLIANCE

Before using the appliance to prepare food for the first time, you must clean the cavity and accessories. See Maintaining this Appliance pp18-21 for extra instructions.

1. Remove all stickers, surface protection foils and transport protection parts.
2. Remove all accessories and the side-racks from the cavity.
3. Clean the accessories and the side-racks thoroughly using soapy water and a dish cloth or soft brush.
4. Ensure that the cavity does not contain any leftover packaging, such as polystyrene pellets or wooden piece which may cause risk of fire.
5. Wipe the smooth surfaces in the cavity and the door with a soft, wet cloth.
6. To remove the new-appliance smell, heat up the appliance when empty and with the oven door closed.
7. Keep the kitchen highly ventilated while the appliance is heating up for the first time. Keep children and pets out of the kitchen during this time. Close the door to the adjacent rooms.
8. Adjust the settings indicated below. You can find out how to set the Functions and the temperature in the next section.
→"Using Your Appliance" on page 12

Settings for first use



Functions	
Temperature	250°C
Time	1h

After the appliance has cooled down:

1. Clean the smooth surfaces and the door with soapy water and a dish cloth.
2. Dry all surfaces.
3. Install the side-racks.

Setting the time

Before the oven can be used, the time should be set.

1. Once the electrical power is connected touch the clock symbol . You can then set the time of day in hours by turning the right adjustment knob.
2. Touch the clock symbol  again to set the time in minutes by turning the right knob.
3. Touch the clock symbol  to finish the setting.

NOTE: The clock has a 24 hour display.













NOTE: Occasionally the time-of-day clock in this appliance may lose or gain time. This is due to fluctuations in the mains power supply. This is not something that can be prevented, nor will it affect the other functions or normal operation of the appliance.

Maximum operating time

The maximum operating time of this appliance is 9 hours. It will turn off automatically after this time duration, in the event the appliance is inadvertently left operating.

FUNCTIONS

This table explains the oven functions to help the user choose the correct type of heating for each dish.

Functions	Temperature	Use
 Light	–	To view interior of oven.
 Boost Preheat	–	To shorten the preheat time. Not available with defrost or dough proofing functions.
 Traditional Cooking	30~250 °C	For traditional baking and roasting on one level. Especially suitable for cakes with moist toppings.
 Convection Baking: Fan Forced	50~250 °C	For baking and roasting on one or more levels. Heat is delivered evenly from the circular element and fan.
 ECO	140~240 °C	Uses the bottom and circular elements. Saves energy during cooking.
 Intensive Cooking	50~250 °C	For baking and roasting on one or more levels. The fan distributes the heat from top and bottom heating elements evenly around the cavity.
 Full Grill	150~250 °C	For grilling small amounts of food and for browning food. Place food in the center part of the grill pan under the grill heating element.
 Fan Assisted Double Grill	50~250 °C	For grilling flat items and for browning food. The fan distributes the heat from both top elements evenly around the cavity.
 Double Grill	150~250 °C	For intense grilling of relatively flat items and for browning already cooked food.
 Pizza: fan forced lower heating element	50~250 °C	For pizza and dishes which need concentrated heat from underneath. Uses the bottom and circular elements.
 Pastry: Lower heating element	30~220 °C	For add extra browning to the bases of pizzas, pies, and pastries. Uses the bottom element.
 Defrost	–	For gently defrosting frozen food.
 Dough Proving	30~45 °C	For proving yeast dough and sourdough, and culturing yogurt.

Notes

1. To defrost large portions of food, the side-racks may be removed and the food container placed on the cavity floor.
2. To warm tableware, it is beneficial to remove the side-racks and use the heating modes “Fan Assisted Double Grill” OR “Baking: Fan Forced” with the temperature set at 50°C. “Fan Assisted Double Grill” should be used if more than half of the cavity floor is covered by the tableware.
3. Dishes should only be placed on the cavity floor in the low temperature situations as in notes 1 or 2 above. DO NOT place any dishes on the cavity floor when using other functions, especially those which use the bottom element such as Traditional Cooking, ECO, Intensive Cooking, Pizza and Pastry. This may cause damage to the oven cavity/enamel and such damage is not covered by the warranty.
4. For optimum evenness of heat distribution inside the cavity during “Baking: Fan Forced”, the fan will switch on and off during the heating process to guaranty the best possible performance.

Caution



1. If the appliance door is opened during an on-going operation press  before opening the door, or the cooking process will not pause. Please be especially careful with the risk of burns.
2. Do not cover the front ventilation slot as the appliance may overheat.
3. The cooling fan may continue to run for a time after the cooking ends, to assist the appliance to cool down rapidly.

Cooling fan

The cooling fan switches on and off as required during operation. The resulting hot air escapes above the door. This is normal.

USING YOUR APPLIANCE

Manual Cooking



1. After the oven has been connected to the power, turn the oven-function knob to select the function then turn the adjustment knob to set the cooking temperature.
2. Touch the  symbol to start the cooking process. If this is not pressed, the oven will revert to showing time of day after 10 minutes.
3. During the cooking process, you can touch  to cancel it. NB. This cancels all functions and settings.

Semi-automatic Cooking (set duration only)

After setting the temperature you can touch the clock symbol  then set the cooking duration time by turning the adjustment knob.

Automatic cooking (set duration and end time)

After setting the cooking duration, you can set a time that cooking will end.

1. Touch , then turn the adjustment knob to set the end time in hours, touch  again then set it in minutes.
2. When finished setting the time, touch  to confirm.
3. To set an end time, you first need to set the cooking duration time. Please check Semi-automatic Cooking (set duration only) on page 12 to see how to set the cooking duration time. For example, when the set end time is 10 o'clock, and the cooking duration time is 1 hour, the oven will heat up at 9 o'clock, and finish at 10 o'clock.

NOTE:  flashes to indicate the program is ready to start.

Boost preheat

You can use Boost preheat to shorten the preheat time. Select a function, touch the Boost preheat key  and the Boost preheat symbol in the display will light up. If Boost preheat doesn't operate for the selected function then the appliance will "beep". There is no Boost preheat for defrost, dough proving or "ECO" functions.

N.B. Boost preheat only works for a minimum set temperature of 100°C. When the set temperature is reached

1. The oven beeps once.
2. If the duration is set the oven continues cooking for the set duration and at the set function. If the cooking duration is not set then the oven continues cooking for up to nine hours at the set function.

To change settings during cooking

While the oven is operating, you can change the function setting and temperature setting by using the oven-function or adjustment knobs. Once the settings are changed, and there is no other action after 6 seconds, the oven will operate with the new settings.

If you want change cooking duration time during the cooking process, touch clock symbol  and change it using the adjustment knob. Once the setting is changed, if there is no other action after 6 seconds the oven will operate with the new setting. If the original cooking process had a set end time, these changes cannot be made.

To cancel the cooking process, touch  .

Caution!

Even after the appliance is switched off, it may be very hot, especially inside the cavity. Never touch the interior surfaces of the appliance or the heating elements. Use oven gloves to remove accessories or ovenware from the cavity, and allow the appliance to cool down. Keep children at a safe distance at the same time to avoid injury or burns.

Kitchen Timer

The Kitchen Timer function can be used as a reminder or alarm. It will beep at a time previously selected.



First touch  to set timer by hours, then touch  again, to set timer by minutes.

Touch  again, to confirm the setting. You can set the timer before and during the cooking process, but when you are selecting function and temperature, it's not available.

Childproof lock

Your appliance has a childproof lock so that children cannot switch it on accidentally or change any settings.

When you press for 3 seconds on the  symbol, the childproof lock is activated. Press again for 3 seconds to unlock the oven.

You can activate and deactivate the childproof lock whether or not the oven is operating. Press  for 3 seconds to switch the childproof lock on or off. When the childproof lock is on  will display in the status bar.

COOKING BY ECO MODE



ECO mode is heating using the bottom and ring elements. Using this mode can save energy during cooking.

RECIPES	Accessories	°C	Level	Time(min)	Pre-heat
Challah	1 tray	180	1	45-50	No
Pork Roast	1 tray	200	1	80-85	No
Cherry Clafoutis	Round form	200	1	55-60	No
Beef Roast 1.3kg	1 tray	200	1	80-85	No
Brownies	Rack and glass plate	180	1	55-60	No
Potato Gratin	Rack and round plate	180	1	65-70	No
Lasagne	Rack and glass plate	180	1	75-80	No
Cheese Cake	Springform Φ 20cm	160	1	80-90	No



USING SABBATH MODE

Sabbath mode

Sabbath mode supports adherence to certain religious observances. To use the Sabbath mode function:

1. In standby mode, press and hold the Boost preheating key  for 3 seconds to enter Sabbath mode. The screen displays 5P8. The time adjustment range is 24-80 hours.
2. Turn the knob to adjust the Sabbath mode duration time.
3. Press the  key to start the function or Sabbath mode will start automatically after 8 seconds.

Note:

1. During operation, only the  key is valid, and other keys are invalid.
2. During the operation of Sabbath mode the oven light will not turn on whether the oven door is open or closed.
3. Sabbath mode continues after mains power loss and restoration. Oven status is saved every 25 minutes. If the mains power is disconnected during operation, after it is restored, the Sabbath mode will continue until the set function duration expires, or the  key is pressed to return to standby mode.

Convection Hot Air Frying

To use Convection Hot Air Frying select the Convection Baking: Fan Forced function . Place the wire rack into shelf position 3 of the oven (see image). Insert an oven tray below the wire rack to collect any spills. Adding a small amount of cold water to the tray, before pre-heating the oven, will make the tray easier to clean after cooking is complete. Ensure there is separation between the wire rack and the oven tray to maximize air circulation. Do not put the oven tray on the floor of the oven.

Place the food in an open wire air frying basket and position the basket in the centre of the wire rack. Follow the directions for Fan Forced cooking on the food packet. Pre-heat the oven to the recommended temperature prior to putting the food in the oven. Failure to do so will mean the food will not be sufficiently cooked. Do not use the packet directions for use with an Air Fryer.

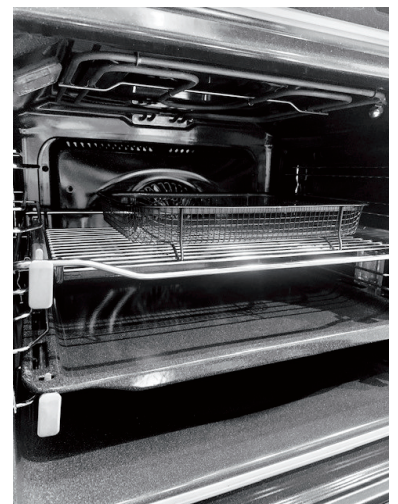

ACCESSORIES

Your appliance is accompanied by a range of accessories. This section contains an overview of the accessories included and information on how to use them correctly.

Accessories included

Your appliance is equipped with the following accessories:



Wire Rack x2

For ovenware, cake tins and ovenproof dishes. For roasts and grilled food.

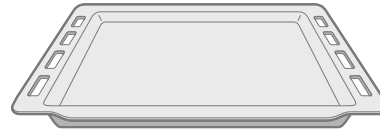

Deep Baking Tray (50mm) x1

For tray bakes and small baked products.

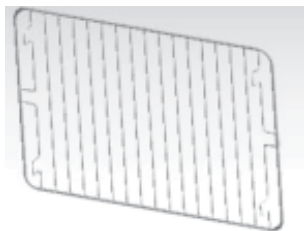

Grill pan inset x1: For grilling and roasting. Place the wire insert in the baking tray with the feet facing downwards. This ensures that dripping fat and juices are collected.

One level of telescopic guides - see pp 25-26 for installation instructions.

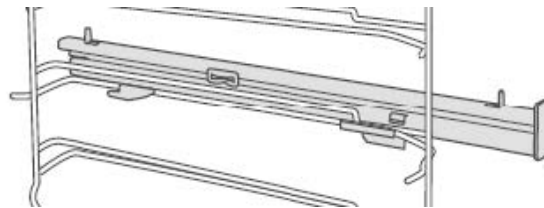

You can use the tray to hold liquid, or for cooking food containing juice or moisture. Only use original accessories. They are specially designed for your appliance. You can buy replacement accessories from after-sales service. See back cover of this manual for details.

Note

The accessories may change shape slightly when they become hot. This does not affect their function. Once they have cooled down again, they regain their original shape.

Inserting accessories

The cavity has five shelf positions. The shelf positions are counted from the bottom up. See Fig 2 on the following page.

The accessories can be extracted approximately halfway without tilting, unless the accessory is resting on a telescopic guide, which allows it to be fully extracted without tilting.

Notes

1. Ensure that you always insert the accessories into the cavity the right way round. See Fig. 1-4 on the following page.
2. Always insert the accessories fully into the cavity so that they do not touch the appliance door when it is closed.

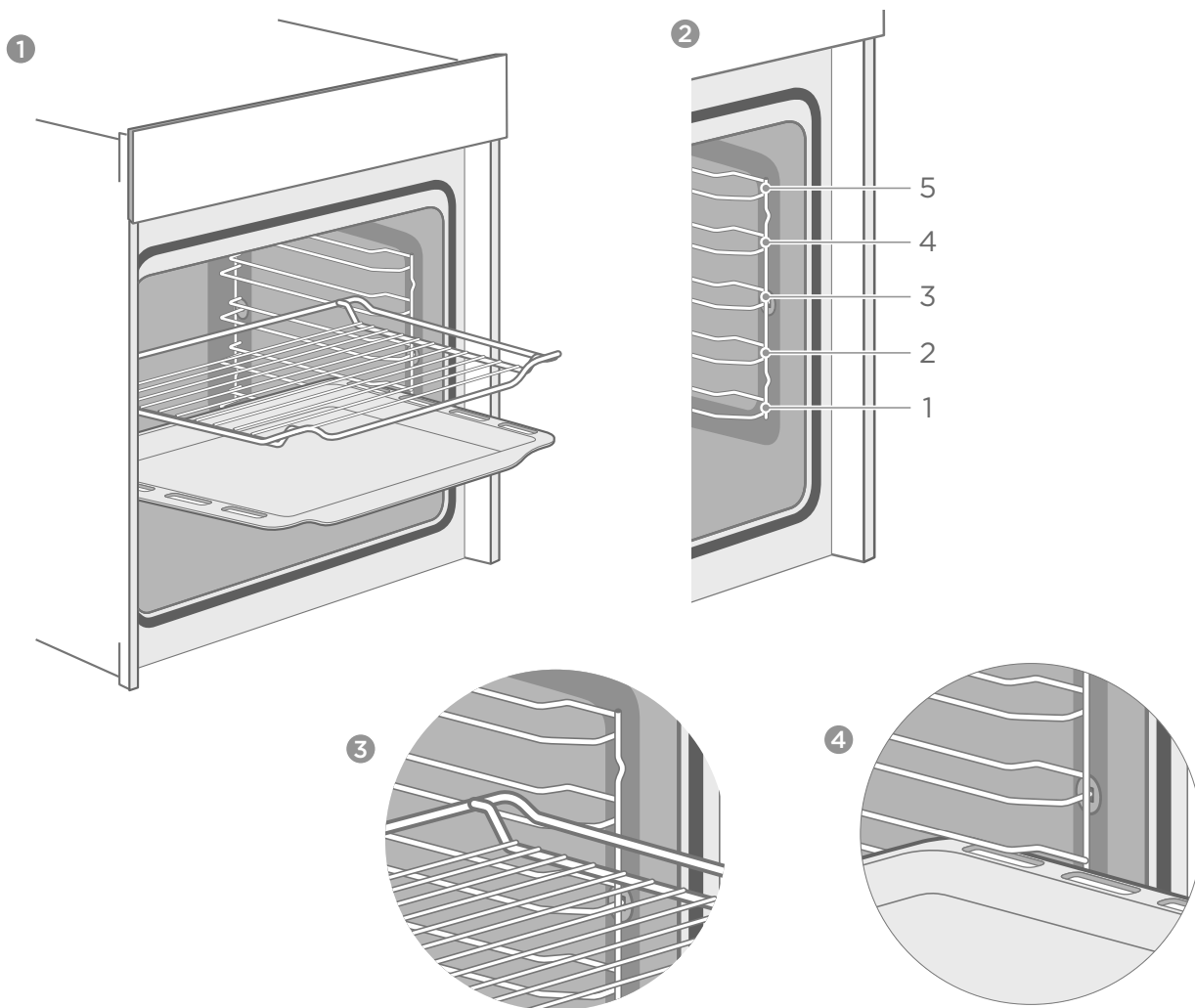

Locking feature

Accessories can be pulled approximately halfway out until they lock in place. The locking function prevents accessories from tilting with the gravity of food and accessories themselves while they get pulled out. Accessories should be inserted into cavity correctly for this tilt protection.

When inserting the wire rack, ensure the wire rack is fitted facing the correct direction as in Figs. 1 and 3 above.

When inserting the baking tray, ensure the baking tray is fitted facing the correct direction as in Figs. 1 and 4 above.

Safe-T-Stop

When fully extracted, there is a slight detent at the fully extracted position which helps prevent the accessory from accidentally sliding back into the oven until required.

ENERGY EFFICIENT USE

1. Remove all accessories which are not necessary during the cooking & baking process.
2. Do not open the door during the cooking & baking process.
3. If you open the door during cooking & baking, switch the mode to “Lamp” (without changing the temperature setting).
4. Decrease the temperature setting in non-fan assisted modes to 50°C at 5min to 10min before end of cooking & baking time. The cavity heat will then be used to complete the cooking process.
5. Use “Baking: Fan Forced, whenever possible. You can reduce the temperature by 20°C to 30°C. You can cook and bake using “Baking: Fan Forced” on more than one level at the same time.
6. If it is not possible to cook and bake different dishes at the same time, heat one immediately after the other to use the preheated status of the oven.
7. Do not preheat the empty oven if it is not required.
8. When preheating put the food into the oven immediately after it reaches the set temperature.
9. Do not use reflective foil, e.g. aluminum foil to cover the cavity floor.
10. Use the timer whenever possible.
11. Use dark matt finish and light weighted baking molds and containers. Try not to use heavy accessories with shiny surfaces, like stainless steel or aluminum.

MAINTAINING THIS APPLIANCE

Cleaning Agent

With good care and cleaning, your appliance will retain its appearance and remain fully functional for a long time. Follow the instructions below to correctly care for and clean your appliance.

To ensure that the different surfaces are not damaged by using the wrong cleaning agent, be guided by the information in the table of cleaning suggestions on the following 2 pages.

Caution!

Risk of surface damage

Do not use:

1. Harsh or abrasive cleaning agents.
2. Cleaning agents with a high alcohol content.
3. Hard scouring pads or cleaning sponges.
4. High-pressure cleaners or steam cleaners.
5. Special cleaners for cleaning the appliance while it is hot.

Wash new sponge cloths thoroughly before use.

Tip

Observe the respective cleaning product manufacturer's instructions on usage.

Surface Area	Cleaning
Appliance exterior Stainless steel front	Use hot soapy water: Clean with a dish cloth and then dry with a soft cloth. Remove flecks of lime scale, grease, starch and albumin (e.g. egg white) immediately. Corrosion can form under such flecks. Special stainless steel cleaning products suitable for cleaning surfaces which may become hot are available from specialist retailers. Apply a very thin layer of the cleaning product with a soft cloth, following the manufacturer's instructions.
Plastic	Use hot soapy water: Clean with a dish cloth and then dry with a soft cloth. Do not use glass cleaner or a glass scraper.
Painted surfaces	Use hot soapy water: Clean with a dish cloth and then dry with a soft cloth.
Control panel	Use hot soapy water: Clean with a dish cloth and then dry with a soft cloth. Do not use glass cleaner or a glass scraper.
Door panels	Use hot soapy water: Clean with a dish cloth and then dry with a soft cloth. Do not use a glass scraper or a stainless steel scouring pad.

Surface Area	Cleaning
Door handle	Use hot soapy water: Clean with a dish cloth and then dry with a soft cloth. If descaler comes into contact with the door handle wipe it off immediately, otherwise any stains will not be able to be removed.
Enamel surfaces	Use hot soapy water: Clean with a dish cloth, wipe with a damp cloth, then dry with a soft cloth. Observe the instructions for the surfaces of the cooking compartment that follow the table. See Notes below.
Glass cover for the interior lighting	Use hot soapy water: Clean with a dish cloth and then dry with a soft cloth. If the cooking compartment is heavily soiled oven cleaner may be used.
Door seal Do not remove	Use hot soapy water: Clean with a dish cloth. Do not scour.
Stainless steel door cover	Use Stainless steel cleaner only. Do not use other stainless steel care products. Observe the manufacturer's instructions. Remove the door cover for cleaning.
Accessories	Use hot soapy water: Soak and clean with a dish cloth or brush. If there are heavy deposits of dirt use a stainless steel scouring pad.
Rails	Use hot soapy water: Soak and clean with a dish cloth or brush.
Telescopic Guides	Use hot soapy water: Clean with a dish cloth or a brush. Do not remove the lubricant while the Telescopic Guides are pulled out. It is best to clean them when they are pushed in. Do not clean in the dishwasher.

Notes

1. Slight differences in colour on the front of the appliance are caused by the use of different materials, such as glass, plastic and metal.
2. Shadows on the door panels, which look like streaks, are caused by reflections made by the interior lighting.

3. Warning: Do not use a rough or sharp metal scraper to clean the glass of the oven door. If the glass surface of the oven door gets scratched this can cause the glass to shatter.
4. Enamel is baked on at very high temperatures. This can cause some slight colour variation. This is normal and does not affect operation. The edges of thin trays cannot be completely enameled. As a result, these edges can be rough. This does not impair the anti-corrosion protection.
5. Always keep the appliance clean and remove dirt immediately so that stubborn deposits of dirt do not build up.
6. Do not use hard objects such as wire brushes to clean any part of this appliance.

Tips

1. Clean the cooking compartment after each use. This will ensure that dirt is not baked on.
2. Always remove flecks of lime scale, grease, starch and albumin (e.g. egg white) immediately.
3. Remove flecks of food with sugar content immediately, if possible, when the fleck is still warm.
4. Use suitable ovenware for roasting, e.g. a roasting dish.

APPLIANCE DOOR

Follow the instructions below to remove the appliance door for cleaning.

For cleaning purposes and to remove the door panels, you can detach the appliance door. The appliance door hinges each have a locking lever. When the locking levers are closed, the appliance door is secured in place. It cannot be detached. When the locking levers are open in order to detach the appliance door, the hinges are locked. They cannot snap shut. See Fig 1 & 2 below.

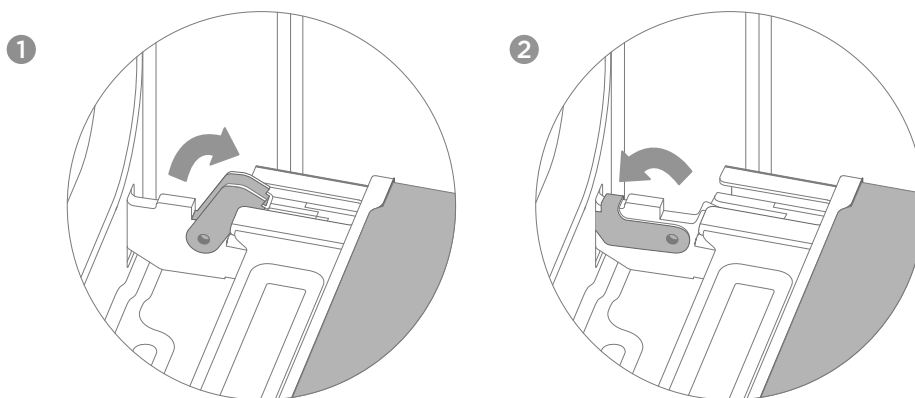

Warning – Risk of injury!

1. If the hinges are not locked, they can snap shut with great force. Ensure that the locking levers are always fully closed or, when detaching the appliance door, fully open.
2. The hinges on the appliance door move when opening and closing the door, and you may be trapped. Keep your hands away from the hinges.

Removing the appliance door

1. Open the appliance door fully.
2. Fold open the two locking levers on the left and right. See Fig. 1 below.
3. Close the appliance door as far as the limit stop.
4. With both hands, grip the door on the left- and right-hand side, and pull it out upwards.

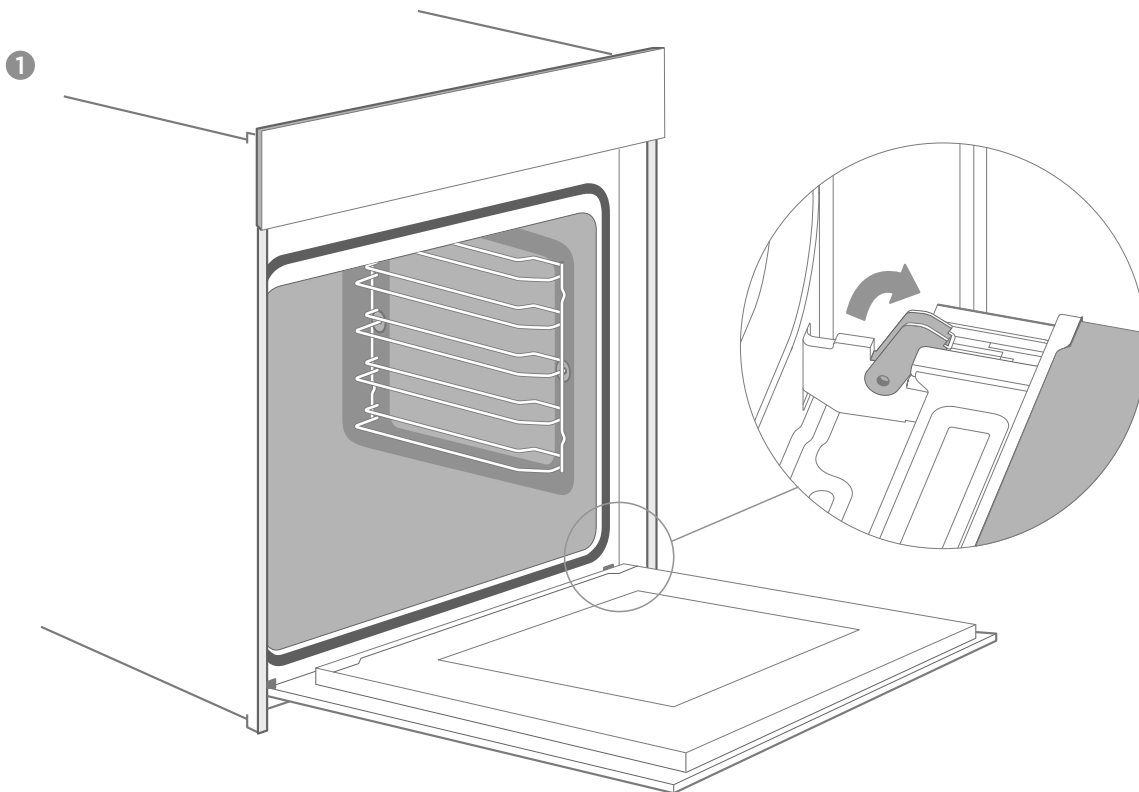

Fitting the appliance door

Reattach the appliance door in the opposite sequence to removal.

1. When attaching the appliance door, ensure that both hinges are placed right onto the installing holes of the front panel of the cavity. See Fig. 2 on next page. Ensure that the hinges are inserted into the correct position. You must be able to insert them easily and without resistance. If you can feel any resistance, check that the hinges are inserted correctly into the holes.
2. The locking lever which is used to lock the hinges to allow the door to be removed, needs to be returned to the fully locked position (ie returned to the horizontal alignment, and then firmly pushed down into final position) before the door is again operated. If this step is not performed correctly damage to the oven may occur. See figures 1 & 2 on page 21.
3. Open the appliance door fully. While opening the appliance door, confirm that the hinges are in the right position. If they are fitted incorrectly, the appliance door will not fully open. Fold both locking levers closed again, ensuring that are pushed all the way down.
4. Close the cooking compartment door. Make a final check to ensure the door is in the right position and that the ventilation slots are not obstructed.

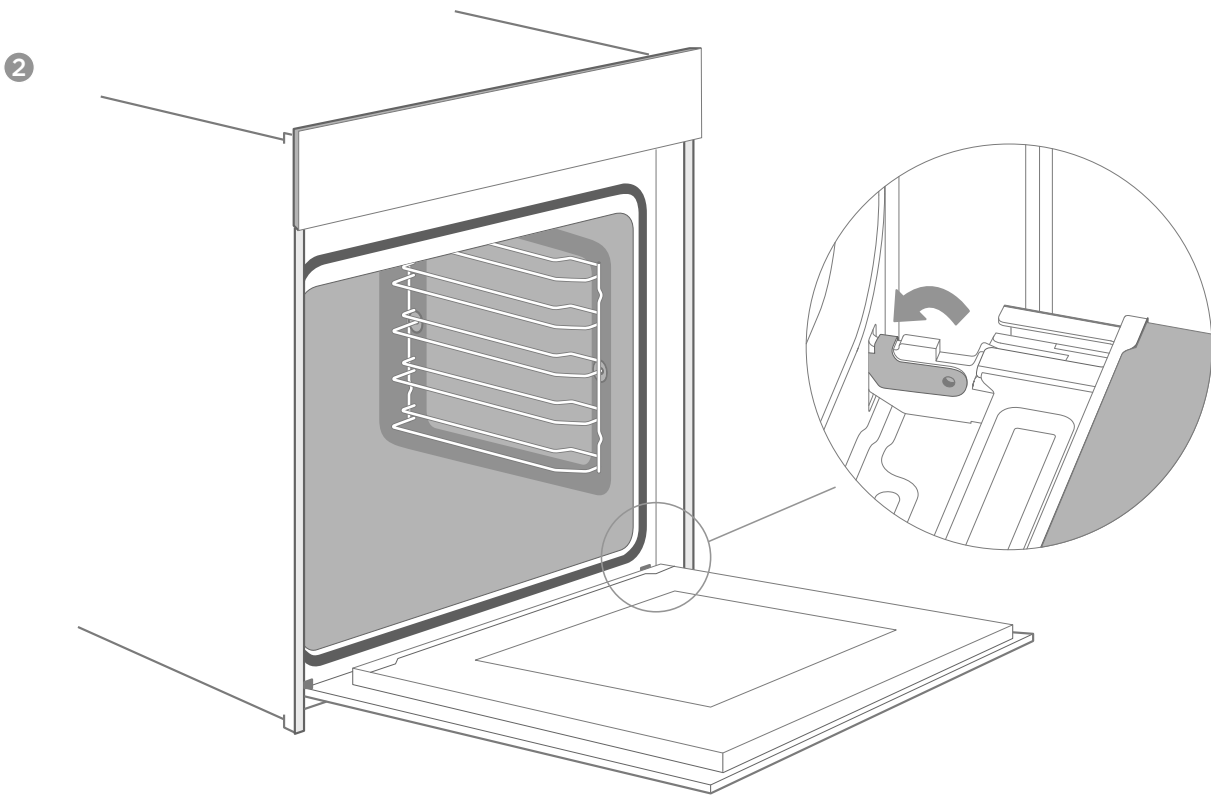

Removing the door cover

The plastic inlay in the door cover may become discolored. The cover may be removed to thoroughly clean it.

Remove the appliance door as instructed above.

1. Press on the right and left side of the cover. See Fig.1 below.
2. Remove the cover. See Fig.2 below.
3. After removing the door cover, the remaining parts of the appliance door can be easily taken off to clean all parts. When the cleaning is complete put the cover back in place and press on it until it clicks audibly into place. See Fig.3 below.
4. Fit the appliance door and close it following the instructions on the previous page.

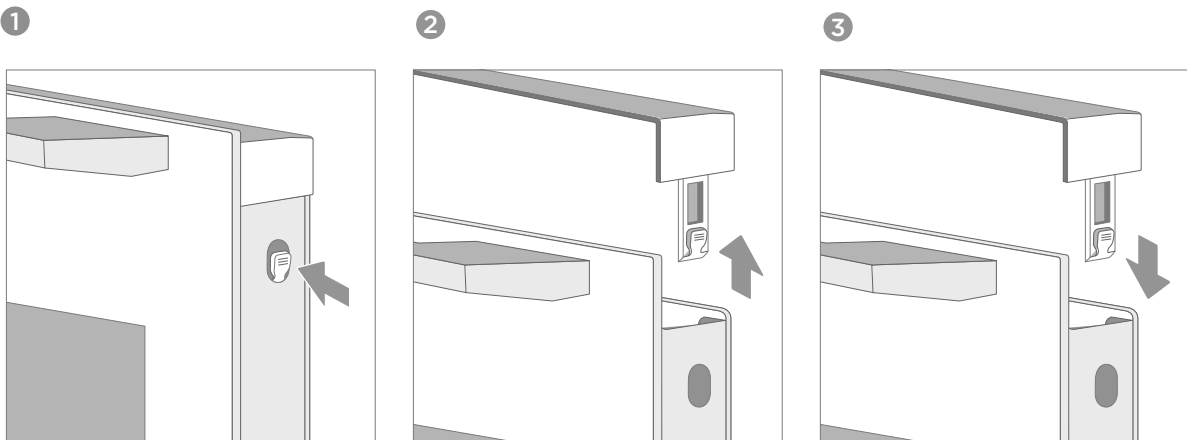

Caution!

It is possible to remove the door cover when the door is installed on the oven, however:

1. Removing the door cover releases the inner glass of the door so that it can easily move leading to damage or injury.
2. Removing the door cover and inner glass reduces the overall weight of the door. The hinges may move more when the door is being closed and body parts may be trapped. Keep your hands away from the hinges.

For these reasons it is strongly recommended that the door cover is not removed unless the door has been removed from the oven. Damage caused by incorrect operation is not covered under warranty.

Rails

The shelves and rails may be removed periodically to allow the oven cavity to be thoroughly cleaned and retain its appearance and functionality.

Follow the steps in Fig.1 below to detach the rails and perform them in reverse to reattach them.

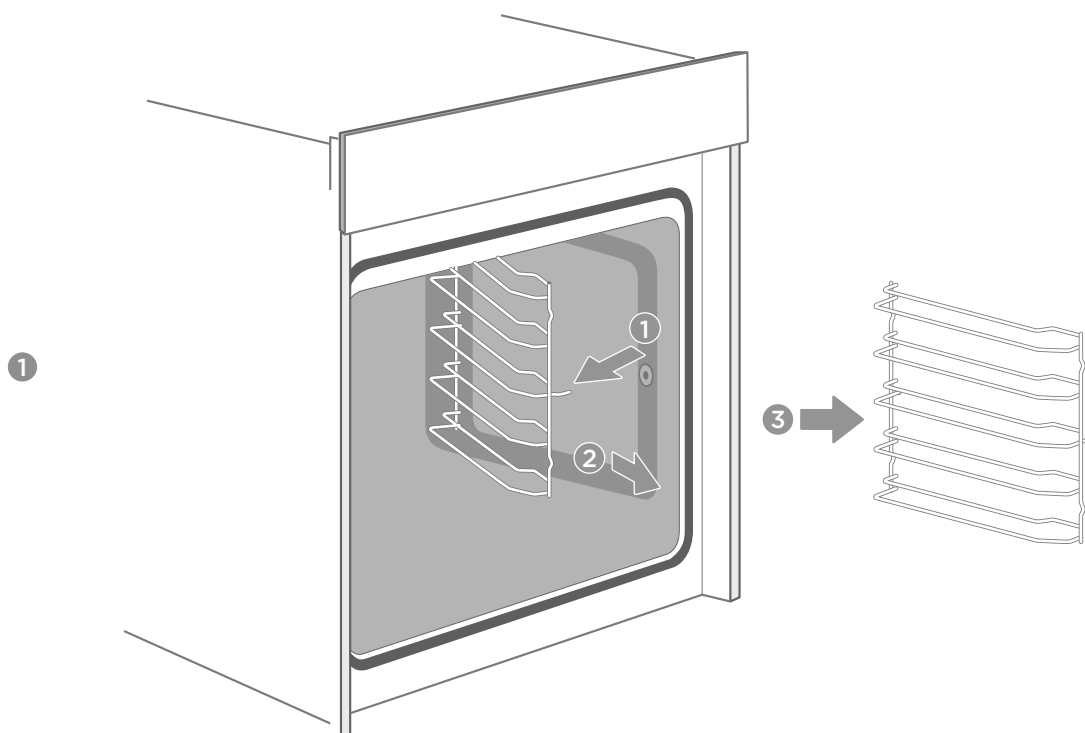

INSTALLING THE TELESCOPIC GUIDES

These instructions are for the left side of the cavity. Use a similar method to install guides on the right side.

1. Place the point A and B of the telescopic guides horizontally on the outer wire. Fig.1
2. Rotate the telescopic guides anti-clockwise (clockwise for right side) by 90 degrees. Fig.2
3. Push the telescopic guides toward the rear of the oven cavity so that point C is attached to the lower wire and point D is attached to the upper wire. Fig.3

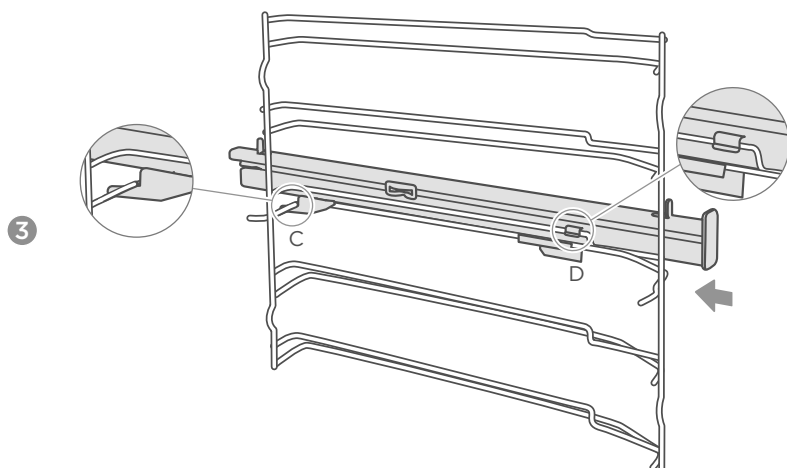
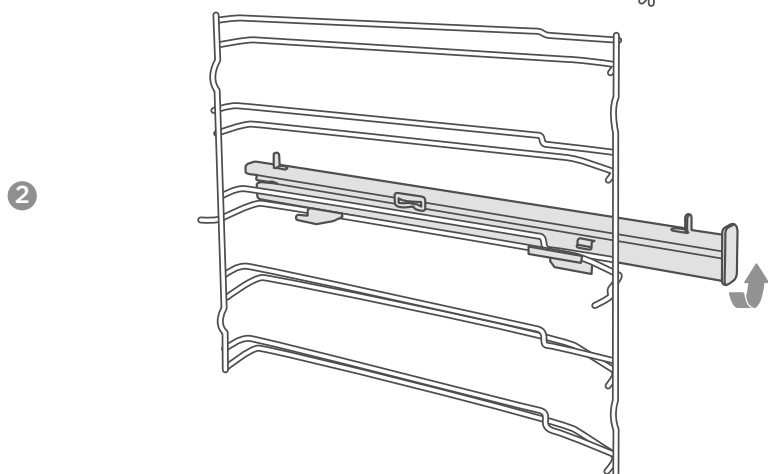
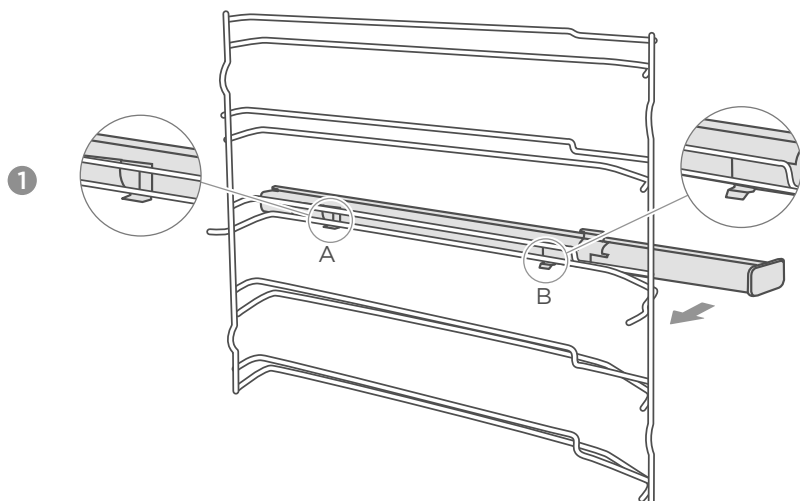

REMOVING THE TELESCOPIC GUIDES

These instructions are for the left side of the cavity. Use a similar method to remove the guides on the right side.

1. Lift up the front end of the telescopic guide firmly. To do this, the special release latch first needs to be pressed towards the wall of the cavity. See Fig.1
2. Move the entire telescopic guide toward the front of the oven and remove it from the side racks. Fig.2

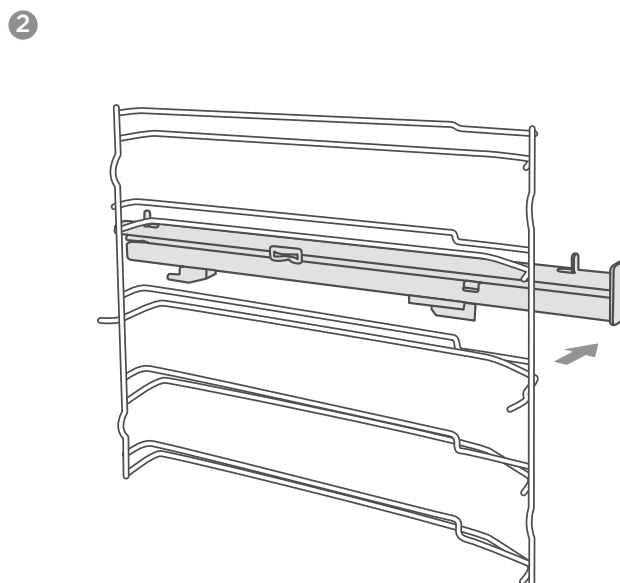
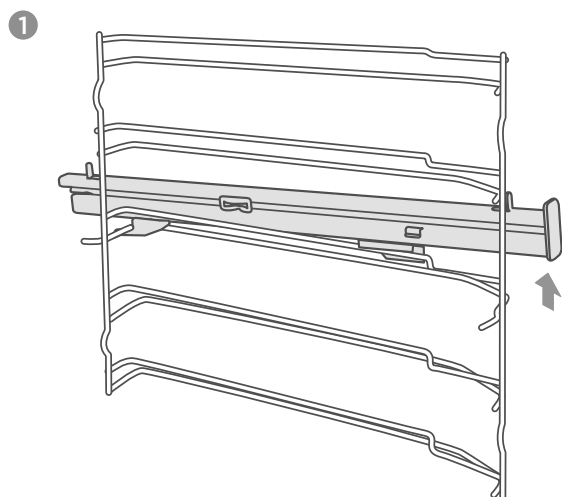

Replacing Oven Lamp

If the oven lamp fails, it must be replaced. Heat-resistant, 25 watt, 230 V halogen lamps are available from specialist retailers.

When handling the halogen lamp, use a dry cloth. This will increase the service life of the lamp.

WARNING

Risk of electric shock!

When replacing the lamp, be aware that the lamp socket contacts are live. Before replacing the lamp, unplug the appliance from the mains or switch the circuit breaker in the fuse box.

Risk of burns!

The appliance becomes very hot. Never touch the interior surfaces of the appliance or the heating elements. Always allow the appliance to cool down. Keep children at a safe distance.

1. Place a towel in the base of the cold cavity to prevent damage.
2. Turn the glass cover anti-clockwise to remove it.
3. Pull out the lamp - do not turn it.
4. Insert the replacement lamp.
5. Replace the glass cover.
6. Remove the towel and switch on the power to ensure the lamp is operating.

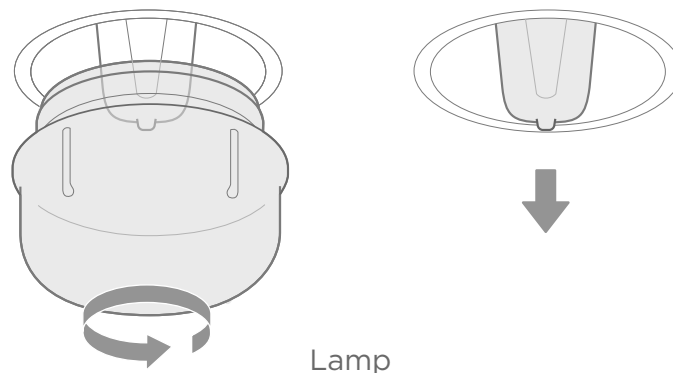

Glass cover

If the glass cover of the halogen lamp is damaged, it must be replaced. You can obtain a new glass cover from Customer Support. See back cover of manual for details.

TROUBLE SHOOTING GUIDE

Repairs should be performed by a licensed technician only as incorrect repair may result in considerable danger to you and others. However if a fault occurs, before contacting the service department, please ensure that it is not due to incorrect operation. Some minor problems can be resolved as in the table below:

Fault	Possible Cause	Notes/remedy
The appliance does not work.	Faulty fuse.	Check the circuit breaker in the fuse box.
	Power cut	Check whether other kitchen appliances are working.
Knobs have fallen out of the support in the control panel.	Knobs have been accidentally disengaged.	Knobs can be removed. Simply place knobs back in their support in the control panel and push them in so that they engage and can be turned as usual.
Knobs can no longer be turned easily.	There is dirt under knobs	Knobs can be removed. To disengage knobs, simply remove them from the support. Alternatively, press on the outer edge of knobs so that they tip and can be picked up easily. Carefully clean the knobs using a cloth and soapy water. Dry with a soft cloth. Do not use any sharp or abrasive materials. Do not soak or clean in the dishwasher. Do not remove knobs too often so that the support remains stable
Fan does not work all the time in the mode: "Baking: Fan Forced"		The fan will switch on and off during this function. This is a normal operation to ensure the best possible heat distribution and best possible performance of the oven.
After a cooking process a sound can be heard and air flow near of the control panel can be observed.		The cooling fan is still working, to prevent high moisture conditions in the cavity and cool down the oven for your convenience. The cooling fan will switch off automatically.
The food is not sufficient cooked in the time given by the recipe .		A temperature different from the recipe may have been used. Double check the temperatures. The ingredient quantities are different to the recipe. Double check the recipe.
Uneven browning		The temperature setting is too high, or the shelf level could be optimized. Double check the recipe and settings. The surface finish and or colour and or material of the baking ware may not be the best choice for the selected oven function. When use radiant heat, such as Traditional Cooking mode, use matt finished, dark colored and light weight oven ware.
The lamp doesn't turn on		The lamp needs to be replaced.

Fault	Possible Cause	Notes/remedy
Oven responds to control panel actions except that the heating elements do not activate, and the standby screen includes a permanently displayed short horizontal segment to the right of the clock display.	The oven may be in Retail Showroom Mode.	Press and hold the Power On/Off sensor for 10 sec. Within the following 3 sec. turn the adjustment knob to the left to turn off the demonstration mode. On or off will show on the display screen when the knob is turned.

Warning-Risk of electric shock!

Incorrect repairs are dangerous. Repairs should only be carried out, and damaged power cables replaced, by a qualified technician. If the appliance is defective, unplug the appliance from the mains or switch off the circuit breaker in the fuse box. Contact Customer Service. See page 30.

CUSTOMER SERVICE

If the appliance fails to operate correctly during the warranty period please visit our website to request a warranty service (see back cover of this manual for details). When booking a service please provide your Model No and the individual Serial Number of your appliance, which are found on the rating plate. The rating plate bearing these numbers can be found when you open the appliance door.

Model: OMF6040K and OMF6040X

Rated voltage: 220-240V~

Rated frequency: 50Hz-60Hz

Electric power: 2.9 kW



To save time, you can make a note of the model of your appliance and the telephone number of the aftersales service in the space below, should it be required.

APPLIANCE DETAILS

Model number		Purchase date	
Serial number		Place of purchase	

Warning

This appliance shall be installed in accordance with the regulations in force and only used in a well ventilated space. Read the instructions before installing or using this appliance.

COOKING & BAKING - HELPFUL SUGGESTIONS

<p>You want to cook your own recipe.</p>	<p>Try to use settings of similar recipes first and optimize the cooking process according to the result.</p>
<p>Is the cake completely baked?</p>	<p>Put a wooden skewer inside the cake about 10 minutes before the given baking time is reached. If there is no raw dough on the stick after pulling it out, the cake is ready.</p>
<p>The cake loses massive volume during cooling down after baking.</p>	<p>Try to lower the temperature setting by 10°C and double check the food preparing instructions regarding the mechanical handling of the dough.</p>
<p>The height of the cake in the middle is much higher than at the outer ring.</p>	<p>Do not grease the outer ring of the spring form tin.</p>
<p>The cake is too brown on the top.</p>	<p>Use a lower shelf level and/or use a lower set temperature. (This may lead to a longer cooking time.)</p>
<p>The cake is too dry.</p>	<p>Use a 10°C higher set temperature. (This may lead to a shorter cooking time.)</p>
<p>The food looks good but the humidity inside is too high.</p>	<p>Use a 10°C lower set temperature, which may lead to a longer cooking time, and double check the recipe.</p>
<p>The browning is uneven.</p>	<p>Use a 10°C lower set temperature. (This may lead to a longer cooking time.) Use the “Traditional Cooking” mode on one level.</p>
<p>The cake is less browned on the bottom</p>	<p>Choose a shelf one level down.</p>
<p>Baking on more than one level at the same time: Food on one shelf is darker than the other.</p>	<p>Use a fan assisted mode for baking at more than one level and take out the trays individually when ready. All trays do not need to be ready at the same time.</p>
<p>Condensation appears during baking.</p>	<p>Steam is part of baking and cooking and moves normally out of the oven together with the cooling air flow. This steam may condensate at different surfaces of the oven or near to the oven and form water droplets. This is a physical process and cannot be avoided completely.</p>

<p>Which kind of baking ware can be used?</p>	<p>Any heat resistant baking ware can be used. It is recommended not to use aluminum in direct contact with food, especially when it is sour/acidic. Please ensure a good fit between the container and its lid.</p>
<p>How to use the grill function?</p>	<p>Preheat the oven for 5 minutes and place the food in the level given in this manual. Close the oven door when you use any grilling mode. Do not use the oven when the door is open, except to load/remove/check the food.</p>
<p>How to keep the oven clean during grilling ?</p>	<p>Use the tray filled with 2 litres of water at level 1. Nearly all fluids that drip down from the food placed on the rack will be captured by the tray.</p>
<p>The heating element in all grilling modes is switching on and off during the process.</p>	<p>It is a normal operation and depends on the temperature setting.</p>
<p>What happens if a fluid is poured to a food in the oven during the baking or cooking process?</p>	<p>The fluid will boil and steam will arise as a normal physical process. Be careful, because the steam is hot. See also “Condensation appears during baking” for more information. If the fluid contains alcohol, the boiling process will be quicker and can lead to flames in the cavity. Make sure that the oven door is closed during such processes. Control the baking or cooking process carefully. Open the door very gently and only if necessary.</p>

SUGGESTED OVEN SETTINGS BY RECIPE TYPE

CAKE	Form	Level	Mode	Temp.in °C	Duration in minutes
Sponge Cake (simple) in a Box shape	Box	2	Intensive Cooking	170	50
Sponge Cake (simple) in a Box shape	Box	1	Traditional Cooking	140	70
Sponge Cake with Fruits in a round Form	Round form	1	Intensive Cooking	150	50
Sponge Cake with Fruits on a Tray	Tray	1	Traditional Cooking	140	70
Raisin Brioche Muffins (Yeast Cake)	Muffin form	2	Traditional Cooking	220	p.h.t.:19:00 b.t.: 11:00
Gugelhupf (with Yeast)	Tray	1	Traditional Cooking	150	p.h.t.:11:00 b.t.:60:00
Muffins	Muffin form	1	Traditional Cooking	160	p.h.t.: 8:30 b.t.: 30:00
Muffins	Muffin form	1	Intensive Cooking	150	p.h.t.: 8:30 b.t.: 30:00
Apple Yeast Cake on a Tray	Tray	1	Intensive Cooking	160	p.h.t.: 10:00 b.t.: 42:30
Water Sponge Cake (6 Eggs)	Spring form	1	Traditional Cooking	160	p.h.t.: 9:30 b.t.: 41:00
Water Sponge Cake (4 Eggs)	Spring form	1	Traditional Cooking	160	p.h.t.: 9:00 b.t.: 26:00
Water sponge Cake	Spring form	1	Traditional Cooking	160	35
Apple Yeast Cake on a Tray	Tray	2	Intensive Cooking	150	p.h.t.: 8:00 b.t.: 42:00
Hefezopf (Callah)	Tray	2	Intensive Cooking	150	40

Note : p.h.t means preheat time, b.t. means baking time.

CAKE	Form	Level	Mode	Temp.in °C	Duration in minutes
Small Cakes 20	Tray	2	Convection Baking	150	36
Small Cakes 40	Tray	2+4	Convection Baking	150	p.h.t.:10:00 b.t.:34:00
Butter Yeast Cake	Tray	2	Traditional Cooking	150	p.h.t.: 8:00 b.t.: 30:00
Shortbread	Tray	2	Traditional Cooking	170	p.h.t.: 8:00 b.t.: 13:00
Shortbread 2 Trays	Tray	2+4	Intensive Cooking	160	p.h.t.:8:20 b.t.: 12:00
Vanilla Cookies	Tray	2	Traditional Cooking	160	p.h.t.: 8:00 b.t.: 10:00
Vanilla Cookies	Tray	2+4	Intensive Cooking	150	p.h.t.:8:00 b.t.: 14:00
BREAD	Form	Level	Mode	Temp.in °C	Duration in minutes
White Bread (1 kg Flour) Box shape	Box	1	Traditional Cooking	170	p.h.t.: 9:20 b.t.: 50:00
White Bread (1 kg Flour) Box shape	Box	1	Intensive Cooking	170	p.h.t.: 12:00 b.t.: 45:00
Fresh Pizza (thin)	Tray	2	Traditional Cooking	170	p.h.t.: 9:30 b.t.: 21:00
Fresh Pizza (thick)	Tray	2	Traditional Cooking	170	p.h.t.:10:00 b.t.: 45:00
Fresh Pizza (thick)	Tray	2	Intensive Cooking	170	p.h.t.:8:00 b.t.: 41:00
Frozen Pizza x2	Tray	2 & 3	Pizza	190-220	p.h.t.:10:00 b.t.:10-20
Fresh Pizza (thick)	Tray	2	Pizza	225	p.h.t.:15:00 b.t.:20-30
Bread	Tray	1	Convection Baking	190	p.h.t.:9:00 b.t.:30:00

Note : p.h.t means preheat time, b.t. means baking time.

MEAT	Form	Level	Mode	Temp.in °C	Duration in minutes
Beef Tender Loin 1,6 kg	Tray	2	Fan Assisted Double Grill	180	55
Meatloaf 1 kg Meat	Tray	1	Traditional Cooking	180	75
Chicken 1 kg	Tray	L2:Rack L1:Tray	Fan Assisted Double Grill	180	50
Fish (2,5 kg)	Tray	2	Traditional Cooking	170	70
Tomahawk Rib- eye steak	Tray	3	Convection Baking	120	85
Roast Pork neck (1,2kg)	Tray	1	Convection Baking	160	82
Chicken 1,7kg	Tray	L2:Rack L1:Tray	Convection Baking	180	78

SPECIFICATIONS

OMF6040K and OMF6040X

No of Cavities	1
Power Source	Electric 220-240V~, 50Hz-60Hz
Absorbed Power	2.9kW
EC Electric, Cavity (Conventional)	1.06kWh/cycle
EC Electric, Cavity (Forced Air)	0.69kWh/cycle
Gross Internal Cavity	82L
Energy Efficiency Class (A+++ to D)	A+

ENVIRONMENT

The packaging is made to protect your new appliance against damage during transport. The materials used are selected carefully and should be recycled. Recycling reduces the use of raw materials and waste. Electrical and electronic appliances often contain valuable materials. Please do not dispose of them with your household waste.



KLEENMAID WARRANTY

TERMS AND CONDITIONS

1. Compass Capital Services Pty Ltd ABN 96 138 214 525 trading as Kleenmaid will provide parts and labour to you the customer as set out herein.
2. Kleenmaid may engage a Service Agent to provide service under this warranty.
3. Kleenmaid's Products come with guarantees that cannot be excluded under the Australian Consumer Law. You are entitled to a replacement or refund for a major failure and for compensation for any other reasonably foreseeable loss or damage. You are also entitled to have the goods repaired or replaced if the goods fail to be of acceptable quality and the failure does not amount to a major failure.
4. The benefits given to you under this Kleenmaid Warranty are in addition to other rights and remedies to which you may be entitled under the Australian Consumer Law in relation to the Product to which this Kleenmaid Warranty relates. Subject to the conditions below, the Product is warranted by Kleenmaid and/or its agents to be free from defects in materials and workmanship for the Warranty Period for normal Domestic Use.
5. Product Identification: -
 - a. Kleenmaid reserves the right to reject claims for any services or work where you cannot produce for verification the serial number and a proof of purchase for the Product (including but not limited to the original invoice).
 - b. this Kleenmaid Warranty will be voided if the serial number for the Product cannot be verified. This is not intended to exclude, restrict or modify any right or remedy to which you may otherwise be entitled under the consumer guarantee provisions of the Australian Consumer Law.
 - c. in the event that a request for repair is made against this Kleenmaid Warranty where the serial number for the Product cannot be verified or you cannot produce for verification a proof of purchase for the Product (including but not limited to the original invoice), the repairer will not carry out any repairs on the Product and you will be charged a service call-out fee.
6. What is covered by this Kleenmaid Warranty: -
 - a. the Product is covered for faulty workmanship or parts that have failed under normal Domestic Use.
 - b. Kleenmaid and/or its agents will determine by objective testing if there are any defects in the Product and/or faulty workmanship.
 - c. this Kleenmaid Warranty is only applicable if repairs on Products are carried out within Mainland Australia.
 - d. this Kleenmaid Warranty: -
 - i. covers a Product purchased as new, manufactured for use in Mainland Australia;
 - ii. commences from the date of delivery of the Product;
 - iii. provides for the labour and replacement parts necessary to maintain the Product in good operating condition as specified in this Kleenmaid Warranty, however, if repair is needed because of Product failure during normal Domestic Use, Kleenmaid has the option to repair or replace the defective Product or part of the Product with a product or part of like kind and quality. A replacement part may be new or reconditioned of like kind and quality and may cost less than the original Product purchased and no charges or refunds will be made based on the replacement product or part cost difference; and
 - iv. is only applicable when the Product is used and operated in accordance with the Manufacturer's instructions.
7. What is not Covered by this Kleenmaid Warranty (excluded):-
 - a. any damage or failure to or of the Product or part of the Product:
 - i. due to the Product being inadequately serviced to manufacturer's recommendations;
 - ii. resulting from environmental conditions including and not limited to dirt, dust, rodents, insects, rust, corrosion, salt built-up, or of in any part of the Product;
 - iii. resulting from excessive use but fair wear and tear is excepted;
 - iv. resulting from installation by an unqualified or uncertified tradesperson;
 - v. resulting from poor or incorrect installation including and not limited to positioning and externally fitted equipment such as plumbing and drainage, cabling, antennae or due to incompatibility of connected equipment;
 - vi. caused by overheating as a result of sitting or positioning of the Product, where there is no provision for adequate ventilation or adequate protection from excessive dust;
 - vii. if the Product has been dismantled, repaired or serviced by any person other than someone authorised by Kleenmaid or its agents or representatives;
 - viii. caused by power surges or spikes, including and not limited to, mains power and telecommunications connections, or to other unspecified sources, incorrect power current, voltage fluctuation, amperage fluctuation, rust or corrosion;
 - ix. if the Product is dropped, collision of the Product with another object, use for which the Product is not designed, damage to the Product caused by your own negligence, accidental or deliberate misuse of the Product by you, theft, abuse, vandalism, flood, fire, earthquake, electrical storms or any other act of God or any war related events; or
 - x. due to the introduction of abnormal heat loads to the Product;
 - b. costs of attendance and testing where no fault or defect covered by the terms of this Kleenmaid Warranty is identified in the Product;
 - c. initial setup and installation of the Product;
 - d. normal maintenance costs and costs incurred through the installation of items listed as requiring periodic replacement;
 - e. Products with removed or altered serial numbers;
 - f. broken or cracked glass other than transport damage to the initial point of delivery;
 - g. consumables such as but not limited to bulbs/globes, seals, filters, batteries and remote controls;
 - h. removal and reinstallation of an internal component not performed by an authorised Kleenmaid agent or representative or authorised service centre;
 - i. cosmetic or structural items; or
 - j. any failures due to interference from or with other products and/or sources.
8. This Kleenmaid Warranty ceases if: -
 - a. the Product ceases to carry the original manufacturer's serial number or is sold at an auction;
 - b. the Product is rented; or
 - c. there is failure to pay monies owing on invoices as a result of non-warranty work being carried out at the request of the end user as per point 16 below.

9. Service under this warranty may be limited by the area in which you live. Service to remote and regional areas may incur additional travel costs which will be payable by you. You will be advised of this at the time you make a claim and Kleenmaid arranges to attend your premises.
10. Neither Kleenmaid nor its representatives provide loan equipment under the terms of this Kleenmaid Warranty.
11. Any unauthorised access to the internal hardware of the Product will void this Kleenmaid Warranty.
12. Repair Notice: Products presented for repair may be replaced by refurbished Products of the same type rather than being repaired. Refurbished parts may be used to repair the Products.
13. Replacement items are "like for like" and is not "new for old" and does not indicate in any way that a faulty Product will be replaced with a new part or unit. "Like for like" may either be a quality checked, refurbished or reconditioned unit of the same or later batch of model/size/specifications
14. The cost of making a claim under this Kleenmaid Warranty is not covered by Kleenmaid, including any costs of transportation or travel expenses between your home and your nearest authorised service agent.
15. Kleenmaid accepts no liability for items that are lost, damaged, or stolen as a result of freight, transport or storage. If you are required to transport the Product to an authorised service centre, you must ensure that it is securely packed and insured.
16. On Public Holidays or other periods when regular business and wholesale operations are temporarily ceased, repairer availability and warranty response times may extend beyond the standard response times due to the unavailability of repairers and parts.
17. For any repair performed on a Product under this Kleenmaid Warranty where no fault can be found, or the item is deemed by Kleenmaid or an authorised agent, to be not faulty under this Kleenmaid Warranty, or the repair or fault is not covered under this Kleenmaid Warranty, a 'No Fault Found' fee is payable by you. Kleenmaid will advise you of this cost and seek your agreement to pay such costs before commencing such repairs.
18. Any repairs or services required that are outside the terms and conditions of this Kleenmaid Warranty can be carried out at your request at your cost (including where the Product has not been installed or set up correctly). Kleenmaid will always advise you of this cost and seek your agreement to pay such costs before commencing such repairs. A credit card may be required prior to the commencement of such services.
19. Extra charges will be payable by the customer should the Product not be readily accessible without special equipment, such as but not limited to cranes and lifts or should the Product be installed in a position that service access is blocked and/or repair work is not possible without uninstalling the Product to gain access.
20. You, the customer, may be entitled to purchase an extended warranty in respect of the Product. Any extended warranty will not be issued by Kleenmaid but by a third party. Any extended warranty services will be provided directly by the third party as principal and not as agent for Kleenmaid, under their extended warranty terms and conditions and not under this Kleenmaid Warranty.
21. To make a claim under this Kleenmaid Warranty, please have your proof of purchase and the serial number of the Product ready and call (02) 9310 1207 during business hours.
22. This Kleenmaid Warranty is given by:
 - Name: Compass Capital Services Pty Ltd ABN 96 138 214 525 trading as Kleenmaid
 - Business address: Level 2, Suite 3, 204 Botany Rd, Alexandria NSW Australia 2015
 - Telephone: (02) 9310 1207
23. Definitions:
 - a. **Australian Consumer Law** means the *Competition and Consumer Act 2010* (Cth).
 - b. **Domestic Use** means use of the Product for personal, domestic or household purposes.
 - c. **Kleenmaid** means Compass Capital Services Pty Ltd ABN 96 138 214 525 trading as Kleenmaid.
 - d. **Mainland Australia** means the following States and Territories of Australia: New South Wales, Victoria, South Australia, Western Australia, Queensland, Tasmania, Northern Territory, Australian Capital Territory.
 - e. **Product** means the appliance sold by Kleenmaid to you as evidenced by the original purchase invoice.
 - f. **Service Agent** means any independent service agent engaged by Kleenmaid to carry out any repair or service under this warranty.
 - g. **Warranty Period** means for domestic use and for Products purchased on or after 1 January 2019 the period of 60 months, otherwise 36 months. For non-domestic use 12 months or such alternative period as may be specified.

UPDATE NOTICE: This Kleenmaid Warranty is current as at 1 December 2022 but is subject to variation from time to time. For the latest version of the Kleenmaid Warranty, please see our website <https://kleenmaid.com.au/warranty/> or phone us on (02) 9310 1207.

This page has been intentionally left blank.

Other products available in the Kleenmaid range of appliances

- | Washing machines
- | Clothes dryers
- | Dishwashers
- | Ovens
- | Cooktops
- | Steam ovens
- | Microwave ovens
- | Built in espresso coffee machines
- | Rangehoods
- | Freestanding ovens
- | Refrigerators & Freezers
- | Beverage Serving Cabinets
- | Water Dispensers
- | Vacuum Cleaners

To register your warranty or make a warranty claim, scan this QR code:



Compass Capital Services Pty Limited
trading as Kleenmaid
ABN 96138214525

Level 2, 204 Botany Road Alexandria
NSW 2015



Register your Kleenmaid
Appliances Warranty
www.kleenmaidwarranty.com.au



Request a Warranty Service
www.kleenmaidwarranty.com.au

E: warranty@kleenmaid.com.au

Please download the current User Manual for this
appliance at www.kleenmaid.com.au

 **kleenmaid**