

# cooking collection

---

Instructions for use and warranty details

To register your warranty or make a warranty claim, scan this QR code:



Built In Microwave Oven  
Model No.: MWG4511

 **kLEENmaid**

Dear Customer,

Thank you and congratulations for choosing Kleenmaid.

Your new appliance has been designed and meticulously tested to ensure that it meets all your culinary requirements, and has been carefully manufactured using top quality materials to give you years of reliable performance.

For best results, carefully read the instructions on how your new appliance is to be installed. Correct installation will avoid delays and unnecessary service call costs.

Once installation is complete, please read this instruction manual carefully and get to know the controls and the features of your new Kleenmaid appliance. These simple instructions will enable you to achieve excellent results from the very first time you use it.

Again, congratulations and thank you for choosing The Best You Can Own.

KLEENMAID

**Before using or installing this appliance please read the complete user manual, including the Safety Warnings. The latest version of this manual is available on our website. (See back cover for details.)**

## **PRECAUTIONS TO AVOID POSSIBLE EXPOSURE TO EXCESSIVE MICROWAVE ENERGY**

- (a) Do not attempt to operate this oven with the door open since this can result in harmful exposure to microwave energy. It is important not to break or tamper with the safety interlocks.
- (b) Do not place any object between the oven front face and the door or allow soil or cleaner residue to accumulate on sealing surfaces.
- (c) **WARNING:** If the door or door seals are damaged, the oven must not be operated until it has been repaired by a competent person.

### **WARNING**

If the apparatus is not maintained in a good state of cleanliness, its surface could become degraded and affect the lifespan of the apparatus and lead to a dangerous situation.

## **Specifications**

|                                |                   |
|--------------------------------|-------------------|
| Model:                         | MWG4511           |
| Rated Voltage:                 | 230-240V~ 50Hz    |
| Rated Input Power(Microwave):  | 1450W             |
| Rated Output Power(Microwave): | 900W              |
| Rated Input Power(Grill):      | 1100W             |
| Oven Capacity (Net/Gross):     | 28L               |
| Turntable Diameter:            | Ø315mm            |
| External Dimensions:           | 595 x 400 x 388mm |
| Net Weight:                    | Approx. 18.5 kg   |

# IMPORTANT SAFETY INSTRUCTIONS WARNING:

To reduce the risk of fire, electric shock, injury to persons or exposure to excessive microwave energy when using your appliance, follow basic precautions including the following:

1. Warning: Liquids and other foods must not be heated in sealed containers since they are liable to explode.
2. Warning: It is hazardous for anyone other than a competent person to carry out any service or repair operation that involves the removal of a cover which gives protection against exposure to microwave energy.
3. Warning: The appliance is not intended for use by persons (including children) with reduced physical, sensory or mental capabilities, or lack of experience and knowledge, unless they have been given supervision or instruction concerning use of the appliance by a person responsible for their safety.
4. Warning: When the appliance is operated in the combination mode, children should only use the oven under adult supervision due to the temperatures generated. (only for grill series)
5. Only use utensils suitable for use in microwave ovens.
6. The oven should be cleaned regularly and any food deposits should be removed.
7. Read and follow the specific: "PRECAUTIONS TO AVOID POSSIBLE EXPOSURE TO EXCESSIVE MICROWAVE ENERGY".
8. When heating food in plastic or paper containers, keep an eye on the oven due to the possibility of ignition.
9. If smoke is observed, switch off or unplug the appliance and keep the door closed in order to stifle any flames.
10. Do not overcook food.
11. Do not use the oven cavity for storage purposes. Do not store items, such as bread, cookies, etc. inside the oven.
12. Remove wire twist-ties and metal handles from paper or plastic containers/bags before placing them in the oven.
13. Install or locate this oven only in accordance with the installation instructions provided.
14. Eggs in the shell and whole hard-boiled eggs should not be heated in microwave ovens since they may explode, even after microwave heating has ended.
15. Use this appliance only for its intended uses as described in manual. Do not use corrosive chemicals or vapors in this appliance. This oven is especially designed to heat. It is not designed for industrial or laboratory use.
16. If the supply cord is damaged, it must be replaced by the manufacturer, its service agent or similarly qualified persons in order to avoid a hazard.
17. Do not store or use this appliance outdoors.
18. Do not use this oven near water, in a wet basement or near a swimming pool.
19. The temperature of accessible surfaces may be high when the appliance is operating. The surfaces are liable to get hot during use. Keep cord away from heated surface, and do not cover any events on the oven.
20. Do not let cord hang over edge of table or counter.
21. Failure to maintain the oven in a clean condition could lead to deterioration of the surface that could adversely affect the life of the appliance and possibly result in a hazardous situation.
22. The contents of feeding bottles and baby food jars shall be stirred or shaken and the temperature checked before consumption, in order to avoid burns.

23. Microwave heating of beverages can result in delayed eruptive boiling, therefore care must be taken when handling the container.
24. Children should be supervised to ensure that they do not play with the appliance.
25. The appliances are not intended to be operated by means of an external timer or separate remote-control system.
26. WARNING: Ensure that the appliance is switched off before replacing the lamp to avoid the possibility of electric shock.
27. Accessible parts may become hot during use. Young children should be kept away.
28. Steam cleaner is not to be used.
29. Do not use harsh abrasive cleaners or sharp metal scrapers to clean the oven door glass since they can scratch the surface, which may result in shattering of the glass.
30. During use the appliance becomes hot. Care should be taken to avoid touching heating elements inside the oven.
31. Only use the temperature probe recommended for this oven.(for ovens provided with a facility to use a temperature-sensing probe.)
32. The rear surface of appliance shall be placed against a wall.
33. DO NOT use this microwave oven when empty as this can be dangerous to the user and damage the microwave oven. Always place food, or liquid in a suitable container, in the microwave oven whilst any microwave function is operating.
34. WARNING: When the appliance is operated in the combination mode, children should only use the oven under adult supervision due to the temperatures generated.
35. The surface of a storage cabinet can get hot.
36. The microwave oven must not be operated behind a closed cabinet door.
37. The microwave oven is intended for heating food and beverages. Drying of food or clothing and heating of warming pads, slippers, sponges, damp cloths and similar items may lead to risk of injury or fire.
38. Warning : Do not hold or carry the appliance by the door handle. The door handle cannot hold the weight of the appliance and may break off.
39. The oven and its hinges and associated parts are designed to support the weight of the oven door only, and any damage to the door or its hinges or associated parts which is caused by excessive weight of any kind being placed onto the oven door will not be covered by warranty. The full cost of any warranty service call regarding damage which is assessed to be the result of excessive weight of any kind being placed onto the oven door will be for the care of the owner.
40. Children should specifically be prevented from climbing or standing on the oven door.
41. The appliance should never be lifted or moved by holding the door handle, and it is recommended that the door be removed before lifting or moving the oven.
42. Note: Occasionally the time-of-day clock in this appliance may lose or gain time. This is due to fluctuations in the mains power supply. Although annoying, is not something you can prevent nor will it affect the other functions of the appliance.

# To Reduce the Risk of Injury to Persons Grounding Installation

## DANGER

### Electric Shock Hazard

Touching some of the internal components can cause serious personal injury or death. Do not disassemble this appliance.

## WARNING

### Electric Shock Hazard

Improper use of the grounding can result in electric shock. Do not plug into an outlet until appliance is properly installed and grounded.

## CLEANING

Be sure to unplug the appliance from the power supply.

1. Clean the inside of the oven after using with a slightly damp cloth.
2. Clean the accessories in the usual way in soapy water.
3. The door frame and seal and neighbouring parts must be cleaned carefully with a damp cloth when they are dirty.

### Three pin plug

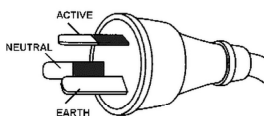

This appliance must be grounded. In the event of an electrical short circuit, grounding reduces the risk of electric shock by providing an escape wire for the electric current. This appliance is equipped with a cord having a grounding wire with a grounding plug. The plug must be plugged into an outlet that is properly installed and grounded.

Consult a qualified electrician or serviceman if the grounding instructions are not completely understood or if doubt exists as to whether the appliance is properly grounded. If it is necessary to use an extension cord, use only a 3-wire extension cord.

1. A short power-supply cord is provided to reduce the risks resulting from becoming entangled in or tripping over a longer cord.
2. If a long cord set or extension cord is used:
  - 1)The marked electrical rating of the cord set or extension cord should be at least as great as the electrical rating of the appliance.
  - 2)The extension cord must be a grounding-type 3-wire cord.
  - 3)The long cord should be arranged so that it will not drape over the counter top or tabletop where it can be pulled on by children or tripped over unintentionally.

# UTENSILS

## CAUTION

### Personal Injury Hazard

It is hazardous for anyone other than a competent person to carry out any service or repair operation that involves the removal of a cover which gives protection against exposure to microwave energy.

See the instructions on "Materials you can use in microwave oven or to be avoided in microwave oven." There may be certain non-metallic utensils that are not safe to use for microwaving. If in doubt, you can test the utensil in question following the procedure below.

### Utensil Test:

1. Fill a microwave-safe container with 1 cup of cold water (250ml) along with the utensil in question.
2. Cook on maximum power for 1 minute.
3. Carefully feel the utensil. If the empty utensil is warm, do not use it for microwave cooking.
4. Do not exceed 1 minute cooking time.

## Materials you can use in microwave oven

| Utensils              | Remarks  |
|-----------------------|--|
| Browning dish         | Follow manufacturer's instructions. The bottom of browning dish must be at least 5mm above the turntable. Incorrect usage may cause the turntable to break.  |
| Dinnerware            | Microwave-safe only. Follow manufacturer's instructions. Do not use cracked or chipped dishes.   |
| Glass jars            | Always remove lid. Use only to heat food until just warm. Most glass jars are not heat resistant and may break during or after cooking.  |
| Glassware             | Heat-resistant oven glassware only. Make sure there is no metallic trim. Do not use cracked or chipped dishes.   |
| Oven cooking bags     | Follow manufacturer's instructions. Do not close with metal twist tie. Make slits in bag to allow steam to escape.   |
| Paper plates and cups | Use for short-term cooking/warming only. Do not leave oven unattended while cooking.   |
| Paper towels          | Use to cover food for reheating and absorbing fat. Use with supervision for a short-term cooking only.   |
| Parchment paper       | Use as a cover to prevent splattering or a wrap for steaming.  |
| Plastic               | Microwave-safe only. Follow the manufacturer's instructions. Should be labeled "Microwave Safe". Some plastic containers soften, as the food inside gets hot. "Boiling bags" and tightly closed plastic bags should be slit, pierced or vented as directed by instructions on the packaging. |
| Plastic wrap          | Microwave-safe only. Use to cover food containers during cooking to retain moisture. Do not allow plastic wrap to touch food.  |
| Thermometers          | Microwave-safe only (meat and candy thermometers).   |
| Wax paper             | Use as a cover to prevent splattering and to retain moisture.  |

## Materials to be avoided in microwave oven

| Utensils                        | Remarks  |
|---------------------------------|--|
| Aluminum tray                   | May cause arcing. Transfer food into microwave-safe dish.                                |
| Food carton with metal handle   | May cause arcing. Transfer food into microwave-safe dish.                                |
| Metal or metal-trimmed utensils | Metal shields the food from microwave energy. Metal trim may cause arcing.               |
| Metal twist ties                | May cause arcing and could cause a fire in the oven.                                     |
| Paper bags                      | May cause a fire in the oven.  |
| Plastic foam                    | Plastic foam may melt or contaminate the liquid inside when exposed to high temperature. |
| Wood                            | Wood will dry out when used in the microwave oven and may split or crack.                |

## SETTING UP YOUR OVEN

### Names of Oven Parts and Accessories

Remove the oven and all materials from the carton and oven cavity. There are oven specific accessories (e.g. screws and brackets) supplied with the oven which should be retained for installation and not discarded with packaging. Your oven also comes with the following accessories:

|                         |   |
|-------------------------|---|
| Glass tray              | 1 |
| Turntable ring assembly | 1 |
| Instruction Manual      | 1 |

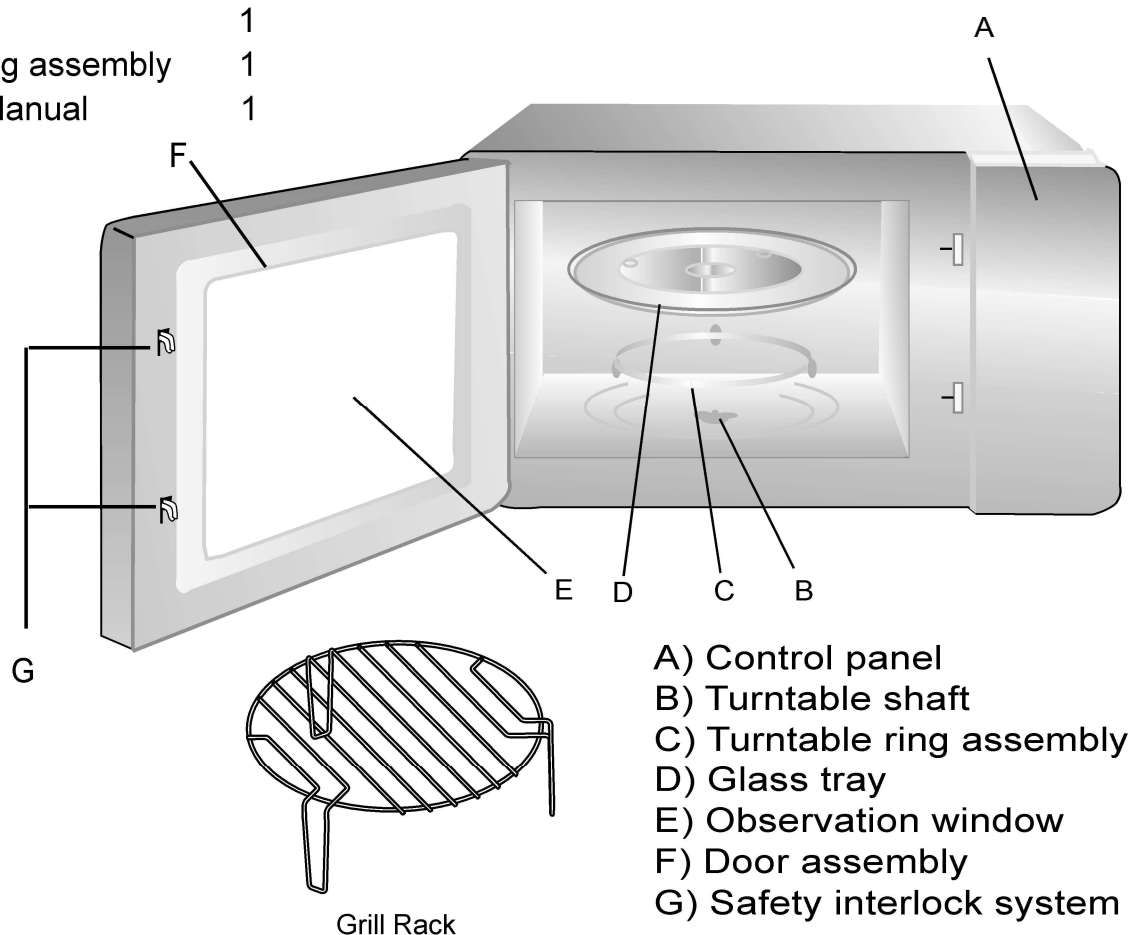

Grill Rack (Only to be used in grill function and to be placed on the glass tray )



## Turntable Installation

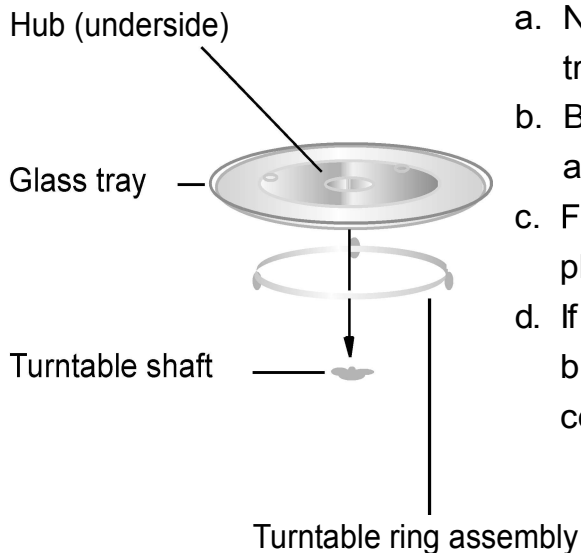

- Never place the glass tray upside down. The glass tray should never be restricted.
- Both glass tray and turntable ring assembly must always be used during cooking.
- Food and containers of food should always be placed on the glass tray for cooking.
- If glass tray or turntable ring assembly cracks or breaks, contact your nearest authorised service centre for assistance.

## Installation and connection

**NOTE: Before making preparations for or commencing installation, the installer should refer to the current online version of the User Manual, which is available on the Kleenmaid website (see back cover for details).**

- This appliance is only intended for domestic use.
- This oven is intended for built-in use only. It is not intended for counter-top use or for use inside a cupboard.
- Please observe the special installation instructions.
- The appliance can be installed in a 60cm wide wall-mounted cupboard (at least 55cm deep and 85cm off the floor).
- The appliance is fitted with a plug and must only be connected to a properly installed and earthed socket.
- The mains voltage must correspond to the voltage specified on the oven rating plate.
- The socket must be installed and connecting cable must only be replaced by a qualified electrician. If the plug is no longer accessible following installation, an all-pole isolating switch must be present on the installation side with a contact gap of at least 3mm.
- Adapters, multi-way strips and extension leads must not be used. Overloading can cause a risk of fire.

The accessible surface may be hot during operation.

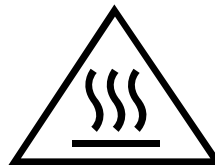

**WARNING: IT MUST BE ENSURED THAT THIS APPLIANCE IS CONNECTED ONLY TO A 230vac +10%/-6% 50Hz MAINS POWER SUPPLY WHICH CONTINUOUSLY COMPLIES WITH THE RELEVANT AUSTRALIAN STANDARD. FAILURE TO DO SO MAY SERIOUSLY DAMAGE THE APPLIANCE AND ANY SUCH DAMAGE IS NOT COVERED BY THE MANUFACTURER'S WARRANTY.**



# Operating Instructions

## 1. Clock Time-of-day Setting

When the microwave oven is plugged in, the LED will display "0:00", buzzer will beep once.

1) Press " **Clock/ Kitchen Timer** " once to select clock function & the hour digits will flash.

---

2) Turn "  " to adjust the hour digits, the input hour should be within the range 0--23.

---

3) Press " **Clock/ Kitchen Timer** " & the minute digits will flash.

---

4) Turn "  " to adjust the minute digits, the input minute should be within the range 0-59.



---

5) Press " **Clock/ Kitchen Timer** " to finish time setting. ":" will flash, and the time will display.

Note: 1) If the clock has not been set, it will not display when the oven is plugged in.

2) During the process of time setting, if you press " **Stop/Clear** ", the oven will go back to the previous state automatically.

## 2. Microwave Cooking

Press " **Micro.Grill/Combi.** " the LED will display "P100". Press " **Micro.Grill/Combi.** " 4 times or turn "  " to choose the power you want, and "P100", "P80" "P50", "P30" or "P10" will display for each added press. Then press " **Start/+30Sec./Confirm** " to confirm, then turn "  " to set cooking time within 0:05-95:00. Press " **Start/+30Sec./Confirm** " again to start cooking.

Example: If you want to use 80% microwave power to cook for 20 minutes, you should operate the oven as follows.

1) Press " **Micro.Grill/Combi.** " once, the screen display "P100".

---

2) Press " **Micro.Grill/Combi.** " once again or turn "  " to choose 80% microwave power.

---

3) Press " **Start/+30Sec./Confirm** " to confirm, and the screen displays "P 80".

---

4) Turn "  " to adjust the cooking time until the oven displays "20:00".

---

5) Press " **Start/+30Sec./Confirm** " to start cooking .

Note: the step quantities for setting the cooking time are as follow:

|             |   |            |
|-------------|---|------------|
| 0---1 min   | : | 5 seconds  |
| 1---5 min   | : | 10 seconds |
| 5---10 min  | : | 30 seconds |
| 10---30 min | : | 1 minute   |
| 30---95 min | : | 5 minutes  |



## NOTE: Condensation During Microwave Cooking

Because microwave-only cooking heats the food and not the oven, moisture released as steam during cooking may form condensation on the cooler walls and doors of the oven. This is normal, and after cooking has completed, any remaining condensation may be removed with a soft dry cloth.

To reduce the amount of moisture released from the food during microwave-only cooking, it may be covered with microwave oven compatible plastic food wrap. Be careful when removing the plastic wrap because the moisture vapours released will be very hot.

Plastic food wrap should not be used during grill or microwave combination cooking.

### 3. Grill or Combi Cooking

Press " **Micro.Grill/Combi.** " the LED will display "P100", and press " **Micro.Grill/Combi.** " 4 times or turn the "  " to choose the power you want, and "G", "C-1" or "C-2" will display for each added press. Then press " **Start/+30Sec./Confirm** " to confirm, and turn "  " to set cooking time from 0:05 to 95:00.

Press " **Start/+30Sec./Confirm** " again to start cooking.

Example: If you want to use 55% microwave power and 45% grill power (C-1) to cook for 10 minutes, you should operate the oven as follows.

1) Press " **Micro.Grill/Combi.** " once, the screen display "P100".

---

2) Press " **Micro.Grill/Combi.** " once again or turn "  " to choose Combi 1 mode.

---

3) Press " **Start/+30Sec./Confirm** " to confirm, and the screen displays "C-1".

---

4) Turn "  " to adjust the cooking time until the oven displays "10:00".

---

5) Press " **Start/+30Sec./Confirm** " to start cooking .

Note: After half the grilling time has elapsed, the oven beeps twice; this is normal.

After the beeps, for a better result you should turn the food over, close the door, then press " **Start/+30Sec./Confirm** " to continue cooking.

If there is no intervention after the beeps, the oven will continue cooking.

### 4. Quick Start

1) In waiting state, Press " **Start/+30Sec./Confirm** " to start cooking with 100% power, and each added press will increase cooking time by 30 seconds up to 95 minutes.

2) In microwave, grill, combination cooking or time defrost mode, each press of " **Start/+30Sec./Confirm** " adds 30 seconds of cooking time.

3) In waiting state, turn "  " left to set cooking time with 100% microwave power, then press " **Start/+30Sec./Confirm** " to start cooking.

## 5. Defrost By Weight

1) Press " **W.T./Time Defrost** " once, and the oven will display "dEF1".

---

2) Turn "  " to select the weight of food from 100 to 2000 g.

---

3) Press " **Start/+30Sec./Confirm** " to start defrosting.

## 6. Defrost By Time

1) Press " **W.T./Time Defrost** " twice, and the oven will display "dEF2".

---

2) Turn "  " to select the defrost time. The maximum defrosting time is 95 minutes.

---

3) Press " **Start/+30Sec./Confirm** " to start defrosting. The microwave power is P30, and it cannot be changed in this mode.

## 7. Kitchen Countdown Timer

(1) Press " **Clock/ Kitchen Timer** " twice and 00:00 will be displayed.

(2) Turn "  " to enter the desired period (maximum 95 minutes).

(3) Press " **Start/+30Sec./Confirm** " to confirm setting and start the countdown timer.

(4) When the kitchen timer expires, clock indicator will go off & buzzer will beep 5 times.

If the time-of-day clock has previously been set, the current time will then be displayed.

## 8. Auto Menu

1) Turn "  " right to choose the menu, and "A-1" to "A-8" will display, which means auto reheat, vegetables, fish, meat, pasta, potato, pizza and soup.

---

2) Press " **Start/+30Sec./Confirm** " to confirm.

---

3) Turn "  " to choose the default weight (see the menu chart on the next page).

---

4) Press " **Start/+30Sec./Confirm** " to start cooking.

Example: If you want to use "Auto Menu" to cook 350g of fish.

1) Turn "  " right until "A-3" is displayed.

---

2) Press " **Start/+30Sec./Confirm** " to confirm.

---

3) Turn "  " to select 350g of fish i.e. "350" is displayed.

---

4) Press " **Start/+30Sec./Confirm** " to start cooking.

Automatic menu settings:

| Menu               | Weight                   | Display |
|--------------------|--------------------------|---------|
| A-1<br>Auto Reheat | 200 g                    | 200 g   |
|                    | 400 g                    | 400 g   |
|                    | 600 g                    | 600 g   |
| A-2<br>Vegetables  | 200 g                    | 200 g   |
|                    | 300 g                    | 300 g   |
|                    | 400 g                    | 400 g   |
| A-3<br>Fish        | 250 g                    | 250 g   |
|                    | 350 g                    | 350 g   |
|                    | 450 g                    | 450 g   |
| A-4<br>Meat        | 250 g                    | 250 g   |
|                    | 350 g                    | 350 g   |
|                    | 450 g                    | 450 g   |
| A-5<br>Pasta       | 50 g (with 450ml water)  | 50 g    |
|                    | 100 g (with 800ml water) | 100 g   |
| A-6<br>Potato      | 200 g                    | 200 g   |
|                    | 400 g                    | 400 g   |
|                    | 600 g                    | 600 g   |
| A-7<br>Pizza       | 200 g                    | 200 g   |
|                    | 400 g                    | 400 g   |
| A-8<br>Soup        | 200 ml                   | 200 ml  |
|                    | 400 ml                   | 400 ml  |

Microwave and combi power settings:

| Number of steps | Function  | Symbol shown on the display | Microwave power | Grill power |
|-----------------|-----------|-----------------------------|-----------------|-------------|
| 1               | Microwave | P100                        | 100%            | -           |
| 2               | Microwave | P80                         | 80%             | -           |
| 3               | Microwave | P50                         | 50%             | -           |
| 4               | Microwave | P30                         | 30%             | -           |
| 5               | Microwave | P10                         | 10%             | -           |
| 6               | Grill     | G                           | 0%              | 100%        |
| 7               | Combi     | C - 1                       | 55%             | 45%         |
| 8               | Combi     | C - 2                       | 36%             | 64%         |

## 9. Multi-stage Cooking

A maximum of 2 stages can be set for cooking. In multi-stage cooking, if one stage is defrosting, then defrosting shall be the first stage.

Example: If you want to defrost food for 5 minutes and then cook with 80% microwave power for 7 minutes, operate the oven as follows:

- 1) Press " **W.T./Time Defrost** " twice, and the oven will display "dEF2".

---
- 2) Turn "  " to select the defrost time of "5:00" on the display.

---
- 3) Press " **Micro.Grill/Combi.** " once, the screen displays "P100".

---
- 4) Press " **Micro.Grill/Combi.** " once again or turn "  " to choose 80% microwave power.

---
- 5) Press " **Start/+30Sec./Confirm** " to confirm, and the screen displays "P 80".

---
- 6) Turn "  " to adjust the cooking time until "7:00" is displayed.

---
- 7) Press " **Start/+30Sec./Confirm** " to start cooking, and buzzer will sound once for the first stage, and the defrost timer counts down; buzzer will sound once again when entering the second stage. When cooking completely finishes, the buzzer sounds five times.

## 10. Enquiry Function

- (1) While microwave, grill or combination cooking, press " **Micro.Grill/Combi.** " and the current power level will be displayed for 3 seconds, after which the oven will switch back to its previous state;
- (2) In cooking state, press " **Clock/ Kitchen Timer** " to display the time of day for 3 seconds.

## 11. Child Lock Function

Lock: In waiting state, press " **Stop/Clear** " for 3 seconds, and there will be a long beep indicating the child lock is on. The current time will display if the time-of-day has been set, otherwise " **[-: -:]** " will be displayed.

Unlock: In locked state, press " **Stop/Clear** " for 3 seconds, and there will be a long "beep" indicating that the child lock has switched off.

## Trouble shooting

| <b>NORMAL OPERATION</b>                               |   |
|---|---|
| Microwave oven operation interferes with TV reception | Radio and TV reception may be affected when the microwave oven is operating, as is the case with other small electrical appliances like vacuum cleaners and food mixers. This is normal.                    |
| Dim oven light  | In low power microwave cooking, oven light may become dim. It is normal.  |
| Steam accumulating on door, hot air out of vents      | Steam escapes from heated food. Most will escape through oven vents but some will condense on the cool door. This is normal.  |
| Oven started accidentally with no food in.            | DO NOT use this microwave oven when empty as this can be dangerous to the user and damage the microwave oven. Always place food, or liquid in a suitable container, in the microwave oven whilst operating. |

| <b>Trouble</b>         | <b>Possible Cause</b>                      | <b>Remedy</b>  |
|------------------------|--|--|
| Oven cannot be started | (1) Power cord not plugged in tightly.     | Unplug. Then plug again after 10 seconds.                                  |
|                        | (2) Fuse blowing or circuit breaker works. | Replace fuse or reset circuit breaker (repaired by professional personnel) |
|                        | (3) Trouble with outlet.                   | Test outlet with other electrical appliances.                              |
| Oven does not heat.    | (4) Door not closed well.                  | Close door well.   |

If the appliance fails to operate correctly during the warranty period please visit our website to request a warranty service (see back cover of this manual for details). When booking a service please provide your Model No: MWG4511, and the individual Serial Number of your appliance. This is found on the label inside the front of the oven, visible when the oven door is open.



According to Waste of Electrical and Electronic Equipment (WEEE) directive, WEEE should be separately collected and treated. If at any time in future you need to dispose of this product please do NOT dispose of this product with household waste. Please send this product to WEEE collecting points where available.

# Installation Instructions

NOTE: Before making preparations for or commencing installation, the installer should refer to the current online version of the User Manual, which is available on the Kleenmaid website (see back cover for details).

## Please note

### Electrical connection

The oven is fitted with a plug and must only be connected to a properly installed earthed socket. The socket must only be installed and the connecting cable must only be replaced by a qualified electrician, and in accordance with the appropriate regulations. If the plug is no longer accessible following installation, an all-pole isolating switch must be present on the installation side with a contact gap of at least 3 mm.

The fitted cabinet must not have a back wall behind the appliance.

Minimum installation height: 85 cm.

Do not cover ventilation slots and suction holes.

### Note:

Do not trap or bend the power cable.

**Note:** This appliance should be connected to the mains power supply via the supplied plug & cord, and a standard 10A GPO.

## A. Built-in furniture

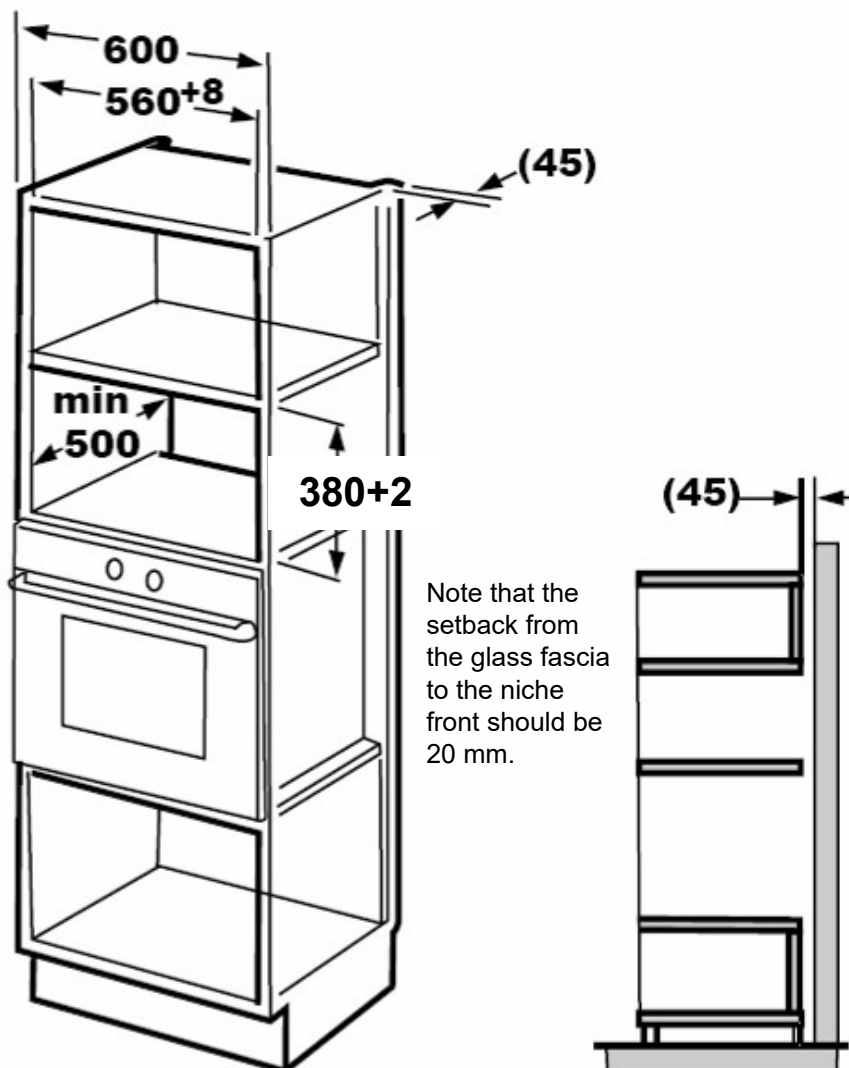



## B.Prepare the cabinet

1. Read the instruction on the BOTTOM CABINET TEMPLATE , put the template on the bottom plane of cabinet.

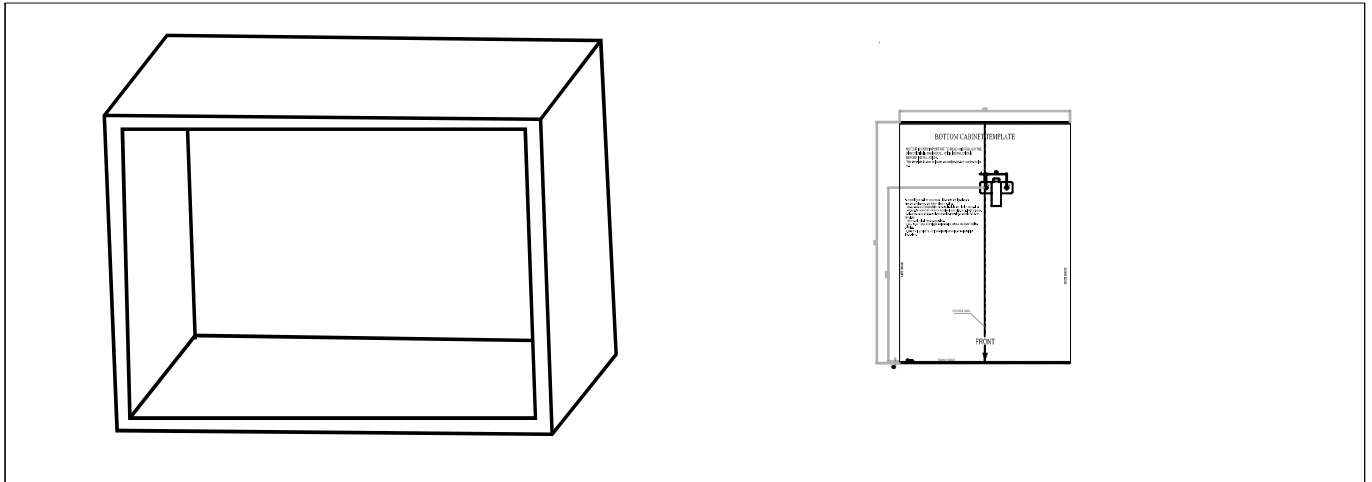

2. Make the marks on the bottom plane of cabinet according to marks "a" on the template

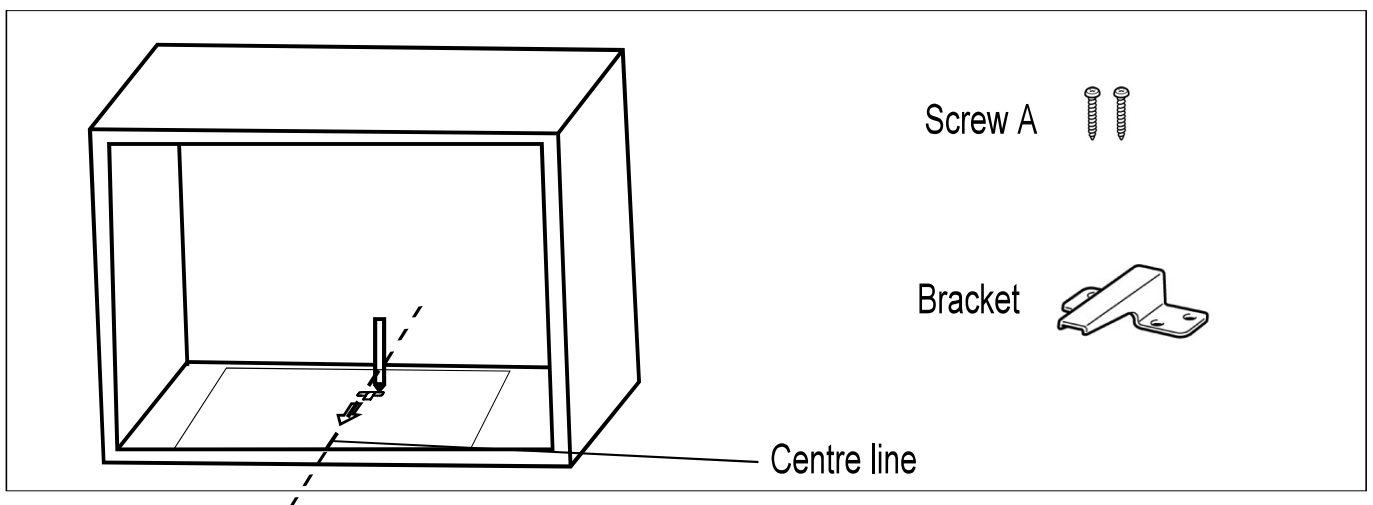

3. Remove the bottom cabinet template and fix the bracket with screws A.

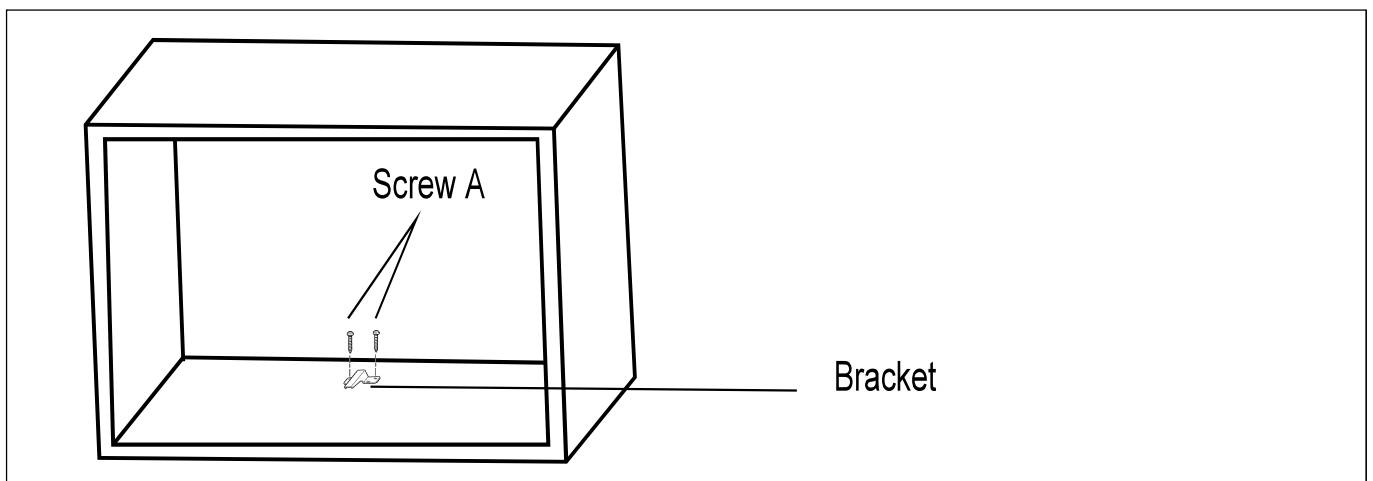

# KLEENMAID WARRANTY

## TERMS AND CONDITIONS

1. Compass Capital Services Pty Ltd ABN 96 138 214 525 trading as Kleenmaid will provide parts and labour to you the customer as set out herein.
2. Kleenmaid may engage a Service Agent to provide service under this warranty.
3. Kleenmaid's Products come with guarantees that cannot be excluded under the Australian Consumer Law. You are entitled to a replacement or refund for a major failure and for compensation for any other reasonably foreseeable loss or damage. You are also entitled to have the goods repaired or replaced if the goods fail to be of acceptable quality and the failure does not amount to a major failure.
4. The benefits given to you under this Kleenmaid Warranty are in addition to other rights and remedies to which you may be entitled under the Australian Consumer Law in relation to the Product to which this Kleenmaid Warranty relates. Subject to the conditions below, the Product is warranted by Kleenmaid and/or its agents to be free from defects in materials and workmanship for the Warranty Period for normal Domestic Use.
5. Product Identification: -
  - a. Kleenmaid reserves the right to reject claims for any services or work where you cannot produce for verification the serial number and a proof of purchase for the Product (including but not limited to the original invoice).
  - b. this Kleenmaid Warranty will be voided if the serial number for the Product cannot be verified. This is not intended to exclude, restrict or modify any right or remedy to which you may otherwise be entitled under the consumer guarantee provisions of the Australian Consumer Law.
  - c. in the event that a request for repair is made against this Kleenmaid Warranty where the serial number for the Product cannot be verified or you cannot produce for verification a proof of purchase for the Product (including but not limited to the original invoice), the repairer will not carry out any repairs on the Product and you will be charged a service call-out fee.
6. What is covered by this Kleenmaid Warranty: -
  - a. the Product is covered for faulty workmanship or parts that have failed under normal Domestic Use.
  - b. Kleenmaid and/or its agents will determine by objective testing if there are any defects in the Product and/or faulty workmanship.
  - c. this Kleenmaid Warranty is only applicable if repairs on Products are carried out within Mainland Australia.
  - d. this Kleenmaid Warranty: -
    - i. covers a Product purchased as new, manufactured for use in Mainland Australia;
    - ii. commences from the date of delivery of the Product;
    - iii. provides for the labour and replacement parts necessary to maintain the Product in good operating condition as specified in this Kleenmaid Warranty, however, if repair is needed because of Product failure during normal Domestic Use, Kleenmaid has the option to repair or replace the defective Product or part of the Product with a product or part of like kind and quality. A replacement part may be new or reconditioned of like kind and quality and may cost less than the original Product purchased and no charges or refunds will be made based on the replacement product or part cost difference; and
    - iv. is only applicable when the Product is used and operated in accordance with the Manufacturer's instructions.
7. What is not Covered by this Kleenmaid Warranty (excluded):-
  - a. any damage or failure to or of the Product or part of the Product:
    - i. due to the Product being inadequately serviced to manufacturer's recommendations;
    - ii. resulting from environmental conditions including and not limited to dirt, dust, rodents, insects, rust, corrosion, salt built-up, or of in any part of the Product;
    - iii. resulting from excessive use but fair wear and tear is excepted;
    - iv. resulting from installation by an unqualified or uncertified tradesperson;
    - v. resulting from poor or incorrect installation including and not limited to positioning and externally fitted equipment such as plumbing and drainage, cabling, antennae or due to incompatibility of connected equipment;
    - vi. caused by overheating as a result of sitting or positioning of the Product, where there is no provision for adequate ventilation or adequate protection from excessive dust;
    - vii. if the Product has been dismantled, repaired or serviced by any person other than someone authorised by Kleenmaid or its agents or representatives;
    - viii. caused by power surges or spikes, including and not limited to, mains power and telecommunications connections, or to other unspecified sources, incorrect power current, voltage fluctuation, amperage fluctuation, rust or corrosion;
    - ix. if the Product is dropped, collision of the Product with another object, use for which the Product is not designed, damage to the Product caused by your own negligence, accidental or deliberate misuse of the Product by you, theft, abuse, vandalism, flood, fire, earthquake, electrical storms or any other act of God or any war related events; or
    - x. due to the introduction of abnormal heat loads to the Product;
  - b. costs of attendance and testing where no fault or defect covered by the terms of this Kleenmaid Warranty is identified in the Product;
  - c. initial setup and installation of the Product;
  - d. normal maintenance costs and costs incurred through the installation of items listed as requiring periodic replacement;
  - e. Products with removed or altered serial numbers;
  - f. broken or cracked glass other than transport damage to the initial point of delivery;
  - g. consumables such as but not limited to bulbs/globes, seals, filters, batteries and remote controls;
  - h. removal and reinstallation of an internal component not performed by an authorised Kleenmaid agent or representative or authorised service centre;
  - i. cosmetic or structural items; or
  - j. any failures due to interference from or with other products and/or sources.
8. This Kleenmaid Warranty ceases if: -
  - a. the Product ceases to carry the original manufacturer's serial number or is sold at an auction;
  - b. the Product is rented; or
  - c. there is failure to pay monies owing on invoices as a result of non-warranty work being carried out at the request of the end user as per point 16 below.

9. Service under this warranty may be limited by the area in which you live. Service to remote and regional areas may incur additional travel costs which will be payable by you. You will be advised of this at the time you make a claim and Kleenmaid arranges to attend your premises.
10. Neither Kleenmaid nor its representatives provide loan equipment under the terms of this Kleenmaid Warranty.
11. Any unauthorised access to the internal hardware of the Product will void this Kleenmaid Warranty.
12. Repair Notice: Products presented for repair may be replaced by refurbished Products of the same type rather than being repaired. Refurbished parts may be used to repair the Products.
13. Replacement items are "like for like" and is not "new for old" and does not indicate in any way that a faulty Product will be replaced with a new part or unit. "Like for like" may either be a quality checked, refurbished or reconditioned unit of the same or later batch of model/size/specifications
14. The cost of making a claim under this Kleenmaid Warranty is not covered by Kleenmaid, including any costs of transportation or travel expenses between your home and your nearest authorised service agent.
15. Kleenmaid accepts no liability for items that are lost, damaged, or stolen as a result of freight, transport or storage. If you are required to transport the Product to an authorised service centre, you must ensure that it is securely packed and insured.
16. On Public Holidays or other periods when regular business and wholesale operations are temporarily ceased, repairer availability and warranty response times may extend beyond the standard response times due to the unavailability of repairers and parts.
17. For any repair performed on a Product under this Kleenmaid Warranty where no fault can be found, or the item is deemed by Kleenmaid or an authorised agent, to be not faulty under this Kleenmaid Warranty, or the repair or fault is not covered under this Kleenmaid Warranty, a 'No Fault Found' fee is payable by you. Kleenmaid will advise you of this cost and seek your agreement to pay such costs before commencing such repairs.
18. Any repairs or services required that are outside the terms and conditions of this Kleenmaid Warranty can be carried out at your request at your cost (including where the Product has not been installed or set up correctly). Kleenmaid will always advise you of this cost and seek your agreement to pay such costs before commencing such repairs. A credit card may be required prior to the commencement of such services.
19. Extra charges will be payable by the customer should the Product not be readily accessible without special equipment, such as but not limited to cranes and lifts or should the Product be installed in a position that service access is blocked and/or repair work is not possible without uninstalling the Product to gain access.
20. You, the customer, may be entitled to purchase an extended warranty in respect of the Product. Any extended warranty will not be issued by Kleenmaid but by a third party. Any extended warranty services will be provided directly by the third party as principal and not as agent for Kleenmaid, under their extended warranty terms and conditions and not under this Kleenmaid Warranty.
21. To make a claim under this Kleenmaid Warranty, please have your proof of purchase and the serial number of the Product ready and call (02) 9310 1207 during business hours.
22. This Kleenmaid Warranty is given by:  
 Name: Compass Capital Services Pty Ltd ABN 96 138 214 525 trading as Kleenmaid  
 Business address: Level 2, Suite 3, 204 Botany Rd, Alexandria NSW Australia 2015  
 Telephone: (02) 9310 1207
23. Definitions:
  - a. **Australian Consumer Law** means the *Competition and Consumer Act 2010* (Cth).
  - b. **Domestic Use** means use of the Product for personal, domestic or household purposes.
  - c. **Kleenmaid** means Compass Capital Services Pty Ltd ABN 96 138 214 525 trading as Kleenmaid.
  - d. **Mainland Australia** means the following States and Territories of Australia: New South Wales, Victoria, South Australia, Western Australia, Queensland, Tasmania, Northern Territory, Australian Capital Territory.
  - e. **Product** means the appliance sold by Kleenmaid to you as evidenced by the original purchase invoice.
  - f. **Service Agent** means any independent service agent engaged by Kleenmaid to carry out any repair or service under this warranty.
  - g. **Warranty Period** means for domestic use and for Products purchased on or after 1 January 2019 the period of 60 months, otherwise 36 months. For non-domestic use 12 months or such alternative period as may be specified.

**UPDATE NOTICE:** This Kleenmaid Warranty is current as at 1 December 2022 but is subject to variation from time to time. For the latest version of the Kleenmaid Warranty, please see our website <https://kleenmaid.com.au/warranty/> or phone us on (02) 9310 1207.

## Other products available in the Kleenmaid range of appliances

---

- | Washing machines
- | Clothes dryers
- | Dishwashers
- | Ovens
- | Cooktops
- | Steam ovens
- | Microwave ovens
- | Built in espresso coffee machines
- | Rangehoods
- | Freestanding ovens
- | Refrigerators & Freezers
- | Beverage Serving Cabinets
- | Water Dispensers
- | Vacuum Cleaners

To register your warranty or make a warranty claim, scan this QR code:



Compass Capital Services Pty Limited  
trading as Kleenmaid  
ABN 96138214525

Level 2, 204 Botany Road Alexandria  
NSW 2015



Register your Kleenmaid  
Appliances Warranty  
[www.kleenmaidwarranty.com.au](http://www.kleenmaidwarranty.com.au)



Request a Warranty Service  
[www.kleenmaidwarranty.com.au](http://www.kleenmaidwarranty.com.au)

E: [warranty@kleenmaid.com.au](mailto:warranty@kleenmaid.com.au)  
Please download the current User Manual for this  
appliance at [www.kleenmaid.com.au](http://www.kleenmaid.com.au)

 **kleenmaid**