

KBTAU900XE

Product family	Hood
Hood Type	Decorative wall hood
Design	T flat
Extraction	Extraction
Electronic control	Yes
Material	Stainless steel
Type of steel	Brushed
EAN code	8017709287849
Hood width	90 cm





Aesthetics

Aesthetic Colour	Universale Stainless steel	Finishing Logo	Satin Silk screen
------------------	-------------------------------	----------------	----------------------



Controls

Control setting	Electronic buttons
-----------------	--------------------

Programs / Functions

No. of speeds	3
Intensive speed	
24h air filter function	
Time-setting options	

Technical Features

  	No. of lights	2	Anti-grease filters	Aluminium
	Light type	LED	Filter replacement indicator	Yes
	Light Power	1,3 W	Vent outlet	150 mm
	Free outlet maximum capacity	730 m ³ /h	Minimum distance from GAS hob	650 mm
	Motor power	230 W		

No. of filters	3	Minimum distance from ELECTRIC hob	500 mm
		Non return valve	Yes

	Extraction rate IEC 61591 [m³/h]	Noise level IEC 60704-2-13 [dB(A)]
Speed 1	265	47
Speed 2	360	55
Speed 3	480	62
Intensive speed	713	72

Accessories Included

Tube reduction	Yes
-----------------------	------------

Performance / Energy Label





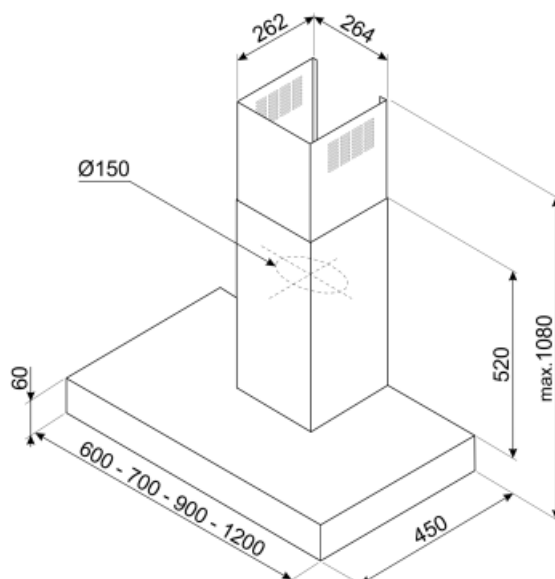

Annual Efficiency Consumption (AEHood)	54 kWh/a
---	-----------------

Electrical Connection

Plug	(I) Australia	Frequency (Hz)	50-60 Hz
Voltage	220-240 V	Power supply cable length	1500 mm



Symbols glossary (TT)

- | | | | |
|--|--|---|--|
|  | <p>24h: When selected this function refreshes the air for c. 10 minutes every hour over a 24 hour period, at minimum speed and an imperceptible noise level.</p> |  | <p>Filters: Model has filters to help remove grease from the steam emanating from the pans during cooking.</p> |
|  | <p>Switch off automatically: A special setting, to run after the end of cooking for a pre-set time and then switch off automatically.</p> |  | <p>Warning light(s): to advise when filters need changing.</p> |
|  | <p>Lights: All cooker hoods feature lights to illuminate the cooking area or add to the ambience of the kitchen.</p> |  | <p>Intensive/turbo setting: when extra fast extraction is required.</p> |