

KBT1200XE

Product family	Hood
Hood Type	Decorative wall hood
Design	T flat
Extraction	Extraction
Electronic control	Yes
Material	Stainless steel
Type of steel	Brushed
EAN code	8017709286637
Hood width	120 cm





Aesthetics

Aesthetic Colour	Universale Stainless steel	Finishing Logo	Satin Silk screen
------------------	-------------------------------	----------------	----------------------



Controls

Control setting	Electronic buttons
-----------------	--------------------

Programme / Functions

No. of speeds	3
Intensive speed	
24h air filter function	
Time-setting options	

Technical Features

  	No. of lights	2	Anti-grease filters	Aluminium
	Light type	LED	Filter replacement indicator	Yes
	Light Power	1,3 W	Vent outlet	150 mm
	Light color temperature scale (°K)	3000 °K	Minimum distance from GAS hob	650 mm

Free outlet maximum capacity	610 m ³ /h	Minimum distance from ELECTRIC hob	650 mm
Motor power	230 W	Non return valve	Yes
No. of filters	4		

	Extraction rate IEC 61591 [m ³ /h]	Noise level IEC 60704-2-13 [dB(A)]
Speed 1	251	48
Speed 2	345	56
Speed 3	454	62
Intensive speed	690	72

Accessories Included

Tube reduction	Yes
-----------------------	-----

Performance / Energy Label

A

Annual Efficiency Consumption (AEC_{hood})	55 kWh/a	Airborne acoustical A-weighted sound Power Emission at maximum speed (SPE_{max})	61 dB(A)
Energy efficiency class (EEC)	A	Airbourne acoustical A-weighted sound power emission at boost speed (SPE_{boost})	71 dB(A)
Fluid Dynamic Efficiency (FDE)	30,2	Power consumption in stand-by mode (Ps)	0,23 W
Fluid Dynamic Efficiency class (FDEC)	A	Time increase factor (F)	0,9
Lighting Efficiency (LE)	58,8 lux/W	Energy Efficiency Index	52,1
Lighting Efficiency Class (LEC)	A	Measured air flow rate at best efficiency point (Q_{bep})	387 m ³ /h
Grease Filtering Efficiency (GFE)	79,6 %	Measured air pressure at best efficiency point (P_{bep})	452 Pa
Grease Filtering Efficiency Class (GFEC)	C	Measured electric power input at best efficiency point (W_{bep})	161 W
Air flow at mininum speed (Q_{min})	251 m ³ /h	Nominal Power consumption of the light system (WL)	3 W
Air flow at maximum speed (Q_{max})	454 m ³ /h	Average illumination of the light on the cooking surface (E_{middle})	153 lux
Air flow at boost speed (Q_{boost})	690 m ³ /h	Sound power level at highest setting (L_{wa})	72 dB(A)
Airbourne acouistical A-weighted sound Power Emission at minimum speed (SPE_{min})	47 dB(A)		

Electrical Connection

Electrical connection rating 230 W
Voltage 220-240 V

Frequency (Hz) 50-60 Hz
Power supply cable length 1500 mm

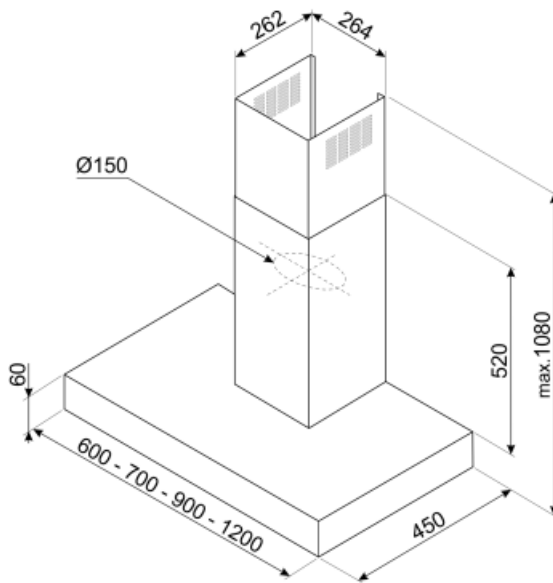

Not included accessories

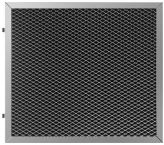

KITFCKBT

1 pcs di filtro a carboni attivi per i modelli di cappe KBT* / KBCT*

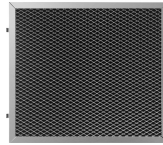

KITFCKBTR







1 pcs of Charcoal filter Regenerable* suitable for all the KBT/KBCT models.
* It can be washed in the dishwasher up to 12 times and dry in the oven at max 90° for 60 min. dimension 237,5(H)x245x10 mm



KITCEKBT

Chimney extension, dimensions 261,5 * 260 * 830 mm suitable for T-shape hood KBT* & KBCT*, max hight 1380 mm Stainless Steel

Symbols glossary (TT)

- | | | | |
|--|---|---|--|
|  | 24h: When selected this function refreshes the air for c. 10 minutes every hour over a 24 hour period, at minimum speed and an imperceptible noise level. |  | Filters: Model has filters to help remove grease from the steam emanating from the pans during cooking. |
|  | A: Product drying performance, measured from A+++ to D / G depending on the product family |  | Switch off automatically: A special setting, to run after the end of cooking for a pre-set time and then switch off automatically. |
|  | Warning light(s): to advise when filters need changing. |  | Lights: All cooker hoods feature lights to illuminate the cooking area or add to the ambience of the kitchen. |
|  | Intensive/turbo setting: when extra fast extraction is required. | | |