

cooking collection

Instructions for use and warranty details

To register your warranty or make a warranty claim, scan this QR code:



Induction Cooktop & Integrated
Air Extraction System

Model No.: ICTFX9020EX (Extractor)
and ICTFX9020HB (Cooktop)

 **kLEENmaid**

Dear Customer,

Thank you and congratulations for choosing Kleenmaid.

Your new appliance has been designed and meticulously tested to ensure that it meets all your culinary requirements, and has been carefully manufactured using top quality materials to give you years of reliable performance.

For best results, carefully read the instructions on how your new appliance is to be installed. Correct installation will avoid delays and unnecessary service call costs.

Once installation is complete, please read this instruction manual carefully and get to know the controls and the features of your new Kleenmaid appliance. These simple instructions will enable you to achieve excellent results from the very first time you use it.

Again, congratulations and thank you for choosing The Best You Can Own.

KLEENMAID

CONTENTS

| | |
|---|----|
| Safety Warnings | 4 |
| Overview of Induction Cooktop and Integrated Air Extraction System | 8 |
| Induction Cooking | 8 |
| Using the Extraction System..... | 11 |
| Using the Cooktop | 12 |
| Cooking Guidelines | 17 |
| Care and Cleaning | 19 |
| Filter Maintenance and Replacement | 20 |
| Installation | 21 |
| Component Descriptions | 25 |
| Connecting the Cooktop to the Mains Power Supply..... | 29 |
| Electrical Diagram..... | 30 |
| Technical Specifications | 31 |
| Hints and Tips..... | 32 |
| Error Codes and Troubleshooting | 33 |
| Warranty | 34 |

Safety Warnings

Your safety is important to us. Please read this information before using your cooktop and make this User Manual available to your installer. A current version of the manual is available on the Kleenmaid website. (See back cover for details.)

Important Safety Instructions for Installation

- Read these instructions carefully before installing or using this appliance.
- No combustible material or products should be placed on this appliance at any time.
- Please make this information available to the person responsible for installing the appliance as it could reduce your installation costs.
- In order to avoid a hazard, this appliance must be installed according to these instructions for installation.
- This appliance is to be properly installed and earthed only by a suitably qualified person.
- This appliance should be connected to a circuit which incorporates an isolating switch providing full disconnection from the power supply.
- Failure to install the appliance correctly could invalidate any warranty or liability claims.
- Take care - panel edges may be sharp.
- The air from the Air Extraction System must not be discharged into a flue that is used for exhausting fumes from appliances burning gas or other fuels. Regulations concerning the discharge of air must be fulfilled.
- Ensure there is a minimum vertical clearance of 8mm, from the bottom of the cooling fan grilles under the cooktop assembly, to any other object.

Electrical Shock Hazard

- Disconnect the appliance from the mains electricity supply before carrying out any work or maintenance on it.
- Connection to a good earth wiring system is essential and mandatory.
- Alterations to the domestic wiring system must only be made by a qualified electrician.
- Failure to follow this advice may result in electrical shock or death.

Important Safety Instructions for Operation and Maintenance

Electrical Shock Hazard

- Do not cook on a broken or cracked cooktop. If the cooktop surface should break or crack, switch the appliance off immediately at the mains power supply (wall switch) and contact a qualified technician.
- Switch the cooktop off at the wall before cleaning or maintenance.
- Failure to follow this advice may result in electrical shock or death.

Health Hazard

- This appliance complies with electromagnetic safety standards. However, persons with cardiac pacemakers or other electrical implants (such as insulin pumps) must consult with their doctor or implant manufacturer before using this appliance to make sure that their implants will not be affected by the electromagnetic field. Failure to follow this advice may result in death.

Hot Surface Hazard

- During use, accessible parts of this appliance will become hot enough to cause burns.
- Do not let your body, clothing or any item other than suitable cookware contact the Induction glass until the surface is cool.
- Metallic objects such as knives, forks, spoons and lids should not be placed on the surface since they can get hot.
- Keep children away.
- Handles of saucepans may be hot to touch. Check that saucepan handles do not overhang other cooking zones. Keep handles out of reach of children.
- Failure to follow this advice could result in burns and scalds.

Cut Hazard

- The razor-sharp blade of a cooktop scraper which may be used for cleaning is exposed when the safety cover is retracted. Use with extreme care and always store safely and out of reach of children.
- Failure to use caution could result in cuts or other injuries.

Important Safety Instructions

- Never leave the appliance unattended when in use. Boil over causes smoking and greasy spillovers that may ignite.
- Never use your appliance as a work or storage surface.
- Never leave any objects or utensils on the appliance.
- Do not place or leave any magnetisable objects (e.g. credit cards, memory cards) or electronic devices (e.g. computers, MP3 players) near the appliance, as they may be affected by its electromagnetic field.
- Never use your appliance for warming or heating the room.
- After use, always turn off the cooking zones and the cooktop as described in this manual (i.e. by using the touch controls). Do not rely on the pan detection feature to turn off the cooking zones when you remove the pans.
- Do not allow children to play with the appliance or sit, stand, or climb on it.
- Do not store items of interest to children in cabinets above the appliance. Children climbing on the cooktop could be seriously injured.
- Do not leave children alone or unattended in the area where the appliance is in use.

- Do not repair or replace any part of the appliance unless specifically recommended in the manual. All other servicing should be done by a qualified technician.
- Do not use a steam cleaner to clean your cooktop.
- Do not place or drop heavy objects on your cooktop.
- Do not stand on your cooktop.
- Do not use scourers or any other harsh abrasive cleaning agents to clean your cooktop, as these can scratch the Induction glass.
- If the power supply cable is damaged, it must only be replaced by a qualified technician.
- This appliance is intended to be used in household and similar applications such as:
 - staff kitchen areas in shops, offices and other working environments;
 - farm houses;
 - by clients in hotels, motels and other residential type environments; and
 - bed and breakfast type environments.
- This appliance is not intended for use by persons (including children) with reduced physical, sensory or mental capabilities, or lack of experience and knowledge, unless they have been given supervision or instruction concerning use of the appliance by a person responsible for their safety.
- Children shall not play with the appliance.
- Cleaning and user maintenance shall not be made by children without supervision.
- **WARNING:** Unattended cooking on a cooktop with fat or oil can be dangerous and may result in fire. NEVER try to extinguish a fire with water, but switch off the appliance and then cover flame e.g. with a lid or a fire blanket.
- Metallic objects such as knives, forks, spoons and lids should not be placed on the cooktop surface since they can get hot.
- After use, switch off the cooktop element by its control and do not rely on the pan detector.
- The appliance is not intended to be operated by means of an external timer or separate remote-control system.
- **CAUTION:**The cooking process has to be supervised. A short term cooking process has to be supervised continuously.
- **WARNING:**In order to prevent tipping of the appliance, stabilizing means must be installed. Refer to the instructions for installation.
- **WARNING:**Use only cooktop guards designed by the manufacturer of the cooking appliance or indicated by the manufacture of the appliance in the instruction for use as suitable or cooktop guards incorporated in the appliance. The use of inappropriate guards can cause accidents.
- This appliance incorporates an earth connection for functional purposes only.

- The air extraction system is for home use only, and not suitable for barbecue, roast shop and other commercial purposes.
- The air extraction system and its filter should be cleaned regularly to maintain it in good working condition.
- Clean the air extraction system according to the instructions in the User Manual to avoid possible danger of fire.
- Before connecting this appliance check that the power cord is not damaged. A damaged power cord must be replaced by qualified service personnel only in order to avoid a hazard.
- Ensure there is adequate ventilation of the room especially when the air extraction system is used at the same time as other appliances.
- CAUTION: This extraction system is not intended to be used with gas cooktops.
- CAUTION: Accessible parts may become hot when used with cooking appliance.

Electrical Shock Hazard

Only connect this unit into a properly earthed outlet. If in doubt seek advice from a suitably qualified electrical engineer.

Failure to follow these instructions can result in death, fire, or electrical shock.



Warning: It must be ensured that this appliance is connected only to a 230VAC per phase +10%/-6% 50 Hz mains power supply which continuously complies with the relevant Australian standard. Failure to do may seriously damage the appliance and any such damage is not covered by the manufacturer's warranty.



Overview of Induction Cooktop and Integrated Air Extraction System

The induction cooktop is combined with an effective air extraction system, which is safe, advanced, efficient and may be installed in either ducted or recirculation mode. When you cook, the fumes are simply and quietly extracted via the inlet grill.

Top View

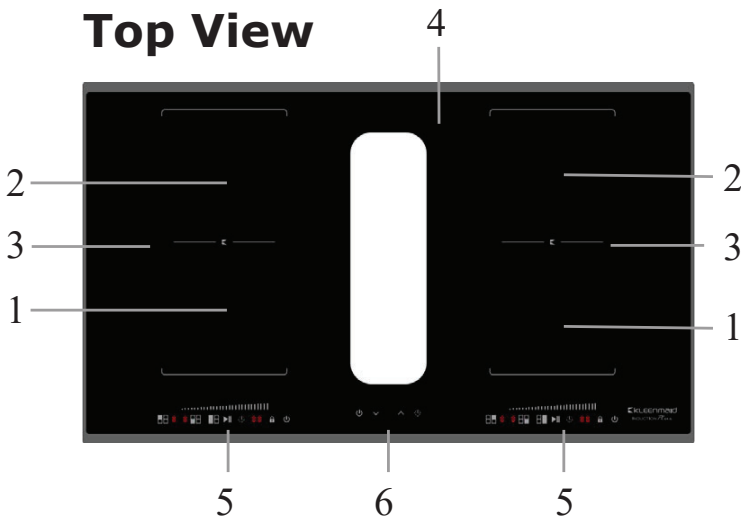

1. Left front /Right front zone
Power/Size: 1500w, 160mm
2. Left rear/Right rear zone
Power/Size: 2000w, 180mm
3. Flex Zone Power/Size: 3000W,
180mm x 360mm
4. Glass
5. Left & right cooktop control panels
6. Air extraction system control panel

Cooktop Control Panel

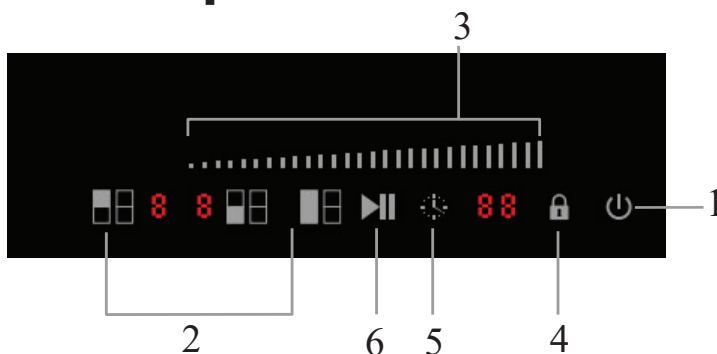

- Left Side Control Panel As Example
1. ON/OFF control
 2. Cooking zone selection controls
 3. Power / Timer slider control
 4. Child keylock control
 5. Timer selector
 6. Pause/Resume function

Extractor Control Panel

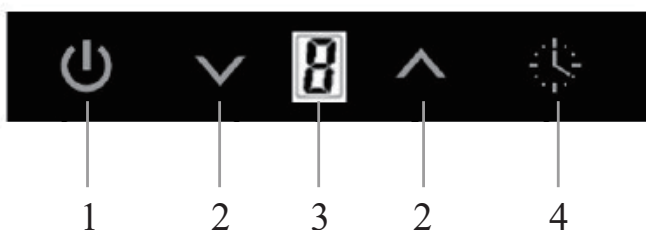

1. ON/OFF control
2. Speed control
3. Digital display (1-3, boost)
4. Timer control

Induction Cooking

Induction cooking is a safe, advanced, efficient, and economical cooking technology. It works by electromagnetic vibrations generating heat directly in the pan, rather than indirectly through heating the glass surface. The glass becomes hot only because the pan eventually warms it up.

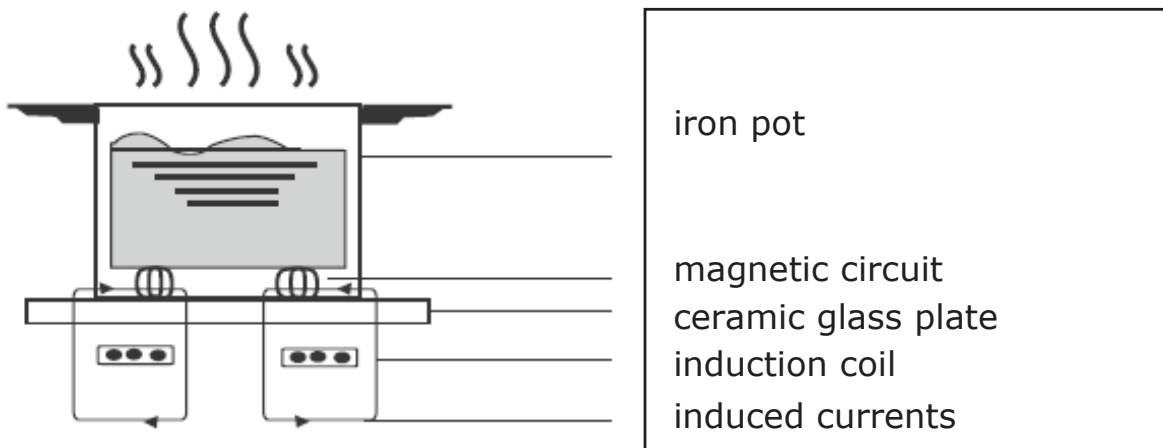

Before Using Your New Cooktop

- Read this guide, taking special note of the 'Safety Warnings' section.
- Remove any protective film that may still be on your Induction cooktop.
- It is recommended that for general use the Air Extraction System is turned on before the Cooktop.

Using the Touch Controls

- The controls respond to touch, so you don't need to apply any pressure.
- Use the ball of your finger, not its tip.
- You will hear a beep each time a touch is registered.
- Make sure the controls are always clean, dry, and that there is no object (e.g. a utensil or a cloth) covering them. Even a thin film of water may make the controls difficult to operate.

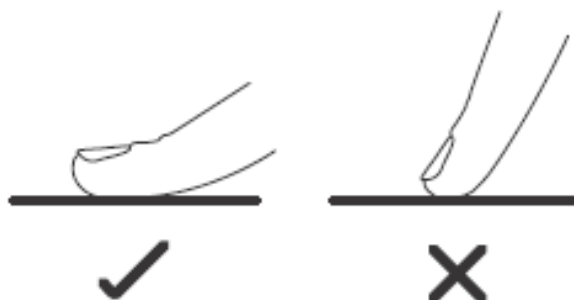

Choosing the Right Cookware



• Only use cookware with a base suitable for induction cooking. Look for the induction symbol on the packaging or on the bottom of the pan.

- You can check whether your cookware is suitable by carrying out a magnet test. Move a magnet towards the base of the pan. If it is attracted, the pan is suitable for induction.
- If you do not have a magnet:

1. Put some water in the pan you want to check.

2. If  does not flash in the display and the water is heating, the pan is suitable.

• Cookware made from the following materials is not suitable: pure stainless steel, aluminium or copper without a magnetic base, glass, wood, porcelain, ceramic, and earthenware.

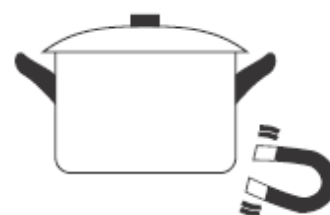

Do not use cookware with jagged edges or a curved base.



Make sure that the base of your pan is smooth, sits flat against the glass, and is the same size as the cooking zone. Use pans whose diameter is as large as the graphic of the zone selected. The further the pan extends over the sides of the burner, the less effective the burner will be. If you use a smaller pot efficiency could also be less than expected. Always centre your pan on the cooking zone.

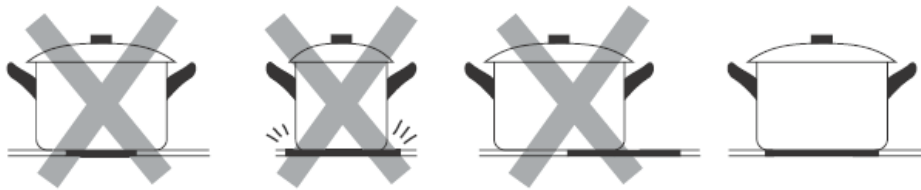

Always lift pans off the Induction cooktop – do not slide or they may scratch the glass.

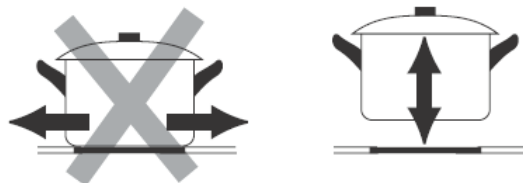

Pan Dimensions

Within certain limits the cooking zones automatically adapt to the diameter of the pan placed on them, however there is a specified minimum diameter for the bottom of a pan to be used on each cooking zone (see table below). To obtain the most efficient cooking operation, please place the pan in the centre of the cooking zone.

Cooking Zone

- 1 Rear left/Rear right zone
- 2 Front left/Front right zone
- 3 Flex zone

Minimum Diameter mm

- 140
120
≥200



THE USE OF EITHER POOR QUALITY POT OR ANY INDUCTION ADAPTOR PLATE FOR NON-MAGNETIC COOKWARE RESULTS IN A WARRANTY BREACH. IN THIS CASE, THE MANUFACTURER CANNOT BE HELD RESPONSIBLE FOR ANY DAMAGE CAUSED TO THE HOB AND/OR ITS ENVIRONMENT.



Using the Extraction System

It is recommended that for general use the Air Extraction System is turned on before the cooktop.

Touch control panel for ease of operation

 On/off.



 Touch to increase the speed.



 Touch to decrease the speed.

 Timer control.

 The digital display indicates: 1 for low speed.
2 for medium speed.
3 for high speed.
b for Boost function (maximum speed).

Control Keys for the air extraction system

Turn on the extraction system: Touch the on/off button  and the extractor will commence operation at the same speed at which it was last used. Touch  to increase or  to decrease the extractor speed. Touch the on/off button to turn off.

Quick timer: Touch  and  for 1 second or touch the timer control.  The display will flash and the 5 minute countdown will begin.

If the timer control  is pressed repeatedly during the countdown the display will stop flashing and the countdown will cease.

At the end of the 5 minute countdown the extractor motor and the light will turn off automatically. The display continues to flash, and the beeping continues. Press any key to stop the beeping and flashing and return to standby state. If there is no action, it will automatically return to standby after 5 seconds.

Boost function: Press and hold  until the buzzer sounds. The indicator light will keep flashing. The Boost speed will engage and the digital display will show 'b' flashing. After operating for 5 minutes the Boost function will cease and the extractor will return to speed 3 automatically.

To cancel the Boost function during operation press and hold  to return to speed 3.

Using the Cooktop

Cooking Zones: These instructions are for the left side of the control panel. The right side operates in a similar manner, using the equivalent buttons and display.

To start cooking

1. Touch the ON/OFF  control.
After power on, the buzzer beeps once, all displays show " - " indicating that the induction cooktop has entered the standby mode.

2. Place a suitable pan on the cooking zone that you wish to use.
 - Make sure the bottom of the pan and the surface of the cooking zone are clean and dry.

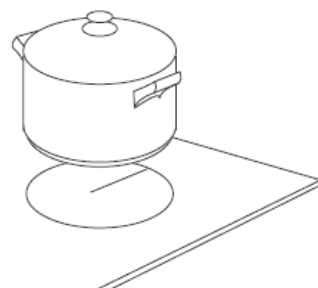

3. Touch the cooking zone selection control, and an indicator next to the key will flash.

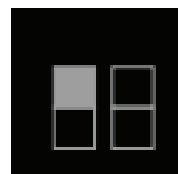



4. Select a power level by sliding from left to right along the power level control until the desired power level (0-9) is shown in the display.



- If you don't choose a power level within 1 minute, the cooktop will automatically switch off. You will need to start again at step 1.
- You can modify the power level at any time during cooking.

To Use the Flex Zone

This area can be used as a single zone or as two different zones, according to cooking needs.

Select a heat setting by touching the  control to use the left Flex zone. (There is no need need to select the Left front zone or Left rear zone separately.) Touch the  control again if you want to cancel the Flex Zone during operation.

Follow the same procedure to use the right Flex Zone, using the  control.

Correct and incorrect layout of pans on Flex zones. See also Pan Dimensions on page 10.

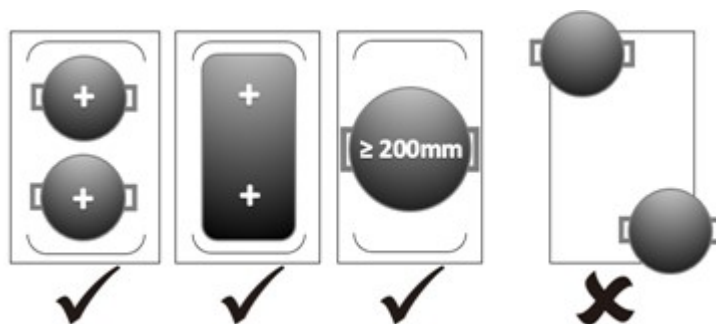

If the display flashes “U” alternately with the power level

This means that:

- there is no pan placed on the correct cooking zone or,
- the pan being used is not suitable for induction cooking or,
- the pan is too small or not properly centered on the cooking zone.

The display will automatically turn off after 2 minutes if no suitable pan is placed on it.

No heating takes place unless there is a suitable pan on the cooking zone.

When Cooking is Finished

1. Touch the cooking zone selection control of the zone to be switched off.
2. Turn the cooking zone off by sliding the power level down to “0”. Make sure the display shows “0”.
3. Turn the whole cooktop off by touching the ON/OFF control.
4. Beware of hot surfaces. “H” (Residual Heat Indicator) will show which cooking zone is hot to touch. It will disappear when the surface has cooled down to a safe temperature ($60\pm 12^{\circ}\text{C}$). It can also be used as an energy saving function, by using the zone that is still hot to heat other pans.

Locking the Controls

- The controls can be locked to prevent unintended use (for example children accidentally turning the cooking zones on).
- When the controls are locked, all the controls except the ON/OFF and Pause/Resume controls are disabled.

To Lock the Controls

Touch the keylock control.  The timer indicator will show " Lo "

To Unlock the Controls

1. Make sure the cooktop is turned on.
2. Touch and hold the keylock control  until "Lo" is not displayed.
3. The cooktop is now ready to use.



When the cooktop is in lock mode, all the controls are disabled except ON/OFF and Pause/Resume. The induction cooktop can be turned off with the ON/OFF control in an emergency, but then it must be unlocked before the next operation.

Over-Temperature Protection

A temperature sensor monitors the temperature inside the Induction cooktop. When an excessive temperature is detected, the Induction cooktop will stop heating automatically, and the cooling fan will operate for 1 min. If this situation occurs again, check the installation for sufficient ventilation allowance.

Detection of Small Articles

When an unsuitable size or non-magnetic pan (e.g. aluminium), or some other small item (e.g. knife, fork, key) has been left on the heated cooktop, the display will flash "U" alternatively with the heat setting, the cooling fan will operate and the cooktop automatically will enter standby mode in 1 minute. The cooling fan will operate for a further 1 minute.

Auto Shutdown Protection



Auto shut down is a safety protection function for your cooktop. It shuts down automatically if you forget to turn off your cooktop. The default maximum heating duration for various power levels are shown in the table below:

| | | | | | | | | | |
|-------------------------------|---|---|---|---|---|---|---|---|---|
| Power level | 1 | 2 | 3 | 4 | 5 | 6 | 7 | 8 | 9 |
| Default working timer (hours) | 8 | 8 | 8 | 4 | 4 | 4 | 2 | 2 | 2 |



People with a heart pace maker should consult with their doctor before using this or any other induction cooktop.

Pause/Resume Function

If you want to pause the working cooktop, touch button  and the display will show "11 11". To resume cooking, touch the  button again.

Using the Timer

Set the timer to turn one or more cooking zones off after the set time is up. The timer can be set from 00 up to 99 minutes.

1. When the timer is set, it will begin to count down immediately. The display will show the remaining time and the timer indicator will flash for 5 seconds.
2. Buzzer will beep for 30 seconds and the timer indicator shows "- -" when the set time is finished.

Setting the timer to turn off one cooking zone:

1. Touch the cooking zone selection control, then touch the timer control, the timer display will start flashing the digits "30". If you want to set the timer for 25 minutes (for example):
2. Touch timer control . As the indicator is flashing set the "tens" figure by sliding to choose "2", then press the timer again. As the indicator is flashing set the single digit figure by sliding to the "5". The indicator will start flashing, "25" will show in the timer display for 3-5 seconds, then the timer is set and count down will commence.



Hint: Sliding the timer control from left to right once when the "tens" place is

flashing, will increase the duration by 10 minutes. Sliding the control from right to left will similarly decrease the duration.



Sliding the timer control from left to right once when the single digit place is flashing will increase the duration by 1 minute. Sliding the control from right to left will similarly decrease duration.

3. If the set duration exceeds 99 minutes, the timer will automatically return to 00 minute setting. The digits "00" showing in the minute display indicates the timer is canceled. Press the timer selector to cancel the timer directly.

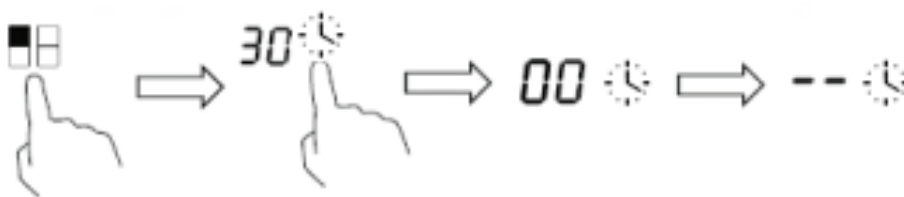

4. When the timer is set, it will begin to count down immediately. The display will show the remaining time and the timer indicator will flash for 5 seconds.

NOTE: The red dot next to the power level indicator will illuminate indicating the zone that is selected.

5. When the cooking timer expires, the corresponding cooking zone will switch off automatically and its related display will show "H" (Residual Heat Indicator).



Other cooking zones will continue operating if they were switched on previously.

Setting the timer to turn off more than one cooking zone:

1. If this function is used for more than one cooking zone, the timer indicator will show the shortest time.
(e.g. if a zone has a set time of 3 minutes, and another zone has a set time of 6 minutes, the timer indicator shows "3".)

NOTE: The flashing red dot next to the power level indicator means the

timer indicator is showing the time of that cooking zone. If you want to check the set time of another cooking zone, touch the cooking zone selection control. The timer will indicate its set time.

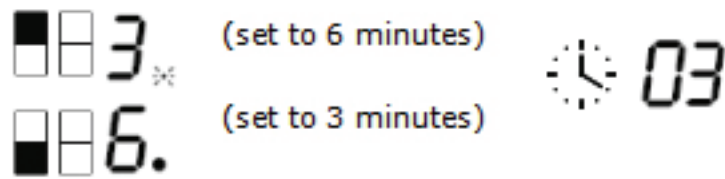

2. When cooking timer expires, the corresponding cooking zone will automatically switch off and show "H" (Residual Heat Indicator).



NOTE: To change the time after the timer is set, start again from step 1.

Cooking Guidelines



Take care when frying as the oil and fat heat up very quickly, particularly if you're using high power. At extremely high temperatures oil and fat will ignite spontaneously and this presents a serious fire risk.

Cooking Tips

- When food comes to the boil, reduce the temperature setting.
- Using a lid will reduce cooking times and save energy by retaining heat.
- Minimise the amount of liquid or fat to reduce cooking times.
- Start cooking on a high setting and reduce the setting when the food has heated through.

Simmering, cooking rice

- Simmering occurs below boiling point, at around 85°C, when bubbles are just rising occasionally to the surface of the cooking liquid. It is the key to delicious soups and tender stews because the flavours develop without overcooking the food. You should also cook egg-based and flour-thickened sauces below boiling point.
- Some tasks, including cooking rice by the absorption method, may require a setting higher than the lowest setting to ensure the food is cooked properly in the time recommended.

Searing steak

To cook juicy flavoursome steaks:

1. Stand the meat at room temperature for about 20 minutes before cooking.

2. Heat up a heavy-based frying pan.
3. Brush both sides of the steak with oil. Drizzle a small amount of oil into the hot pan and then lower the meat onto the hot pan.
4. Turn the steak only once during cooking. The exact cooking time will depend on the thickness of the steak and how cooked you want it. Times may vary from about 2 – 8 minutes per side. Press the steak to gauge how cooked it is – the firmer it feels the more 'well done' it will be.
5. Leave the steak to rest on a warm plate for a few minutes to allow it to relax and become tender before serving.

For stir-frying

1. Choose an induction compatible flat-based wok or a large frying pan.
2. Have all the ingredients and equipment ready. Stir-frying should be quick. If cooking large quantities, cook the food in several smaller batches.
3. Preheat the pan briefly and add two tablespoons of oil.
4. Cook any meat first, put it aside and keep warm.
5. Stir-fry the vegetables. When they are hot but still crisp, turn the cooking zone to a lower setting, return the meat to the pan and add your sauce.
6. Stir the ingredients gently to make sure they are heated through.
7. Serve immediately.

Heat Settings

The settings below are guidelines only. The exact setting will depend on several factors, including your cookware and the amount you are cooking. Experiment with the induction cooktop to find the settings that best suit you.

| Heat setting | Suitability |
|---------------------|--|
| 1 - 2 | <ul style="list-style-type: none"> • delicate warming for small amounts of food • melting chocolate, butter, and foods that burn quickly • gentle simmering • slow warming |
| 3 - 4 | <ul style="list-style-type: none"> • reheating • rapid simmering • cooking rice |
| 5 - 6 | <ul style="list-style-type: none"> • pancakes |
| 7 - 8 | <ul style="list-style-type: none"> • sautéing • cooking pasta |
| 9 | <ul style="list-style-type: none"> • stir-frying • searing • bringing soup to the boil • boiling water |

Care and Cleaning

| What? | How? | Important! |
|---|--|---|
| <p>Everyday soiling on glass (fingerprints, marks, stains left by food or non-sugary spillovers on the glass)</p> | <ol style="list-style-type: none"> 1. Switch the power to the cooktop off. 2. Apply a cooktop cleaner while the glass is still warm (but not hot)! 3. Rinse and wipe dry with a clean cloth or paper towel. 4. Switch the power to the cooktop back on. | <ul style="list-style-type: none"> • When the power to the cooktop is switched off, there will be no 'hot surface' indication but the cooking zone may still be hot! Take extreme care. • Heavy-duty scourers, some nylon scourers and harsh/abrasive cleaning agents may scratch the glass. Always read the label to check if your cleaner or scourer is suitable. • Never leave cleaning residue on the cooktop: the glass may become stained. |
| <p>Boilovers, melts, and hot sugary spills on the glass</p> | <p>Remove these immediately with a fish slice, palette knife or razor blade scraper suitable for Induction glass cooktops, but beware of hot cooking zone surfaces:</p> <ol style="list-style-type: none"> 1. Switch the power to the cooktop off at the wall. 2. Hold the blade or utensil at a 30° angle and scrape the soiling or spill to a cool area of the cooktop. 3. Clean the soiling or spill up with a dish cloth or paper towel. 4. Follow steps 2 to 4 for 'Everyday soiling on glass' above. | <ul style="list-style-type: none"> • Remove stains left by melts and sugary food or spillovers as soon as possible. If left to cool on the glass, they may be difficult to remove or even permanently damage the glass surface. • Cut hazard: when the safety cover is retracted, the blade in a scraper is razor-sharp. Use with extreme care and always store safely and out of reach of children. |
| <p>Spillovers on the touch controls</p> | <ol style="list-style-type: none"> 1. Switch the power to the cooktop off. 2. Soak up the spill 3. Wipe the touch control area with a clean damp sponge or cloth. 4. Wipe the area completely dry with a paper towel. 5. Switch the power to the cooktop back on. | <ul style="list-style-type: none"> • The cooktop may beep and turn itself off, and the touch controls may not function while there is liquid on them. Make sure you wipe the touch control area dry before turning the cooktop back on. |

Filter Maintenance and Replacement

Your Kleenmaid Air Extraction System has the following types of filters:

1. The visible aluminum grease filter. These filters should be removed, cleaned and re-installed at least every three months, and more often if food is regularly fried or grilled. These filters may be cleaned either with a soft-bristled brush in warm soapy water, or in a dishwasher (without other items to avoid contaminating the filter). Ensure that each filter is completely dry before re-installing it into the centre of the cooktop. Normally these filters will last the life of the extractor however if they are damaged in any way, replacements may be purchased by emailing support@kleenmaid.com.au or calling 02 9310 1207.

To clean the filter:

Ensure appliance is turned off.

Remove the inlet grill in the centre of the cooktop.

Remove grease filter cassette and remove filter from cassette.

Wash filter in dishwasher, allow to dry and replace filter in cassette.

Replace grease filter cassette, ensuring the hole in the side of the cassette is on the same side as the air outlet.

Replace inlet grill.

2. The internal Kleenmaid Activated Charcoal (or “Carbon”) Filter. This filter is located in the air outlet box mounted in the kick plate and removes cooking odours from the air if the extractor is installed in recirculating rather than venting mode. These filters cannot be cleaned and will require replacement. The effective life of the filter depends on the type and amount of cooking you do. Generally the life of these filters is approximately six months. However, always replace the filter when it no longer absorbs odours effectively. When replacement Kleenmaid Activated Charcoal filters are required they may be purchased by visiting the Kleenmaid website www.kleenmaid.com.au, emailing support@kleenmaid.com.au or calling 02 9310 1207.

To change the Activated Charcoal filter:

Ensure appliance is turned off.

Remove the stainless steel outlet grill from the kickplate.

Remove carbon filter box behind outlet grill, take out charcoal filter and replace with new filter.

Replace carbon filter box and stainless steel outlet grill.

Warning: It must be ensured that the filters are correctly installed whenever the Air Extraction System is operating. Failure to do so may damage the extractor and such damage will not be covered by the manufacturer’s warranty.

Installation

Note: Before making preparations for or commencing installation, the installer should refer to the current online version of the User Manual, which is available on the Kleenmaid website (see back cover for details).

Warning: The interconnection cable, wherever it may become accessible, must be enclosed within a protective electrical conduit compliant with the local electrical wiring regulations.

Selection of installation location

Cut out the work surface according to the sizes shown in the drawing.

For the purpose of installation and use, a minimum of 5 cm space shall be preserved around the hole.

Be sure the thickness of the work surface is at least 30mm. Please select heat resistant work surface material to avoid larger deformation caused by the heat radiation from the hotplate. As shown below:

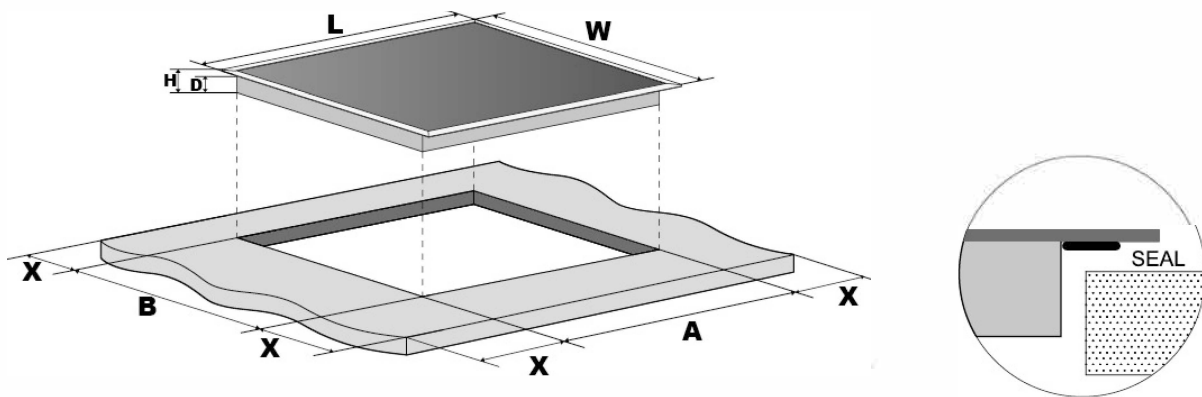

| L(mm) | W(mm) | H(mm) | D(mm) | A(mm) | B(mm) | X(mm) |
|-------|-------|-------|-------|-------|-------|--------|
| 880 | 520 | 61 | 55 | 770 | 490 | S0 min |

Fixing Brackets

The cooktop is fixed to the benchtop using the brackets and screws supplied. See diagram below:

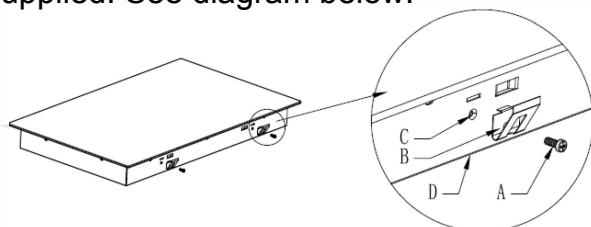

| A | B | C | D |
|-------|---------|------------|------|
| screw | bracket | Screw hole | base |

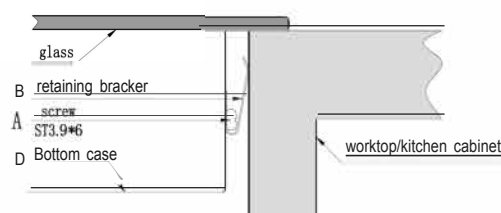

MAIN COMPONENT DIMENSIONS

COOKTOP ASSEMBLY

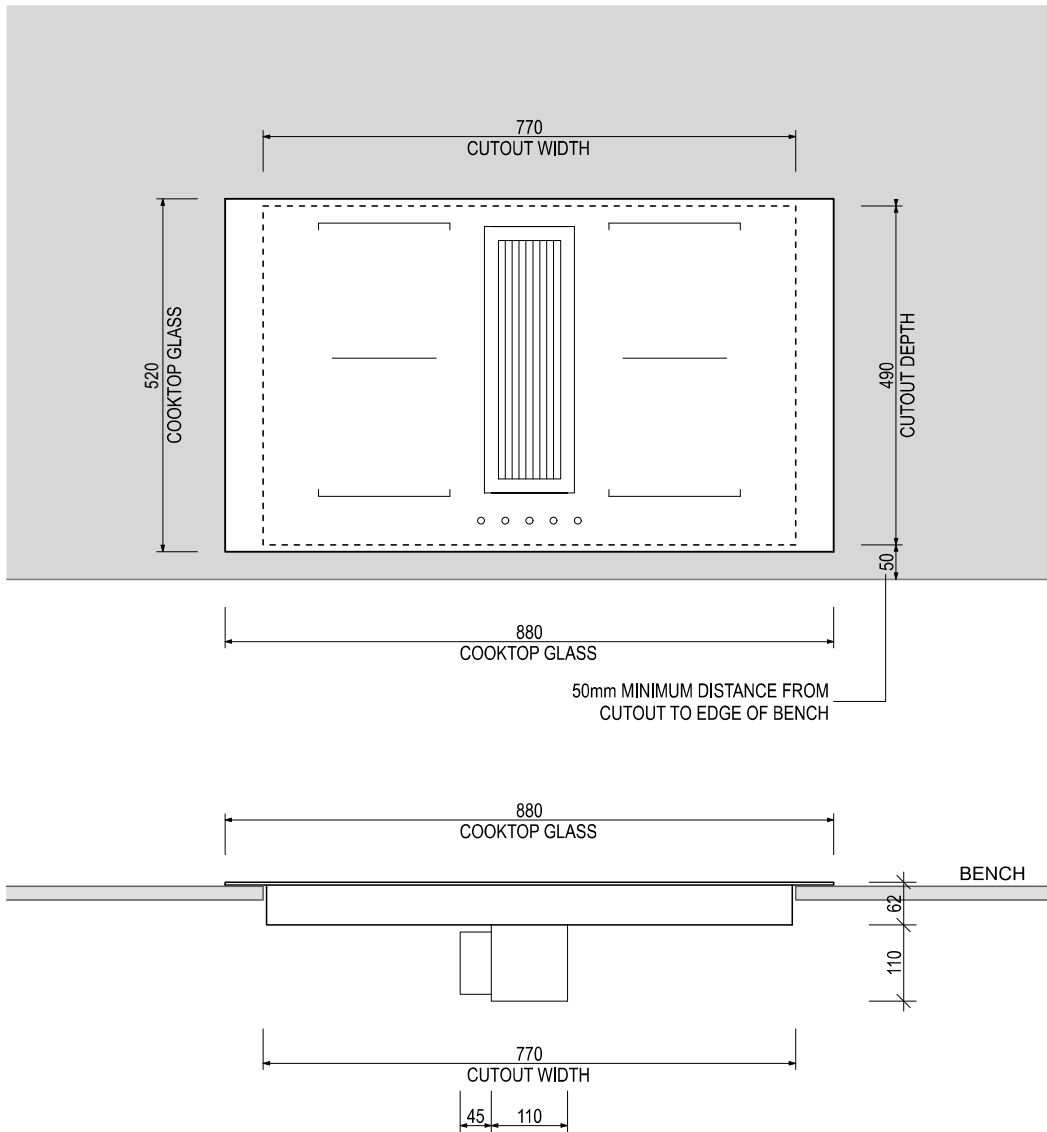

NOTE: Minimum vertical clearance, from the bottom of the cooling fan grilles under the cooktop assembly, to any other object is 8mm. This applies to the fan on the left and the right of the cooktop.

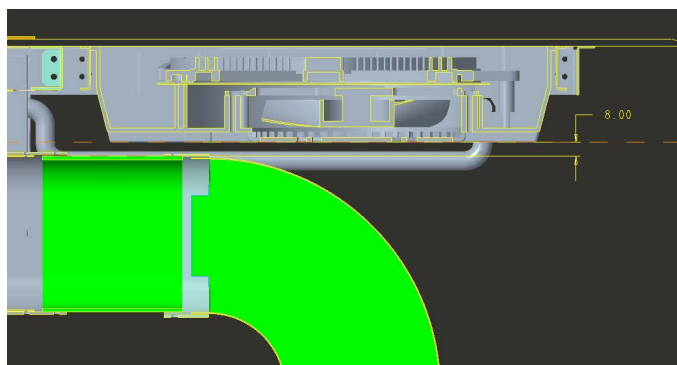

BLOWER MOTOR ASSEMBLY

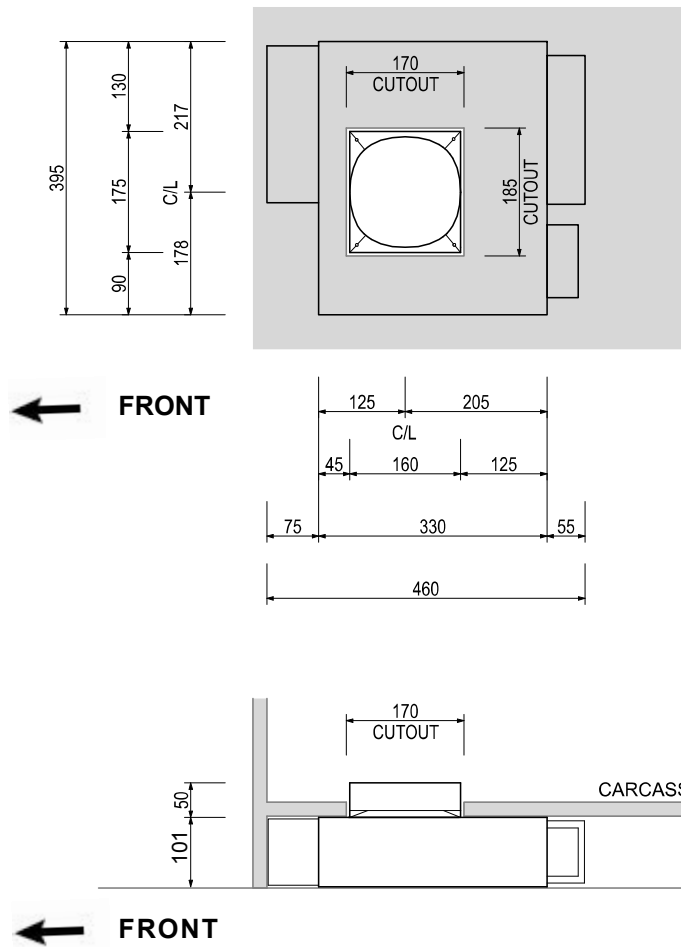

TYPICAL INSTALLATION - 900 x 600 CABINET

CABINET CONSTRUCTION & CUTOUTS

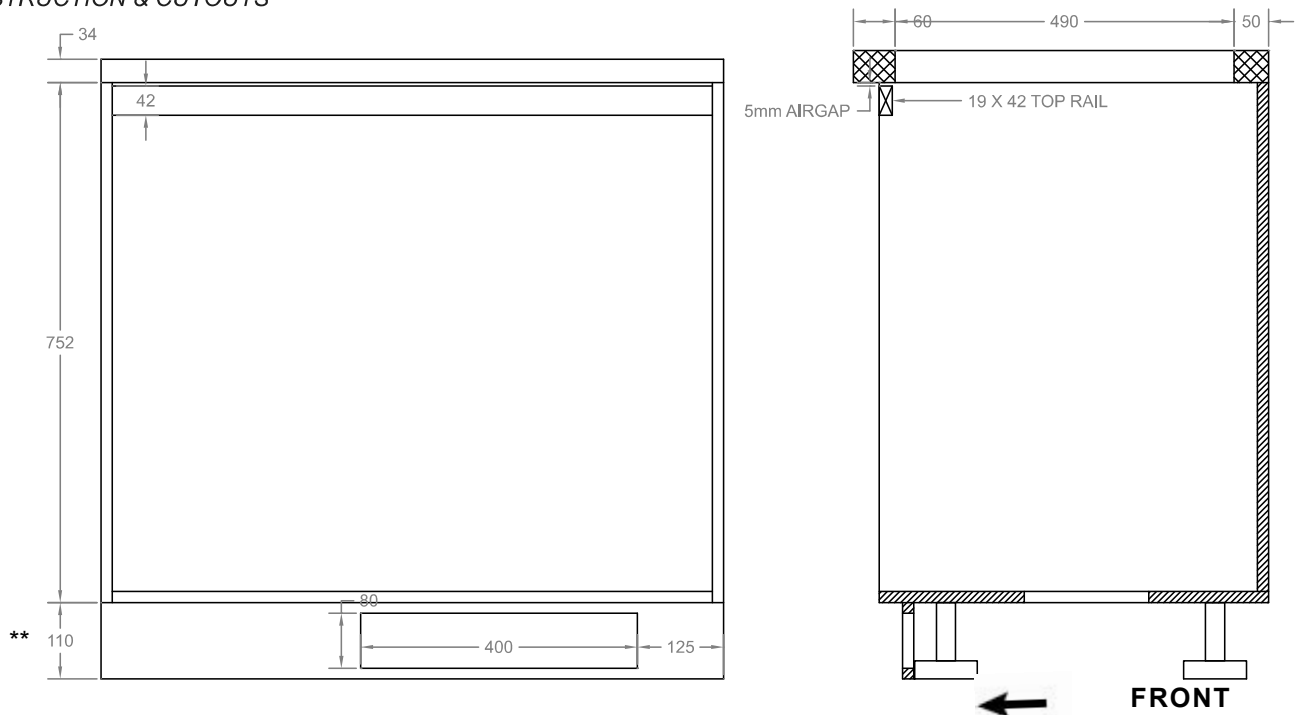

**The height of the underside of the cabinet carcass needs to be at least 101mm (+2mm tolerance) off the floor.

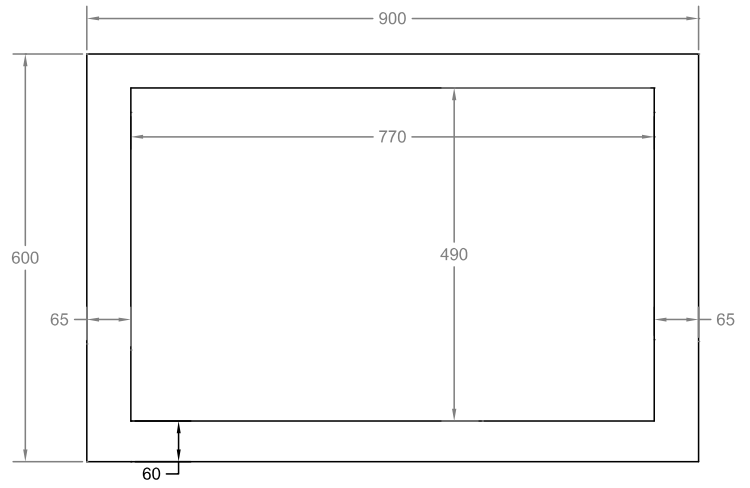
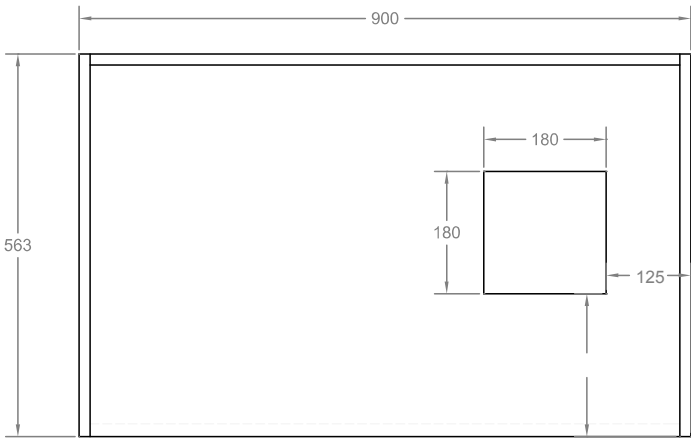

COMPLETED INSTALLATION - 900 x 600 CABINET

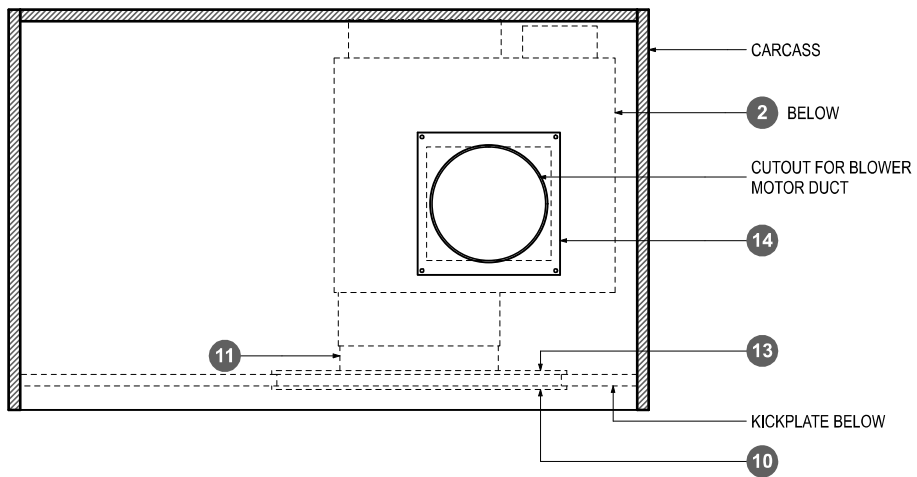
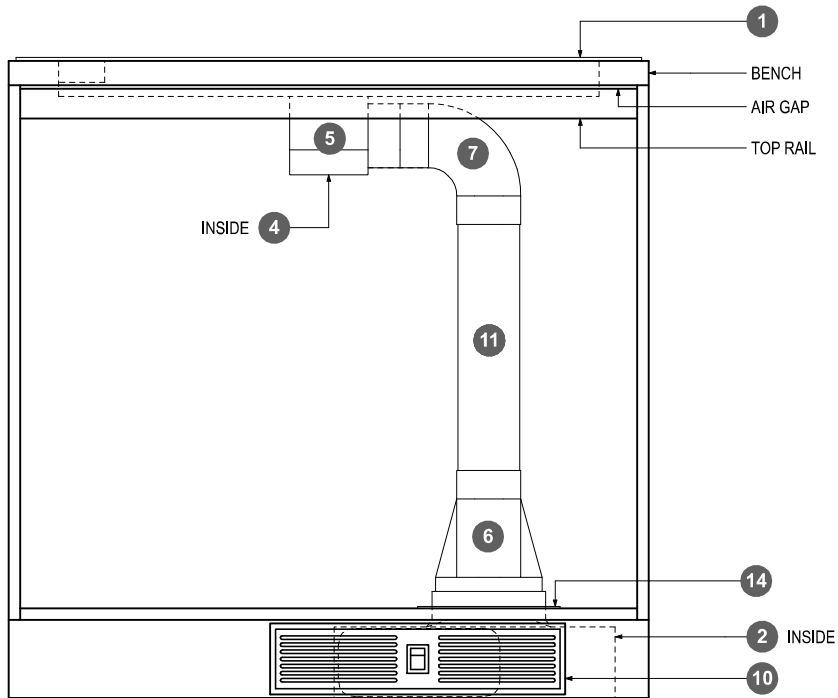

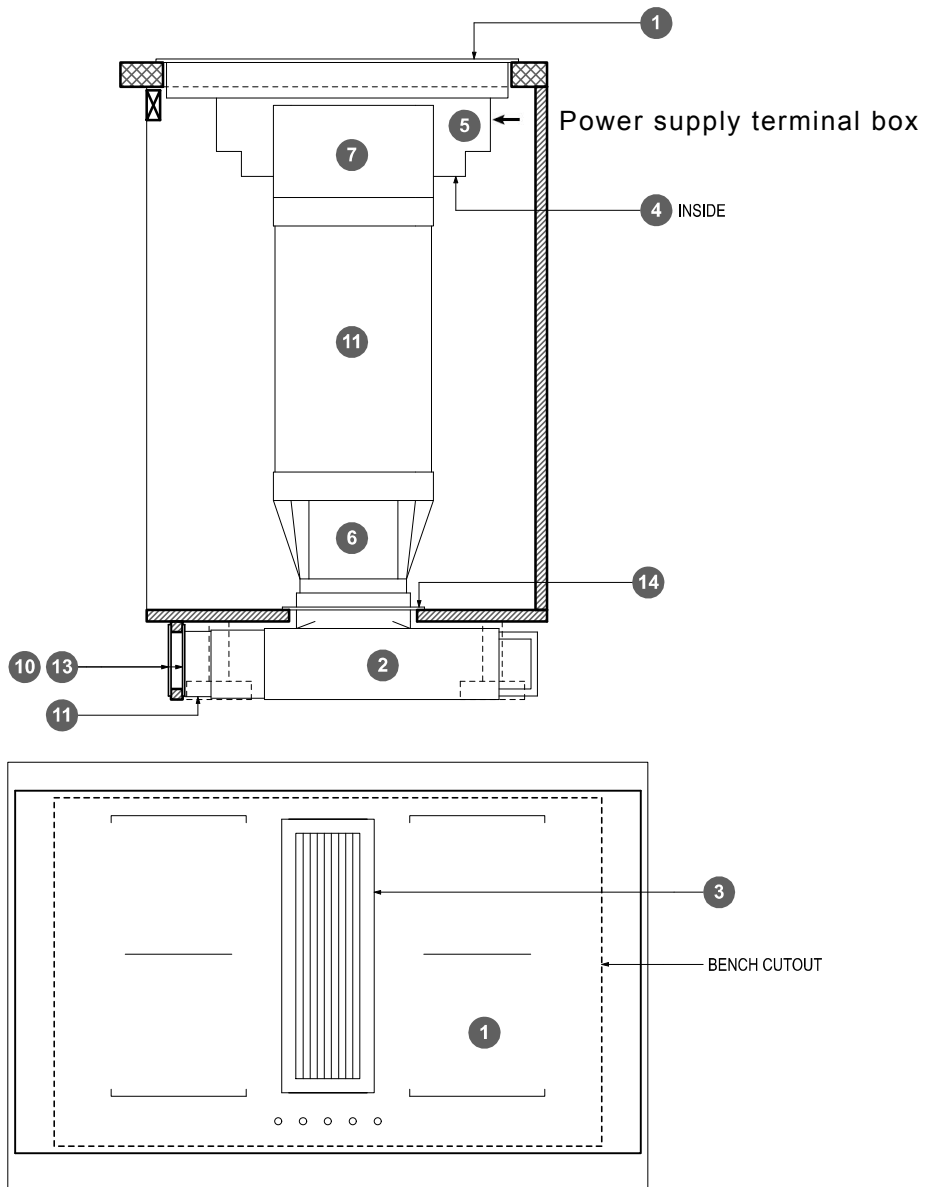

COMPONENT DESCRIPTIONS

- 1 cooktop assembly, including mains power cable

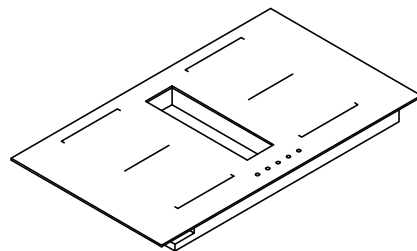

- 2 blower motor assembly, including cooktop interconnection cables

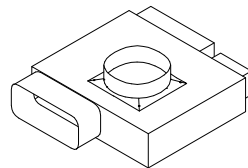

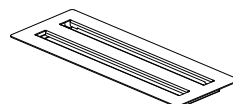

- 3 Inlet grill (matt black steel)



- 4 grease filter & cassette

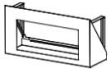

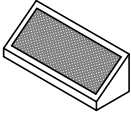
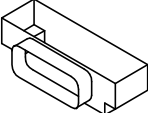
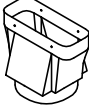
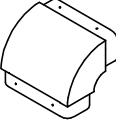
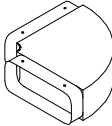
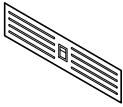
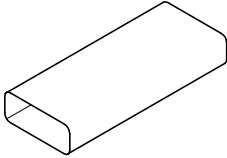
4a grease filter 

4b grease filter cassette 

- 5 grease filter cassette casing 
- 6 blower motor duct adapter with non-return valve 
- 7 downturn elbow 
- 8 horizontal elbow
*optional 
- 10 stainless steel outlet grille 
- 11 straight duct
222mm x 89mm x 1000mm
*optional 
- 12 straight duct inline joiner
222mm x 89mm x 80mm
*optional 
- 13 carbon filter & filter box

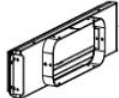
13a carbon filter 

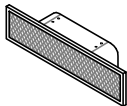
13b carbon filter box 

- 14 trim cover 

N.B. Items marked *optional are site-specific and are purchased separately. All other components are supplied.

COMPONENT DIMENSIONS

These diagrams allow an installation planner to determine the eventual location of the various components after installation.

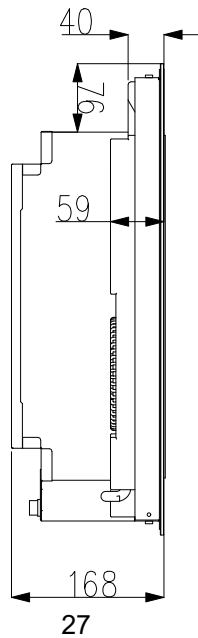
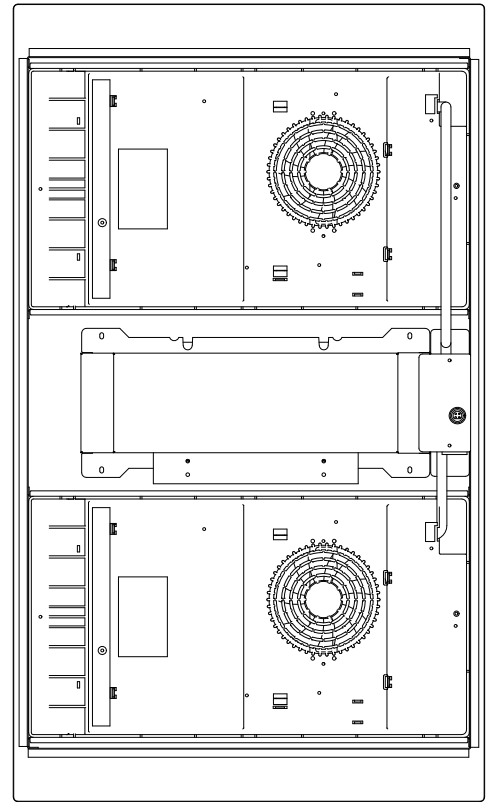
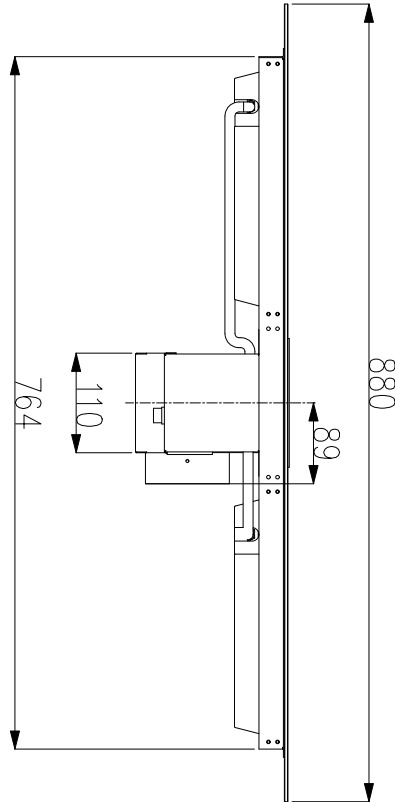
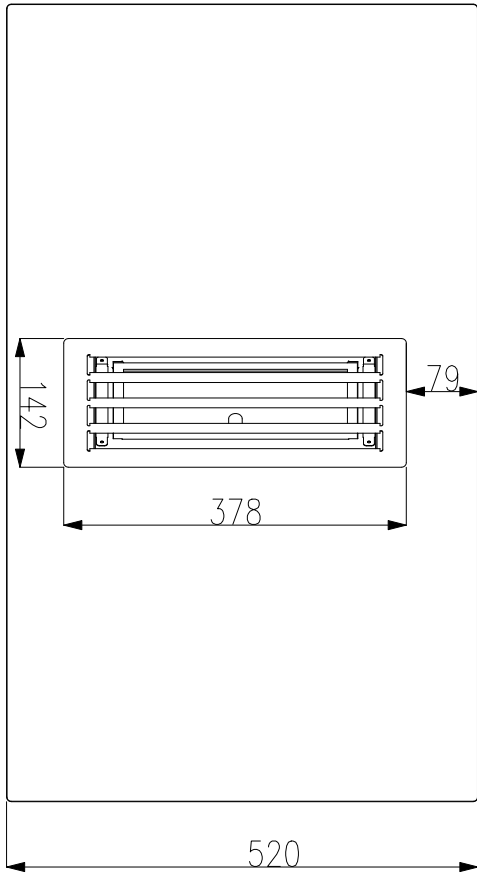
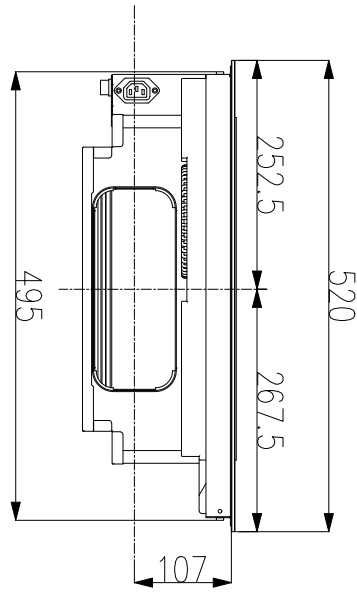

TYPICAL INSTALLATION – 900 x 600 CABINET

ASSEMBLY PROCEDURE (Note: #x refers to part numbers listed on pages 25-26)

1. Screw Cooktop Assembly#1 and Grease Filter Cassette Casing#5 together using 4x supplied screws (M3x8mm).
2. Cut and insert length of Straight Duct#11 to outlet of Grease Filter Cassette Casing#5 (see #11 page 24 - calculate length by measurement).
3. Duct tape Downturn Elbow#7 to the Grease Filter Cassette Casing#5.
4. Temporarily position Cooktop Assembly#1 into the cabinet benchtop.
5. Place the Blower Motor Assembly#2 under the cabinet (remove the black plastic cowl from the top of the Blower Motor Assembly#2 by removing 4 screws, holding it in place, and refitting them from inside the cabinet once the Blower Motor Assembly#2 is in position).
6. Position the Blower Motor Assembly#2 outlet in the desired direction.
7. Place the square Trim Cover#14 over the black plastic cowl of the Blower Motor Assembly#2. This covers and finishes the cutout in the cabinet base.
8. Fit the Blower Motor Duct Adaptor#6 to the black plastic cowl on top of the Blower Motor Assembly#2.
9. Measure the distance (A) between the top of the Blower Motor Duct Adaptor#6 and the bottom of the Downturn Elbow#7.
10. Cut a length of the Straight Ducting#11 to (A+70MM) and place in position. Lift up the Cooktop Assembly#1 slightly in order to position the plastic duct into the Blower Motor Duct Adaptor#2 and Downturn Elbow#7, then place back into its final position.
11. Duct tape joints to secure the duct. (Duct tape not included.)
12. The cooktop is fixed to the benchtop using the brackets and screws supplied. See "Fixing Brackets" on page 21.
13. Cut out the Carbon Filter Box#13b allowance in the kick panel (80mm high and 400mm wide), 20mm off the base of the kickboard.
14. Place the Carbon Filter Box#13b in position in the kick panel, after removing the Outlet Grille#10 (if fitted). You may need to cut a length of plastic ducting to connect the outlet of the Blower Motor Assembly#2 to the inlet of the Carbon Filter Box,#13b depending on the setback of the kick panel from the front of the cabinet.
15. Fit the Outlet Grill#10 to the Carbon Filter Box#13b.
16. Side venting installation uses the same procedure as in 1–15 above. The length of ducting needed from the outlet of the Blower Motor Assembly#2 to the inlet of the Carbon Filter Box#13b is dependent on the desired position of the Carbon Filter Box#13b.

Connecting the Cooktop to the Mains Power Supply



This cooktop must be connected to the mains power supply only by a suitably qualified person.

Before connecting the cooktop to the mains power supply, check that:

1. the domestic wiring system is suitable for the power drawn by the cooktop.
2. the voltage corresponds to the value given in the rating plate
3. the power supply cable sections can withstand the load specified on the rating plate. To connect the cooktop to the mains power supply, do not use adapters, reducers, or branching devices, as they can cause overheating and fire.



The power supply cable must not touch any hot parts and must be positioned so that its temperature will not exceed 75°C at any point.

Check with an electrician whether the domestic wiring system is suitable without alterations. Any alterations must only be made by a qualified electrician.

The power supply should be connected in compliance with the relevant standard, or a single-pole circuit breaker. The method of connection is shown below.

- If the cable is damaged or to be replaced, the operation must be carried out by an authorised technician to avoid electrical hazard.
- If the appliance is being connected directly to the mains an omnipolar circuit-breaker must be installed with a minimum opening of 3mm between contacts.
- The installer must ensure that the correct electrical connection has been made and that it is compliant with safety regulations.
- The cable must not be bent or compressed.
- The cable must be checked regularly and replaced by authorised technicians only.
- The yellow/green wire of the power supply cable must be connected to the earth of both power supply and appliance terminals.
- The manufacturer cannot be held responsible for any accidents resulting from the use of an appliance which is not connected to earth, or with faulty earth connection continuity.
- If the appliance has a socket outlet, it must be installed so that the socket outlet is accessible.

Electrical Diagram

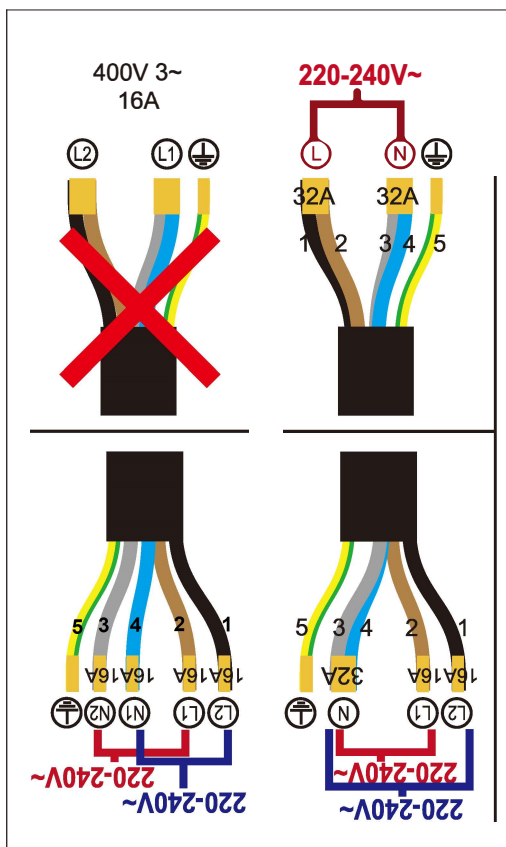

Legend

1. Black
2. Brown
3. Grey
4. Blue
5. Green/yellow

Instructions for connecting extractor cables to the cooktop

1. Insert extractor cable plug 1 into socket at side of the electrical box at the rear of the cooktop (see diagram below).
2. Align pins of extractor cable plug 2 with the socket underneath the electrical box at the rear of the cooktop (see diagram below) by aligning the special matching shapes of the plug and the socket. Push in firmly and screw on the collar to retain the plug.

Warning: Ensure the plug and socket are aligned before inserting the plug, or damage to the pins may occur.

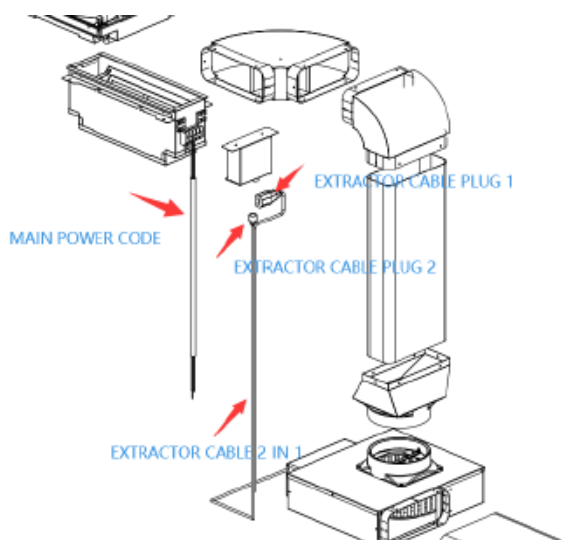

Technical Specifications

| | |
|---|--------------------|
| ICTFX9020EX(Extractor)&ICTFX9020HB(Cooktop) | |
| Cooking Zones | 4 Zones |
| Supply Voltage | 220-240V~, 50-60Hz |
| Cooktop maximum absorbed power | 7000 W |
| Air extractor maximum absorbed power | 150W |
| Wiring/breaker rating | 32A |

Weight and Dimensions are approximate. Because we continually strive to improve our products we may change specifications and designs without prior notice.

| | |
|---|---|
|  | <p>This appliance is labeled in compliance with European directive 2002/96/EC for Waste Electrical and Electronic Equipment (WEEE). By ensuring that this appliance is disposed of correctly, you will help prevent any possible damage to the environment and to human health, which might otherwise be caused if it were disposed of in the wrong way.</p> <p>The symbol on the product indicates that it may not be treated as normal household waste. It should be taken to a collection point for the recycling of electrical and electronic goods.</p> <p>This appliance requires specialist waste disposal.</p> <p>For more detailed information about treatment, recovery and recycling of this product, please contact your local council office, your household waste disposal service or the shop where you purchased the product.</p> |
|---|---|

DISPOSAL: Do not dispose of this product as unsorted municipal waste. Collection of such waste separately for special treatment is necessary.

Hints and Tips

| Problem | Possible causes | What to do |
|--|--|--|
| The induction cooktop cannot be turned on. | No power. | Make sure the induction cooktop is connected to the power supply and that it is switched on. Check whether there is a power outage in your home or area. If you've checked everything and the problem persists, call a qualified technician. |
| The touch controls are unresponsive. | The controls are locked. | Unlock the controls. See section 'Using your induction cooktop' for instructions. |
| The touch controls are difficult to operate. | There may be a slight film of water over the controls or you may be using the tip of your finger when touching the controls. | Make sure the touch control area is dry and use the ball of your finger when touching the controls. |
| The glass is being scratched. | Rough-edged cookware. Unsuitable, abrasive scourer or cleaning products being used. | Use cookware with flat and smooth bases. See 'Choosing the right cookware'. See 'Care and cleaning'. |
| Some pans make crackling or clicking noises. | This may be caused by the construction of your cookware (layers of various metals vibrating differently). | This is normal for cookware and does not indicate a fault. |
| The induction cooktop makes a low humming noise when used on a high heat setting. | This is caused by the technology of induction cooking. | This is normal, but the noise should quieten down or disappear completely when you decrease the heat setting. |
| Fan noise coming from the induction cooktop. | A cooling fan built into your induction cooktop has come on to prevent the electronics from overheating. It may continue to run even after you've turned the induction cooktop off. | This is normal and needs no action. Do not switch the power to the induction cooktop off at the wall while the fan is running. |
| Pans do not become hot and  appears in the display. | The induction cooktop cannot detect the pan because it is not suitable for induction cooking. The induction cooktop cannot detect the pan because it is too small for the cooking zone or not properly centred on it. | Use cookware suitable for induction cooking. See section 'Choosing the right cookware'. Centre the pan and make sure that its base matches the size of the cooking zone. |

| | | |
|---|------------------|---|
| The induction cooktop or a cooking zone has turned itself off unexpectedly, a tone sounds and an error code is displayed (typically alternating with one or two digits in the cooking timer display). | Technical fault. | Please note down the error code displayed (see list of possible codes in table below), switch the power to the induction cooktop off at the wall, and contact a qualified technician. |
|---|------------------|---|

Never attempt to disassemble the unit by yourself.

Error Codes and Troubleshooting

Some errors may cause the appliance to shut down and display the following error codes:

| Error code | Possible cause | What to do |
|------------|---|---|
| F3/F4 | Temperature sensor of the induction coil failure | Please contact the manufacturer. |
| F9/FA | Temperature sensor of the IGBT failure. | Please contact the manufacturer. |
| E1/E2 | Abnormal supply voltage | Please check whether the power supply is normal. Restart when the power supply is normal. |
| E3 | High temperature of the induction coil temperature sensor | Please contact the manufacturer. |
| E5 | High temperature of the IGBT temperature sensor | Please restart after the cooktop cools down. |

The above are the error codes which may be displayed and the most likely explanation. Please do not disassemble the unit by yourself to avoid any danger and damage to the induction cooktop.

Should you need to request a warranty service (see back cover) please note the Model Code ICTFX9020EX, and the individual serial number of this appliance. This information is on the rating label found on the outside surface of the grease filter cassette casing 5 (see p24-26 of this manual).

KLEENMAID WARRANTY

TERMS AND CONDITIONS

1. Compass Capital Services Pty Ltd ABN 96 138 214 525 trading as Kleenmaid will provide parts and labour to you the customer as set out herein.
2. Kleenmaid's Products come with guarantees that cannot be excluded under the Australian Consumer Law. You are entitled to a replacement or refund for a major failure and for compensation for any other reasonably foreseeable loss or damage. You are also entitled to have the goods repaired or replaced if the goods fail to be of acceptable quality and the failure does not amount to a major failure.
3. The benefits given to you under this Kleenmaid Warranty are in addition to other rights and remedies to which you may be entitled under the Australian Consumer Law in relation to the Product to which this Kleenmaid Warranty relates. Subject to the conditions below, the Product is warranted by Kleenmaid and/or its agents to be free from defects in materials and workmanship for the Warranty Period for normal Domestic Use.
4. Product Identification: -
 - a. Kleenmaid reserves the right to reject claims for any services or work where you cannot produce for verification the serial number and a proof of purchase for the Product (including but not limited to the original invoice).
 - b. this Kleenmaid Warranty will be voided if the serial number for the Product cannot be verified. This is not intended to exclude, restrict or modify any right or remedy to which you may otherwise be entitled under the consumer guarantee provisions of the Australian Consumer Law.
 - c. in the event that a request for repair is made against this Kleenmaid Warranty where the serial number for the Product cannot be verified or you cannot produce for verification a proof of purchase for the Product (including but not limited to the original invoice), the repairer will not carry out any repairs on the Product and you will be charged a service call-out fee.
5. What is covered by this Kleenmaid Warranty: -
 - a. the Product is covered for faulty workmanship or parts that have failed under normal Domestic Use.
 - b. Kleenmaid and/or its agents will determine by objective testing if there are any defects in the Product and/or faulty workmanship.
 - c. this Kleenmaid Warranty is only applicable if repairs on Products are carried out within Mainland Australia.
 - d. this Kleenmaid Warranty: -
 - i. covers a Product purchased as new, manufactured for use in Mainland Australia;
 - ii. commences from the date of delivery of the Product;
 - iii. provides for the labour and replacement parts necessary to maintain the Product in good operating condition as specified in this Kleenmaid Warranty, however, if repair is needed because of Product failure during normal Domestic Use, Kleenmaid has the option to repair or replace the defective Product or part of the Product with a product or part of like kind and quality. A replacement part may be new or reconditioned of like kind and quality and may cost less than the original Product purchased and no charges or refunds will be made based on the replacement product or part cost difference; and
 - iv. is only applicable when the Product is used and operated in accordance with the Manufacturer's instructions.
6. What is not Covered by this Kleenmaid Warranty (excluded):-
 - a. any damage or failure to or of the Product or part of the Product:
 - i. due to the Product being inadequately serviced to manufacturer's recommendations;
 - ii. resulting from environmental conditions including and not limited to dirt, dust, rodents, insects, rust, corrosion, salt built-up, of or in any part of the Product;
 - iii. resulting from excessive use but fair wear and tear is excepted;
 - iv. resulting from poor installation including and not limited to positioning and externally fitted equipment such as plumbing and drainage, cabling, antennae or due to incompatibility of connected equipment;
 - v. caused by overheating as a result of sitting or positioning of the Product, where there is no provision for adequate ventilation or adequate protection from excessive dust;
 - vi. if the Product has been dismantled, repaired or serviced by any person other than someone authorised by Kleenmaid or its agents or representatives;
 - vii. caused by power surges or spikes, including and not limited to, mains power and telecommunications connections, or to other unspecified sources, incorrect power current, voltage fluctuation, amperage fluctuation, rust or corrosion;
 - viii. if the Product is dropped, collision of the Product with another object, use for which the Product is not designed, damage to the Product caused by your own negligence, accidental or deliberate misuse of the Product by you, theft, abuse, vandalism, flood, fire, earthquake, electrical storms or any other act of God or any war related events; or
 - ix. due to the introduction of abnormal heat loads to the Product;
 - b. costs of attendance and testing where no fault or defect covered by the terms of this Kleenmaid Warranty is identified in the Product;
 - c. initial setup and installation of the Product;
 - d. normal maintenance costs and costs incurred through the installation of items listed as requiring periodic replacement;
 - e. Products with removed or altered serial numbers;
 - f. broken or cracked glass other than transport damage to the initial point of delivery;
 - g. consumables such as but not limited to bulbs/globes, seals, filters, batteries and remote controls;
 - h. removal and reinstallation of an internal component not performed by an authorised Kleenmaid agent or representative or authorised service centre;
 - i. cosmetic or structural items; or
 - j. any failures due to interference from or with other products and/or sources.
7. This Kleenmaid Warranty ceases if: -
 - a. the Product ceases to carry the original manufacturer's serial number or is sold at an auction;
 - b. the Product is rented; or
 - c. there is failure to pay monies owing on invoices as a result of non-warranty work being carried out at the request of the end user as per point 16 below.
8. Neither Kleenmaid nor its representatives provide loan equipment under the terms of this Kleenmaid Warranty.
9. Any unauthorised access to the internal hardware of the Product will void this Kleenmaid Warranty.

10. Repair Notice: Products presented for repair may be replaced by refurbished Products of the same type rather than being repaired. Refurbished parts may be used to repair the Products.
11. Replacement items are "like for like" and is not "new for old" and does not indicate in any way that a faulty Product will be replaced with a new part or unit. "Like for like" may either be a quality checked, refurbished or reconditioned unit of the same or later batch of model/size/specifications
12. The cost of making a claim under this Kleenmaid Warranty is not covered by Kleenmaid, including any costs of transportation or travel expenses between your home and your nearest authorised service agent.
13. Kleenmaid accepts no liability for items that are lost, damaged, or stolen as a result of freight, transport or storage. If you are required to transport the Product to an authorised service centre, you must ensure that it is securely packed and insured.
14. On Public Holidays or other periods when regular business and wholesale operations are temporarily ceased, repairer availability and warranty response times may extend beyond the standard response times due to the unavailability of repairers and parts.
15. For any repair performed on a Product under this Kleenmaid Warranty where no fault can be found, or the item is deemed by Kleenmaid or an authorised agent, to be not faulty under this Kleenmaid Warranty, or the repair or fault is not covered under this Kleenmaid Warranty, a 'No Fault Found' fee is payable by you. Kleenmaid will advise you of this cost and seek your agreement to pay such costs before commencing such repairs.
16. Any repairs or services required that are outside the terms and conditions of this Kleenmaid Warranty can be carried out at your request at your cost (including where the Product has not been installed or set up correctly). Kleenmaid will always advise you of this cost and seek your agreement to pay such costs before commencing such repairs. A credit card may be required prior to the commencement of such services.
17. Extra charges will be payable by the customer should the Product not be readily accessible without special equipment, such as but not limited to cranes and lifts or should the Product be installed in a position that service access is blocked and/or repair work is not possible without uninstalling the Product to gain access.
18. You, the customer, may be entitled to purchase an extended warranty in respect of the Product. Any extended warranty will not be issued by Kleenmaid but by a third party. Any extended warranty services will be provided directly by the third party as principal and not as agent for Kleenmaid, under their extended warranty terms and conditions and not under this Kleenmaid Warranty.
19. To make a claim under this Kleenmaid Warranty, please have your proof of purchase and the serial number of the Product ready and call (02) 9310 1207 during business hours.
20. This Kleenmaid Warranty is given by:
 - Name: Compass Capital Services Pty Ltd ABN 96 138 214 525 trading as Kleenmaid
 - Business address: Level 2, Suite 3, 204 Botany Rd, Alexandria NSW Australia 2015
 - Telephone: (02) 9310 1207
21. Definitions:
 - a. **Australian Consumer Law** means the *Competition and Consumer Act 2010* (Cth).
 - b. **Domestic Use** means use of the Product for personal, domestic or household purposes.
 - c. **Kleenmaid** means Compass Capital Services Pty Ltd ABN 96 138 214 525 trading as Kleenmaid.
 - d. **Mainland Australia** means the following States and Territories of Australia: New South Wales, Victoria, South Australia, Western Australia, Queensland, Tasmania, Northern Territory, Australian Capital Territory.
 - e. **Product** means the appliance sold by Kleenmaid to you as evidenced by the original purchase invoice.
 - f. **Warranty Period** means the period of 60 months for domestic use, 12 months for non-domestic use or such alternative period as may be specified.

UPDATE NOTICE: This Kleenmaid Warranty is current as at 1 January 2019 but is subject to variation from time to time. For the latest version of the Kleenmaid Warranty, please see our website <http://www.kleenmaid-appliances.com.au/support/your-kleenmaid-warranty> or phone us on (02) 9310 1207.

Other products available in the Kleenmaid range of appliances

- | Washing machines
- | Clothes dryers
- | Dishwashers
- | Ovens
- | Cooktops
- | Steam ovens
- | Microwave ovens Built in espresso coffee machines
- | Rangehoods
- | Freestanding ovens
- | Refrigerators & Freezers
- | Beverage Serving Cabinets
- | Water Dispensers Vacuum Cleaners

To register your warranty or make a warranty claim, scan this QR code:



Compass Capital Services Pty Limited
trading as Kleenmaid
ABN 96138214525

Level 2, 204 Botany Road Alexandria
NSW 2015



Register your Kleenmaid Appliances Warranty
www.kleenmaidwarranty.com.au



Request a Warranty Service
www.kleenmaidwarranty.com.au

E: support@kleenmaid.com.au
Please download the current User Manual for this appliance at www.kleenmaid.com.au

 **kleenmaid**