

cooking collection

Instructions for use and warranty details

To register your warranty or make a warranty claim, scan this QR code:



Induction Cooktop
Model: ICT9031

 **kLEENmaid**

Dear Customer,

Thank you and congratulations for choosing Kleenmaid.

Your new appliance has been designed and meticulously tested to ensure that it meets all your culinary requirements, and has been carefully manufactured using top quality materials to give you years of reliable performance.

For best results, carefully read the instructions on how your new appliance is to be installed. Correct installation will avoid delays and unnecessary service call costs.

Once installation is complete, please read this user manual carefully and get to know the controls and the features of your new Kleenmaid appliance. These simple instructions will enable you to achieve excellent results from the very first time you use it.

Again, congratulations and thank you for choosing The Best You Can Own.

KLEENMAID

GENERAL WARNINGS



Please read this instruction manual before installing and using the equipment. The manual must be kept together with the appliance for any future consultation. If the appliance should be sold or transferred to another person, ensure that the manual accompanies it, so that the new user will be informed of the operation and of the relevant warnings.

The product label, with the serial number, is attached to the cooktop base.



All operations relating to installation, adjustment and adaptation to the type of electric connection must be carried out by qualified personnel according to the regulations in force.

The specific instructions are described in the part of the manual reserved for the installer.



Declaration of Conformity:

we declare that our products comply with the European directives, orders and regulations as well as with the requirements indicated in the reference standards.

The manufacturer declines all responsibility in the event of damage to property or to persons resulting from improper installation or from improper, incorrect or unreasonable use of the appliance.

TABLE OF CONTENTS

I.	WARNINGS	
1.1	Premise	5
1.2	Product Label	5
1.3	Responsability of the Manufacturer	5
1.4	Precaution	5
1.5	Appliance Purpose	5
1.6	Damage to the appliance	6
1.7	Damage to persons	6
1.8	Disposal	7
2.	INSTALLATION - DIMENSIONS & WARNINGS	8
3.	INSTALLATION	
3.1	Electrical connection	10
3.2	General Information	10
3.3	Supply cable connection	12
3.4	Connection with plug and socket	12
3.5	For the Installer	12
3.6	Built-in cooktop installation	13
4.	INTRODUCTION TO INDUCTION COOKTOPS	16
5.	PRODUCT DESCRIPTION	19
6.	COOKTOP FUNCTIONS	21
6.1	Start cooking	22
6.2	Child lock	22
6.3	Key lock	22
6.4	Automatic Cooking function	23
6.5	Keep Warm function	24
6.6	Stand-alone timer	24
6.7	Cooking zone timer	25
6.8	Pause function	27
6.9	Recall function	28
6.10	Bridge function	28
6.11	Boost function	28

6.12	User menù	29
6.13	Chef function	31
6.14	Power management	32
7.	ERROR CODES AND SOLUTIONS	33
8.	CLEANING AND MAINTENANCE	34
9.	TECHNICAL SPECIFICATIONS	36
10.	DIRECTIVE 2012/19/EU	36

1.

WARNINGS

1.1 Premise

This user manual is an integral part of the appliance and must be kept intact and within reach of the user throughout the life of the appliance.

Please refer to the online version of this User Manual available on the Kleenmaid website (see back cover) for updates.

Before using the appliance read this user manual carefully.

1.2 Product label

The rating plate shows the technical data, the serial number and the marking. The rating plate must never be removed.

1.3 Responsibility of the manufacturer

The manufacturer declines all responsibility for damage to persons and property caused by:

- Use of the appliance other than that intended.
- Failure to comply with the instructions in the user manual.
- Tampering with even a single part of the appliance.
- The use of non-original spare parts.

1.4 Precautions

- **WARNING:** if the surface is cracked, switch off the appliance to avoid the possibility of electric shock.
- Pots and pans with a rough base could scratch the glass ceramic cooktop. Use only pots and pans with a smooth base.
- To move dishes it is always advisable to lift them. In this way the glass surface is not scratched.
- If spraying aerosols, slightly flammable

liquids or combustible materials, these can ignite. For this reason do not store flammable objects in the drawers directly under the cooktop. A plate drawer, if present, must be made of heat-resistant material.

- Do not heat empty pots or pans.
- When covering the cooktop, there is a danger that the cover material will ignite, shatter or melt if the ignition is switched on inadvertently or the residual heat is removed. Do not cover the cooktop, for example with cover plates, a cloth or protective film.
- If an electrical appliance is used in the immediate vicinity of the cooktop, e.g. a blender, make sure that the power supply cable does not come into contact with the cooktop. The insulation of the power cord may be damaged.
- If the cooktop has been recessed behind the door of a piece of furniture, put it into operation only with the unit door open. Close the unit door only when the residual heat indicator lights are off.
- The electromagnetic field of the active cooktop can influence the operation of magnetisable objects (credit cards etc).
- **CAUTION:** The cooking process has to be supervised. A short term cooking process has to be supervised continuously.

1.5 Appliance purpose

- This appliance is intended for the cooking of food in a domestic environment. Any other use is improper.
- The appliance is not designed to work with external timers or remote

WARNINGS

control systems.

- This cooktop is not intended for outdoor use.
- This cooktop is intended for use in the home.
- Do not use the cooktop in non-stationary locations (e.g. on ships).
- This appliance is not intended for use by persons (including children) with reduced physical, sensory or mental capabilities, or lack of experience and knowledge, unless they have been given supervision or instruction concerning use of the appliance by person responsible for their safety.
- To be used always within the limits of normal domestic use, NOT for professional use, to prepare and keep dishes warm. Any other use is NOT permitted.
- Persons who due to their physical, sensory or mental abilities or to their inexperience or lack of knowledge are not able to safely use the cooktop must not do so without the supervision and guidance of a responsible person.
- These persons may only use the device alone if it has been clearly explained to them how it works in order to use it safely. It is important that they know how to recognise and understand what dangers may derive from incorrect use of the appliance.

1.6 Damage to the appliance

- Do not modify the appliance.
- Never attempt to repair the appliance yourself or without the intervention of a qualified technician.
- Do not use harsh abrasive cleaners or sharp metal scrapers to clean the glass,

since they scratch the surface, which may result in shattering of the glass.

- Damage to the cooktop can put the safety of users at risk. Verify that there is no visible damage. Never operate a damaged appliance.
- **WARNING:** Unattended cooking on a cooktop with fat or oil can be dangerous and may result in a fire.
- **NEVER** try to extinguish a fire with water, but switch off the appliance and then cover flame e.g. with a lid or a fire blanket.
- Flames could ignite the grease filters of the rangehood. Do not prepare flambé dishes under the rangehood.
- Do not use the cooktop to prepare preserves or to heat cans. Cooking to prepare preserves or heating closed tins can result in bursting due to overpressure.
- Never use two pans on a single cooking zone.
- Do not heat empty pots or pans.
- If the supply cord is damaged, it must be replaced by the manufacturer, its service agent or similarly qualified persons in order to avoid a hazard.
- **WARNING:** Danger of fire - Do not store items on the cooking surfaces.
- A steam cleaner is not to be used.

1.7 Damage to persons

- **WARNING** for persons with pacemakers: bear in mind that an electromagnetic field is generated in the immediate vicinity of the device when it is operating. The possibility of pacemaker functioning being affected

WARNINGS

is very remote. If in doubt, contact the pacemaker manufacturer or your doctor.

- **WARNING:**The appliance and its accessible parts become hot during use. Care should be taken to avoid touching heating elements.
- Children should be supervised to ensure that they do not play with the appliance.
- Keep children away from the appliance until it has completely cooled down. In this way there is no risk of burns.
- Cleaning and user maintenance shall not be made by children without supervision.
- After use, switch off the cooktop element by its control and do not rely on the pan detector.
- The appliance in operation is very hot and also remains hot for some time after it has been switched off.
- Metallic objects such as knives, forks, spoons and lids should not be placed on the cooktop surface since they can get hot.
- Incorrectly performed repairs or installation and maintenance work can seriously endanger the user.
- Be sure the appliance is properly installed and earthed by a qualified technician.

This appliance does not contain substances in quantities such as to be considered hazardous to health and to the environment, in accordance with the current European directives.

To dispose to the appliance



Electrical voltage

Danger of electrocution

- Turn off the power supply from the electrical system.
- Disconnect the power supply cable from the electrical system.
- Cut the power supply cable and remove the cable together with the plug.
- Take the appliance to the appropriate waste collection centres for electrical and electronic waste.
- It should be noted that non-polluting and recyclable materials are used for packaging of the appliance.
- Give the packaging materials to the appropriate recycling centres.



Plastic packing

Danger of suffocation

- Do not leave the packaging or parts of it unattended.
- Children may play by wrapping themselves in the packaging material (e.g. in film) or wrap it around their heads, leading to danger of suffocation.

1.8 Disposal



This appliance must be disposed of separately from other waste (directives 2002/95/EC, 2002/96/EC, 2003/108/EC).

2. INSTALLATION - DIMENSIONS & WARNINGS

2. Built-in cooktop dimensions

- The worktop veneers must be prepared with a heat-resistant adhesive (100°C) so that they cannot detach or become deformed. The end wall profiles must be heat-resistant.

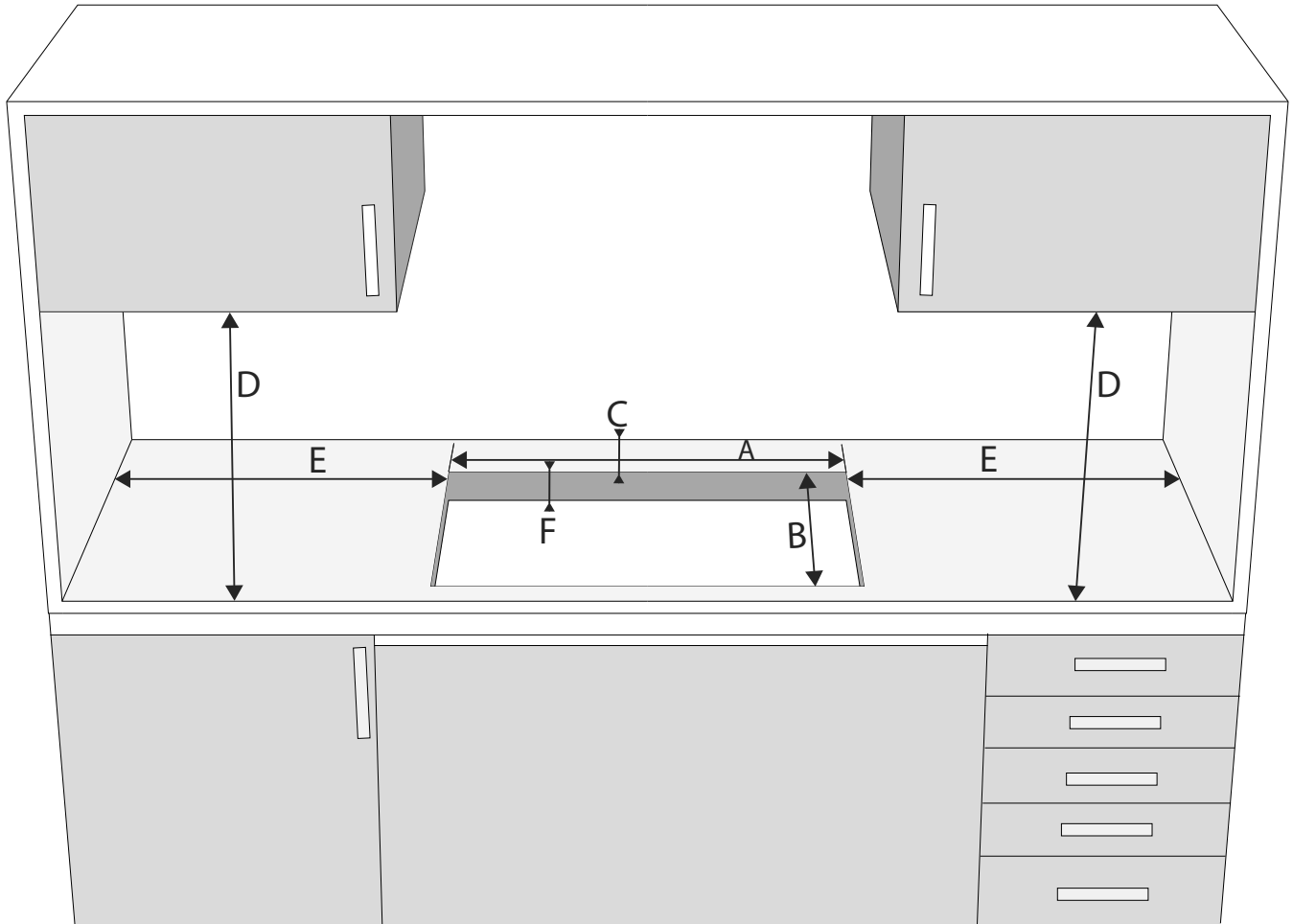

Dimensions :

Model	A (mm)	B (mm)	C (mm)	D (mm)	E (mm)	F (mm)
ICT903I	860	490	min 50	780	100	20-60

- Respect the minimum distance of 50 mm towards the rear wall and a minimum distance of 100 mm to the right or left towards a possible side wall.
- The safety gap between the cooktop and the rangehood placed above must comply with the recommendations of the rangehood manufacturer. In case of no instructions, a minimum distance of 650mm (or other minimum distance as may be specified by AS/NZS 5601 and interpreted by a certified installer) should apply.

3.

INSTALLATION

Installation Warnings

- Before making preparations for or commencing installation, the installer should refer to the current online version of the User Manual, which is available on the Kleenmaid website (see back cover for details).
- Make the notch in the worktop according to the dimensions relative to the model (see figure on page 8).
- Observe the minimum distance of 50 mm towards the rear wall and a minimum distance of 100 mm to the right or left towards a possible side wall.
- This cooktop complies with the current safety regulations. Improper use can cause damage to property and/or to persons.
- Read the operating instructions carefully before operating the cooktop as they contain important indications for installation, safety, use and maintenance of the appliance.
- Observing the operating instructions avoids dangers for persons and prevents damage to materials.
- Keep the user instructions and hand them over to any other users.
- The insulation of the fixed wiring supplying the appliance must be protected, for example, by an insulating sleeving having an appropriate temperature rating or the insulation of the fixed wiring supplying the appliance shall have an appropriate temperature rating.
- Metal objects stored in a drawer under the appliance may become very hot if the appliance is used for a prolonged period.
- Do not store metal objects in a drawer located directly below the cooktop.
- The cooktop cannot be recessed above a dishwasher, a tumble dryer, a washing machine, a refrigerator, a freezer, an oven or a cooker without a fan for cooling the appliance.
- Do not store small or pointed objects or paper in the drawer as these may enter the casing through the ventilation slots or they may be sucked in and thus damage the fan or impair cooling.
- If this appliance is not fitted with a supply cord or plug, the appliance must be fitted with means for disconnection from the supply mains having a contact separation in all poles that provide full disconnection under overvoltage category III conditions, and these means must be incorporated in the fixed wiring in accordance with the wiring rules of the country where the appliance is installed.

For Australia and New Zealand this means of disconnection shall be in accordance with AS/NZS 3000.

INSTALLATION

3.1 Electrical connection



Electrical voltage

Danger of electrocution

- Have the electrical connection carried out by qualified technical personnel.
- The earth connection is obligatory according to the methods foreseen by the safety regulations of the electrical system.
- Turn off the general power supply.
- The installation and connection of the appliance can only be carried out by a qualified electrician. Contact an electrician who is knowledgeable of the local rules and additional regulations issued by the local electricity operator and ensure that the work is carried out in compliance with the same. The manufacturer is not responsible for damage caused by incorrect installation or connection of the appliance. To prevent damage to the appliance, recess it only after installing the units and the rangehood.
- The electrical safety of the appliance is only guaranteed if it is connected to a compliant earthing conductor. It is very important to verify that this condition is fulfilled as it is a fundamental premise. If in doubt, have the system checked by a specialist technician. The manufacturer is not responsible for damage caused by the absence or interruption of the earthing conductor.
- Pay attention (conformity) to phase and neutral allocation of house connection and appliance (connection schemes); otherwise, components can be damaged. Warranty does not cover damage resulting from improper installation

3.2 General Information

- Check that the characteristics of the electrical network are suitable for the data shown on the rating plate.
- The rating plate, with technical data, serial number and marking is visibly positioned on the appliance.
- The appliance works with 220-240V or 380-415V, based of type connection.
- Provide for the earth connection with a cable longer than the others by at least 20mm.
- The necessary connection data is indicated on the rating plate and must correspond to that of the mains.
- Determine the various connection possibilities from the diagrams and table on page 11.

INSTALLATION

3.3 Supply cable connection

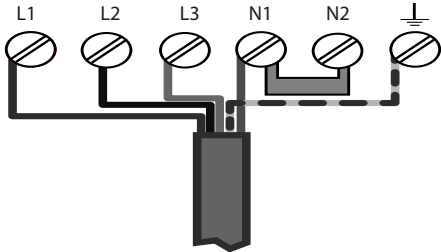
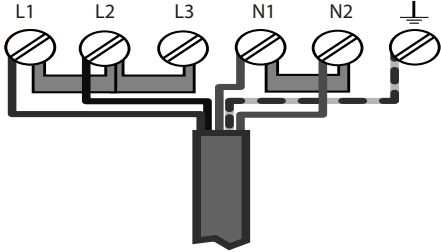
MODELS	RATINGS	CURRENT-SUPPLY CABLE	VOLTAGE CONNECTION	SUPPLY CABLE CONNECTION	
ICT903I	220-240/380-415V 2N; 50-60Hz; 11100W	24 A (x2) 5x2.5 mm ²	220-240V	TYPE 6	
		16 A 5x1.5mm ²	380-415V 2N	TYPE 4	
		TYPE 4		TYPE 6	
					



WARNING: IT MUST BE ENSURED THAT THIS APPLIANCE IS CONNECTED ONLY TO A 230vac or 400vac +10%/-6% 50Hz MAINS POWER SUPPLY WHICH CONTINUOUSLY COMPLIES WITH THE RELEVANT AUSTRALIAN STANDARD. FAILURE TO DO SO MAY SERIOUSLY DAMAGE THE APPLIANCE AND ANY SUCH DAMAGE IS NOT COVERED BY THE MANUFACTURER'S WARRANTY.



INSTALLATION

Fixed connection

- The interruption device must be located in an easily accessible position and near the appliance.

3.4 Connection with plug and socket

- Check that the plug and socket are of the same type.
- Avoid using reductions, adapters or shunts as they could cause heating or burning.
- A direct connection to the line is also possible. In this case it is necessary to interpose an omnipolar switch with a minimum contact opening of 3 mm, suitable for the load to be supported and in compliance with the regulations in force (the earthing conductor not to be interrupted by the circuit breaker).

3.5 For the installer

- The appliance must be installed according to the installation diagrams.
- The plug must remain accessible after installation. Do not bend or trap the connection cable to the mains.
- The appliance must not be connected to the mains with an extension cord; extensions do not guarantee the necessary safety of the appliance.
- Install this cooktop only on ovens or electric cookers equipped with a smoke cooling system.
- The worktop veneers must be prepared with a heat-resistant adhesive (100°C) so that they cannot detach or become deformed. The end wall profiles must be heat-resistant.
- For greater safety, it is advisable to include a circuit breaker with 30mA disconnection current.
- If there is a drawer under the appliance, do not store flammable objects in it (e.g. spray cans).
- Make sure that the connection cable to the cooktop electrical system is not subjected to mechanical stress after installation (e.g. due to a drawer).
- If the appliance does not function properly after all the checks are carried out, contact Kleenmaid Customer Support (see back cover for contact details).
- When the appliance is correctly installed, please instruct the user on the correct method of operation.

INSTALLATION

3.6 Built-in cooktop installation

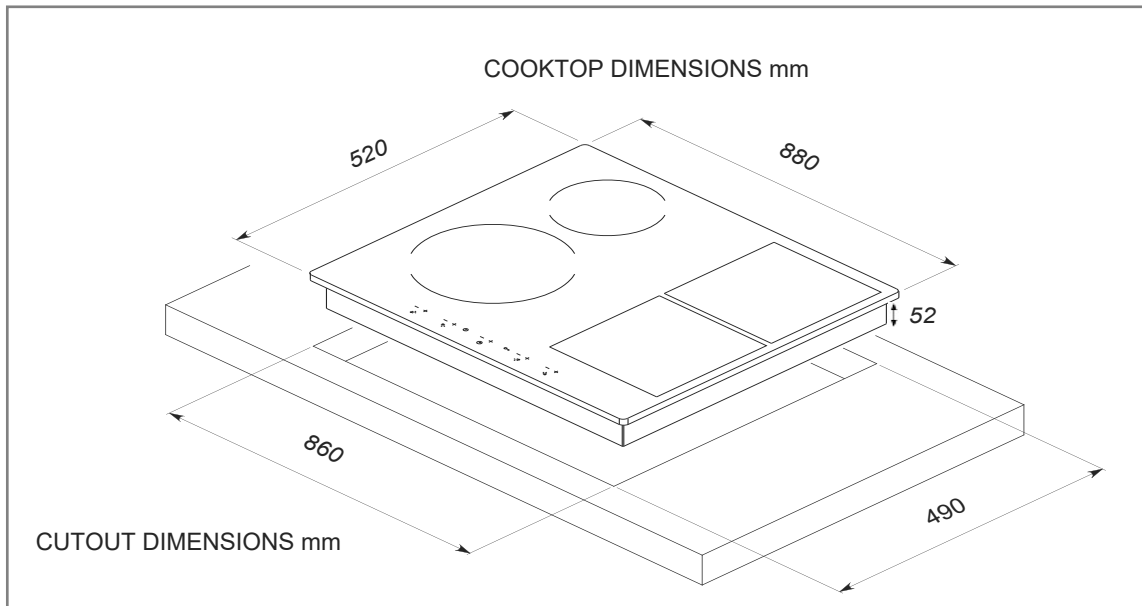

- Make the cutout in the worktop according to the dimensions in the figure above.
- Observe the minimum distance of 50 mm from the edge of the cutout towards the rear wall and a minimum distance of 100 mm to the right or left towards a possible side wall.

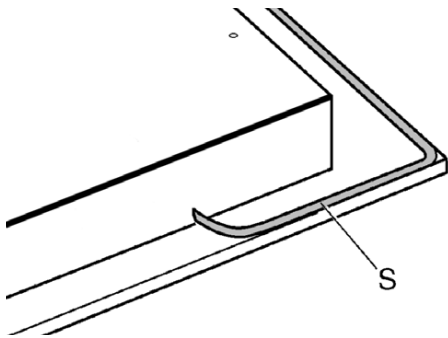

Turn the cooktop upside down and apply the foam sealing perimeter gasket S, (supplied with the accessories kit), evenly to the underside of the outside edge of the cooktop. See diagram at left.

- The safety gap between the cooktop and the rangehood placed above must comply with the recommendations of the rangehood manufacturer. In case of no instructions, a minimum distance of 650mm (or other minimum distance as may be specified by AS/NZS 5601 and interpreted by a certified installer) should apply.
- If flammable materials (eg a shelf) are located above the appliance the safety distance must be at least 760mm.
- If several appliances are installed under the rangehood, for different safety distances are envisaged, observe the greater safety distance indicated.

INSTALLATION

ATTENTION:

In order to ensure correct operation of the appliance, a gap of at least 10 mm must be left for the width of recessing on the front of the unit during installation.

This is because the electronic controls are equipped with a protection device which, when the temperature of the electronic part exceeds 85°C, turns off the cooktop until it returns below this limit. During operation a fan comes on to guarantee the necessary air flow to avoid exceeding the temperature limit. Therefore provide the installation with an underlying protection that in any case guarantees a flow of air from the back of the unit or, if the cooktop is installed above an oven, a type of insulation that is adequate to ensure that this temperature is not exceeded. In the case of over temperature, the electronic part may fail, for which the manufacturer's warranty will not apply.

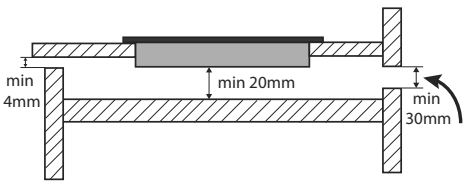

Fig. 1.

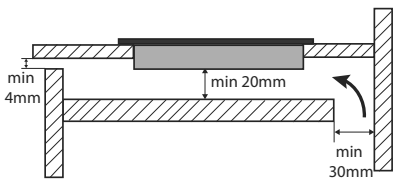

Fig. 2

Over Built-in oven

- If installed above an oven, a space (min 20mm) must be left between the bottom of the cooktop and the top of the appliance installed below.
- The clearance between the cooktop and the kitchen furniture or other installed appliances must be enough to ensure sufficient ventilation and air discharge.
- If installed on top of an oven, the latter must be equipped with a cooling fan.

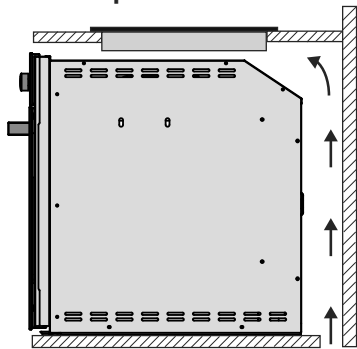

Fig. 3

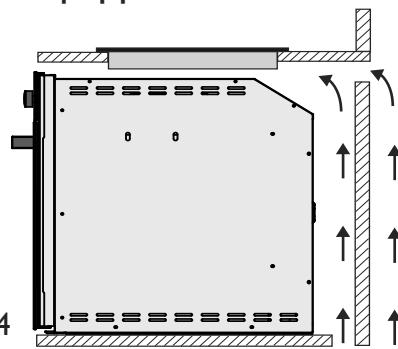

Fig. 4

Safety distance to the sides/rear wall

When recessing a cooktop, on the back and on the side (on the right or on the left) there should preferably be unit or room walls (see Fig. 3 and Fig. 4 above).

- 50mm minimum safety distance on the back from the cutout of the worktop to the rear edge of the same.
- 100mm minimum safety distance on the right and/or left side of the worktop cutout to the adjacent unit (eg column unit) or to the wall.

INSTALLATION

Intermediate shelf

The installation of an intermediate shelf under a cooktop is required if there is a drawer underneath.

To lay an electrical power cord, prepare a 10mm slot on the back.

It must only be possible to remove the intermediate shelf using suitable equipment or tools.

Failure to install the double-layer wooden base exposes the user to possible accidental contact with sharp or hot parts.

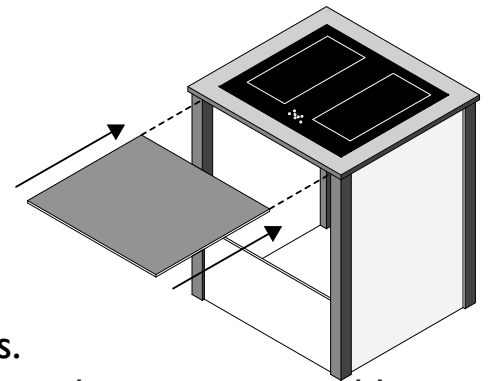

Downward safety distance

To guarantee correct ventilation, it is necessary to maintain a minimum distance between the appliance and an oven, an intermediate shelf or a drawer.

The minimum distance between the lower edge of the cooktop and

- the upper edge of an oven must be minimum 20mm;
- the upper edge of an intermediate shelf must be minimum 20mm;
- If you have a drawer under the cooktop, you must install an intermediate shelf between the cooktop and drawer.

Safety distance from the niche covering

If a covering is applied to the niche, a minimum distance must be observed between the worktop niche and the covering as high temperatures can damage or modify the materials.

If the covering is made of flammable material (e.g. wood), the minimum distance between the worktop and covering must be 50mm

If the covering is made of non-flammable material (e.g. metal, natural stone, ceramic tiles), the minimum distance between the worktop and covering notches must be 50mm less the thickness of the covering.

Example: covering thickness 15mm

50mm - 15mm = minimum distance 35mm

Differential switch (circuit breaker)

For greater safety, it is advisable to include a safety switch and circuit breaker with 30mA disconnection current, and in any case in accordance with the local regulations.

Separation devices

The device must be deactivated by means of disconnecting devices for each pole. (When the device is switched off, the contact opening must be at least 3mm). The disconnecting devices should include overcurrent protections and protection switches.

4. INTRODUCTION TO INDUCTION COOKTOPS

Practical tips for use of the appliance

- Use cooking containers whose manufacturing material is compatible with the principle of induction (ferromagnetic material). The use of these pots is recommended: cast iron, enamelled steel or special stainless steel for induction. To make sure that a container is compatible, simply test it with a magnet.

SUITABLE MATERIAL

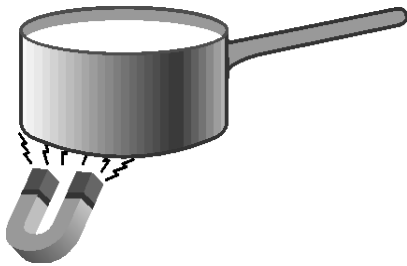

UNSUITABLE MATERIAL

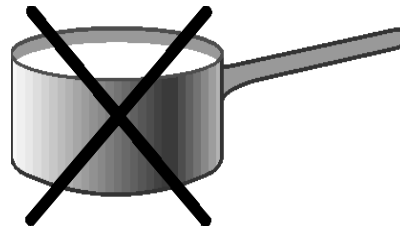

Cast iron, enamelled steel, special stainless steel with magnetic base

Copper, Aluminium, Glass, Terracotta, Ceramic, Non-magnetic stainless steel

In addition, to obtain the best performance from the cooktop:

- Use pots with a flat, thick base to ensure that they conform perfectly to the heating zone.
- Use pots of sufficient diameter to completely cover the heating zone in order to guarantee utilization of all the heat available.
- Ensure the base of the cookware is always perfectly dry and clean to guarantee correct conformance and durability, both to the cooking zones and to the pots themselves.
- Avoid using the same pans used on gas burners: the concentration of heat on gas burners can deform the base of the pot, which loses conformance.

CORRECT	INCORRECT

INTRODUCTION TO INDUCTION COOKTOPS

Arrangement of Pots

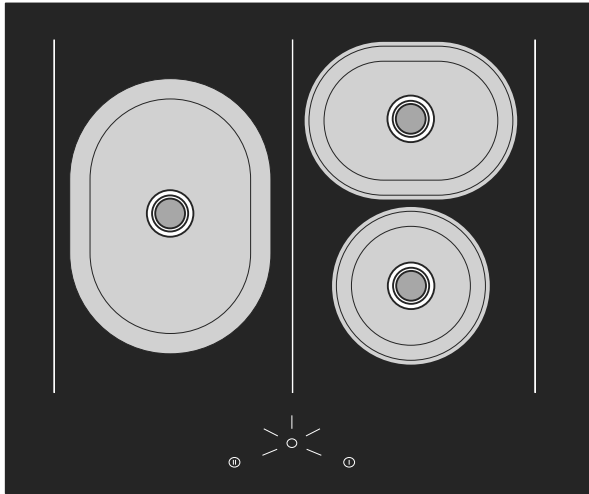

EXAMPLE OF CORRECT PAN POSITION

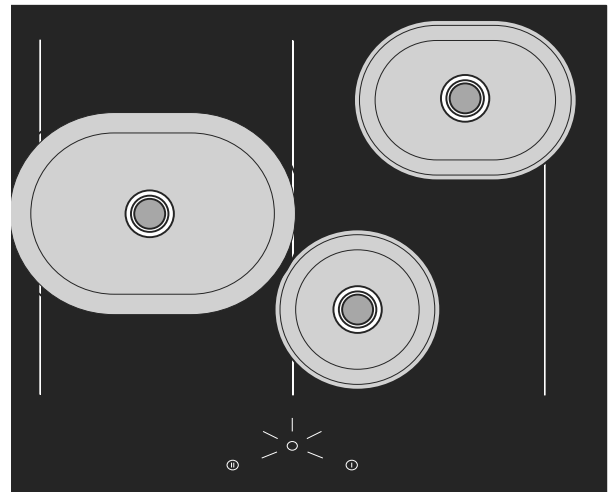

EXAMPLE OF INCORRECT PAN POSITION

If a large oval or oblong pan is used, ensure that it is positioned at the centre of the cooking zone.

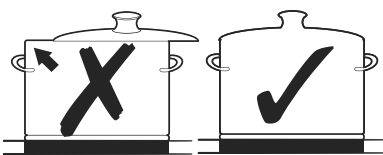
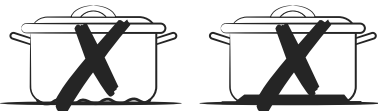

Energy saving tips

Follow these tips to save power consumption.

- Always put cookware on a cooking zone before you turn the corresponding burner on.
- Keep the cooking zones and cookware bases clean, otherwise more power will be consumed.
- Firmly close the lid on cookware if available. This will reduce power consumption.
- Turn the operating burner off before the end of the cooking time. Use the residual heat to keep food warm.



THE USE OF EITHER POOR QUALITY POT OR ANY INDUCTION ADAPTOR PLATE FOR NON-MAGNETIC COOKWARE RESULTS IN A WARRANTY BREACH. IN THIS CASE, THE MANUFACTURER CANNOT BE HELD RESPONSIBLE FOR ANY DAMAGE CAUSED TO THE HOB AND/OR ITS ENVIRONMENT.



INTRODUCTION TO INDUCTION COOKTOPS

Using the touch buttons

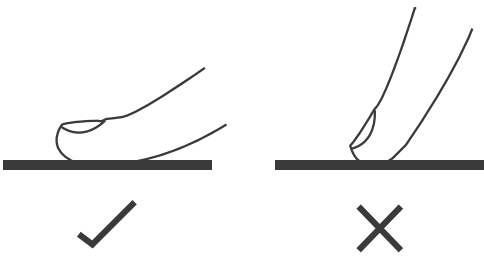

To operate the touch buttons, touch the desired button with the ball of your pointed finger until the relevant displays illuminate or go out, or until the desired function is activated.

Ensure that you are touching only one button when operating the appliance. If your finger is too flat on the button, an adjacent button may be actuated as well.

First commissioning

- Remove any protective and adhesive films.
- Before starting the appliance for the first time, clean it with a damp cloth and dry it.
- The metal components have been treated with a special protective product. When first used the appliance may emit odours and possibly steam. Even with the heating of the induction coils, odours may be given off during the first few hours of operation. With further use the odour fades until it disappears completely.
- Odours and any fumes are not symptomatic of incorrect connection or damage to the appliance and are not harmful to health.

INTRODUCTION TO INDUCTION COOKTOPS

Additional Safety Features

Automatic switch off

Operation time limitation is a safety feature to turn OFF a cooking zone when the user hasn't operated the corresponding cooking zone after a specific time. The time after which the cooking zone is turned OFF is indicated in the table below. Each user operation related to the cooking zone will reset this time limit.

<i>COOKING LEVEL</i>	<i>MAXIMUM OPERATION TIME (MIN)</i>
Warming	480
1	516
2	402
3	318
4	258
5	210
6	138
7	138
8	108
9	90
P	5

Residual Heat Indication

Residual Heat Indication is a safety feature to indicate that the surface of the glass on top of a cooking zone still at a temperature ≥ 60 °C which may cause burns when touched with bare hands. The 7-segments of the corresponding cooking zone display an H in this case .

An interruption of the power supply voltage cancels the residual heat indication, even if the temperature of a cooking zone is still ≥ 60 °C when the cooktop is re-powered.

Overheating

The cooktop is designed to have a maximum internal operating temperature of 85 °C. The operating temperature is monitored by an internal temperature sensor. If the internal temperature exceeds 85 °C, the whole cooktop will turn off and the error code ER21 will be displayed.

Monitoring of Prolonged Key Activation

The cooktop is monitored for prolonged key activation. If a cooktop key is touched for more than 10 secs, the cooktop will go to OFF mode, emit an audible signal tone for 10 secs and display error code ER03 as long as the prolonged key activation continues.

As soon as the prolonged key activation ceases, the cooktop can be operated regularly.

5.

PRODUCT DESCRIPTION

ICT903 I

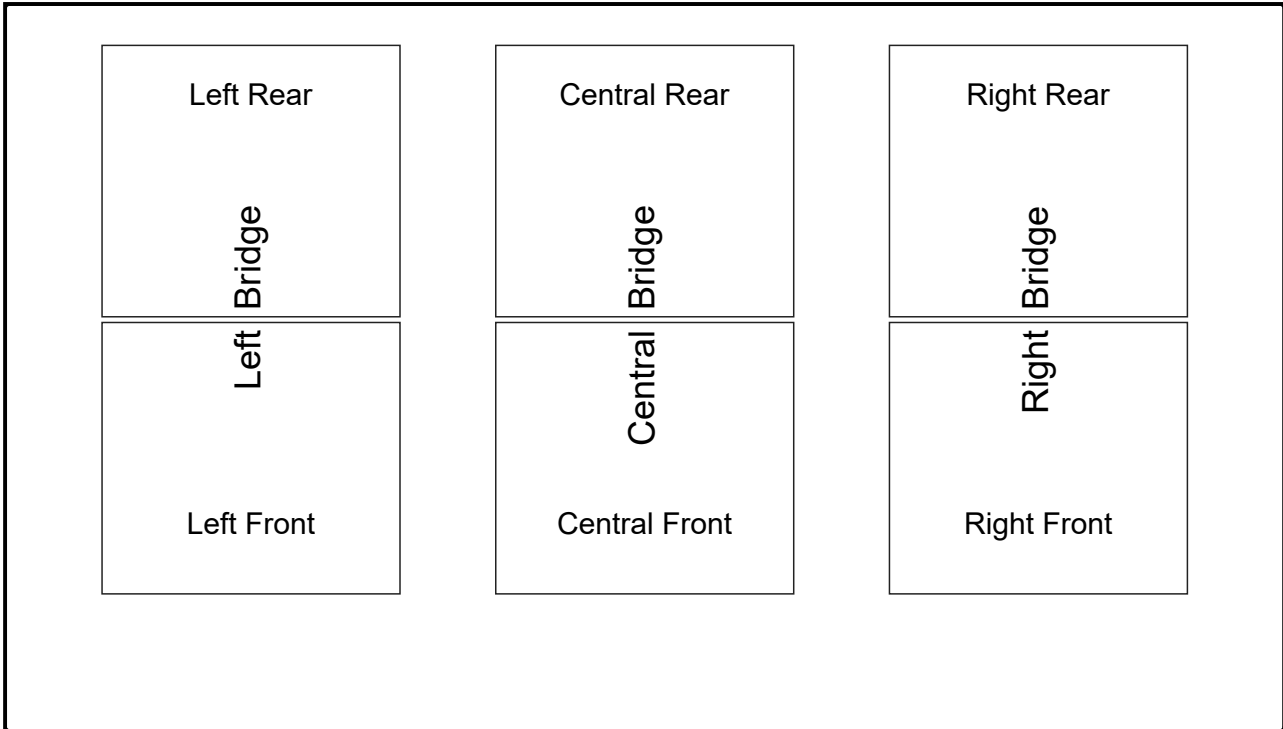

Absorbed Power for Cooking Zones

Cooking zone	Absorbed Power	Absorbed Power with Bridge Function
Left Front	220mm x 180mm 2100W-3000W	-
Left Rear	220mm x 180mm 2100W-3000W	-
Left Bridge	-	3000W-3700W
Central Front	220mm x 180mm 2100W-3000W	-
Central Rear	220mm x 180mm 2100W-3000W	-
Central Bridge	-	3000W-3700W
Right Front	220mm x 180mm 2100W-3000W	-
Right Rear	220mm x 180mm 2100W-3000W	-
Right Bridge	-	3000W-3700W

6.

COOKTOP FUNCTIONS

Control Panel

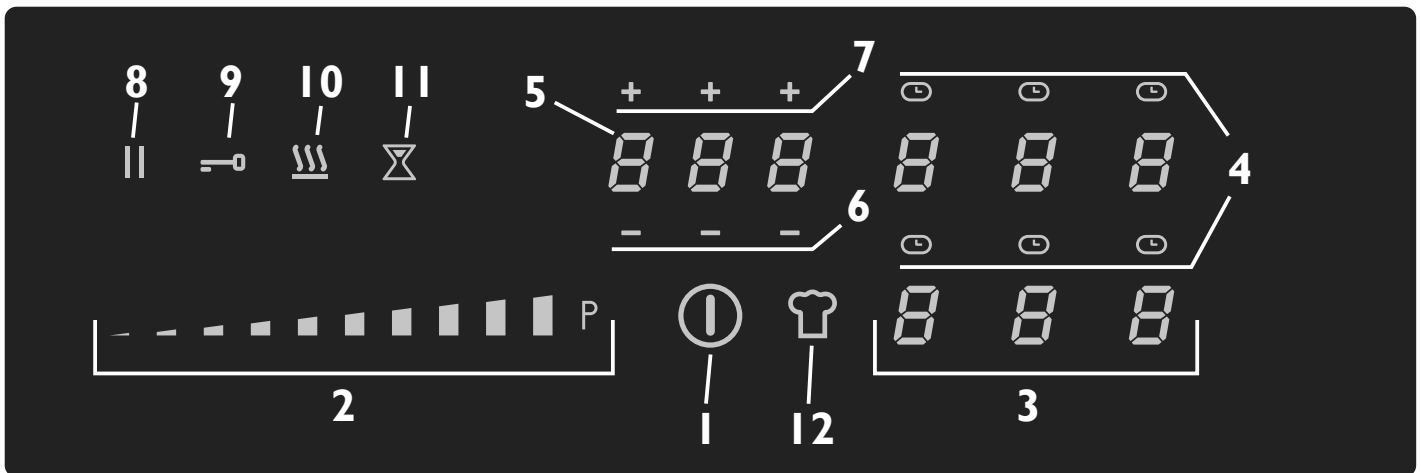

Sensors key

- 1 On/Off
- 2 Power level setting range with slide bargraph
- 3 Cooking zone selection and power level display
- 4 Timer active indicators
- 5 Timer display
- 6 Timer level decrement
- 7 Timer level increment
- 8 Pause-Recall Function Smart Key
- 9 Key-Lock Function Smart Key
- 10 Keep Warm Function Smart Key
- 11 Stand-alone Timer
- 12 Chef Function Smart Key

COOKTOP FUNCTIONS

6.1 START COOKING

Turn on the cooktop by touching the ON/OFF key, then place the pan in the desired area and the corresponding display will automatically light up on the control panel. Choose the power level with the slider.

6.2 CHILD LOCK

Child lock is a functionality to protect the cooktop against unintended operation, e.g. by children. If locked, the cooktop may be turned ON, but no cooking zone, heating level or timer may be selected. The displays for the cooking zones will show .

Child lock stays active even if the power supply voltage is interrupted and recovered. It has to be de-activated manually (see section below, De-activation of Child Lock).

Preparation

- Cooktop is switched OFF.

Activation

- Power the cooktop ON.
- Touch and hold an arbitrary cooking zone for 3 sec. then release it.
- The slider area shows a chaser sequence.
- Slide the slider from 0 to 9 within 10 seconds .

- The child-lock is activated. All cooking zones show an .

De-activation

- Press an arbitrary cooking zone for 3 sec. then release it.
- The slider area show a chaser sequence.
- Slide the slider from 9 to 0 within 10 seconds.
- The child-lock is de-activated.

6.3 KEY LOCK

Key lock is a functionality intended to lock the keys when the cooktop is in operation or in pause state. This is useful for cleaning purposes (as the touch control is unable to differentiate a wet cloth from a finger).

Activation

- Press special key .

De-activation

- Press special key again .

COOKTOP FUNCTIONS

6.4 AUTOMATIC COOKING

Automatic Cooking is a feature which enables heating up a cold pot with full heating power then returning automatically to a desired cooking level.

The time the cooking zone is heated with full power depends on the selected cooking level. See the table below.

The Automatic Cooking times are adapted to be used with cold cookware and common household quantity of food.

COOKING LEVEL	AUTOMATIC COOKING TIME (SEC)
1	48
2	144
3	230
4	312
5	408
6	120
7	168
8	216
9	not available
P	not available

Preparation

Cookware is placed on a cooking zone. Cooktop is ON and a cooking level between 1 and 8 has been selected for the cooking zone.

Activation

- Select the corresponding cooking zone.

The slider area is lighted and the selected cooking zone shows a  beneath the cooking level.

- Touch and hold the desired cooking level (1-8) and hold the selection for 3 secs. Automatic cooking is activated. The Smart Key of the corresponding cooking zone displays .

Notes

- It is possible to increase the power level while Automatic cooking is active.
- Decreasing the power level while Automatic cooking is active will deactivate the Automatic cooking function immediately.

De-Activation

- Touch and hold the Cooking Zone Smart Key for 3 secs. Automatic cooking is de-activated. The cooking zone is heated with the previously set cooking level.

COOKTOP FUNCTIONS



6.5 KEEP WARM FUNCTION

The Keep Warm function is intended to keep cooked food warm.

Preparation

Cookware is placed on cooking zone. Cooktop is switched ON.

Activation

- Select the cooking zone
- A dot () appears behind the cooking zone display to indicate the selection.
- Press the Keep Warm Function key, the corresponding cooking zone display shows 

De-activation

- Select the cooking zone.
- A dot () appear behind the cooking zone display to indicate the selection.
- Press Keep Warm Function Smart key.

TIMERS

There are 2 different types of timers which are explained in detail below.

6.6 STAND-ALONE TIMER

Stand-alone timer has the behavior of an egg timer.

It can be set within a range of 1 min to 9 h 59 min. Under 10 min, the display shows the remaining time, accurate to the second.

After the set time has run out, a signal tone will sound.

If stand-alone timer is running, the cooking zones can be operated normally.

Stand-alone timer has no effect on any cooking zone.

Preparation

Cooktop is switched ON.

- Ensure that no cooking zone has been selected. The timer display will show .

Activation

- Touch the timer display.
The timer display  will flash for the next 10 secs.
- Adjust the desired start time digit for digit with +/- above/beyond the digits.
- Do not perform any action for 10 secs.
The timer starts counting backwards. Under 10 min, the display shows the current time accurate to the second. If it has reached 0, a signal tone will be emitted.

Note The timer selection is kept for 10 secs after the last action. Each change resets the selection time back to 10 secs.

COOKTOP FUNCTIONS

Changing the value of the stand-alone timer

Cooktop is switched ON.

- Ensure that no cooking zone has been selected.
- Touch the timer display.

The current time value flashes on the timer display (rounded to full minutes).

- Set the new desired time digit with +/- buttons.
- Do not perform any action for 10 secs.

The timer starts counting backwards starting with the new time. Under 10 min, the display shows the current time accurate to the second. If it has reached 0, a signal tone will be emitted .

Note The timer selection is kept for 10 secs after the last action. Each change resets the selection time back to 10 secs.

De-activation

- Ensure that no cooking zone has been selected.
- Touch the timer display.

The current time value is displayed flashing (rounded to full minutes).

- Set the Stand-alone time to **000** as described above.

The stand-alone timer is deactivated.

6.7 COOKING ZONE TIMER

Cooking zone timers can be used to switch a cooking zone OFF automatically after the set time has run out. It can be adjusted within a range of 1 min to 1 h 59 min. Under 10 min, the display shows the current time accurate to the second. While the timer is running, the cooking zone can be operated normally, i. e. changing the cooking level is possible.

Each cooking zone has an independent timer, i. e. an individual time selection per cooking zone is possible. If more than one timer is set, the timer will always display the lowest remaining time.

COOKTOP FUNCTIONS

Preparation

A pot is placed on the corresponding zone and a cooking level has been set to this cooking zone .

Activation

- Select the corresponding cooking zone .

The display of the cooking zone shows a dot () in addition to the select cooking level.

- Touch the timer display which will flash for the next 10 secs. 
- Adjust the desired start time digit for digit with +/- .
- Do not perform any action for 10 secs.

The timer starts counting backwards and the indicator for the corresponding cooking zone starts pulsating. If it has reached 0, a signal tone will be emitted; the timer display will show  and the corresponding cooking zone will be turned OFF.

If the residual heat detection detects a hot cooking zone, an  will be displayed at the corresponding cooking zone.

- Touch any button to disable the signal tone.

The signal tone stops and the cooktop can be operated normally. If no key is activated, the signal tone will stop automatically.

Notes

- The timer selection is kept for 10 secs after the last action.
- Each change resets the selection time back to 10 secs.
- If a cooking zone with a running cooking zone timer is selected, the current value of the timer is displayed on the timer display.
- A timer set for a cooking zone is indicated by the corresponding active indicator above the cooking zone.
- If more than 1 cooking zone timer is set, the timer value for the lowest time period running is displayed on the timer display. Additionally, the active indicator for this cooking zone timer will be flashing.

COOKTOP FUNCTIONS

Changing the value of the cooking zone timers

Cooktop is switched ON .Timer for cooking zone is active.

- Select the corresponding cooking zone.
- Touch the timer display.

The current time value flashes on the timer display (rounded to full minutes).

- Set the new desired time digit for digit with +/- display above/beyond the digits.
Do not perform any action for 10 secs.

The timer starts counting backwards starting with the new time. Under 10min, the display shows the current time accurate to the second . If it has reached 0, a signal tone will be emitted.

Note: The timer selection is kept for 10 secs. after the last action . Each change resets the selection time back to 10 secs.

De-activation

- Set the cooking zone time to **0.00** as described above.

6.8 PAUSE FUNCTION

Pause function is a feature to “freeze” the cooktop for max. 10 min e. g. if the user is leaving the cooktop for a short period of time. While the pause function is active

- no cooking zone will heat the cookware.
- all timers (including egg timer) will be paused.
- **Boost and Automatic Cooking functions will be paused.**

Note Pause function has no influence on operation of time limitation and display of residual heat.

If paused state lasts longer than 10 min, the cooktop will switch OFF.

Activation

Cooktop is switched ON and at least one cooking has a cooking level > 0.

- Touch and hold the Pause button for 1 sec.

All 7-segment displays for the cooking zones show **⏸**.

The pause function is active.

De-Activation

- Touch and hold the Pause for 1 sec.

The symbol on the Pause starts flashing.

- Touch any arbitrary cooking zone within the next 10 secs.

The pause function is terminated and the cooktop will continue with all actions set before.

COOKTOP FUNCTIONS

6.9 RECALL FUNCTION

Recall function is a feature which enables the recovery of power levels and timer settings after the cooktop has been switched OFF unintendedly. Within 6 secs of powering off the cooktop, all former settings (power levels, timers, automatic cooking) can be recovered by using this function.

If the cooktop is turned OFF and ON again during the 6 secs, all former settings (power levels, timers, automatic cooking) will be recovered automatically. Recall feature cannot be disabled by the user via the User Menu.

Activation

Cooktop has just been switched off.

- Switch the cooktop ON again via the ON/OFF.

The Pause will flash for 6 secs.

- Touch the Pause.

The Recall function becomes active. All power levels, timers and automatic cooking functions set before will be recovered.

6.10 BRIDGE FUNCTION

Bridging of 2 cooking zones is the connection of 2 single cooking zones, so they can be controlled and will behave as one large cooking zone. This is possible only in the adjacent rectangular zones, marked with the carbon fibre background, and enables using cookware which has a larger bottom surface than a single cooking zone. See bridgeable zones diagram page 20.

Activation

- Touch both cooking zone Smart Keys simultaneously on the display.

The cooking zones are bridged. This is shown by the symbol .

De-activation

- Touch both cooking zone Smart Keys simultaneously.

The cooking zones are split into 2 separate zones again.

The  symbol disappears.

6.11 BOOST FUNCTION

Boost enables the cooktop to heat at a higher power level for a cooking zone than its normal power for a short period of time (5 minutes). This is useful to heat-up/boil a great amount of water.

Note: As the Boost function may reach high temperatures, it must only be used for cooking processes using water. Oil or fat may start to burn if Boost is used.

Activation

Select the cooking zone a dot () will appear behind the current cooking level to indicate the selection.

Tap the P symbol on the slider area. Boost for the selected cooking zone is activated. The display for the cooking zone shows a P.

COOKTOP FUNCTIONS

De-activation

Select a cooking level for the cooking zone for which Boost is currently active. The boost function is terminated and the cooking zone heats with the new selected power level. Note: Boost function is de-activated automatically after 5 min.

6.12 USER MENU

User menu is designed for the user to adapt the touch controls to their personal needs.

Entering the user menu

The cooktop is in standby mode.

- Touch ON/OFF to power up the Touch Control. Touch the ON/OFF again within 3 secs to set the Touch Control to standby mode again. The four special function keys, top left on the Touch Control, start pulsating (for 60 secs max).
 - Press and hold down the pulsating Pause key.
 - Press all cooking zone selection keys in clockwise direction, starting with the left front cooking zone. See diagram below. Each key press will be acknowledged by an acoustic signal (beep). Release Pause.
- Skip cooking zone selection which is not available.

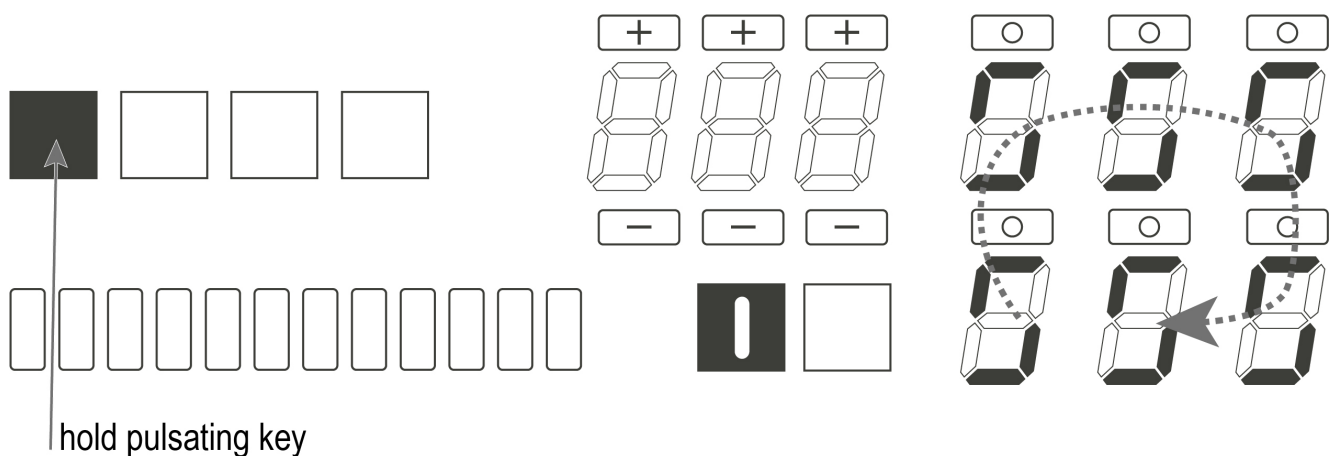

The user menu is active. The display shows **88** in the display for the rear left cooking zone.

Select and changing menu

- Enter the user menu as described above in "entering the user menu".
- Select the menu item which you want to display/change via the slider. The value for the selected item is displayed on the display for the left front cooking zone.
- To change the menu item's value, select the menu item by touching on the displayed menu item. The selected menu item is displayed by a .
- Choose the menu item's value by the slider via direct selection (sliding is not possible).

Note Only valid values can be entered by the slider keys, i.e. undefined values will not be accepted during selection.

COOKTOP FUNCTIONS

Exiting the User Menu

- Touch the Pause key. The service menu will be exited. All changes will be dropped.
- Touch the Power key for 2 seconds. The service menu will be exited. The changes will be saved.

User Menu Items Overview

The table below provides an overview about the implemented user menu items:

ITEM	MEANING	CHANGE -ABLE ?	VALUE FORMAT	REMARK
U0	Max. power per line conductor	Yes	2.4 ... 5	Setting the max. allowed power per line conductor. The max. power is defined inside the service menu and can only be reduced in steps of 0.1 Kw until the minimum power.
U1	Filter setting	Yes	0,1,2	Filter changes: 0-150h (default) 1-300h 2-400h
U2	Volume for button tones	YES	2.4 ... 5	Adjustment of the volume for button tones 0:no button tones 1:min.volume 2:mid.volume 3:max. volume Notes: Due to safety regulations, button tones for switching ON and OFF cannot be disabled. They will be emitted with last volume level which has been set before disabling the button tones. Tones for errors are always emitted with max. volume (setting and cannot be disabled).
U3	Volume for signal tones	YES	0...3	Adjustment of the volume for signal tones (e.g. when timer runs out) 0: min.volume ... 3: max.volume

COOKTOP FUNCTIONS

U4	Display brightness	YES	0...9	Adjustment of the brightness for the display 0: Max. brightness 9: Min. brightness
U5	Timer animation	YES	0...1	0: No Timer animation 1: Timer is animated during the last 59s before 0
U7	Behavior when timer has run out	YES	0...2	0: Signal tone for 120s 1: Signal tone for 10s 2: No tone

6.13 CHEF FUNCTION

Chef Function is a feature which enables cooking zones to be pre-set with different heating power levels. Starting from left to right, the following power levels are set and delivered as soon as a suitable cookware is placed onto the each cooking zone:

- Left cooking zone(s): 2
- Middle cooking zones(s): 6
- Right cooking zone(s): 9

Activation

Cooktop is switched ON.

- Touch the Chef Function Smart Key.
- The Chef mode is activated. The displays for the cooking zones show the bridge symbols and the set power levels (2, 6 and 9) from left to right.

De-activation

- Touch the Chef Function Smart Key.
- The Chef mode is de-activated. The power levels for all cooking zones are set to 0.

COOKTOP FUNCTIONS

6.14 POWER MANAGEMENT

The cooktop is designed to have a power limitation to protect from overload, so it is possible that not all the cooking zones may reach the maximum power level at the same time. You may see the cooking level indicator flash for 3 seconds when you turn on a second cooking zone. This shows that the power management system is prioritizing, i.e. the cooking zone where the heating power has been increased last will get the desired heating power and the heating power for other cooking zone connected to the same line conductor will be reduced. Power management does not activate if the two cooking zones in use are on different sides of the cooktop i.e. left and right sides.

Here's an example of how Power Management technology works :

Cooking zone 1 (first zone turned on) has a max. power of eg. 2.3 Kw. Cooking zone 2 (second zone turned on) has a max. power of eg. 1.8 Kw. Both cooking zones are connected to the same line conductor.

An overload of the line conductor (4.1Kw) would be caused by both cooking zones operating with their max. power.

- Put a pot on cooking zone 1 and set cooking level to 9.
- The pot on cooking zone 1 will be heated with 2.3 Kw.
- Put another pot on cooking zone 2 and set cooking level to 9. The pot on cooking zone 2 will not be powered immediately. The cooking level for zone 1 flashes for 3 sec to show that the heating power for cooking zone 1 will be reduced. After 3 sec, the heating power of cooking zone 1 will be reduced to level 7 (1.8Kw) and cooking zone 2 will be powered with 1.8 Kw. The total power consumption of both cooking zones will be <3.7 Kw.

For safety reasons, the power of the cooking zone which has been reduced (cooking zone 1) by the power management system is not increased to its former power level again. During the flashing of cooking level 1 indicator, the user has the chance to set a lower cooking level to avoid power reduction to the cooking zone. If the new cooking level chosen would still cause an overload, the flashing time of 3 sec will restart and another level can be set.

7. ERROR CODES AND SOLUTIONS

ERROR HANDLING

An error code always starts with the letters “E” or “ER” depending on the electronic component which has generated the error:

- Error codes starting with “ER...” are detected directly by the Touch Control.
- Error codes starting with “E...” only are sent by the induction generator.

Refer to the table below for possible causes and remedies.

Error code	Meaning	Possible Causes	Remedy
ER03	Continuous key activation detected	Water or cookware placed on the control	Remove water or cookware from the glass
ER20	Internal error	-	* Replace the control
ER21	Over temperature	Temperature sensor on the cooktop have detected a temperature >85°C	Let the cooktop cool down (error disappears if temperature is < 75°C). *Check heat insulation of the touch control
ER22	Internal error	The configuration date inside the induction generator is different from the configuration inside the electronic control	*Replace the touch control
ER31	Configurations inside Touch Control and induction are incongruent	The configuration data inside the induction generator is different from the configuration inside the touch control	*Download configuration. If error is still occurring, replace the touch control. *If error is still occurring, replace the induction generator.
ER36	Internal error inside the Touch Control	-	*Replace the touch control
ER42	Secondary power supply voltage(s) invalid	12V or 5V too high / too low	*Contact technical support
ER47	No communication		*Check and replace LIN cabling. *Check power supply voltage. *Replace LIN subscriber
3 sec flashing of zone cooking level indicator when 2nd zone turned on	Power Management Function activated	This is normal	See Power Management on p32 of User Manual

(*) For this type of problem contact technical support. When requesting a service call please note your model no (ICT9031) and the individual serial number which is on the rating plate on the base of the cooktop.

8. CLEANING AND MAINTENANCE

CLEANING AND MAINTENANCE

- NEVER use a steam appliance to clean a cooktop.
- Steam from a steam cleaning appliance can reach voltage conductive parts and cause a short circuit.
- Do not spill sugar or sweet mixtures on the cooktop during cooking.
- Keep sensor keys clean at all times and do not rest any object on them.
- Always clean the cooktop after each use. Before doing so, allow it to cool completely.
- After cleaning, dry the appliance to avoid scale deposits.
- To avoid damaging the surfaces, DO NOT use the following cleaning products:
 - Washing-up liquid
 - Detergents containing soda, ammonia, acids or chlorides
 - Anti-scale products
 - Products to eliminate stains and rust
 - Abrasive detergents, e.g. abrasive creams or powders, cleaning pastes, solvents
 - Dishwasher detergents
 - Sprays for grills and ovens
 - Glass cleaners
 - Abrasive brushes and sponges such as scourers or sponges that still contain residues of abrasive detergents
 - Dirt removing rubber
 - Sharp objects (to avoid damaging the seal between the glass ceramic plate and the frame or between the frame and the worktop)
- If the appliance is installed on an oven or an electric stove equipped with a pyrolytic system, **do not operate it** while the pyrolytic system is in progress as it may trigger the overheating protecting device of the cooktop.

If there are food residues on the glass surface they can be removed using a special scraper suitable for induction cooktops.

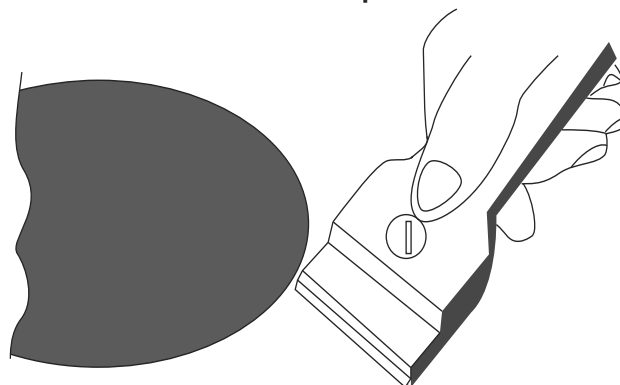

CLEANING AND MAINTENANCE

For cleaning DO NOT use dishwashing detergent.

- With dishwashing detergent it is not possible to eliminate all residues and deposits.
- An invisible film is created which discolours the glass ceramic.
- These discolourations are then impossible to remove.

Clean the cooktop regularly with a specific glass ceramic detergent. Remove the largest pieces of dirt with a damp cloth;

Clean the surface of the cooktop with a suitable ceramic glass cleaner using kitchen paper or a clean cloth.

Finally, wipe the surface with a damp cloth and dry it.

In subsequent cooking procedures, the residues may adhere to the surface and damage the glass ceramic.

Carefully remove all detergent residues.

Stains due to calcareous residues, water and aluminium residues (spots with metallic reflections) can be eliminated by using a specific glass ceramic and stainless steel cleaner!!

Danger burns!!

Wear oven gloves before removing any residues of sugar, plastic or aluminium foil with a spatula from the hot cooktop.

Immediately turn off the cooktop if sugar, plastic or aluminium foil are found on it while it is still hot.

Carefully use a spatula to remove these substances from the cooktop while they are still hot.

Clean the cooking zone when cold as described above.

9. TECHNICAL SPECIFICATIONS

Cooking Zones	9 cooking zone options
Supply Voltage	See 3.3 Supply cable connection page 11
Current Rating	24A (x2) 1P/16A 2P
Total Power	11100W
Product Dimensions LxWxH mm	520*880*52
Building-in dimensions AxB mm	860*490
Standby Power Consumption	<1W

10. DIRECTIVE 2012/19/EU

This product complies with Directive 2012/19/EU

The crossed bin symbol on the appliance indicates that the product, at the end of its useful life, needing to be treated separately from household waste, must be sent to a separate collection centre for electrical and electronic equipment.



The user is responsible for taking the appliance at the end of its life to the appropriate collection facilities, otherwise incurring the penalties provided for by the current waste legislation.

Adequate separate collection for future use of the equipment assigned for recycling, treatment and environmentally compatible disposal helps to prevent possible negative effects on the environment and on human health and promotes recycling of the materials that compose the product.

For more detailed information regarding the collection systems available, contact the local Council or waste disposal service .

The manufacturer declines all responsibility for possible inaccuracies due to printing or transcription errors contained in this manual. It reserves the right to make all the modifications it deems appropriate to its products without compromising the essential characteristics of functionality and safety.

KLEENMAID WARRANTY

TERMS AND CONDITIONS

1. Compass Capital Services Pty Ltd ABN 96 138 214 525 trading as Kleenmaid will provide parts and labour to you the customer as set out herein.
2. Kleenmaid may engage a Service Agent to provide service under this warranty.
3. Kleenmaid's Products come with guarantees that cannot be excluded under the Australian Consumer Law. You are entitled to a replacement or refund for a major failure and for compensation for any other reasonably foreseeable loss or damage. You are also entitled to have the goods repaired or replaced if the goods fail to be of acceptable quality and the failure does not amount to a major failure.
4. The benefits given to you under this Kleenmaid Warranty are in addition to other rights and remedies to which you may be entitled under the Australian Consumer Law in relation to the Product to which this Kleenmaid Warranty relates. Subject to the conditions below, the Product is warranted by Kleenmaid and/or its agents to be free from defects in materials and workmanship for the Warranty Period for normal Domestic Use.
5. Product Identification: -
 - a. Kleenmaid reserves the right to reject claims for any services or work where you cannot produce for verification the serial number and a proof of purchase for the Product (including but not limited to the original invoice).
 - b. this Kleenmaid Warranty will be voided if the serial number for the Product cannot be verified. This is not intended to exclude, restrict or modify any right or remedy to which you may otherwise be entitled under the consumer guarantee provisions of the Australian Consumer Law.
 - c. in the event that a request for repair is made against this Kleenmaid Warranty where the serial number for the Product cannot be verified or you cannot produce for verification a proof of purchase for the Product (including but not limited to the original invoice), the repairer will not carry out any repairs on the Product and you will be charged a service call-out fee.
6. What is covered by this Kleenmaid Warranty: -
 - a. the Product is covered for faulty workmanship or parts that have failed under normal Domestic Use.
 - b. Kleenmaid and/or its agents will determine by objective testing if there are any defects in the Product and/or faulty workmanship.
 - c. this Kleenmaid Warranty is only applicable if repairs on Products are carried out within Mainland Australia.
 - d. this Kleenmaid Warranty: -
 - i. covers a Product purchased as new, manufactured for use in Mainland Australia;
 - ii. commences from the date of delivery of the Product;
 - iii. provides for the labour and replacement parts necessary to maintain the Product in good operating condition as specified in this Kleenmaid Warranty, however, if repair is needed because of Product failure during normal Domestic Use, Kleenmaid has the option to repair or replace the defective Product or part of the Product with a product or part of like kind and quality. A replacement part may be new or reconditioned of like kind and quality and may cost less than the original Product purchased and no charges or refunds will be made based on the replacement product or part cost difference; and
 - iv. is only applicable when the Product is used and operated in accordance with the Manufacturer's instructions.
7. What is not Covered by this Kleenmaid Warranty (excluded):-
 - a. any damage or failure to or of the Product or part of the Product:
 - i. due to the Product being inadequately serviced to manufacturer's recommendations;
 - ii. resulting from environmental conditions including and not limited to dirt, dust, rodents, insects, rust, corrosion, salt built-up, or of in any part of the Product;
 - iii. resulting from excessive use but fair wear and tear is excepted;
 - iv. resulting from installation by an unqualified or uncertified tradesperson;
 - v. resulting from poor or incorrect installation including and not limited to positioning and externally fitted equipment such as plumbing and drainage, cabling, antennae or due to incompatibility of connected equipment;
 - vi. caused by overheating as a result of sitting or positioning of the Product, where there is no provision for adequate ventilation or adequate protection from excessive dust;
 - vii. if the Product has been dismantled, repaired or serviced by any person other than someone authorised by Kleenmaid or its agents or representatives;
 - viii. caused by power surges or spikes, including and not limited to, mains power and telecommunications connections, or to other unspecified sources, incorrect power current, voltage fluctuation, amperage fluctuation, rust or corrosion;
 - ix. if the Product is dropped, collision of the Product with another object, use for which the Product is not designed, damage to the Product caused by your own negligence, accidental or deliberate misuse of the Product by you, theft, abuse, vandalism, flood, fire, earthquake, electrical storms or any other act of God or any war related events; or
 - x. due to the introduction of abnormal heat loads to the Product;
 - b. costs of attendance and testing where no fault or defect covered by the terms of this Kleenmaid Warranty is identified in the Product;
 - c. initial setup and installation of the Product;
 - d. normal maintenance costs and costs incurred through the installation of items listed as requiring periodic replacement;
 - e. Products with removed or altered serial numbers;
 - f. broken or cracked glass other than transport damage to the initial point of delivery;
 - g. consumables such as but not limited to bulbs/globes, seals, filters, batteries and remote controls;
 - h. removal and reinstallation of an internal component not performed by an authorised Kleenmaid agent or representative or authorised service centre;
 - i. cosmetic or structural items; or
 - j. any failures due to interference from or with other products and/or sources.
8. This Kleenmaid Warranty ceases if: -
 - a. the Product ceases to carry the original manufacturer's serial number or is sold at an auction;
 - b. the Product is rented; or
 - c. there is failure to pay monies owing on invoices as a result of non-warranty work being carried out at the request of the end user as per point 16 below.

9. Service under this warranty may be limited by the area in which you live. Service to remote and regional areas may incur additional travel costs which will be payable by you. You will be advised of this at the time you make a claim and Kleenmaid arranges to attend your premises.
10. Neither Kleenmaid nor its representatives provide loan equipment under the terms of this Kleenmaid Warranty.
11. Any unauthorised access to the internal hardware of the Product will void this Kleenmaid Warranty.
12. Repair Notice: Products presented for repair may be replaced by refurbished Products of the same type rather than being repaired. Refurbished parts may be used to repair the Products.
13. Replacement items are "like for like" and is not "new for old" and does not indicate in any way that a faulty Product will be replaced with a new part or unit. "Like for like" may either be a quality checked, refurbished or reconditioned unit of the same or later batch of model/size/specifications
14. The cost of making a claim under this Kleenmaid Warranty is not covered by Kleenmaid, including any costs of transportation or travel expenses between your home and your nearest authorised service agent.
15. Kleenmaid accepts no liability for items that are lost, damaged, or stolen as a result of freight, transport or storage. If you are required to transport the Product to an authorised service centre, you must ensure that it is securely packed and insured.
16. On Public Holidays or other periods when regular business and wholesale operations are temporarily ceased, repairer availability and warranty response times may extend beyond the standard response times due to the unavailability of repairers and parts.
17. For any repair performed on a Product under this Kleenmaid Warranty where no fault can be found, or the item is deemed by Kleenmaid or an authorised agent, to be not faulty under this Kleenmaid Warranty, or the repair or fault is not covered under this Kleenmaid Warranty, a 'No Fault Found' fee is payable by you. Kleenmaid will advise you of this cost and seek your agreement to pay such costs before commencing such repairs.
18. Any repairs or services required that are outside the terms and conditions of this Kleenmaid Warranty can be carried out at your request at your cost (including where the Product has not been installed or set up correctly). Kleenmaid will always advise you of this cost and seek your agreement to pay such costs before commencing such repairs. A credit card may be required prior to the commencement of such services.
19. Extra charges will be payable by the customer should the Product not be readily accessible without special equipment, such as but not limited to cranes and lifts or should the Product be installed in a position that service access is blocked and/or repair work is not possible without uninstalling the Product to gain access.
20. You, the customer, may be entitled to purchase an extended warranty in respect of the Product. Any extended warranty will not be issued by Kleenmaid but by a third party. Any extended warranty services will be provided directly by the third party as principal and not as agent for Kleenmaid, under their extended warranty terms and conditions and not under this Kleenmaid Warranty.
21. To make a claim under this Kleenmaid Warranty, please have your proof of purchase and the serial number of the Product ready and call (02) 9310 1207 during business hours.
22. This Kleenmaid Warranty is given by:
 Name: Compass Capital Services Pty Ltd ABN 96 138 214 525 trading as Kleenmaid
 Business address: Level 2, Suite 3, 204 Botany Rd, Alexandria NSW Australia 2015
 Telephone: (02) 9310 1207
23. Definitions:
 - a. **Australian Consumer Law** means the *Competition and Consumer Act 2010* (Cth).
 - b. **Domestic Use** means use of the Product for personal, domestic or household purposes.
 - c. **Kleenmaid** means Compass Capital Services Pty Ltd ABN 96 138 214 525 trading as Kleenmaid.
 - d. **Mainland Australia** means the following States and Territories of Australia: New South Wales, Victoria, South Australia, Western Australia, Queensland, Tasmania, Northern Territory, Australian Capital Territory.
 - e. **Product** means the appliance sold by Kleenmaid to you as evidenced by the original purchase invoice.
 - f. **Service Agent** means any independent service agent engaged by Kleenmaid to carry out any repair or service under this warranty.
 - g. **Warranty Period** means for domestic use and for Products purchased on or after 1 January 2019 the period of 60 months, otherwise 36 months. For non-domestic use 12 months or such alternative period as may be specified.

UPDATE NOTICE: This Kleenmaid Warranty is current as at 1 December 2022 but is subject to variation from time to time. For the latest version of the Kleenmaid Warranty, please see our website <https://kleenmaid.com.au/warranty/> or phone us on (02) 9310 1207.

Other products available in the Kleenmaid range of appliances

- | Washing machines
- | Clothes dryers
- | Dishwashers
- | Ovens
- | Cooktops
- | Steam ovens
- | Microwave ovens
- | Built in espresso coffee machines
- | Rangehoods
- | Freestanding ovens
- | Refrigerators & Freezers
- | Beverage Serving Cabinets
- | Water Dispensers
- | Vacuum Cleaners

To register your warranty or make a warranty claim, scan this QR code:



Compass Capital Services Pty Limited
trading as Kleenmaid
ABN 96138214525

Level 2, 204 Botany Road Alexandria
NSW 2015



Register your Kleenmaid
Appliances Warranty
www.kleenmaidwarranty.com.au



Request a Warranty Service
www.kleenmaidwarranty.com.au

E: warranty@kleenmaid.com.au

Please download the current User Manual for this
appliance at www.kleenmaid.com.au

 **kleenmaid**