

>> **EV-9UCQ** rangehood/**UNDER MOUNT**/90cm

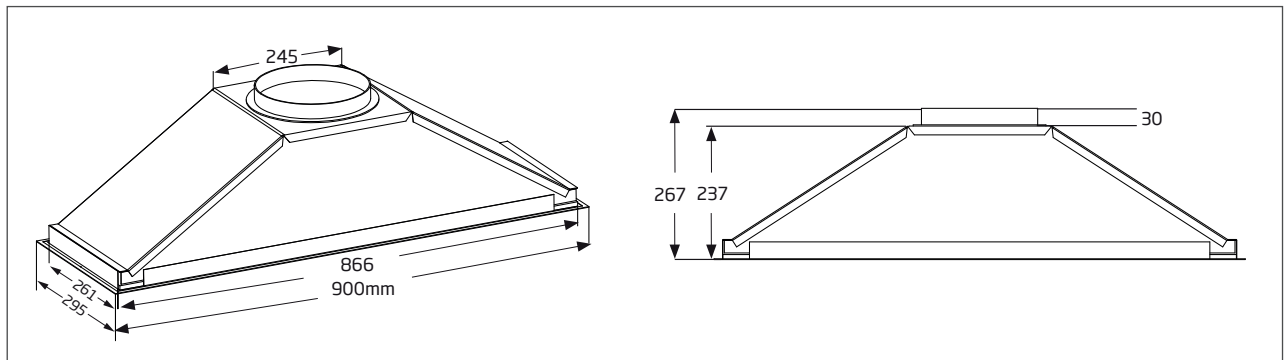

- **easy to use** - stainless steel undermount rangehood integrates seamlessly with kitchen cabinetry, creates a functional, practical kitchen.
- **powerful silent extraction** - externally mounted motor for effective extraction of steam, smoke, and odours, leaves kitchen air fresher.
- **strong lighting** - Incandescent lighting over the cooking zone.
- **mesh filters** - aluminium, dishwasher safe.



Description	Technical data	Motor power
<ul style="list-style-type: none"> • stainless steel finish • silent motor system • manual controls • single speed level • LED lighting • aluminium, dishwasher safe filters • 2 Year Warranty on rangehood • 10 Year Warranty on Isodrive motor 	<p>EV-9UCQ</p> <ul style="list-style-type: none"> • dimensions: (W x D) 900 x 295 mm • 3 x aluminium mesh filters • 2 x 3W LED bayonet light bulbs 	<ul style="list-style-type: none"> • ST 900 - single external motor - 900 m³/h airflow - 200mm SteelFlex™ ducting (4m) - install roof/wall

address: Unit 4/1-5 Lake Drive, Dingley Village VIC 3172
 phone: 1300 881 693
 email: sales@schweigen.com.au
 web: www.schweigen.com.au