



euro
appliances

rangehoods

USAGE AND
CARE GUIDE

PRODUCT
CODE:
ERB120SS3R



Content

SAFETY INSTRUCTIONS.....	3
INSTALLATION (VENT OUTSIDE).....	5
Start Using Your Cooker Hood	10
TROUBLESHOOTING.....	13
MAINTENANCE AND CLEANING	14
ENVIRONMENTAL PROTECTION:.....	18

SAFETY INSTRUCTIONS

This manual explains the proper installation and use of your cooker hood, please read it carefully before using even if you are familiar with the product. The manual should be kept in a safe place for future reference.

Never to do:

- Do not try to use the cooker hood without the grease filters or if the filters are excessively greasy!
- Do not install above a cooker with a high level grill.
- Do not leave frying pans unattended during use because overheated fats or oils might catch fire.
- Never leave naked flames under the cooker hood.



- If the cooker hood is damaged, do not attempt to use.
- Do not flambé under the cooker hood.
- CAUTION: Accessible parts may become hot when used with cooking appliances.
- The minimum distance between the supporting surface for the cooking vessels on the hob and the lowest part of the cooker hood. (When the cooker hood is located above a gas appliance, this distance shall be at least 65 cm)
- The air must not be discharged into a flue that is used for exhausting fumes from appliances burning gas or other fuels.



- It is necessary to allow disconnection of the appliance from the supply after installation. The disconnection can be achieved by having the plug accessible or by incorporating a switch in the fixed wiring in accordance with the wiring rules.

Always to do:

- Important! Always switch off the electricity supply at the mains during installation and maintenance such as light bulb replacement.
- The cooker hood must be installed in accordance with the installation instructions and all measurements followed.
- All installation work must be carried out by a competent person or qualified electrician.
- Please dispose of the packing material carefully. Children are vulnerable to it.
- Pay attention to the sharp edges inside the cooker hood especially during installation and cleaning.
- Make sure the ducting has no bends sharper than 90 degrees as this will reduce the efficiency of the cooker hood.
- Warning: Failure to install the screws or fixing device in accordance with these instructions may result in electrical hazards
- Warning: Before obtaining access to terminals, all supply circuits must be disconnected.

Always to do:

- Always put lids on pots and pans when cooking on a gas cooker.
- When in extraction mode, air in the room is being removed by the cooker hood. Please make sure that proper ventilation measures are being observed. The cooker hood removes odours from room but not steam.
- Cooker hood is for domestic use only.



- If the supply cord is damaged, it must be replaced by the manufacturer, its service agent or similarly qualified persons in order to avoid a hazard.
- This appliance is not intended for use by persons (including children) with reduced physical, sensory or mental capabilities, or lack of experience and knowledge, unless they have been given supervision or instruction concerning use of the appliance by a person responsible for their safety. Children should be supervised to ensure that they do not play with the appliance. Cleaning and user maintenance shall not be made by children.



- Warning: Before obtaining access to terminals, all supply circuits must be disconnected.

Always to do:

- Caution: The appliance and its accessible parts can become hot during operation. Be careful to avoid touching the heating elements. Children should stay away unless they are under permanent supervision.
- There shall be adequate ventilation of the room when the cooker hood is used at the same time as appliances burning gas or other fuels.
- There is a fire risk if cleaning is not carried out in accordance with the instructions
- Regulations concerning the discharge of air have to be fulfilled.
- Clean your appliance periodically by following the method given in the chapter MAINTENANCE.
- For safety reason, please use only the same size of fixing or mounting screw which are recommended in this instruction manual.
- Regarding the details about the method and frequency of cleaning, please refer to maintenance and cleaning section in the instruction manual.
- Cleaning and user maintenance shall not be made by children without supervision.
- When the cooker hood and appliances supplied with energy other than electricity are simultaneously in operation, the negative pressure in the room must not exceed 4 Pa (4×10^{-5} bar).
- WARNING: Danger of fire: do not store items on the cooking surfaces.
- A steam cleaner is not to be used.
- NEVER try to extinguish a fire with water, but switch off the appliance and then cover flame e.g. with a lid or a fire blanke.

INSTALLATION (VENT OUTSIDE)

MOUNTING OF THE V-FLAP

If the cooker hood does not have an assembled V-flap 1, you should mount the half-parts to its body. The images only show an example of how to mount the V-flap, the outlet may be various according to different models and configuration.

To mount the V-flap 1 you should:

- Mount two half-parts 2 into the body 6
- a pin 3 should be top oriented;
- the axis 4 should be inserted in the holes 5 on body;
- repeat all the operations for the 2nd half-part

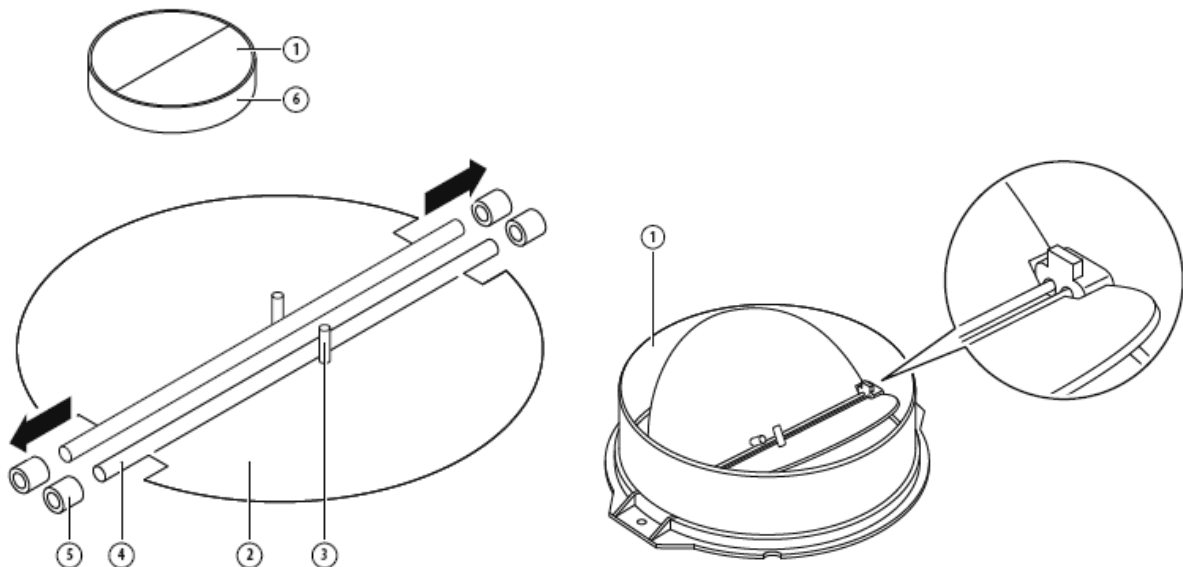

INSTALLATION

If you have an outlet to the outside, your cooker hood can be connected as below picture by means of an extraction duct (enamel, aluminum, flexible pipe or non-flammable material with an interior diameter of 150mm)

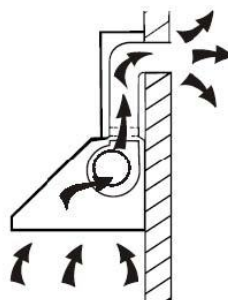

1. Before installation, turn the unit off and unplug it from the outlet.



2. The cooker hood should be placed at a distance of 65~75cm above the cooking surface for best effect. See pic 1.

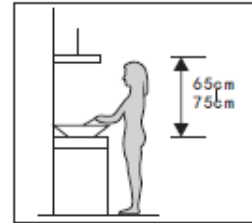

Pic 1

3. Once the installation height of hook, inside chimney bracket and safety hole is fixed according to pic 2, drill 6 ϕ 11mm holes on the wall.

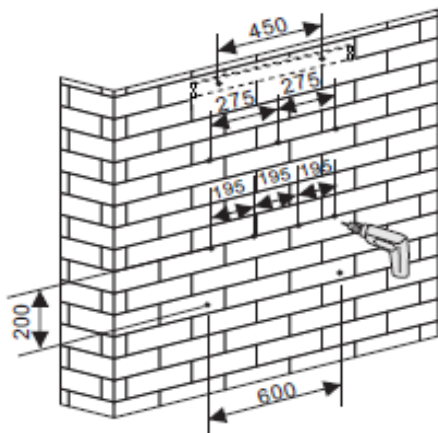

Pic 2

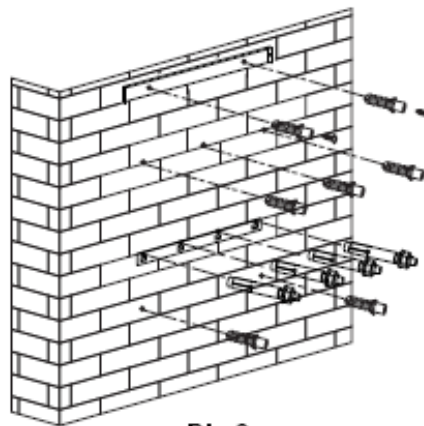

Pic 3

4. Insert 7 pcs wall plugs into the holes of inside and outside chimney brackets as well as the safety hole. Put 4 pcs M6*60 screws into the corresponding 4 holes for the hook and fix it on the wall. Then use 2 pcs ST4*40mm screws to install the inside chimney bracket on the wall. See pic 3.

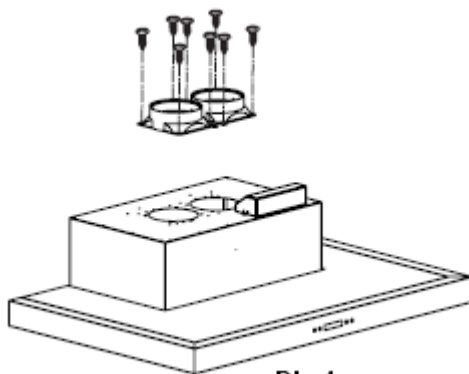

Pic 4

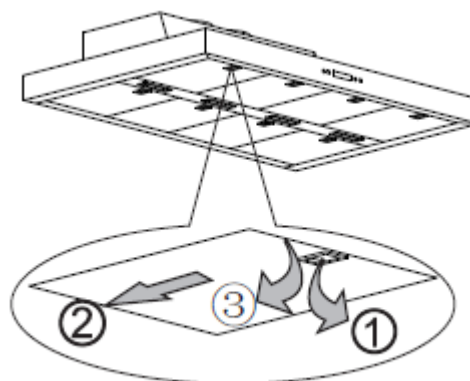

Pic 5

5. Fix the outlet on the hood by 8 pcs screws as shown in pic 4. (If the air outlet is already installed, please skip this step)
6. Open and take down the 8 filters in order following the 3 steps in pic 5.

7. Hang the cooker hood on the hook. See pic 6.

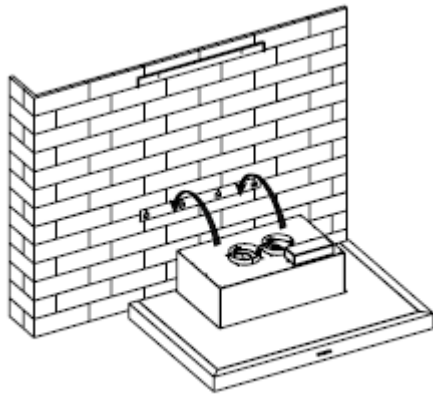

Pic 6

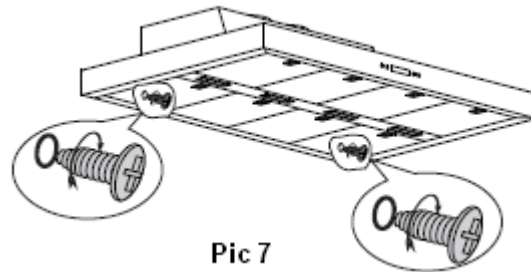

Pic 7

8. Fasten ST4*30mm screws to the two safety holes on the cavity and fix the cooker hood. Note: The two safety vents are positioned on the back housing, with diameter of 6mm. See pic 7.
9. Lay the expansion pipe to the two blower outlet, and fix the expansion pipe with cable tie. See Pic 8

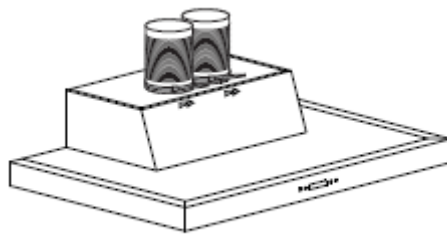

Pic 8

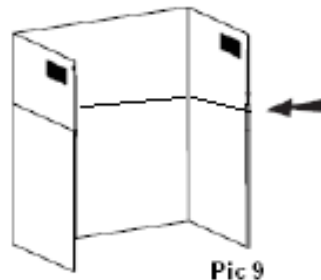

Pic 9

10. Put the inside chimney into the outside chimney. See pic 9.
11. Fix the outside chimney bracket on the wall with 3 pcs ST4*40 screws. See pic 10.

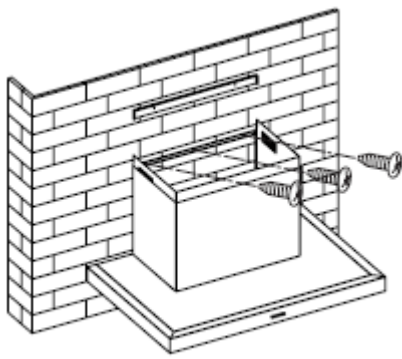

Pic 10

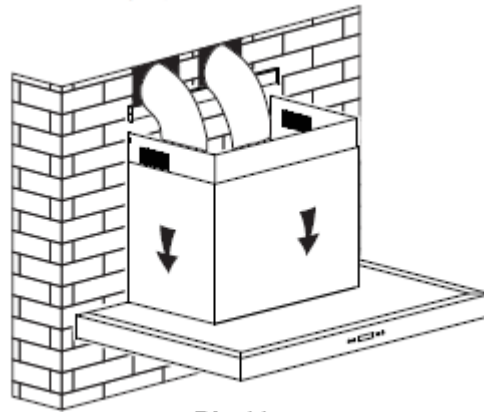

Pic 11

12. See pic 11, Put the chimney on the cooker hood and be sure that the inside chimney can be adjusted the height in it freely. Then lead the expansion pipe to outside.

13. Adjust the height of the inside chimney to the position of the inside chimney bracket and fix on it by 2 pcs ST4*8mm screws. See pic 12.

14. Install the inside chimney cover to the top of inside chimney with 2pcs ST4*8mm screws. See pic 13.

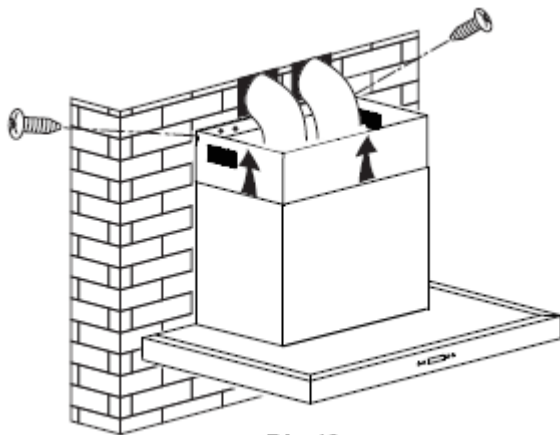

Pic 12

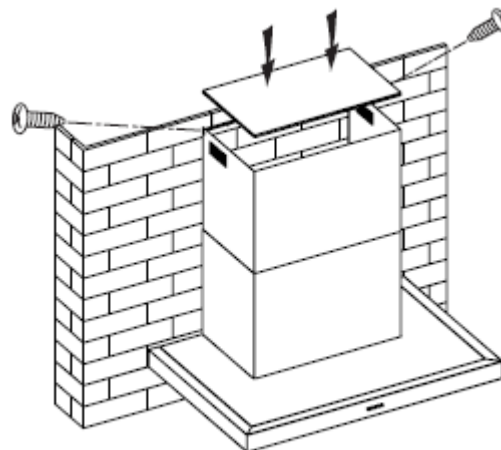

Pic 13

HINTS FOR EXHAUST DUCT INSTALLATION

The following rules must be strictly followed to obtain optimal air extraction:

- Keep expansion pipe short and straight.
- Do not reduce the size or restrict expansion pipe.
- When using expansion pipe always install the pipe pulled taut to minimize pressure loss.

- Failure to observe these basic instructions will reduce the performance and increase noise levels of the cooker hood.
- Any installation work must be carried out by a qualified electrician or competent person.
- Do not connect the ducting system of the hood to any existing ventilation system which is being used for any other appliance, such as warmer tube, gas tube, hot wind tube.
- The angle of the bend of the expansion pipe should not be less than 120°; you must direct the pipe horizontally, or, alternatively, the pipe should go up from the initial point and should be led to an outer wall.
- After the installation, make sure that the cooker hood is level to avoid grease collection at one end.
- Ensure the expansion pipe selected for installation complies with relevant standards and is fire retardant.

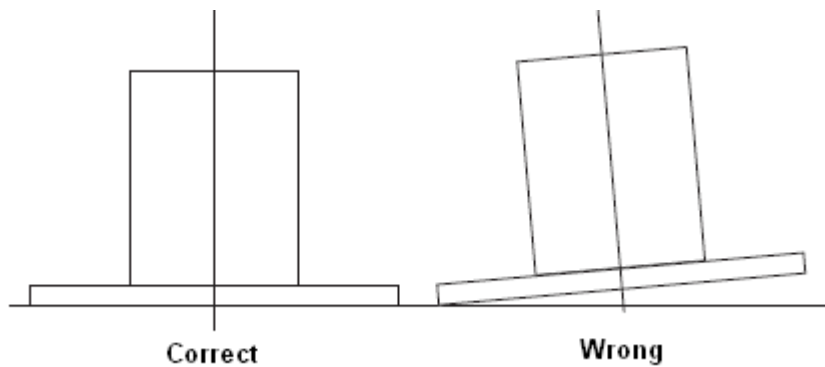



<p>WARNING:</p> 	<p>For safety reason, please use only the same size of fixing or mounting screw which are recommended in this instruction manual.</p> <p>Failure to install the screws or fixing device in accordance with these instructions may result in electrical hazards.</p>
--	---



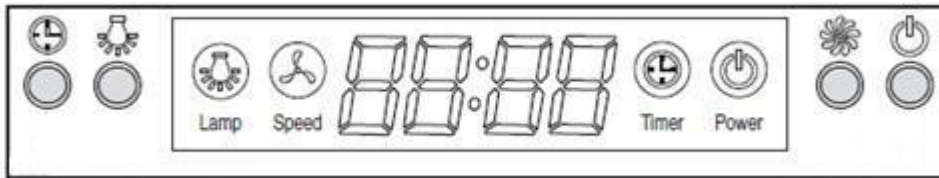





Start Using Your Cooker Hood



Control



















Plug the hood; LCD will display 24-hour system with blue backlight. Backlight will be extinguished after 15 seconds without any operation.













Press  button once; lights will be on and LCD will show **"Lamp"**. Press  button again; lights will be off and **"Lamp"** on LCD will disappear.

Press  button once; the hood works at LOW speed and LCD will show **"Speed"** and  button will be on. Press  button again; the hood works at MEDIUM speed. Press  button one more time; the hood works at HIGH speed. Press  button again; the hood works at LOW speed again and it repeat. While pressing  button; the  button is always on. If you want to stop the hood now; press the  button once.

When the hood is not working; press  button once. The hood will work at the speed it works last time and LCD will show **"Speed"**. Press  button again; the hood stop working and **"Speed"** will disappear from LCD.



When both  button and  button don't work;  button is used for time-setting. Press  button for 2 to 3 seconds; **12:00** will be shown on LCD and **12** flashes; which represents hour. Press  button once the number adds by 01. Continue pressing  button; it will display from 13;14... until 23. When LCD shows 23; it doesn't work by pressing  button. Press  button once; the number reduces by 01. When LCD shows 00; it doesn't work by pressing  button. After setting hour; you can start setting minute by pressing  button again. **00** on LCD flashes; which represents minutes. Press  button once the number adds by 01. Continue



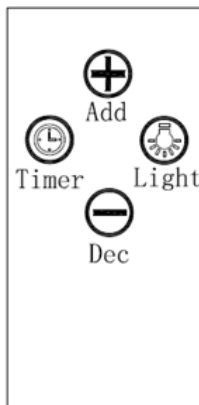

pressing “” button; it will display from 01;02... until 59. When LCD shows 59; it doesn't work by pressing “” button. Press “” button once; the number reduces by 01. When LCD shows 00; it doesn't work by pressing “” button. After setting hour and minute; press “” to confirm.

When “” button doesn't work; “” button is used for delay timer function. Delay timer function allows you to set the hoods automatically power off according to the delay timer you set from 1 minute to 60 minutes. Press “” button once; it enters for delay timer setting and LCD shows . Press “” button once the number adds by 01. Continue pressing “” button; it will display from ; ;  ... until . Press “” button once; the number reduces by 01. After setting delay timer you want; press “” button to confirm. If you set delay timer as 05:00; the LCD display will show from 05:00; 04:59... until 00:01 00:00. When LCD shows 00:00; the hood will automatically power off and LCD display will only show 24-hour system with blue backlight. After 30 seconds without operation; blue backlight will disappear. But please note the Lamp is not under control of delay timer. Next time; if you want to use delay timer function and you press “” button without any change on time. The hood will automatically count time down from your previous setting after 5 seconds.

Remote control



1. press button once , the light is on, press again, the light is off. The lighting button it is controlled separately and will not affect any other functions.
2. Turning on/ Increasing motor speed key , the motor has low, mid, high totally 3 levels.
 - a) Press  one time, the motor will work at low speed (Turning on).

- b) When the hood works at low speed, touch  again, the motor changes to mid speed.
- c) Base on the middle speed condition, touch  again, the motor is running in the high speed.
- d) Base on the high speed condition, touch  again, the hood still works at high speed.
3. Turning off/Decreasing motor speed key  . Press the button and the motor begins shift to a lower speed and the LCD screen display the speed level. Repeating press the button, it keep on decreasing the motor speed till the cooker hood turning off.
4. Low speed, mid speed and high speed cannot work at the same time. When hood is on high speed, press the speed decrease, it will turn to a lower speed; when it is in low speed, press the speed increase, it will turn to a higher speed.
5. Timer  Press the button to set up the timer on/off function.



WARNING!

The coin cell battery in the remote control is hazardous and must be kept away from children (whether the battery is new or used).

If the battery is swallowed, or placed inside any part of the body, it can cause severe or fatal injuries in 2 hours or less.

Immediately seek medical attention or contact the Poisons Information Centre on 13 11 26 if it is suspected the battery has been swallowed or placed inside any part of the body.

Dispose used batteries immediately.

TROUBLESHOOTING

Fault	Possible Cause	Solution
Light on, but motor does not work	Fan switch turned off	Select a fan switch position.
	Fan switch failed	Contact service center.
	Motor failed	Contact service center.
Light does not work, motor does not work	House fuses blown	Reset/Replace fuses.
	Power cord loose or disconnected	Refit cord to power outlet. Switch power outlet on.
Oil leakage	One way valve and the outlet are not tightly sealed	Take down the one way valve and seal with sealant.
	Leakage from the connection of chimney and cover	Take chimney down and seal.
Lights not working	Broken/Faulty globes	Replace globes as per this instruction.
Insufficient suction	The distance between the cooker hood and the gas top is too far	Refit the cooker hood to the correct distance.
The Cooker hood inclines	The fixing screw not tight enough	Tighten the hanging screw and make it horizontal.

NOTE:



Any electrical repairs to this appliance must conform to your local, state and federal laws. Please contact the service centre if in any doubt before undertaking any of the above. Always disconnect the unit from the power source when opening the unit.

MAINTENANCE AND CLEANING

Caution:

- Before maintenance or cleaning is carried out, the cooker hood should be disconnected from the main power supply. Ensure that the cooker hood is switched off at the wall socket and the plug removed.

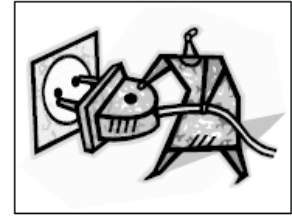

- External surfaces are susceptible to scratches and abrasions, so please follow the cleaning instructions to ensure the best possible result is achieved without damage.

GENERAL

Cleaning and maintenance should be carried out with the appliance cold especially when cleaning. Avoid leaving alkaline or acid substances (lemon juice, vinegar etc.) on the surfaces.

STAINLESS STEEL

The stainless steel must be cleaned regularly (e.g. weekly) to ensure long life expectancy. Dry with a clean soft cloth. A specialized stainless steel cleaning fluid may be used.

NOTE:

Ensure that wiping is done along with the grain of the stainless steel to prevent any unsightly crisscross scratching patterns from appearing.

CONTROL PANEL SURFACE

The inlay control panel can be cleaned using warm soapy water. Ensure the cloth is clean and well wrung before cleaning. Use a dry soft cloth to remove any excess moisture left after cleaning.

Important

Using neutral detergents and avoid using harsh cleaning chemicals, strong household detergents or products containing abrasives, as this will affect the appliance appearance and potentially remove any printing of artwork on the control panel and will void manufacturer's warranty.

GREASE MESH FILTERS

The mesh filters can be cleaned by hand. Soak them for about 3 minutes in water with a grease-loosening detergent then brush it gently with a soft brush. Please do not apply too much pressure, avoid to damage it. (Leave to dry naturally out of direct sun light)

Filters should be washed separately to crockery and kitchen utensils. It is advisable not to use rinse aid.

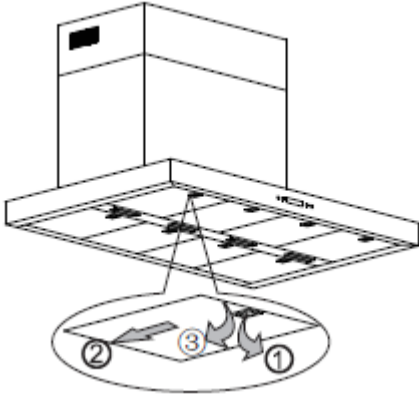

INSTALLING GREASE MESH FILTERS

- To install filters for the following four steps.
- Angle the filter into slots at the back of the hood.
- Push the button on handle of the filter.
- Release the handle once the filter fits into a resting position.
- Repeat to install all filters.

BULB REPLACEMENT

<p>Important :</p> 	<p>Always switch off the electricity supply before carrying out any operations on the appliance. When handling bulb, make sure it is completely cooled down before any direct contact to hands.</p> <p>When handling globes hold with a cloth or gloves to ensure perspiration does not come in contact with the globe as this can reduce the life of the globe.</p>
--	--

Note:

Before changing the lights, make sure that the appliance is plugged off.

Protect against danger when changing lights, such as wearing gloves.

Changing the lights:

Remove the grease filter.

Way 1. Use a tool or the hand to press the spring splinter of both sides of LED light to the inside, until the light is pressed out, see pic 1. Then slightly pull the light connecting wire out, and dismantle the terminal of the light connecting wire. See pic 2.

Way 2. Use straight screwdriver to prize up the LED light bottom edge, see pic 3, then slightly pull out the LED light and light connecting wire. See pic 2.

Apply the reverse procedure to install the light back.

- ILCOS D code for this lamp is: DSS-1.5/65-S-120/33
- Max wattage: $4 \times 1.5W$
- Voltage range: DC 12V
- Dimensions:

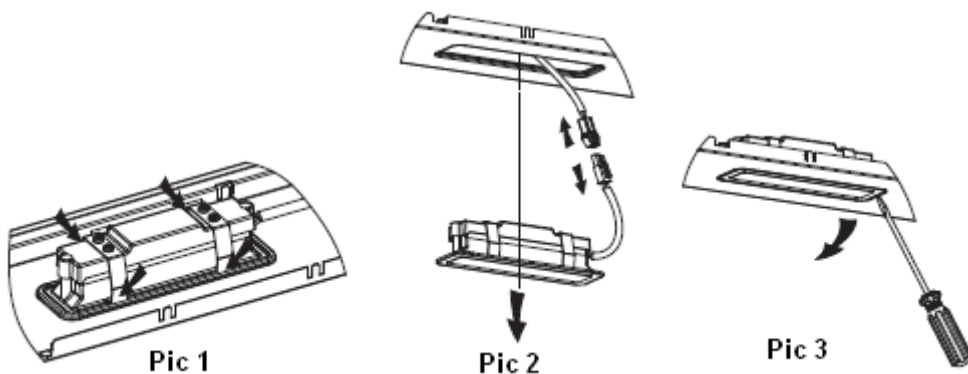
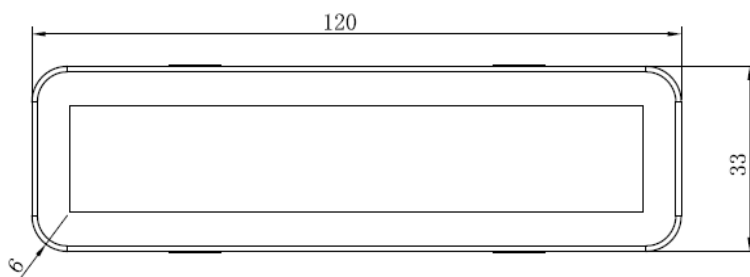

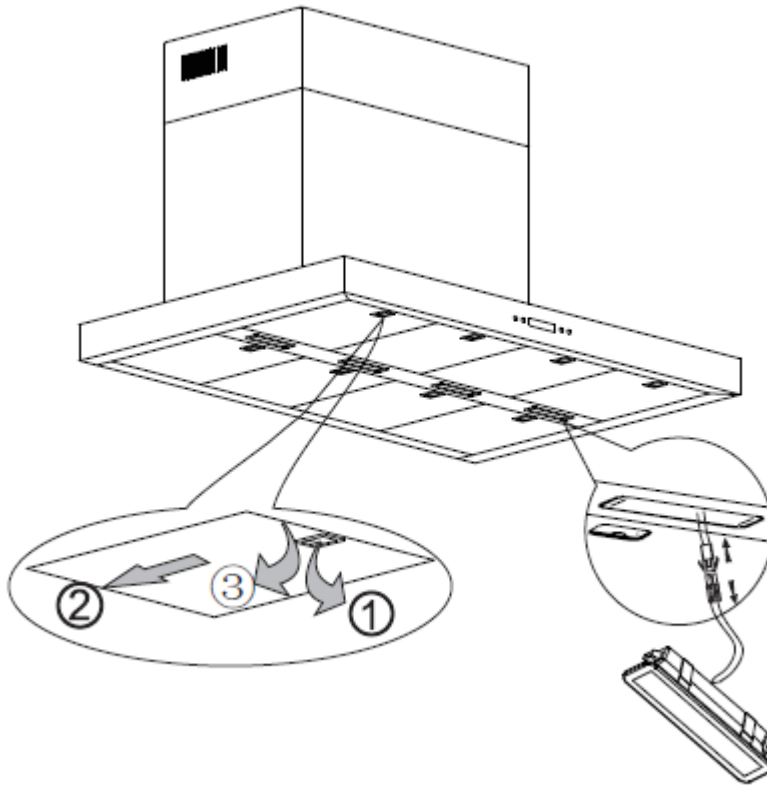

ENVIRONMENTAL PROTECTION:

	<p>This product is marked with the symbol on the selective sorting of waste electronic equipment. This means that this product must not be disposed of with household waste but must be supported by a system of selective collection in accordance with Directive 2012/19/EU. It will then be recycled or dismantled to minimize impacts on the environment, electrical and electronic products are potentially dangerous for the environment and human health due to the presence of hazardous substances. For more information, please contact your local or regional authorities.</p>
---	---

NOTE:

The following shows how to reduce total environmental impact (e.g. energy use) of the cooking process).

Install the cooker hood in a proper place where there is efficient ventilation.

Clean the cooker hood regularly so as not to block the airway.

Remember to switch off the cooker hood light after cooking.

Remember to switch off the cooker hood after cooking.

INFORMATION FOR DISMANTLING

Do not dismantle the appliance in a way which is not shown in the user manual. The appliance could not be dismantled by user. At the end of life, the appliance should not be disposed of with household waste. Check with you Local Authority or retainer for recycling advice.



Pronto Service + Support: 1800 440 335
Email: service@eurostylegroup.com.au

HEAD OFFICE

65 Glynburn Road, Glynde SA 5070
Ph: 08 8165 1012

www.euroappliances.com.au