



cooking

USAGE AND  
CARE GUIDE

PRODUCT  
CODE:  
EP6004SX



## ACKNOWLEDGEMENT

Thank you for purchasing our product. We hope you enjoy using the many features and benefits it provides. Before using this product please study this entire Instruction Manual carefully. Keep this manual in a safe place for future reference. Ensure that other people using the product are familiar with these instructions as well.

## WARNING

When the oven is first switched on, it may give off an unpleasant smell. This is due to the bonding agent used for the insulating panels within the oven. This is completely normal, if it does occur, you merely have to wait for the smell to clear before putting food into the oven.

- Do not use harsh abrasive cleaners or sharp metal scrapers to clean the glass of the oven. This can scratch the surface and may result in permanent damage to the glass.
- During use, the appliance becomes very hot. Care should be taken to avoid touching heating elements inside the oven.
- Do not allow children to go near the oven when it is operating, especially when the grill is on.
- Ensure that the appliance is switched off before replacing the oven lamp to avoid the possibility of electric shock.
- The means for disconnection must be incorporated in the fixed wiring in accordance with the wiring specifications.
- Conductors of supply cords shall have a nominal cross-sectional area not less than 3G1.5mm<sup>2</sup>.
- This appliance is not intended for use by persons (including children) with reduced physical, sensory or mental capabilities, or lack of experience and knowledge, unless they have been given supervision or instruction concerning use of the appliance by a person responsible for their safety.

## SAFETY HINTS

- The oven must be used only for the purpose for which it was designed; it must only be used for cooking food. Any other use, e.g. as a form of heating is a breach of use and is therefore dangerous. The manufacturer will not be held liable or responsible for any damage to a property caused through incorrect use. When using any electrical appliance you must follow a few basic rules.
- Do not use the oven unless you are wearing something on your feet. Do not touch the oven with wet or damp hands or feet.
- Do not allow children or irresponsible people to use the oven unless they are carefully supervised.
- If the above instructions are not adhered to the manufacturer cannot guarantee the safe operation of the oven.
- Do not use the power cord with an adapter, power board or extension cable.
- If the cable is damaged it must be replaced promptly by a qualified technician.
- If the oven breaks down or develops a fault, switch it off at the mains and do not touch it. Please contact the After Sales Service Centre.
- If the cable is at all damaged it must be replaced promptly. When replacing the cable, follow these instructions.
  - Remove the power cable and replace it with one of the H05VV-F, and H05V2V2-F type.
  - The cable must be able to bear the electrical current required by the oven.
  - Cable replacement must be carried out by properly qualified technicians.

- The earthing cable (yellow-green) must be 10mm longer than the power cable.
- Heating resistance temperature of power cord is above 70°C. The power cord should be connected with duplex switch, which is no less than 250V and 20A (no need to be connected with plug).

## FITTING THE OVEN INTO THE KITCHEN UNIT

Fit the oven into the space provided in the kitchen unit; it may be fitted underneath a work top or into an upright cupboard. Fix the oven in position by screwing into place, using the two fixing holes in the frame. To locate the fixing holes, open the oven door and look inside. To allow adequate ventilation, the measurements and distances adhered to when fixing the oven.

## IMPORTANT

If the oven is to work properly, the kitchen housing must be suitable. The panels of the kitchen unit that are next to the oven must be made of a heat resistant material. Ensure that the glues of units that are made of veneered wood can withstand temperatures of at least 120°C. Plastics or glues that cannot withstand such temperatures will melt and deform the unit, once the oven has been lodged inside the units, electrical parts must be completely insulated. This is a legal safety requirement. All guards must be firmly fixed into place so that it is impossible to remove them without using special tools. Remove the back of the kitchen unit to ensure an adequate current of air circulates around the oven. The hob must have a rear gap of at least 45 mm.

## DECLARATION OF COMPLIANCE

When you have unpacked the oven, make sure that it has not been damaged in any way. If you have any doubts at all, do not use it: contact a professionally qualified person. Keep packing materials such as plastic bags, polystyrene, or nails out of the reach of children because these are dangerous to children.



## HOW TO USE

- Stay on: For the oven to be used in the "◇". the food may catch fire if the cooking time is set too long. Close supervision is necessary during toasting and the time should not be set too long. NOTE: For cooking times which are under sixty minutes, first set to a longer time and then turn the switch back to the time you require.
- To set functions by turning the function knob to desired level.  
The oven will automatically start cooking after function, time and temperature are set.
- To set the time of cooking by turning the timer knob to desired time per your food cooking guide. After the cooking time is up, the unit will "Dong" to stop.
- To set the temperature by turning the temperature knob.  
If the unit is not in use, always set the knobs to "0".

## PRODUCT DESCRIPTION

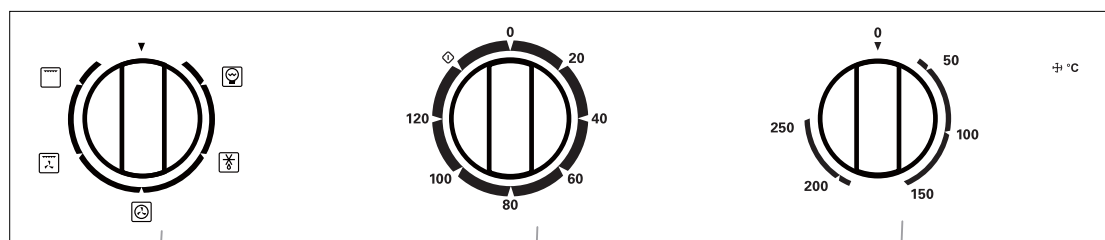

Function Knob

Timer knob

Temperature Knob

Symbol	Function description
	Oven Lamp: which enables the user to observe the progress of cooking without opening the door.
	Defrost: The circulation of air at room temperature enables quicker thawing of frozen food, (without the use of any heat). It's a gentle but quick way to speed up the defrosting time and thawing of ready-made dishes and cream filled produce etc.
	Fan forced: An element around the convection fan provides an additional source of heat for convection style cooking. In convection mode the fan automatically comes on to improve air circulation within the oven and creates an even heat for cooking. The temperature can be set within the range of 50-240°C.
	Radiant grilling: The inner grill element switches on and off to maintain temperature. Best results can be obtained from using the top shelf for small items and lower shelves for large items.
	Double grilling with fan: The inside radiant element and top element are working with fan

Kindly reminder: To open the oven door, always use one hand to hold the handle in the centre and do not touching the child lock stud.

## ACCESSORIES

Wire shelves : For grill dishes, cake pan with items for roasting and grilling.

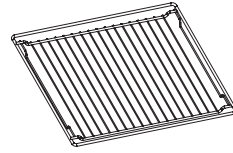

Slider bracket : These shelf support rails on the right and left sides of the oven can be removed for cleaning oven walls.

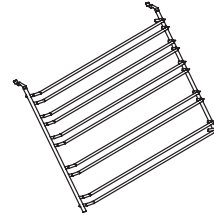

Universal pan: For cooking large quantities of food such as moist cakes, pastries, frozen food etc, or for collecting fat/ spillage and meat juices.

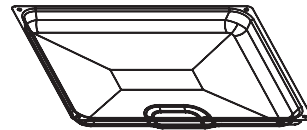

## SHELF PLACEMENT WARNING:

To ensure the oven shelves operate safely, correct placement of the shelves between the side rails is imperative. This will ensure that during careful removal of the shelf or tray, hot food items should not slide out.

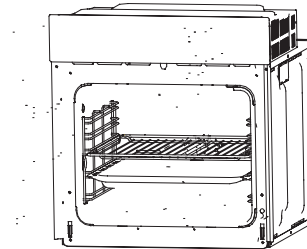

## SECURING THE OVEN TO THE CABINET

1. Fit oven into the cabinet recess.
2. Open the oven door.
3. Secure the oven to the kitchen cabinet with two distance holders "A" which fit the holes in the oven frame and fit the two wood screws "B".

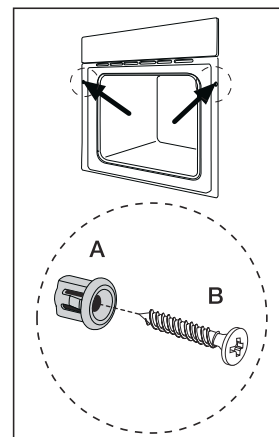

## BULB REPLACEMENT

The bulb in the light is a special bulb, and has high temperature resistance (240V~25W).

For replacement, proceed as follows:

- 1>.Disconnect power from the mains outlet or switch off the circuit breaker of the unit's mains outlet.
- 2>.Unscrew the covering glass and replace the bulb with a new one of the same type.
- 3>.Screw the covering glass back in place.

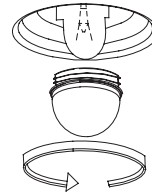

## VENTILATING OPENINGS

When cooking finish, the cavity temperature is over 70 degree. The ventilating opening will continue working for 15 minutes after the oven stop cooking.

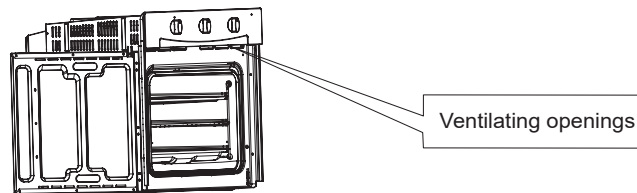

## CONNECTION OF THE OVEN

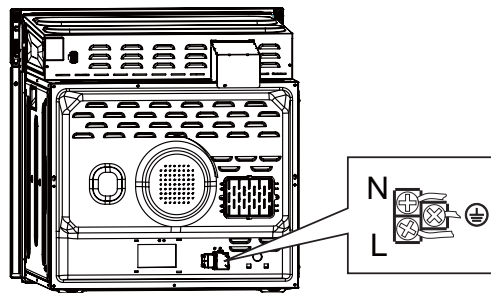

## INSTALLATION

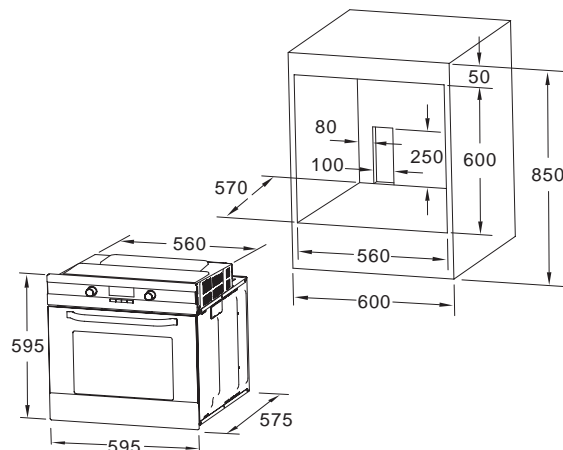

NOTE: The number of accessories included depends on the particular appliance purchased.

## CLEANING AND MAINTENANCE

For the sake of a good appearance and reliability, keep the unit clean. The modern design of the unit facilitates maintenance to a minimum. The parts of the unit which come into contact with food have to be cleaned regularly.







- Before any maintenance and cleaning, disconnect the power.
- Set all controls in the OFF position.
- Wait until the inside of the unit is not hot but only slightly warm- cleaning is easier than when warm.
- Clean the surface of the unit with a damp cloth, soft brush or fine sponge and then wipe dry.  
In case of heavy soiling, use hot water with non- abrasive cleaning product.
- For cleaning the glass of the oven door,do not use abrasive cleaners or sharp metal scrapers, these can scratch the surface or lead to the glass being damaged.
- Never leave acidic substances (lemon juice, vinegar) on stainless steel parts.
- Do not use a high pressure cleaner for cleaning the unit. The baking pans may be washed in mild detergent.

This appliance is marked according to the European directive 2002/96/EC on Waste Electrical and Electronic Equipment(WEEE).

By ensuring this product is disposed correctly, you will help prevent potential negative consequences for the environment and human health,which could otherwise be caused by inappropriate waste handling of this product. The symbol on the product indicates that this product may not be treated as household waste. Instead it shall be handed over to the applicable collection point for the recycling of electrical and electronic equipment. Disposal must be carried out in accordance with local environmental regulations for waste disposal.For more detailed information about treatment, recovery and recycling of this product, please contact your local city office, your household waste disposal service or the shop where you purchased the product.



## Table and tips

Food	Weight	Shelf position	Cooking Method	Temp. °C	Time		Dish
					1st side (min.)	2nd side (min.)	
Beef	1kg	5		200	10-15	8-10	Baking tray
Pork	2kg	3		200	90-100	-----	wire shelves
Chicken	1.2kg	3		200	50-60	-----	wire shelves
Small cakes	0.3-0.4kg	3		180	20-25	-----	wire shelves
Apple pie	1.2kg	3		160	50-60	-----	wire shelves
Small cakes	0.3-0.4kg	3		160	20-50	-----	wire shelves
Sponge cake	0.5kg	3		150	30-35	-----	-----





**Pronto** Service + Support: 1800 440 335  
Email: [service@eurostylegroup.com.au](mailto:service@eurostylegroup.com.au)

HEAD OFFICE

65 Glynburn Road, Glynde SA 5070  
Ph: 08 8165 1012

**[www.euroappliances.com.au](http://www.euroappliances.com.au)**