



euro
appliances

rangehoods

USAGE AND
CARE GUIDE

PRODUCT
CODE:

EBB900BK3R
EBB900SS3R



Content

1.....	Safety instructions
3.....	Installation
6.....	Start using your cooker hood
9.....	Troubleshooting
9.....	Maintenance and cleaning
13.....	Environment protection

SAFETY INSTRUCTIONS

This manual explains the proper installation and use of your cooker hood, please read it carefully before using even if you are familiar with the product. The manual should be kept in a safe place for future reference.

Never to do:

- Do not try to use the cooker hood without the grease filters or if the filters are excessively greasy!
- Do not install above a cooker with a high level grill.
- Do not leave frying pans unattended during use because overheated fats or oils might catch fire.
- Never leave naked flames under the cooker hood.



- If the cooker hood is damaged, do not attempt to use.
- Do not flambé under the cooker hood.
- **CAUTION:** Accessible parts may become hot when used with cooking appliances.
- The minimum distance between the supporting surface for the cooking vessels on the hob and the lowest part of the cooker hood. (When the cooker hood is located above a gas appliance, this distance shall be at least 65 cm)
- The air must not be discharged into a flue that is used for exhausting fumes from appliances burning gas or other fuels. Range hoods and other cooking fume extractors may adversely affect the safe operation of appliances burning gas or other fuels (including those in other rooms) due to back flow of combustion gases. These gases can potentially result in carbon monoxide poisoning. After installation

of a range hood or other cooking fume extractor, the operation of open flued gas appliances should be tested by a competent person to ensure that back flow of combustion gases does not occur.



Always to do:

- **Important!** Always switch off the electricity supply at the mains during installation and maintenance such as light bulb replacement.
- The cooker hood must be installed in accordance with the installation instructions and all measurements followed.
- All installation work must be carried out by a competent person or qualified electrician.
- Please dispose of the packing material carefully. Children are vulnerable to it.
- Pay attention to the sharp edges inside the cooker hood especially during installation and cleaning.
- Make sure the ducting has no bends sharper than 90 degrees as this will reduce the efficiency of the cooker hood.
- **Warning:** Failure to install the screws or fixing device in accordance with these instructions may result in electrical hazards.
- **Warning:** Before obtaining access to terminals, all supply circuits must be disconnected.

Always to do:

- Always put lids on pots and pans when cooking on a gas cooker.
- When in extraction mode, air in the room is being removed by the cooker hood. Please make sure that proper ventilation measures are being observed. The cooker hood removes odours from room but not steam.
- There shall be adequate ventilation of the room when the cooker hood is used at the same time as appliances burning gas or other fuels.
- Cooker hood is for domestic use only.



- If the supply cord is damaged, it must be replaced by the manufacturer, its service agent or similarly qualified persons in order to avoid a hazard.
- This appliance can be used by children aged from 8 years and above and persons with reduced physical, sensory or mental capabilities or lack of experience and knowledge if they have been given supervision or instruction concerning use of the appliance in a safe way and understand the hazards involved. Children shall not play with the appliance. Cleaning and user maintenance shall not be made by children without supervision.



Always to do:

- **Caution:** The appliance and its accessible parts can become hot during operation. Be careful to avoid touching the heating elements. Children younger than 8 years old should stay away unless they are under permanent supervision.
- There is a fire risk if cleaning is not carried out in accordance with the instructions.
- Regulations concerning the discharge of air have to be fulfilled.
- Clean your appliance periodically by following the method given in the chapter MAINTENANCE.
- For safety reason, please use only the same size of fixing or mounting screw which are recommended in this instruction manual.
- Regarding the details about the method and frequency of cleaning, please refer to maintenance and cleaning section in the instruction manual.
- Cleaning and user maintenance shall not be made by children without supervision.
- When the cooker hood and appliances supplied with energy other than electricity are simultaneously in operation, the negative pressure in the room must not exceed 4 Pa (4×10^{-5} bar).
- **WARNING:** Danger of fire: do not store items on the cooking surfaces.
- A steam cleaner is not to be used.
- **NEVER** try to extinguish a fire with water, but switch off the appliance and then cover flame e.g. with a lid or a fire blanket.

INSTALLATION (VENT OUTSIDE)

MOUNTING OF THE V-FLAP

If the cooker hood does not have an assembled V-flap 1, you should mount the half-parts to its body. The images only show an example of how to mount the V-flap, because the outlet may vary according to different models and configurations.

To mount the V-flap 1 you should:

- Mount two half-parts 2 into the body 6;
- the pin 3 should be top oriented;
- the axis 4 should be inserted into the holes 5 on the body;
- repeat all the operations for the 2nd half-part.

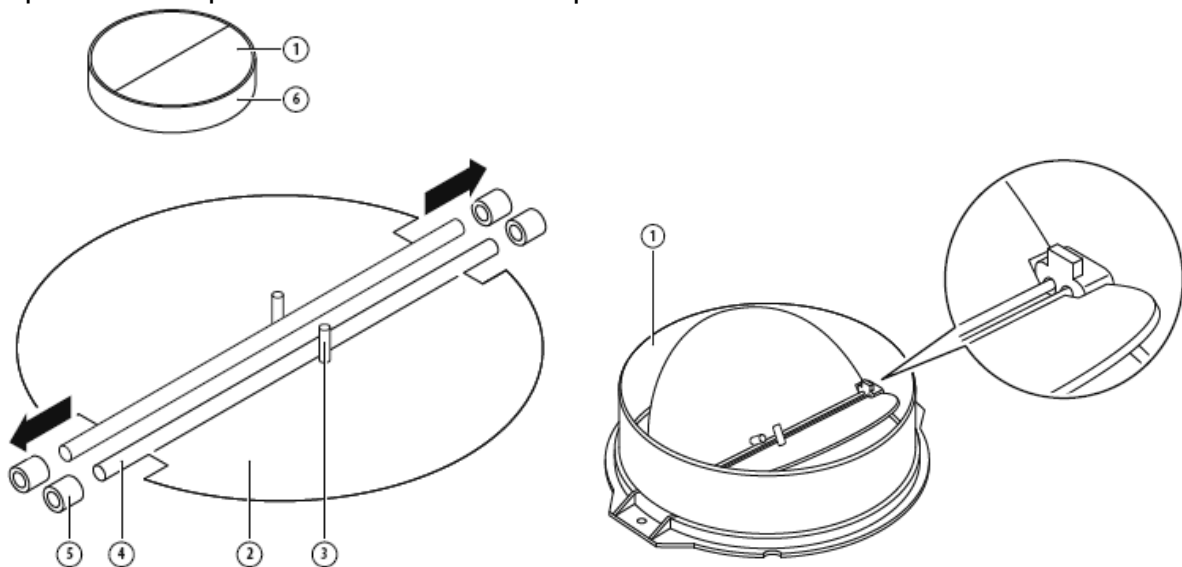

INSTALLATION

If you have an outlet to the outside, your cooker hood can be connected as below picture by means of an extraction duct (enamel, aluminum, flexible pipe or non-flammable material with an interior diameter of 150mm)

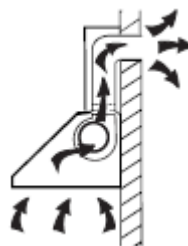

1. Before installation, turn the unit off and unplug it from the outlet.

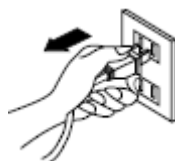

- The cooker hood should be placed at a distance of 65~75cm above the cooking surface for best effect. See pic 1.

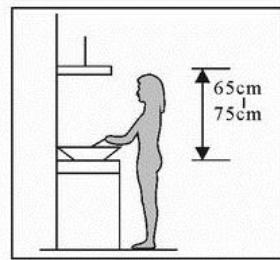

Pic1

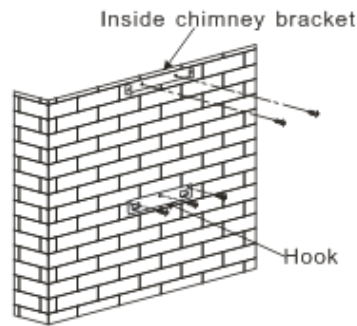

Pic 2

- Install the hook on a suitable place once the installation height is fixed, and keep it in line. The fixed position of the inside chimney bracket is the place of chimney. See pic 2.
- Fix the outside chimney bracket on the outside chimney, and be sure that the inside chimney can be adjusted the height in it freely as well as fixing the expansion pipe. Afterwards, install the expansion pipe and chimney on the cooker hood. Fix the expansion pipe with the cable tie on the outlet. Note :The expansion pipe is not included in the product. See pic 3.

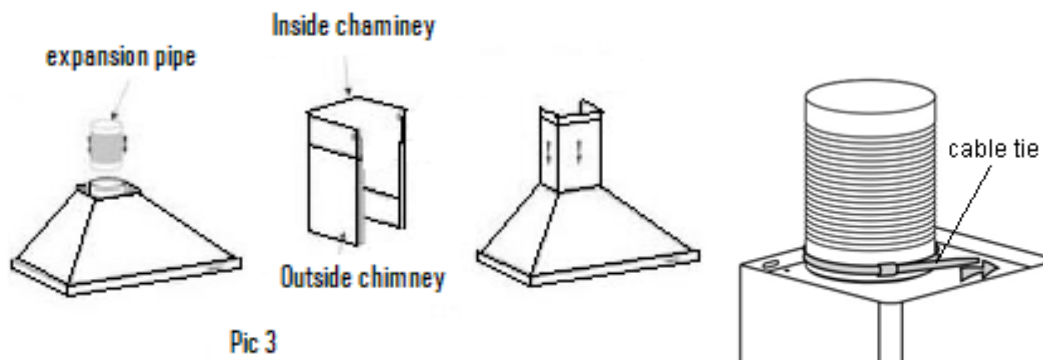

Pic 3

- Put the cooker hood on the hook. See pic 4.

- Adjust the height of the inside chimney to the position of the inside chimney bracket and fix on it with screws, after adjusting the position, fix the body with safety screws. Note: The two safety vents are positioned on the back housing, with diameter of 6mm. Lay the expansion pipe to the wall outlet. See pic 5.

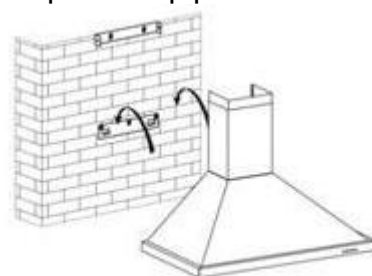

Pic4



Pic5

HINTS FOR EXHAUST DUCT INSTALLATION

The following rules must be strictly followed to obtain optimal air extraction:

- Keep expansion pipe short and straight.
- Do not reduce the size or restrict the expansion pipe.
- When using the expansion pipe always install the pipe pulled taut to minimize pressure loss.
- Failure to observe these basic instructions will reduce the performance and increase noise levels of the cooker hood.
- Any installation work must be carried out by a qualified electrician or competent person.
- Do not connect the ducting system of the hood to any existing ventilation system which is being used for any other appliance ,such as warmer tube, gas tube , hot wind tube.
- The angle of the bend of the expansion pipe should not be less than 120°; you must direct the pipe horizontally, or, alternatively, the pipe should go up from the initial point and should be led to an outer wall.
- After the installation ,make sure that the cooker hood is level to avoid grease collection at on end.
- Ensure the expansion pipe selected for installation complies with relevant standards and is fire retardant.

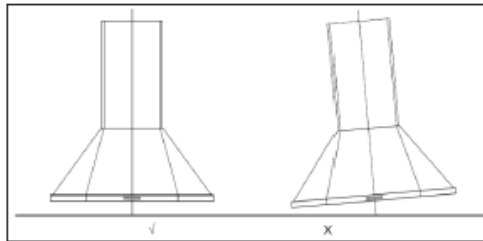

WARNING:



- For safety reason, please use only the same size of fixing or mounting screws which are recommended in this instruction manual.
- Failure to install the screws or fixing device in accordance with these instructions may result in electrical hazards.

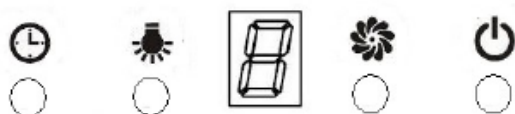

Start Using Your Cooker Hood

Electronic button with LED display



1. Power-on: After connecting the cooker hood to the main supply, the backlight of all buttons will turn on and the buzzer sounds for once. The LED display is closed . The cooker hood doesn't work and enters into stand-by mode.

2.  (Lamp) button:

Press  (Lamp) button, the lights will be on. Press again, the lights will be off. The above steps can be repeated operating. The lamp function could be operated without pressing the  (Power) button.

3.  (Power) button:

3.1 Press  (Power) button ,the cooker hood starts to work at the low speed and the LED display will display "1". Press again, the cooker hood will stop.The cooker hood speeds can only be adjusted when starting the power button.

3.2 After switching off the speeds of cooker hood by power button, when press the power button again to start-up the hood, motor will work at the speed before the last exit.

4.  (Speed) button:

The cooker hood has three speed levels ,they are low,mid,high, and the corresponding LED display will be"1","2","3".

4.1 After switching on the power button,the hood starts to work at low speed and the LED display will display "1".

4.2 Press  (Speed) button again when it works at low speed, the cooker hood works at mid speed and the LED display will display "2".

4.3 Press  (Speed) button again when it works at mid speed, the cooker hood at the high speed and the LED display will display "3".

4.4 During the working, you can touch  (Speed) button to change the speed circularly: "low→mid→high→low→mid……"

5.  (Timer) button:

The timer button is only used for the timer function when the hood is working. (Press the button will be invalid when the hood is under standby mode or open the lamp separately).

5.1 Press the timer button, the hood enter into the timer function. The timer setting is 9mins and the display shows “9”.





5.2 After the timing function starts, the display shows “9”, “8”, “7”..., decreasing by minute. After the timing is completed, the motor will automatically cut off the power immediately and the motor output will be turned off. The lights are off at the same time.

5.3 Press the timer button once to enter the timer function. Press again to exit the timer function. The above steps can be operated repeatedly. In the timing state, pressing the speed button  will automatically exit the timing function.

Connecting the remote control

- ✧ A New remote control has to establish a new connection to the cooker hood when used for first time. One remote control could possibly control several cooker hood at the same time.

Connection process between remote control and cooker hood

- ✧ Within 15S after the cooker hood connects to the power supply, long press  for 5 seconds, the indicators light begin flashing from one button to another ,the cooker hood is in connection mode, press any button on remote control to confirm the connection. The connection process finished and the remote control can be used for speed selection, lighting and timer setting.
- ✧ If you want to connect again, you will need to clear the code that has been set up previously.
- ✧ To clear the code, press  for 5 seconds, the indicators light begin flashing from one button to another, the cooker is in connection mode. Then, press  again for 5 seconds, the previous connection code is cleared.
- ✧ When the previous code has been cleared, the cooker hood back to standby mode, press  for 5 seconds, the indicate light flashing from one button to another ,the cooker hood is in connection mode, then, press any button on remote control to confirm the connection.

Remote control

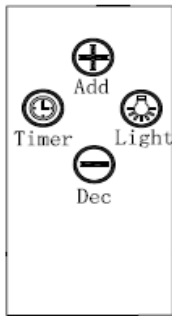



1. Lighting

 press button once, the light is on, press again, the light is off. The lighting button is controlled separately and will not affect any other functions.

2. Turning on/ Increasing motor speed button  , the motor has low, mid, high totally 3 levels.

2.1 Press  once, the motor will work at low speed (Turning on).

2.2 When the hood works at low speed, press  again, the motor changes to mid speed.

2.3 Base on the middle speed condition, press  again, the motor is running in the high speed.

2.4 Base on the high speed condition, press  again, the hood still works at high speed.

3. Turning off/Decreasing motor speed key 

3.1  press the button and the motor begins shift to a lower speed and the LCD screen display the speed level. Repeating press the button, it keep on decreasing the motor speed till the cooker hood turning off.

4. Low speed, mid speed and high speed cannot work at the same time. When hood is on high speed, press the speed decrease, it will turn to a lower speed; when it is in low speed, press the speed increase, it will turn to a higher speed.

5. Timer

 Press the button to set up the timer on/off function.



WARNING!

The coin cell battery in the remote control is hazardous and must be kept away from children (whether the battery is new or used).

If the battery is swallowed, or placed inside any part of the body, it can cause severe or fatal injuries in 2 hours or less.

Immediately seek medical attention or contact the Poisons Information Centre on 13 11 26 if it is suspected the battery has been swallowed or placed inside any part of the body.

Dispose used batteries immediately.

TROUBLESHOOTING

Fault	Possible Cause	Solution
Light on, but motor does not work	Fan switch turned off	Select a fan switch position.
	Fan switch failed	Contact service center.
	Motor failed	Contact service center.
Light does not work, motor does not work	House fuses blown	Reset/Replace fuses.
	Mains power cable is loose or disconnected	Refit mains power cable to power outlet. Switch power outlet on.
Oil leakage	One way valve and the outlet are not tightly sealed	Take down the one way valve and seal with sealant.
	Leakage from the connection of chimney and cover	Take chimney down and seal.
Lights not working	Broken or faulty bulbs	Replace bulbs as per this instruction.
Insufficient suction	The distance between the cooker hood and the gas top is too far	Refit the cooker hood to the correct distance.
The Cooker hood inclines	The fixing screw is not tight enough	Tighten the hanging screw and make it horizontal.

NOTE:



Any electrical repairs to this appliance must conform to your local, state and federal laws. Please contact the service centre if in any doubt before undertaking any of the above. Always disconnect the unit from the power source when opening the unit.

MAINTENANCE AND CLEANING

Caution:

- Before maintenance or cleaning is carried out, the cooker hood should be disconnected from the mains power supply. Ensure that the cooker hood is switched off at the wall socket and the plug removed.



- External surfaces are susceptible to scratches and abrasions, so please follow the cleaning instructions to ensure the best possible result is achieved without damage.

GENERAL

Cleaning and maintenance should be carried out with the appliance cold especially when cleaning. Avoid leaving alkaline or acid substances (lemon juice, vinegar etc.) on the surfaces.

STAINLESS STEEL

The stainless steel must be cleaned regularly (e.g. weekly) to ensure a long life expectancy. Dry with a clean soft cloth. A specialized stainless steel cleaning fluid may be used.

NOTE:

Ensure that wiping is done along with the grain of the stainless steel to prevent any unsightly crisscross scratching patterns from appearing.

CONTROL PANEL SURFACE

The inlay control panel can be cleaned using warm soapy water. Ensure the cloth is clean and well wrung before cleaning. Use a dry soft cloth to remove any excess moisture left after cleaning.

Important

Using neutral detergents and avoid using harsh cleaning chemicals, strong household detergents or products containing abrasives, as this will affect the appearance of the appliance and potentially remove any printing of artwork on the control panel and will void manufactures warrantee.

GREASE MESH FILTERS

The mesh filters can be cleaned by hand. Soak them for about 3 minutes in water with a mild detergent and then brush it gently with a soft brush. Do not apply too much pressure so as to avoid any damage to it . (Leave to dry naturally out of direct sun light)

Filters should be washed separately to crockery and kitchen utensils. It is advisable not to use rinse aid.

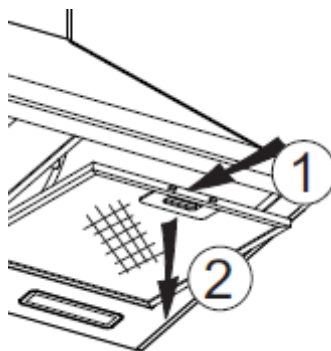

INSTALLING GREASE MESH FILTERS

- To install filters for the following four steps:
 - Angle the filter into the slots at the back of the hood.
 - Push the button on the handle of the filter.
 - Release the handle once the filter fits into a resting position.
 - Repeat to install all filters.

CARBON FILTER-not supplied

Activated carbon filter can be used to trap odors. Normally the activated carbon filter should be changed every 3 to 6 months according to your cooking habits. The installation procedure of activated carbon filter is as below:

1. Before installing or replacing the carbon filters, disconnect the mains power to the unit.
2. Press the filter lock and remove the mesh filter.
3. Turn the carbon filter on both sides of the motor anti-clockwise. Replace the carbon filters with the new carbon filters.
4. Place the mesh filter.
5. Connect the power supply to the wall socket.

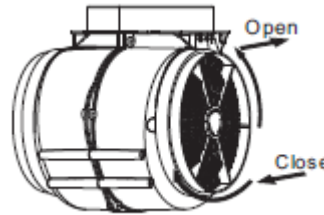

NOTE:

- Make sure the filter is securely locked. Otherwise, it would loosen and cause danger.
- When activated carbon filter attached, the suction power will be lowered.

BULB REPLACEMENT

<p>Important :</p> 	<ul style="list-style-type: none">✧ Always switch off the electricity supply before carrying out any operations on the appliance. When handling bulb, make sure it has completely cooled down before any direct contact with hands.✧ When handling bulbs hold with a cloth or gloves to ensure perspiration does not come in contact with the bulb as this can reduce the life of the bulb.
--	--

Note:

- Before changing the lights, make sure that the appliance is turned off and unplugged.
- Protect against danger when changing lights, such as wearing gloves.

Changing the lights:

- Remove the grease filter.
 - Use a tool or the hand to press the spring splinter of both sides of LED light to the inside, until the light is pressed out, see pic 1. Then slightly pull the light connecting wire out, and dismantle the terminal of the light connecting wire. See pic 2.
 - Apply the reverse procedure to install the light back.
- ILCOS D code for this lamp is: DSR-1.5/65-S-64
 - LED modules –round lamp
 - Max wattage: 2×1.5 W
 - Voltage range: DC 12V
 - Dimensions:

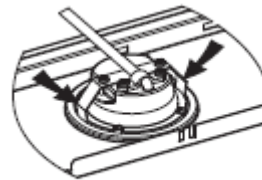
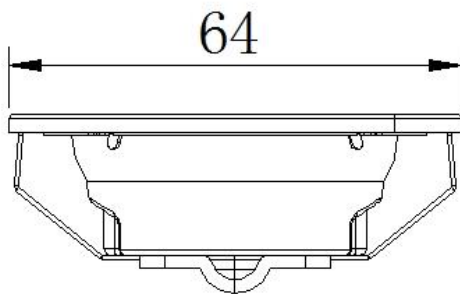

Pic 1



Pic 2

ENVIRONMENTAL PROTECTION:

	<p>This product is marked with the symbol on the selective sorting of waste electronic equipment. This means that this product must not be disposed of with household waste but must be supported by a system of selective collection in accordance with Directive 2012/19/EU. It will then be recycled or dismantled to minimize impacts on the environment, electrical and electronic products are potentially dangerous for the environment and human health due to the presence of hazardous substances. For more information, please contact your local or regional authorities.</p>
---	---

NOTE:

The following shows how to reduce total environmental impact (e.g. energy use) of the cooking process).

- (1) Install the cooker hood in a proper place where there is efficient ventilation.
- (2) Clean the cooker hood regularly so as not to block the airway.
- (3) Remember to switch off the cooker hood light after cooking.
- (4) Remember to switch off the cooker hood after cooking.

INFORMATION FOR DISMANTLING

Do not dismantle the appliance in a way which is not shown in the user manual. The appliance could not be dismantled by user. At the end of life, the appliance should not be disposed of with household waste. Check with your Local Authority or retailer for recycling advice.



Pronto Service + Support: 1800 440 335
Email: service@eurostylegroup.com.au

HEAD OFFICE

65 Glynburn Road, Glynde SA 5070
Ph: 08 8165 1012

www.euroappliances.com.au