



**Pronto** Service + Support: 1800 440 335  
Email: [service@eurostylegroup.com.au](mailto:service@eurostylegroup.com.au)

HEAD OFFICE  
65 Glynburn Road, Glyne SA 5070  
Ph: 08 8165 1012

[www.euroappliances.com.au](http://www.euroappliances.com.au)



laundry

USAGE AND  
CARE GUIDE

PRODUCT CODE:  
E7SDWH



# CONTENTS

---

## SAFETY INSTRUCTIONS

- Safety Instructions ..... 2

## INSTALLATION

- Product Description ..... 7
- Installation ..... 7

## OPERATIONS

- Quick Start ..... 9
- Before Each Drying ..... 10
- Control Panel ..... 11
- Drying Programmes Table ..... 11

## MAINTENANCE

- Cleaning And Care ..... 14
- Trouble Shooting ..... 15
- Technical Specifications ..... 16
- Product Fiche..... 17

# SAFETY INSTRUCTIONS

---

## ■ Safety Instructions

- The appliance is not intended for use by persons (including children) with reduced physical, sensory or mental capabilities, or lack of experience and knowledge, unless they have been given supervision or instruction concerning use of the appliance by a person responsible for their safety.
- Children should be supervised to ensure that they do not play with the appliance. In EN standard countries, this appliance can be used by children from 8 years and above and persons with reduced physical, sensory or mental capabilities or lack of experience and knowledge if they have been given supervision or instruction concerning use of the appliance in a safe way and understand the hazards involved. Children shall not play with the appliance, leaning and user maintenance shall not be made by children without supervision.
- The tumble dryer is not to be used if industrial chemicals have been used for cleaning.
- The lint trap must be cleaned frequently.
- Lint must not to be allowed to accumulate around the tumble dryer.
- The maximum mass of dry textile material is 7kg.
- Do not dry unwashed items in the tumble dryer.
- Items that have been soiled with substance such as cooking oil, acetone, alcohol, petrol, kerosene, spot removers, turpentine, waxes and wax removers should be washed in hot water with a extra amount of detergent before being dried in the tumble dryer. This will reduce, but not eliminate, the hazard.
- Items such as foam rubber (latex form), shower caps, waterproof textiles, rubber backed articles and clothes or pillows fitted with foam rubber pads should not be dried in the tumble dryer.
- Items such as foam rubber (latex form), shower caps,

## SAFETY INSTRUCTIONS

---

- Fabric softeners, or similar products, should be used as specified by the fabric softener instructions.
- The final part of a tumble dryer cycle occurs without heat (cool down cycle) to ensure that the items are left at a temperature that ensures that the items will not be damaged.

### **⚠ Warning!**

Never stop a tumble dryer before the end of the drying cycle unless all items are quickly removed and spread out so that the heat is dissipated.

- The exhaust air must not be discharged into a flue which is used for exhausting fumes from appliance burning gas or other fuels.
- The appliance must not be installed behind a lockable door, a sliding door or a door with a hinge on the opposite side, to that of the tumble dryer. In such a way that a full opening of the tumble dryer door is restricted.
- Oil-affected items can ignite spontaneously, especially when exposed to heat sources such as in a tumble dryer. The items become warm, causing an oxidation reaction in the oil. Oxidation creates heat. If the heat cannot escape, the items can become hot enough to catch fire. Piling, stacking or storing oil-affected items can prevent heat from escaping and so create a fire hazard.
- The appliance should not be overturned during normal use or maintenance.
- Remove all objects from pockets such as lighters and matches.

## SAFETY INSTRUCTIONS

---

- For appliances with ventilation openings in the base, that a carpet must not obstruct the openings.
- If the power cable is damaged, it must be replaced by the manufacturer, its service agent or similarly qualified persons in order to avoid a hazard.
- Children of less than 3 years should be kept away unless continuously supervised.
- Plug must be accessible after installation.

# SAFETY INSTRUCTIONS

## • Power supply and grounding

The dryer employs alternative current with the rated voltage and frequency. When the voltage fluctuates between 6% of rated voltage, the dryer can work normally.

A special power socket with a capacity  $\geq 10A$  for the dryer had better be set beside the dryer for convenience and safety. The method of connection of the socket is as the figure below.

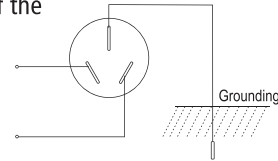

To be safe, please make improvements as soon as possible according to the rules and suggestions mentioned above.

### ⚠ Warning!

The socket and the grounding wire must be installed by an electrician to prevent incorrect installation or use of the socket and to guarantee the safety of use of electricity. No connection of the grounding wire and the neutral wire, otherwise the cabinet will be charged, which is likely to cause the danger of electric shock.

## • Precautions

Install or store where it will not be exposed to temperatures below freezing or exposed to water or weather, which could cause permanent damage and invalidate the warranty.

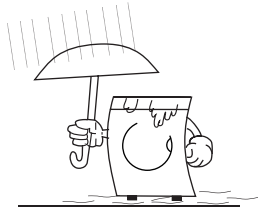

Keep area around the exhaust opening and adjacent surrounding areas free from the accumulation of lint, dust and dirt. An obstructed port might reduce the airflow.

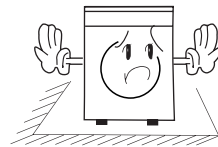

Thoroughly spin the laundry in washing machine. High spin speed can reduce the drying time and save energy consumption.

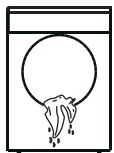

Make sure combustible sprayer will not be close to dryer when it is working, and once the gas leaks, do not touch plug or start/pause on it.

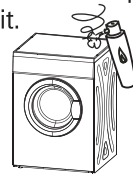

# SAFETY INSTRUCTIONS

Do not wash or dry articles that have been cleaned in, washed in, soaked in or spotted with combustible or explosive substances (such as wax, oil, paint, gasoline, degreasers, dry-cleaning solvents, kerosene, etc.).

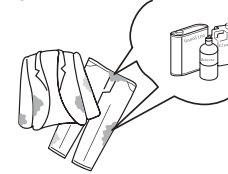

Never attempt to operate this appliance if it is damaged, malfunctioning, partially disassembled, or has missing or broken parts, including a damaged cord or plug.



Do not allow children on or in the appliance. Close supervision of children is necessary when the appliance is used near children.

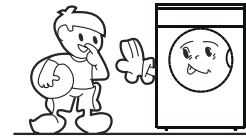

Please do not use the machine when your foot or hand with water.

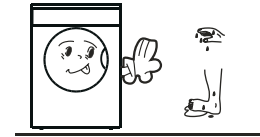

Do not store plastic, paper or clothing that may burn or melt on top of the dryer during operation.



The exhaust air must not be discharged into a flue which is used for exhausting fumes from appliance burning gas or other fuels.

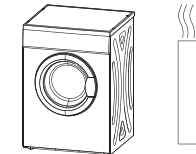

Do not dry articles containing rubber, plastic or similar materials such as padded bras, tennis shoes, galoshes, bath mats, rugs, bibs, baby pants, raincoat plastic bags or pillows that may melt or burn. Some rubber materials, when heated, can under certain circumstances produce fire by spontaneous combustion.



The door can be opened only after the programme of the drying machine is completed. Do not open the door before the programme finished to avoid the human skin from being scalded by hot steam or over heated drying machine.

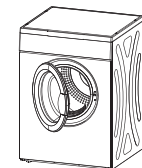

# INSTALLATION

## ■ Product Description

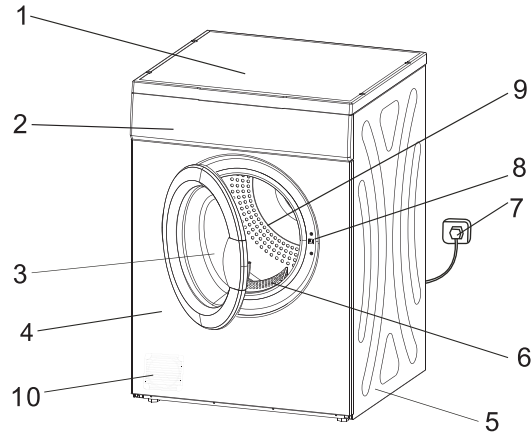

1.Top board 2.Control panel 3.Door 4.Front panel 5.Side panel 6.Filter  
7.Power plug 8.Switch 9.Tumbling box 10.Front vent flange

## ■ Installation

- Dryer should be placed in a ventilated area with not less than 10cm distance from the wall. It is suggested there are no obstacles within 1.5m in front of dryer and keep ventilated.

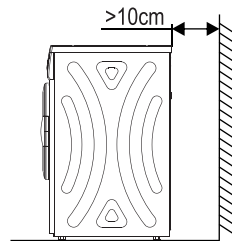

# INSTALLATION

- The horizontal adjustment:  
Tie a heavy subject on the string on the front and two sides of the dryer. Please refer this to below figure, and if A=A, B=B, this means the dryer is placed horizontally. While the opposite, you could place something on the grounding.

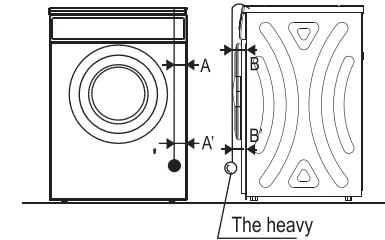

Notice:  
if dryer could not be placed horizontally (the lean angle is no more than 2), the dryer will work unbalanced or stop working sometimes.

Notice when installing:

- Do not install the dryer in the open air or place easily damaged by rain;
- Do not place the back of dryer near curtain or something in the wind;
- Do not place the dryer near gas or flammable area.

# INSTALLATION

## The Specification of the dryer installation on the wall

Attached spare part for installation on the wall

No.	Name	Quantity	Picture
1	Horizontal Screw Position Template	1	
2	Expansion Screw bolt	4	
3	Hook	2	
4	Plastic Cover	2	
5	Inverted Control Panel Decal	1	

### 2. Hanging Procedure:

Step 1: Confirm that all components are in the Accessory Kit

Step 2: Determine the wall construction and a suitable position for dryer installation

a. Dryer should only be attached to a solid wall.

b. The clearance distance in front of the wall must be more than 150cm.

Step 3: Paste the installation positioning paper to the solid wall.

a. The bottom edge of the positioning paper must be at least 45cm higher than the floor. Draw a line with a level, as a base for the positioning paper. (Note: Ensure the marked screw holes do not overlap with nearby power outlets or taps.)

b. Remove the adhesive paper from the back of the positioning paper, and paste the positioning paper to the wall horizontally.

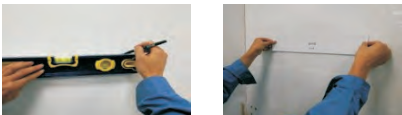

Step 4: Drill holes for anchor bolts. Find the hole mark on the positioning paper and using a 14mm drill bit drill 4 holes according to the positioning paper drawing (hole depth 60mm). Use an appropriate 14mm drill bit to pre-drill

# INSTALLATION

in tiled walls.



Step 5: Fix the hook to wall with an anchor bolt.

a. Using the anchor bolt from the Accessory Kit, insert the anchor bolt and tube into the drilled holes. Attach one nut to each bolt. To prevent the thread being damaged, don't expose the end-thread of the bolt. Hammer the 4 bolts into the holes.



b. After the bolts are hammered into the wall, remove the nuts and expose the bolts. Place a suitably sized auxiliary tube over the bolt, and hammer the tube until the anchor tube is flush with the wall surface.



c. Remove the hooks from the Accessory Kit and attach to the bolts with a socket or a wrench.

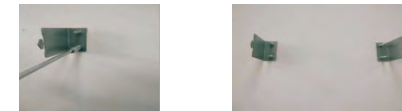

Step 6: Fix the standoffs to the clothes dryer. Place the unpackaged clothes dryer on the floor. Remove the appropriate two screws at the back of the appliance with a Phillips head screwdriver. Thread the screws through the holes in the standoffs and then fasten them into the original screw holes



Step 7: Have 2 people lift the clothes dryer and align the slots at the back of the dryer with the hooks. Insert the hooks firmly into the slots and lower dryer onto hooks.

Step 8: If necessary, fit the inverted control panel label over the existing control panel label.

**WARNING:** To avoid possible injury use two or more people to move and install the dryer.

# OPERATIONS

## Quick Start

### Note!

Before using, please make sure it's installed properly.

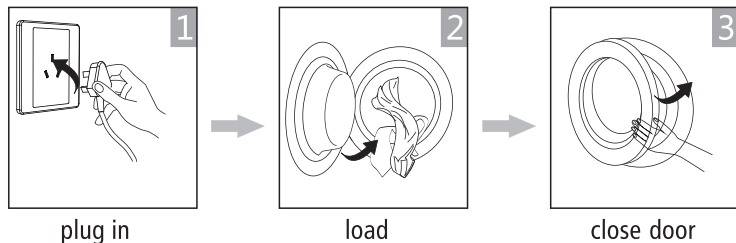

## Drying

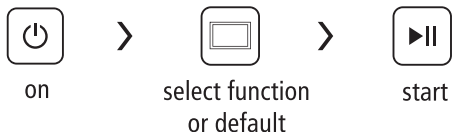

## After Drying

Buzzer beep or "0:00" on display.

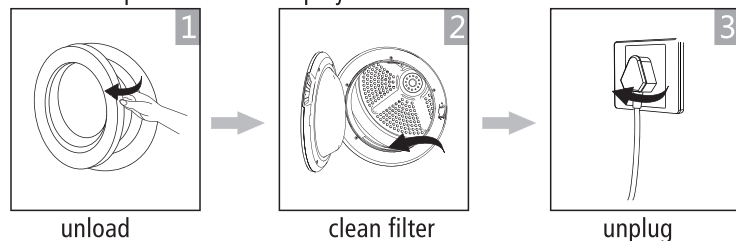

# OPERATIONS

## Before Each Drying

1. Before drying, thoroughly spin the laundry in washing machine. High spin speed can reduce the drying time and save energy consumption.
2. For uniform drying result, sort the laundry according to fabric type and drying programme.
3. Before drying, please close zips, hooks and eyelets, button up, tie fabric belts, etc.
4. Do not over dry the clothes, because over dried clothes can easily get creases.
5. Do not dry the articles containing rubber or similar elastic materials.
6. The door can be opened only after the programme of the drying machine is human skin from being scalded by hot steam or over heated drying machine.
7. Clean the lint filter and empty container after each use to avoid extension of drying time and energy consumption.
8. Do not dry these clothes after dry-clean process.

The reference weight of dry clothes (each)

Mixed-fabric clothes (about 800g)	Jacket (about 800g cotton)	Jeans (about 800g)	Towel quilt (about 900g cotton)
Single bedsheet (about 600g cotton)	Work clothes (about 1120g)	Sleepwear (about 200g)	Long sleeve shirt (about 300g cotton)
Short sleeve shirt (about 180g cotton)	Short pants (about 70g cotton)	Socks (about 50g mixed-weave)	

### Note!

- Never overload.
- Not for textile with dropping water. The dryer could be damaged, even fire.
- Not suitable for silk or woolen textiles.

Please pay attention to use the drying machine if the materials of your clothes can not be dried by it or contain the symbols as follows:

Dry	Normal	Not tumble dry normal	Do not dry
Line dry / hang to dry	Drip dry	Dry flat	In the shade
Dry clean	Do not dry clean	Dry clean normal cycle with any solvent	Dry clean normal cycle petroleum solvent only

# OPERATIONS

## Control Panel

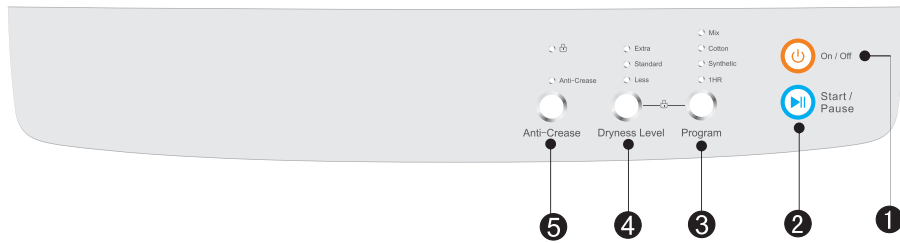

### 1 On/Off

Product is switched on or off.

### 2 Start/Pause

Press the button to start or pause the drying cycle.

### 3 Programmes

Different Dryer cycle can be selected according to the user's needs to make the clothes have more effective drying results.

### Note!

- Press the **【Program】** button to select the desired programme.
- Press the **【Dryness Level】** button to select the desired programme.
- Press the **【Anti-Crease】** button to start Anti-Crease function.
- Press the **【Start/Pause】** button.
- Press the **【Delay】** button to booking the drying process.
- If users need child lock function, pressing the **【Program】** and **【Dryness Level】** buttons simultaneously for over 3 seconds to start child lock function.
- The buzzer will prompt from the dryer when finishing the cycle. Press the **【On/Off】** button and pull out the power cable.
- Clean the filter, cabinet and inner tube.
- Clean the filter when the "Filter" light is flashing, after the dryer stop.

# MAINTENANCES

## Drying Programmes Table

Clothing Type	Approximate amount of remaining humidity	Capacity (KG)	Programs	Dryness Level	Note
Cotton	80%-90%	7	Cotton	Extra	Please according to the Type and Capacity of the clothing to select the most suitable Program and Dryness Level.
	60%-70%	7 / 3.5	Cotton	Standard	
		7	Cotton	Less	
Mix	70%	7 / 3.5	Mix	Extra	
	60%	7 / 3.5	Mix	Standard	
Synthetic	50%	3.5	Synthetic	Extra	
	40%	3.5	Synthetic	Standard	
Cotton	—	1	1Hr	—	

- Note: 1.Cold wind function means there is only cold wind for circulating before finishing heating 3 minutes.(Except 1 hour program which runs 10 minutes cold wind.)
- 2.If Anti-Crease option is selected, the anti-crease process will enlarge to 2 hour, otherwise it keeps 30min without this option.
- 3.The inside temperature and humidity will affect drying time.
- 4.Check the label attached on clothes and choose the right temperature and time according to the explanation.
- 5."Cotton + Extra" is for AS/NZS energy program.
- Suggestion: When clothes is less than 0.5kg, please select an hour dry and Extra for drying.



# MAINTENANCES

## ■ Cleaning And Care

### Filter clean

- Clean the lint filter after each use. Remove by pulling straight up.
- Cleaning filter Use wiping cloth or your fingers.
- Install filter If the filter is cleaned by damp cloth or water, please install after the sun dry.

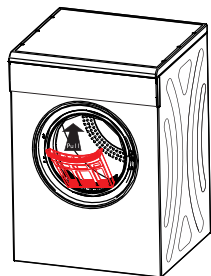

### Cleaning cabinet and inner tube

- Use soft damp cloth wipe when cleaning cabinet and inner tube.
- Not to rinse by water direct.
- Not to use neutral scour wipe.
- Not to use gasolene and alcohol wipe.
- Make sure open the front door for aeration after cleaning the inner tube.

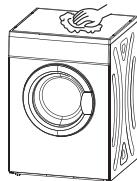

### Safety reset

1. These dryers have a safety cut out switch which is activated by temperature.
2. The safety reset button is on the backboard. If your dryer not heating this button must be reset before the dryer can heat again. You may need to wait 10 minutes for cooling down.
3. The most common reason for the dryer if overheat is a blocked filter.
4. Clean the line filter after each load to prevent overheating of the dryer

The cut out switch may operate for the following reasons:

1. Lint filter is blocked.
2. Exhaust outlets blocked at the back of the dryer.
3. Poor ventilation in the laundry or room-open a window or door
4. Lightweight garment eg. handkerchief, sucked over the filter.

# MAINTENANCES

### Safety Reset Button

Use your finger or a pencil to press the button in until you feel it click.

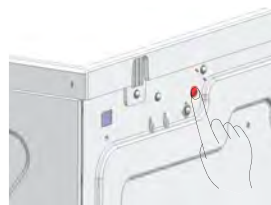

## ■ Trouble Shooting

Trouble	Cause	Solution
Will not start	<ul style="list-style-type: none"> <li>• Power cut.</li> <li>• The power plug is not plugged tight.</li> <li>• Dry clothes exceed.</li> <li>• The temperature fuse is cut.</li> </ul>	<ul style="list-style-type: none"> <li>• Wait for switching on electricity.</li> <li>• Check the power socket, make sure plug tight.</li> <li>• The clothes in drier must be after spinning, and drying clothes can not exceed 7kg.</li> <li>• Please career man restore the temperature fuse.</li> </ul>
External hot or can smell hot	<ul style="list-style-type: none"> <li>• The lint filter is dirty.</li> <li>• The uptake or exhaust duct is dirty.</li> </ul>	<ul style="list-style-type: none"> <li>• Make sure clean the lint filter in time.</li> <li>• Clean out the stem.</li> </ul>
Clothes too dry	<ul style="list-style-type: none"> <li>• The clothes in machine are too full.</li> <li>• Not to take out the clothes in time when finish.</li> <li>• The clothes don't assort properly.</li> <li>• The temperature is enacted too high.</li> </ul>	<ul style="list-style-type: none"> <li>• Make sure the clothes are not too full.</li> <li>• Take out the clothes immediately when finish. See page 7.</li> <li>• Observe the maintenance label on clothes.</li> <li>•</li> </ul>
Clothes shrink	<ul style="list-style-type: none"> <li>• Too dry.</li> </ul>	<ul style="list-style-type: none"> <li>• Observe the maintenance label on clothes. if easy to shrink, should examine the clothes when dry. Take out the clothes when tiny damp for too dry. Then hang the clothes until full dry.</li> </ul>
Hairball on clothes	<ul style="list-style-type: none"> <li>• It is right for synthetic fibre and permanent press fibre causing hairballs. This is because the right rub causing.</li> </ul>	<ul style="list-style-type: none"> <li>• Use fabric softener lubricate fibre, please spray settled gule on cuff and neckline when iron clothes. Turn the sarcenet out for reducing rub.</li> </ul>

# MAINTENANCES

- The sound of dryer when runs can cause  
Due to heavy wet clothes' turning and bumping, and this will cause noise accordingly.
- Air bumping: When drying, machine will generate steam which will come out from pipe and this will cost bumping with the bottom of inner tub.

Error code	description	Criteria	Action after fault debounced	Failure indication
E1	Over-temperature	NTC or PCB fault	Stop the program and go to fault state	Led less flashing
E3	Temperature Sensor error	Temperature Sensor is open or PCB fault	Stop the program and go to fault state	Led less and standard flashing
E4	Temperature Sensor error	Temperature Sensor is short or PCB fault	Stop the program and go to fault state	Led extra flashing

## ■ Technical Specifications

Model	E7SDWH
Parameter	
Dimension (L*W*H)	555*595*840(mm)
Rated input power	2000W
Rated voltage	220-240V~
Rated frequency	50Hz
Weight of product	35kg
Rated capacity	7.0kg
Ambient temperature	+5°C~+35°C

### 🔧 Note!

- The rated capacity is the maximum capacity, make sure that the dry clothes which are loaded to the appliance do not exceed the rated capacity each time.
- Do not install the tumble dryer in a room which the temperature around freezing point, and will have a risk of frost occurring, the tumble dryer may not be able to operate well.