

# DWAU6315X3



Product Family	Dishwashers
Commercial width	60 cm
Commercial height	82 cm
Installation	Under counter built-in
N° baskets	3, Flexi
Motor	Single phase
EAN code	8017709297176



## Programs / Functions



N. of programmes	5+5 quick programmes	Delicate and Quick	Yes
Washing temperatures	45, 50, 65, 70 °C	Daily Quick	Yes
Soak	Yes	Auto 60-70	Yes
Rapid 27'	Yes	Strong and fast	Yes
Ultraclean	Yes	Regular	Yes
Regular Quick	Yes	Normal ECO	Yes

## Options



Enersave option	Yes	Options for tabs FlexiTabs	Yes
Delay timer option	Up to 24 hours	Quick Time option	Yes
1/2 load FlexiZone option	Yes		

## Baskets



Basket colour	Grey	Largest loadable dish in upper basket	19,0 cm
Basket components colour	Grey	Lower Basket	With completely foldable racks and glass holder
Handle	In plastic with stainless steel insert on upper and lower basket	Lower basket with anti-drip inserts	Yes

<b>Upper Basket</b>	With central fixed racks	<b>Largest loadable dish in lower basket</b>	30,0 cm
<b>Height adjustment of the upper basket</b>	On three levels	<b>Colour Inner Components</b>	Blue
<b>Upper basket with EasyGlide System</b>	Yes	<b>Cutlery basket</b>	13 place settings sliding

## Technical Features



<b>Width (mm)</b>	598 mm	<b>Max water hardness</b>	100°FH;58°dH
<b>Depth (mm)</b>	570 mm	<b>Drying system</b>	Natural condenser drying, with EnerSave automatic door opening system at the end of the cycle
<b>Display type</b>	LED (external)	<b>Steam protection</b>	In plastic
<b>Product Height (mm)</b>	818 mm	<b>Tube material</b>	Stainless steel
<b>Controls</b>	Electronic	<b>Filter</b>	Stainless steel
<b>Display</b>	Delayed start, Programme time indicator, Time to end indication	<b>Concealed heating element</b>	Yes
<b>Programme graphics</b>	Symbols	<b>Hinges</b>	Self balancing with fixed hinges
<b>Rinse aid indicator</b>	Light	<b>Min. and max plinth height</b>	100 - 170 mm
<b>Progress indicator</b>	Yes	<b>Adjustable feet</b>	7cm, from 820 to 890 mm
<b>End of cycle indicator</b>	On display, with acoustic signal	<b>Additional gaskets</b>	Yes, with stainless steel plate
<b>Washing system</b>	Orbital	<b>Back cover</b>	Yes
<b>Third spray arm</b>	Single	<b>Depth of dishwasher with open door (mm)</b>	1146
<b>Turbidity sensor</b>	Yes	<b>Adjustable plinth</b>	By height and depth
<b>Aquatest</b>		<b>Top cover</b>	In plastic
<b>Flood protection system</b>	Total Acquastop		
<b>Water supply</b>	Single; cold/hot water max. 60°C - energysave with hot water up to 35%		

## Electrical Connection

<b>Plug</b>	(I) Australia	<b>Frequency (Hz)</b>	50 Hz
<b>Connected power</b>	1800 W	<b>Type of connection</b>	Single-phase
<b>Current</b>	10 A	<b>Power supply cable length</b>	140 cm
<b>Voltage</b>	220-240 V		

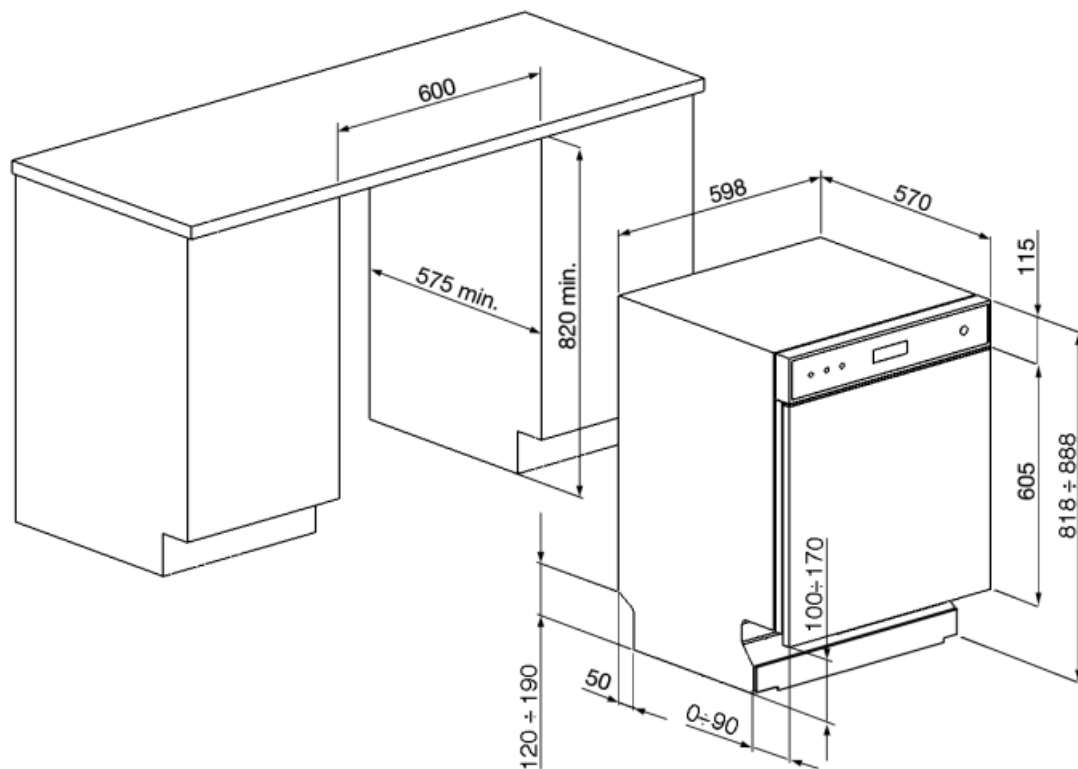

---

## Not included accessories

---

### KITPL60FABB



Toe kick Kit in White colour with adjustable height. Can be fitted over all the fully integrated and underbench models with Fixed Fulcrum. Can be installed also on the models with variable fulcrum or flexifit hinges.

### KITPL60FABN



Toe kick Kit in Black colour with adjustable height. Can be fitted over all the fully integrated and underbench models with Fixed Fulcrum. Can be installed also on the models with variable fulcrum or flexifit hinges.

### KITGH

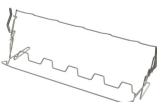

Kit glass holder. It has to be fitted on the first basket but only if there are foldable racks

### KITPL60FABX

















Toe kick Kit in Stainless Steel with adjustable height. Can be fitted over all the fully integrated and underbench models with Fixed Fulcrum. Can be installed also on the models with variable fulcrum or flexifit hinges.

### KITPLV2



Kit extension for dishwasher and washing machine: lenght mt. 2

## Symbols glossary (TT)

	Aquatest measures the clarity of the water during an auto program, and automatically ensures the minimum consumption of water and energy.		Anti-drip: Some models of dishwashers are equipped with special polymer nozzles anti-drip, that improve the process of drying.
	COMM_HEIGHT_82_72dpi		Delay Timer: The delay timer can postpone the start of the program by up to 24 hours.
	LED display: to show programmes, functions and options selected and the time to the end of the cycle.		EasyGlide: Convenient EasyGlide system for easy unloading of the appliance that allows reaching maximum flexibility of load of the machine.
	Flexitabs: Flexitabs adjusts the wash cycle to give the best possible results regardless of the type of detergent used.		FlexiZone: The 1/2 load flexizone allows you to wash a reduced load saving energy, water and time and there are no restrictions on where the items are placed.
	Noise Level: Excellent insulation and special devices keep noise to a minimum.		Orbital wash system distributes water evenly throughout the 60cm dishwasher cavity, directing water with precision to ensure an excellent wash.
	Auto 60° - 70°: The auto program regulates the length of a cycle depending on the need for a pre-wash and the number of rinses required.		Daily Quick: The daily program is suitable for quick daily washing of dishes.
	Delicate Quick: Program Delicate Quick is suitable for quick washing of delicate dishes.		Eco: Eco, this economic wash programme uses a low amount of water and energy in order to provide the most environmentally friendly cleaning option.
	Soak programme: The soak programme provides a rinse to prevent dirt from drying.		Strong&Fast: This special programme takes less than 1 hour to eliminate the most stubborn dirt and dried on residues.
	The symbols show the number of plate settings of the dishwasher.		Total Acquastop: In addition to the partial Acquastop protection present in all Smeg dishwashers, some models have an electronic device fitted to the water intake hose, which monitors water levels in the machine, detects leaks in the hose and switches off the water supply immediately when necessary.
	...		