

kitchen collection

Instructions for use and warranty details

To register your warranty or make a warranty claim, scan this QR code:



Dishwasher
Model No.: DW6030

 **kLEENmaid**

Dear Customer,

Thank you and congratulations for choosing Kleenmaid.

Your new appliance has been designed and meticulously tested to ensure that it meets all your culinary requirements, and has been carefully manufactured using top quality materials to give you years of reliable performance.

For best results, carefully read the instructions on how your new appliance is to be installed. Correct installation will avoid delays and unnecessary service call costs.

Once installation is complete, please read this instruction manual carefully and get to know the controls and the features of your new Kleenmaid appliance. These simple instructions will enable you to achieve excellent results from the very first time you use it.

Again, congratulations and thank you for choosing The Best You Can Own.

KLEENMAID

Please read this manual carefully before using the dishwasher and keep this manual for future reference. The latest version of this manual is available on our website. (See back page for details.)

CONTENTS

This manual is in two parts:-

Part 1 General Care and Installation

Part 2 Detailed Operating Instructions

PART 1 General Care and Installation

01	2	QUICK USER GUIDE
	3	SAFETY INFORMATION
02	8	PRODUCT OVERVIEW
	9	USING YOUR DISHWASHER
03	9	Basket Use Tips
	11	MAINTENANCE AND CLEANING
04	11	External Care
	11	Internal Care
	14	Caring For The Dishwasher
	15	INSTALLATION INSTRUCTION
	15	About Power Connection
05	16	Water Supply And Drain
	17	Connection Of Drain Hoses
	18	Position The Appliance
	18	Free Standing Installation
	19	Under Work Top Installation
06	20	TROUBLESHOOTING TIPS
07	24	LOADING THE BASKETS ACCORDING TO AS/NZS 2007.1

PART 2 Detailed Operating Instructions

01	2	USING YOUR DISHWASHER
	2	Control Panel
	5	Preparing And Loading Dishes
	8	Function Of The Rinse Aid And Detergent
	9	Filling The Rinse Aid Reservoir
02	10	Filling The Detergent Dispenser
	11	PROGRAMMING THE DISHWASHER
	11	Wash Cycle Table
	12	Starting A Cycle Wash
03	12	Changing The Program Mid-cycle
	13	Forget To Add A Dish?
	14	ERROR CODES
04	15	TECHNICAL INFORMATION

NOTE:

- Reviewing the section on Troubleshooting Tips will help you solve some common problems by yourself.
- If you cannot solve the problems by yourself, please ask for help from a professional technician.
- The manufacturer, following a policy of constant development and updating of the product, may make modifications without giving prior notice. The current user manual is available from the manufacturer's website.

01 QUICK USER GUIDE

Please see the corresponding sections of the instruction manual for operating details.

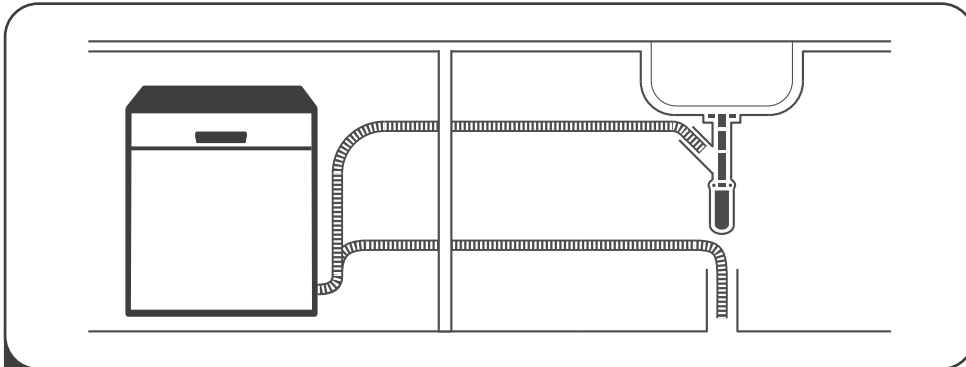

- 1 Install the dishwasher
Please check PART 1 section 05 "INSTALLATION INSTRUCTIONS"



- 2 Removing the larger residue on the dishes and cutlery

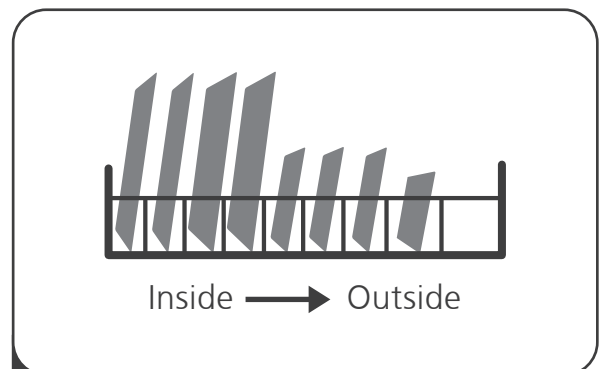

- 3 Loading the baskets

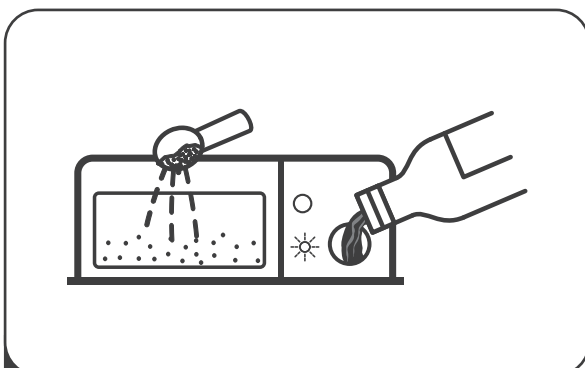

- 4 Filling the dispenser



- 5 Selecting a program and running the dishwasher

SAFETY INFORMATION

⚠ WARNING

When using your dishwasher, observe the precautions listed below:

- This appliance is intended to be used in household and similar applications such as:
 - staff kitchen areas in shops, offices and other working environments;
 - farm houses;
 - by clients in hotels, motels and other residential type environments;
 - bed and breakfast type environments.
- This appliance is not intended for use by persons (including children) with reduced physical, sensory or mental capabilities, or lack of experience and knowledge, unless they have been given supervision or instruction concerning use of the appliance by a person responsible for their safety.
- Children should not play with the appliance. Cleaning and user maintenance should not be done by children without supervision.

- Packaging material could be dangerous for children!
- This appliance is for indoor household use only.
- To protect against the risk of electrical shock, do not immerse the unit, cord or plug in water or other liquid.
- Please unplug before cleaning and performing maintenance on the appliance.
- Use a soft cloth moistened with mild soap, and then use a dry cloth to wipe it again.

Earthing Instructions

- This appliance must be earthed. In the event of a malfunction or breakdown, earthing will reduce the risk of an electric shock by providing a path of least resistance for electric current. This appliance is equipped with an earthing conductor plug.
- The plug must be plugged into an appropriate outlet that is installed and earthed in accordance with all local codes and ordinances.
- Improper connection of the equipment-earthing conductor can result in the risk of an electric shock.
- Check with a qualified electrician or service representative if you are in doubt whether the appliance is properly grounded.

- Do not modify the plug provided with the appliance. If it does not fit the outlet have a proper outlet installed by a qualified electrician.
- Do not abuse, sit on, or stand on the door or dish rack of the dishwasher.
- Do not operate your dishwasher unless all enclosure panels are properly in place.
- Open the door very carefully if the dishwasher is operating as there is a risk of water squirting out.
- Do not place any heavy objects on or stand on the door when it is open. The appliance could tip forward.
- When loading items to be washed:
 - 1) Locate sharp items so that they are not likely to damage the door seal;
 - 2) Warning: Knives and other utensils with sharp points must be loaded in the basket with their points facing down or placed in a horizontal position.
- Some dishwasher detergents are strongly alkaline. They can be extremely dangerous if swallowed. Avoid contact with the skin and eyes and keep children away from the dishwasher when the door is open.
- Check that the detergent powder dispenser is empty after completion of the wash cycle.

- Do not wash plastic items unless they are marked “dishwasher safe” or the equivalent.
- For unmarked plastic items not so marked, check the manufacturer's recommendations.
- Use only detergent and rinse agents recommended for use in an automatic dishwasher.
- Never use soap, laundry detergent, or hand washing detergent in your dishwasher.
- The door should not be left open, since this could increase the risk of tripping.
If the supply cord is damaged, it must be replaced by the manufacturer or its service agent or a similarly qualified person in order to avoid a hazard.
- During installation, the power supply must not be excessively or dangerously bent or flattened.
- Do not tamper with controls.
- The appliance needs to be connected to the main water valve using new hose sets. Old sets should not be reused.
- To save energy, in stand by mode , the appliance will switch off automatically while there is no any operation in 30 minutes .

Disposal

- To dispose of packaging and the appliance please go to a recycling centre. For safety, cut off the appliance power supply cable and disable the door closing device.
- Cardboard packaging is manufactured from recycled paper and should be disposed in the waste paper collection for recycling.
- By ensuring this product is disposed of correctly, you will help prevent potential negative consequences for the environment and human health, which could otherwise be caused by inappropriate waste handling of this product.
- For more detailed information about recycling of this product, please contact your local council office and your household waste disposal service.
- **DISPOSAL: Do not dispose this product as unsorted municipal waste. Collection of such waste separately for special treatment is necessary.**

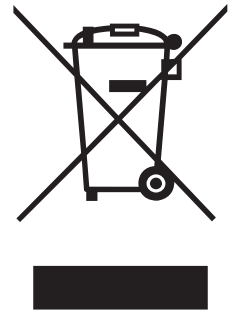

02 PRODUCT OVERVIEW

❗ IMPORTANT:

To get the best performance from your dishwasher, read all operating instructions (Part 1 and Part 2) before using it for the first time.

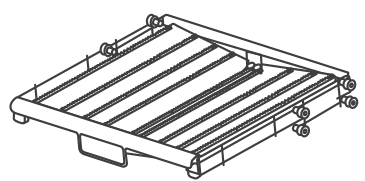
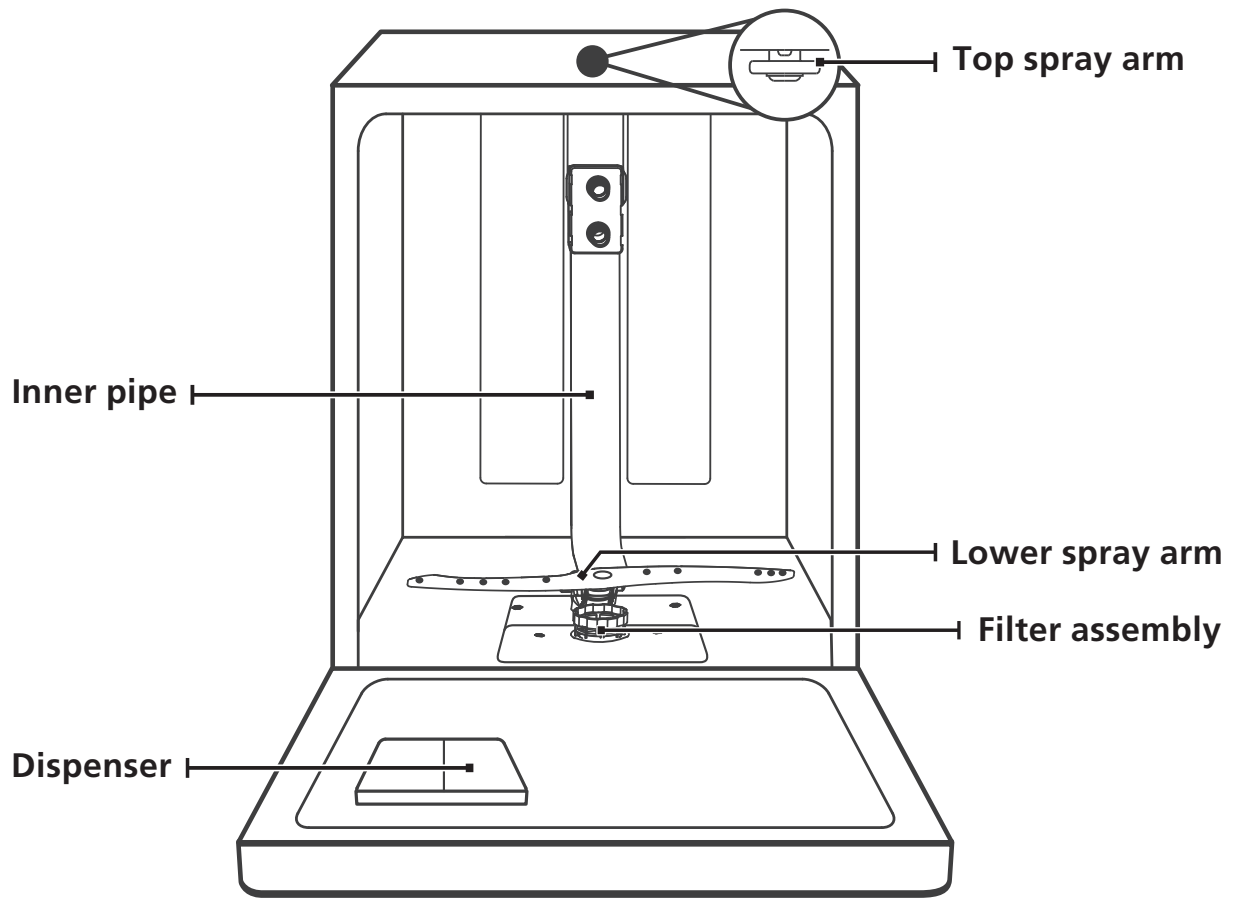

Cutlery rack

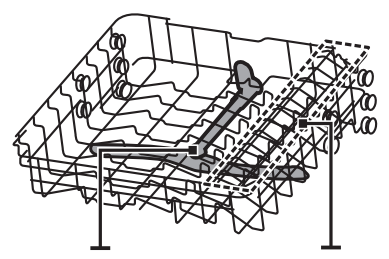

Upper spray arm Cup rack

Upper basket

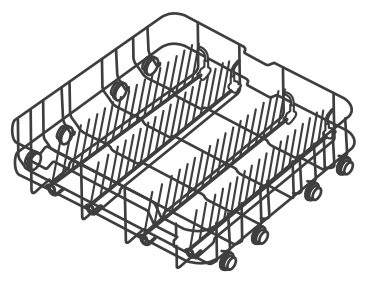

Lower basket

💡 NOTE:

Pictures are only for reference. Please check Part 2 for information specific to DW6030.

03 USING YOUR DISHWASHER

Before using your dishwasher :

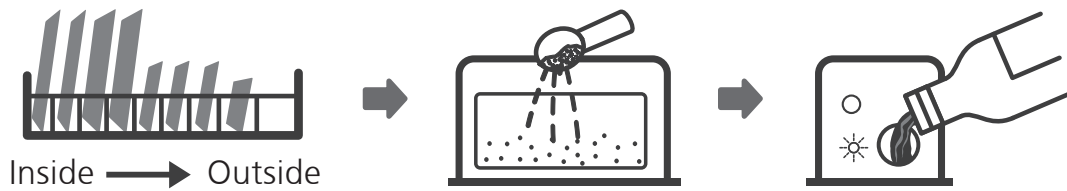

1. Loading the basket
2. Fill the rinse aid dispenser (Please check Part 2 Section 1)
3. Fill in detergent (Please check Part 2 Section 1)

Basket Use Tips

Adjusting the upper basket

The height of the upper basket can be easily adjusted to accommodate taller dishes in either the upper or lower basket.

To adjust the height of the upper rack, follow these steps:

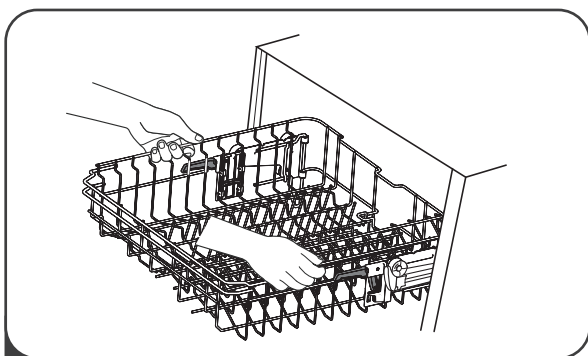

- 1 To raise the rack to the upper position, lift rack until both sides are at the same height. The rack will click into place.

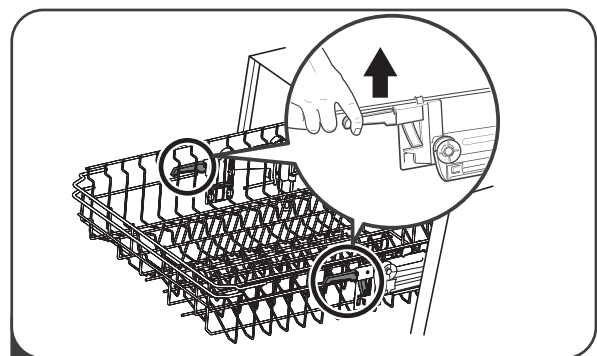

- 2 To lower the rack, push down on the handle and release.

Folding back the cup shelves

To make room for taller items in the dishwasher basket, raise the cup rack upwards. You can then lean the tall glasses against it. You can also remove it when it is not required for use.

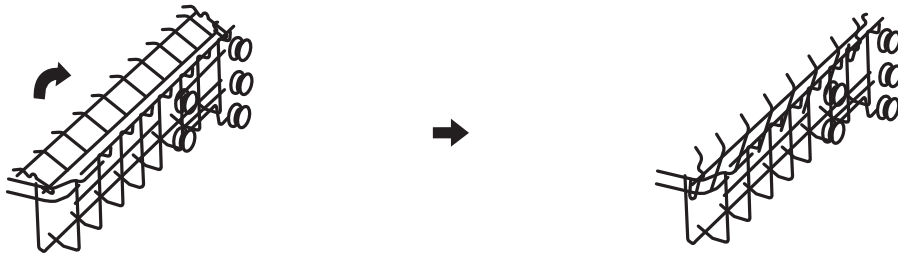

Folding back the rack shelves

The spikes are used for holding plates. They can be lowered to make more room for large items.

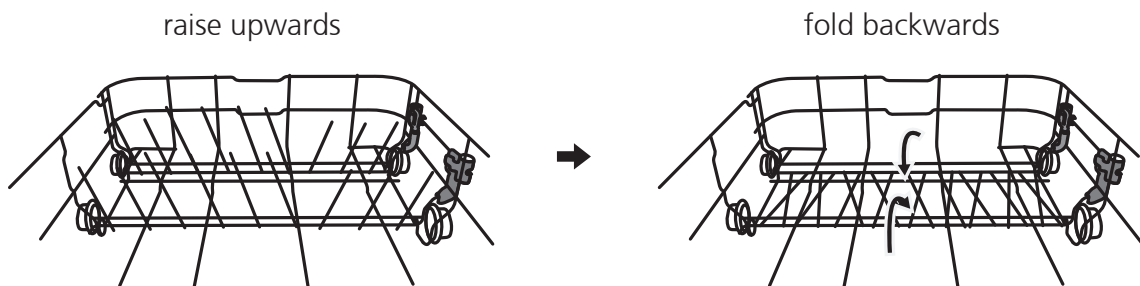

04 MAINTENANCE AND CLEANING

External Care

The door and the door seal

Clean the door seals regularly with a soft damp cloth to remove food deposits. When the dishwasher is being loaded, food and drink residues may drip onto the sides of the dishwasher door. These surfaces are outside the wash cabinet and are not accessed by water from the spray arms. Any deposits should be wiped off before the door is closed.

The control panel

If cleaning is required, the control panel should be wiped with a soft damp cloth ONLY.

⚠ WARNING

- To avoid penetration of water into the door lock and electrical components, do not use a spray cleaner of any kind.
- Never use abrasive cleaners or scouring pads on the outer surfaces because they may scratch the finish. Some paper towels may also scratch or leave marks on the surface.

Internal Care

Filtering system

The filtering system in the base of the wash cabinet retains coarse debris from the washing cycle. The collected coarse debris may cause the filters to clog. Check the condition of the filters regularly and clean them if necessary under running water. Follow the steps below to clean the filters in the wash cabinet.

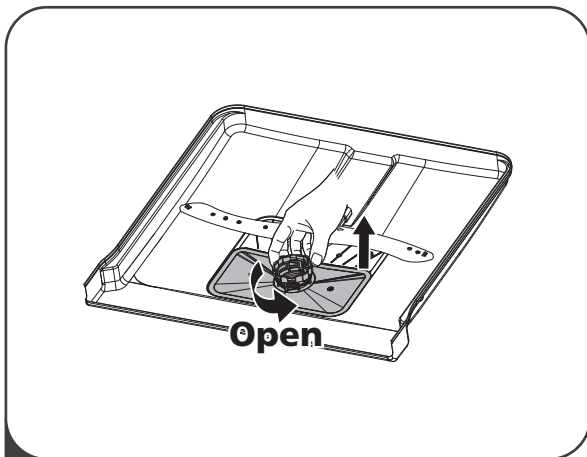

1 Hold the coarse filter and rotate it anticlockwise to unlock the filter. Lift the filter upwards and out of the dishwasher.

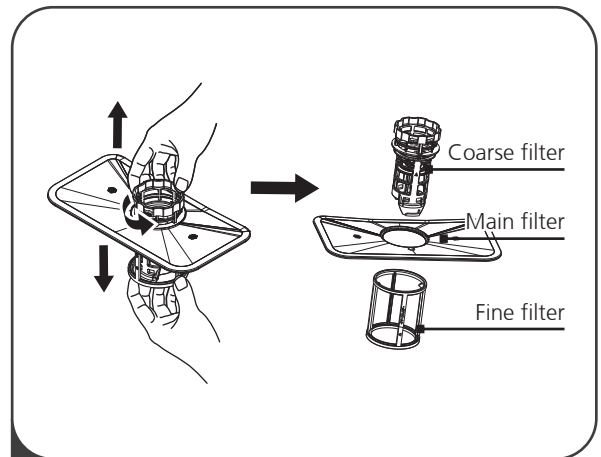

2 The fine filter can be pulled off the bottom of the filter assembly. The coarse filter can be detached from the main filter by gently squeezing the tabs at the top and pulling it away.

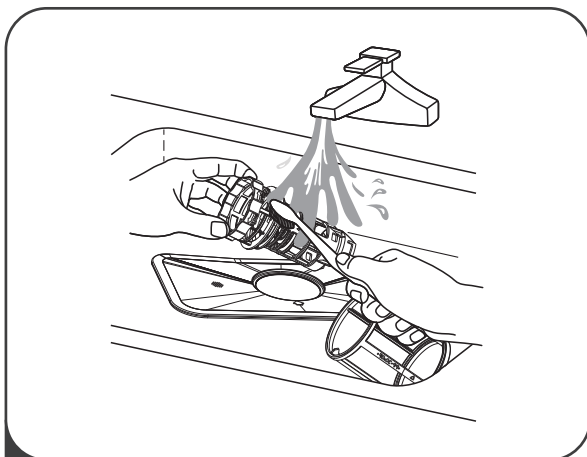

3 Larger food remnants can be cleaned by rinsing the filter under running water. For a more thorough clean, use a soft cleaning brush.

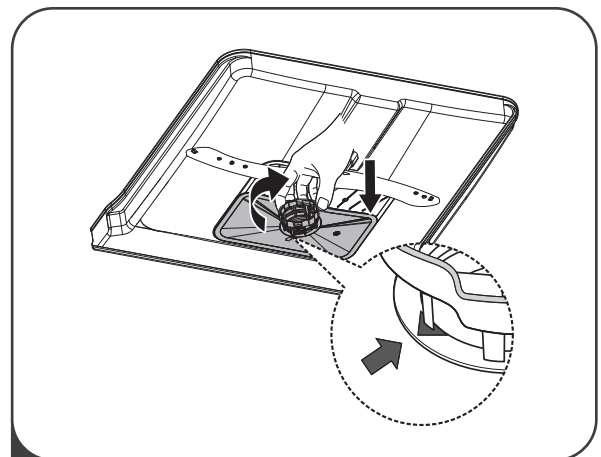

4 Reassemble the filters in the reverse order of the disassembly, replace the filter insert, and rotate clockwise to the close arrow.

⚠ WARNING

- Do not over tighten the filters. Put the filters back in sequence securely, otherwise coarse debris could get into the system and cause a blockage.
- NEVER use the dishwasher without filters in place. Improper replacement of the filter may reduce the performance level of the appliance and damage dishes and utensils.

Spray arms

It is necessary to clean the spray arms regularly for hard water chemicals will clog the spray arm jets and bearings.

To clean the spray arms, follow the instructions below:

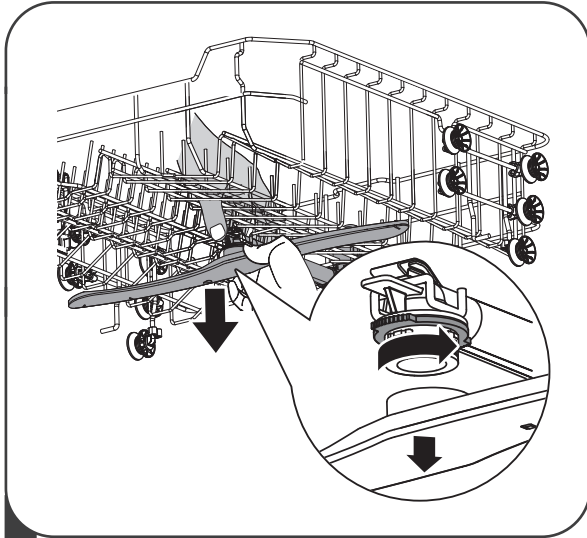

- 1** To remove the upper spray arm, hold the nut in the centre still and rotate the spray arm counterclockwise to remove it.

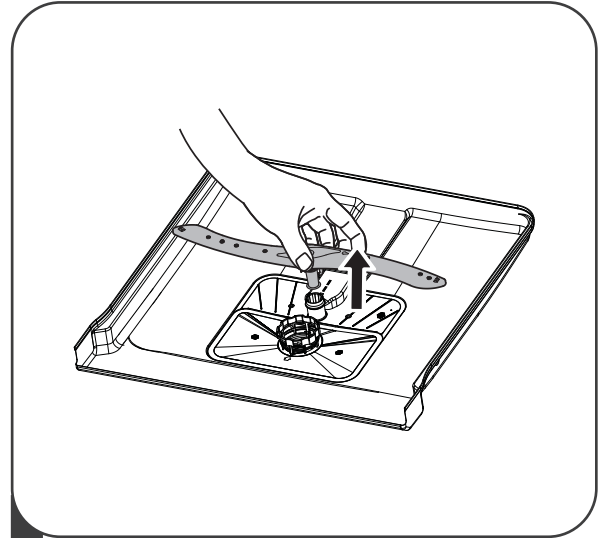

- 2** To remove the lower spray arm, pull out the spray arm upward.

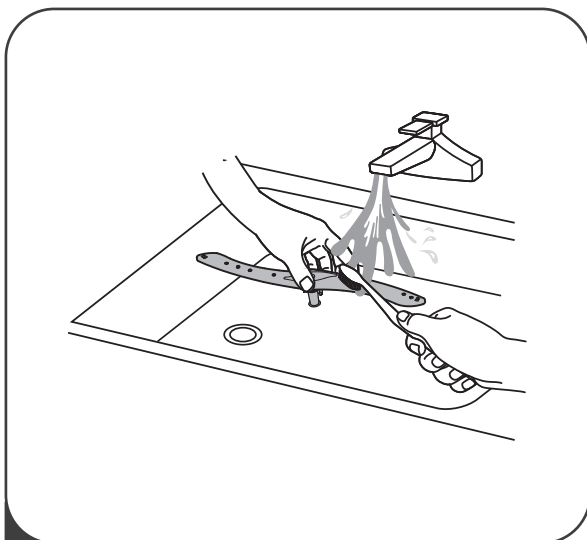

- 3** Wash the arms in soapy and warm water and use a soft brush to clean the jets. Replace them after rinsing them thoroughly.

Caring For The Dishwasher

Frost precaution

Please take frost protection precautions for the dishwasher in winter, especially if the ambient temperature is likely to be below 0°C. After every washing cycle, please operate as follows:

1. Cut off the electrical power to the dishwasher at the supply source.
2. Turn off the water supply and disconnect the water inlet pipe from the water valve.
3. Drain the water from the inlet pipe and water valve. (Use a pan to gather the water)
4. Reconnect the water inlet pipe to the water valve.
5. Remove the filter at the bottom of the tub and use a sponge to soak up water in the sump.

After every wash

After every wash, turn off the water supply to the appliance and leave the door slightly open so that moisture and odours are not trapped inside.

Remove the plug

Before cleaning or performing maintenance, always remove the plug from the socket.

No solvents or abrasive cleaning

To clean the exterior and rubber parts of the dishwasher, do not use solvents or abrasive cleaning products. Only use a cloth with warm soapy water.

To remove spots or stains from the surface of the interior, use a cloth dampened with water and a little vinegar, or a cleaning product made specifically for dishwashers.

When not in use for an extended period

It is recommended that you run a wash cycle with the dishwasher empty and then remove the plug from the socket, turn off the water supply and leave the door of the appliance slightly open. This will help the door seals to last longer and prevent odours from forming within the appliance.

Moving the appliance

If the appliance must be moved, try to keep it in the vertical position. If absolutely necessary, it can be positioned on its back.

05 INSTALLATION INSTRUCTION

NOTE: Before making preparations for or commencing installation, the installer should refer to the current online version of the User Manual, which is available on the Kleenmaid website (see back cover for details).

⚠ WARNING

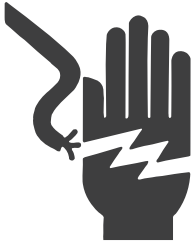

Electrical Shock Hazard

Disconnect electrical power before installing dishwasher.

Failure to do so could result in death or electrical shock.

⚠ Attention

The installation of the pipes and electrical equipment should be done by professionals.

⚠ WARNING: IT MUST BE ENSURED THAT THIS APPLIANCE IS CONNECTED ONLY TO A 230VAC +10%/-6% 50Hz MAINS POWER SUPPLY WHICH CONTINUOUSLY COMPLIES WITH THE RELEVANT AUSTRALIAN STANDARD. FAILURE TO DO SO MAY SERIOUSLY DAMAGE THE APPLIANCE AND ANY SUCH DAMAGE IS NOT COVERED BY THE MANUFACTURER'S WARRANTY. ⚠

About Power Connection

⚠ WARNING

For personal safety:

- Do not use an extension cord or an adapter plug with this appliance.
- Do not, under any circumstances, cut or remove the earthing connection from the power cord.

Electrical requirements

Please look at the rating label to know the rating voltage and connect the dishwasher to the appropriate power supply. Use the required fuse (10A/13A/16A), time delay fuse or circuit breaker recommended and provide a separate circuit.

Electrical connection

Ensure the voltage and frequency of the power supply corresponds to those on the rating plate. Only insert the plug into an electrical socket which is earthed properly. If the electrical socket to which the appliance must be connected is not appropriate for the plug, replace the socket, rather than using adaptors or the like as they could cause overheating and burns.

⚠ Before use ensure the appliance is correctly earthed.

Water Supply And Drain

Cold water connection

Connect the cold water supply hose to a threaded 3/4 (inch) connector and make sure that it is fastened tightly in place.

If the water pipes are new or have not been used for an extended period of time, let the water run to make sure that the water is clear. This precaution is needed to avoid the risk of the water inlet becoming blocked and damaging the appliance.



safety supply hose

About the safety supply hose

The safety supply hose has double walls. The hose's system guarantees its intervention to block the flow of water in case of the supply hose breaking and when the air space between the supply hose itself and the outer corrugated hose is full of water.

NOTE: Supply hose length is 1.97m.

⚠ WARNING

A hose that attaches to a sink spray can burst if it is installed on the same water line as the dishwasher. If your sink has one, it is recommended that the hose be disconnected and the hole plugged.

How to connect the safety supply hose

1. Pull the safety supply hose completely out from storage compartment located at rear of dishwasher.
2. Tightly screw the safety supply hose to a tap with 3/4 inch thread.
3. Turn water fully on before starting the dishwasher.

How to disconnect the safety supply hose

1. Turn off the water.
2. Unscrew the safety supply hose from the tap.

Connection Of Drain Hoses

Insert the drain hose into a drain pipe with a minimum diameter of 40mm, or let it run into the sink, making sure to avoid bending or crimping it. The height of the drain pipe must be less than 1000mm. The free end of the hose must not be immersed in water to avoid back flow.

NOTE: The drain hose length is 1.874m.

⚠ Please securely fix the drain hose in either position A or position B

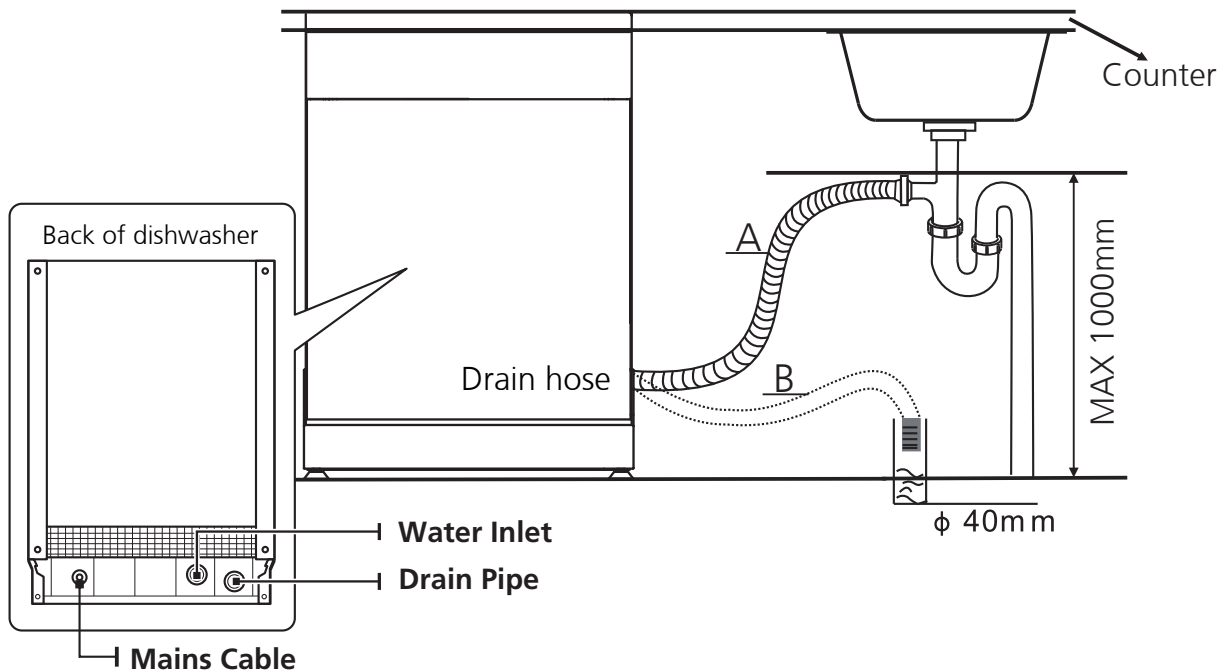

How to drain excess water from hoses

If the sink is higher than 1000mm from the floor, the excess water in hoses cannot be drained directly into the sink. It will be necessary to drain excess water from hoses into a bowl or suitable container that is held outside and lower than the sink.

Water outlet

Connect the water drain hose. The drain hose must be correctly fitted to avoid water leaks. Ensure that the water drain hose is not kinked or squashed.

Extension hose

If you need a drain hose extension, make sure to use a similar drain hose. It must be no longer than 4000mm; otherwise the cleaning effect of the dishwasher could be reduced.

Syphon connection

The waste connection must be at a height less than 1000mm (maximum) from the bottom of the dishwasher. The water drain hose should be fixed.

Position The Appliance

Position the appliance in the desired location. The back should rest against the wall behind it, and the sides, along the adjacent cabinets or walls. The dishwasher is equipped with water supply and drain hoses that can be positioned either to the right or the left sides to facilitate proper installation.

Levelling the appliance

Once the appliance is positioned for levelling, the height of the dishwasher may be altered by adjusting the level of the screw in feet.

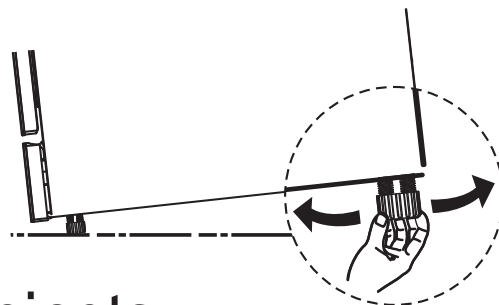

Fitting Between Existing Cabinets

The height of the dishwasher, 845 mm, has been designed in order to allow the machine to be fitted between existing cabinets of the same height in modern fitted kitchens. The feet can be adjusted so that the correct height is reached.

The laminated top of the machine does not require any particular care since it is heat, scratch and stain resistant.

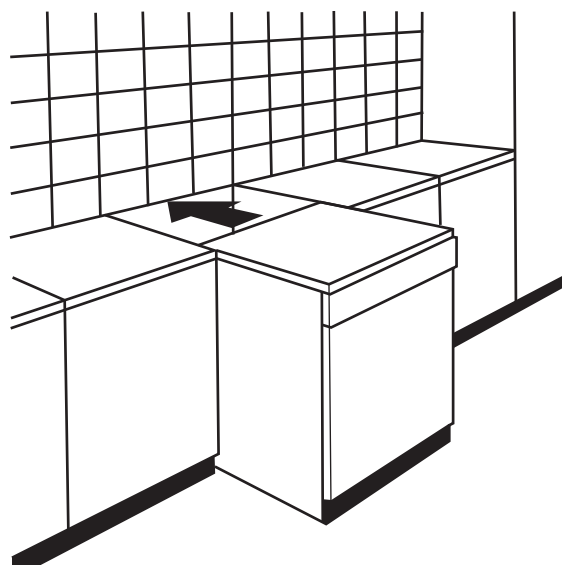

Fitting Under Existing Work Top

If the dishwasher is to be fitted under a permanent work top remove the top cover of the dishwasher by unscrewing the screws under the rear edge of the top (a). After removing the top cover, the screws MUST BE screwed in again under the rear edge of the top (b). The minimum height is reduced from 845 mm to 815 mm, and the dishwasher will fit under a standard height kitchen work top.

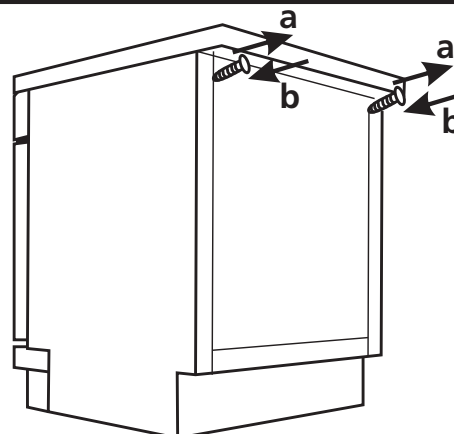

⚠ Attention

1. The height of the dishwasher under the benchtop may also be adjusted by screwing the adjustable feet in either direction.
2. The maximum adjustable leg extension height used for determining the maximum height of free-standing/built-under models is 25mm. See height range in the table below.

Worktop Installed		Worktop not installed	
Min Height	Max Height	Min Height	Max Height
845 mm	870 mm	815 mm	840 mm

3. If the dishwasher is installed at the corner of the cabinet, allow sufficient space for the door to open freely.

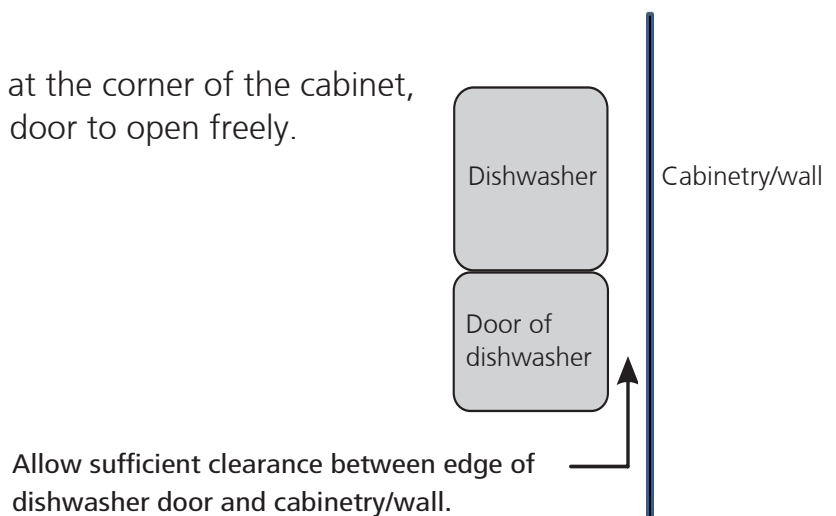

💡 NOTE:

Depending on where your electrical outlet is, you may need to cut a hole in the cabinet side.

Tension adjustment of the door spring

1. The door springs are set at the factory to the proper tension and should not need adjustment.
2. Door spring tension is correct when the door remains horizontal in the fully opened position, yet rises to a close with the slight lift of a finger.
3. If necessary adjust the tension of the door springs by using an Allen key, turning in a clockwise motion to tighten the left and right door springs.

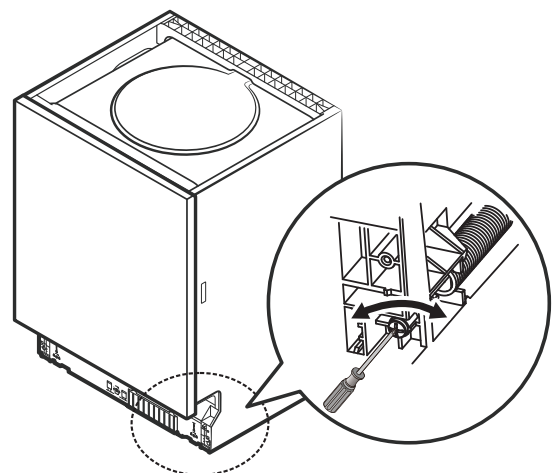

O6 TROUBLESHOOTING TIPS

Before Calling For Service

Reviewing the charts on the following pages may save you from calling for service.

Problem	Possible Causes	What To Do
Dishwasher doesn't start	Fuse blown, or the circuit breaker tripped.	Replace fuse or reset circuit breaker. Remove any other appliances sharing the same circuit with the dishwasher.
	Power supply is not turned on.	Make sure the dishwasher is turned on and the door is closed securely. Make sure the power cord is properly plugged into the wall socket.
	Water pressure is low	Check that the water supply is connected properly and the water is turned on.
	Door of dishwasher not properly closed.	Make sure to close the door properly and latch it.
Water not pumped from dishwasher	Twisted or trapped drain hose.	Check the drain hose.
	Filter clogged.	Check and clean the filter.
	Kitchen sink clogged.	Check the kitchen sink to make sure it is draining well. If the problem is the kitchen sink not draining well, you may need a plumber rather than a dishwasher service.
Suds in the tub	Wrong detergent.	Use only the special dishwasher detergent to avoid suds. If this occurs, open the dishwasher and let suds evaporate. Add 4.5 L of cold water to the bottom of the dishwasher. Close the dishwasher door, then select any cycle. Initially, the dishwasher will drain out the water. Open the door after draining stage is complete and check if the suds have disappeared. Repeat if necessary.

Problem	Possible Causes	What To Do
	Spilled rinse-aid.	Always wipe up rinse-aid spills immediately.
Stained tub interior	Detergent with colourant may have been used.	Make sure that the detergent has no colourant.
White film on inside surface	Hard water minerals	To clean the interior, use a damp sponge with dishwasher detergent and wear rubber gloves. Never use any other cleaner than dishwasher detergent, otherwise it may cause foaming or suds.
There are rust stains on cutlery	The affected items are not corrosion resistant.	The items should be corrosion resistant.
Knocking noise in the dishwasher	A spray arm is knocking against an item in a basket	Interrupt the programme and rearrange the items which are obstructing the spray arm.
Rattling noise in the dishwasher	Items of crockery are loose in the dishwasher.	Interrupt the programme and rearrange the items of crockery.
Knocking noise in the water pipes	This may be caused by on-site installation or the cross-section of the piping.	This has no influence on the dishwasher function. If in doubt, contact a qualified plumber.
The dishes are not clean	The dishes were not loaded correctly.	See notes in "Loading & unloading your dishwasher".
	The programme was not powerful enough.	Select a more intensive programme.

Problem	Possible Causes	What To Do
The dishes are not clean.	Not enough detergent was dispensed.	Use more detergent, or change your detergent.
	Items are blocking the movement of the spray arms.	Rearrange the items so that the spray arms can rotate freely.
	The filter combination is not clean or is not correctly fitted in the base of wash cabinet. This may cause the spray arm jets to get blocked.	Clean and/or fit the filter correctly. Clean the spray arm jets.
Cloudiness on glassware.	Combination of soft water and too much detergent.	Use less detergent if you have soft water and select a shorter cycle to wash the glassware and to get them clean.
Black or grey marks on dishes	Aluminium utensils have rubbed against dishes	Use a mild abrasive cleaner to eliminate those marks.
Detergent left in dispenser	Dishes block detergent dispenser	Re-loading the dishes properly.
The dishes are not drying	Improper loading	Load the dishwasher as suggested in the directions.
	Too little rinse-aid	Increase the amount of rinse-aid/refill the rinse-aid dispenser.
	Dishes are removed too soon	Do not empty your dishwasher immediately after washing. Open the door slightly so that the steam can come out. Do not take out the dishes until the inside temperature is safe to touch. Unload the lower basket first to prevent water dropping from the upper basket.

Problem	Possible Causes	What To Do
The dishes are not drying	Wrong program has been selected.	With a short program, the washing temperature is lower, decreasing cleaning performance. Choose a program with a longer washing time. You may also use the Extra Drying function with selected programs - see Part 2 page 4.
	Use of cutlery with a low-quality coating.	Water drainage is more difficult with these items. Cutlery or dishes of this type are not suitable for washing in the dishwasher.

07 LOADING THE BASKETS ACCORDING TO AS/NZS 2007.1:

1.Upper basket:

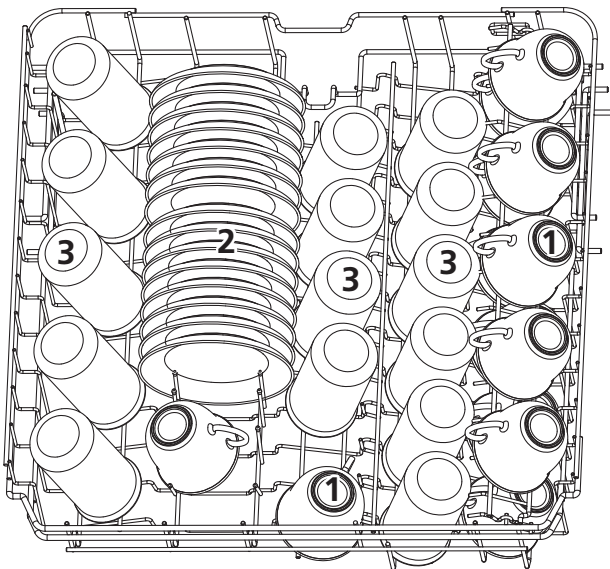

Number	Item
1	Cups
2	Saucers
3	Glasses

2.Lower basket:

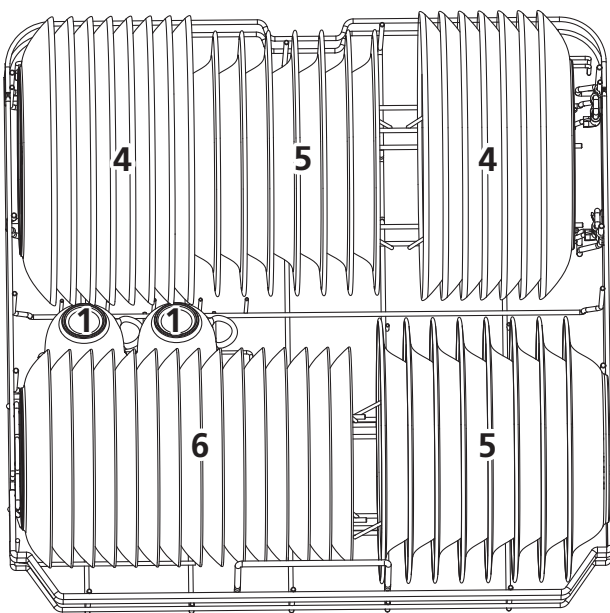

Number	Item
4	Dinner plates
5	Soup plates
6	Dessert dishes

3. Cutlery basket:

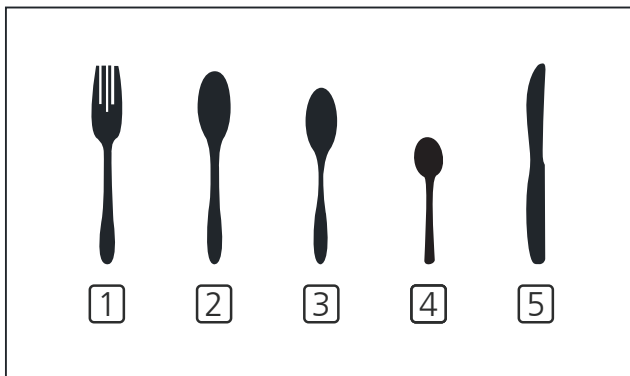
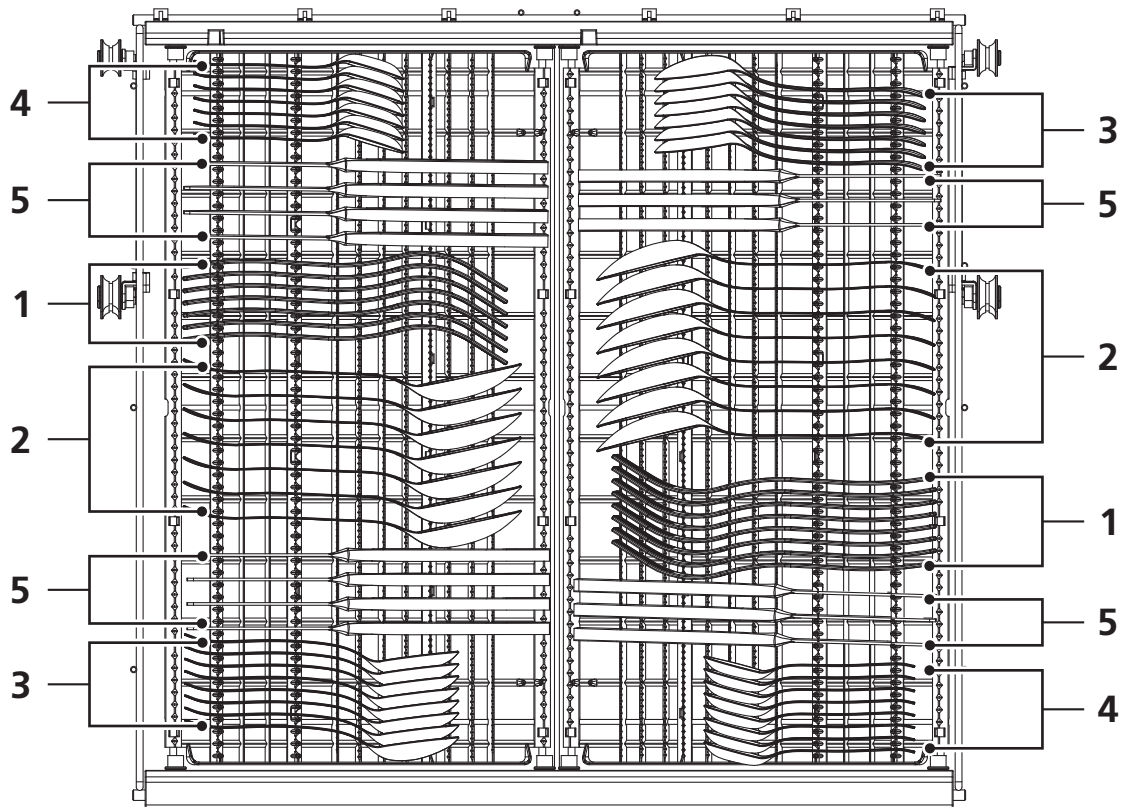

Number	Item
1	Forks
2	Soup spoons
3	Dessert spoons
4	Teaspoons
5	Knives

Information for comparability tests in accordance with (*AS/NZS 2007.1)

Capacity: 15 place settings

Position of the upper basket: lower position

Program: ECO

Rinse aid setting: 6

Detergent(Pre/main): 5g/28.75g

Door is open at the end of the drying cycle for the drying performance test

(Door position: Open 50 mm)

|| PART 2 Detailed Operating Instructions



01	2	USING YOUR DISHWASHER
	2	Control Panel
	5	Preparing And Loading Dishes
	8	Function Of The Rinse Aid And Detergent
	9	Filling The Rinse Aid Reservoir
02	10	Filling The Detergent Dispenser
	11	PROGRAMMING THE DISHWASHER
	11	Wash Cycle Table
	12	Starting A Cycle Wash
03	12	Changing The Program Mid-cycle
	13	Forget To Add A Dish?
04	14	ERROR CODES
	15	TECHNICAL INFORMATION

01 USING YOUR DISHWASHER

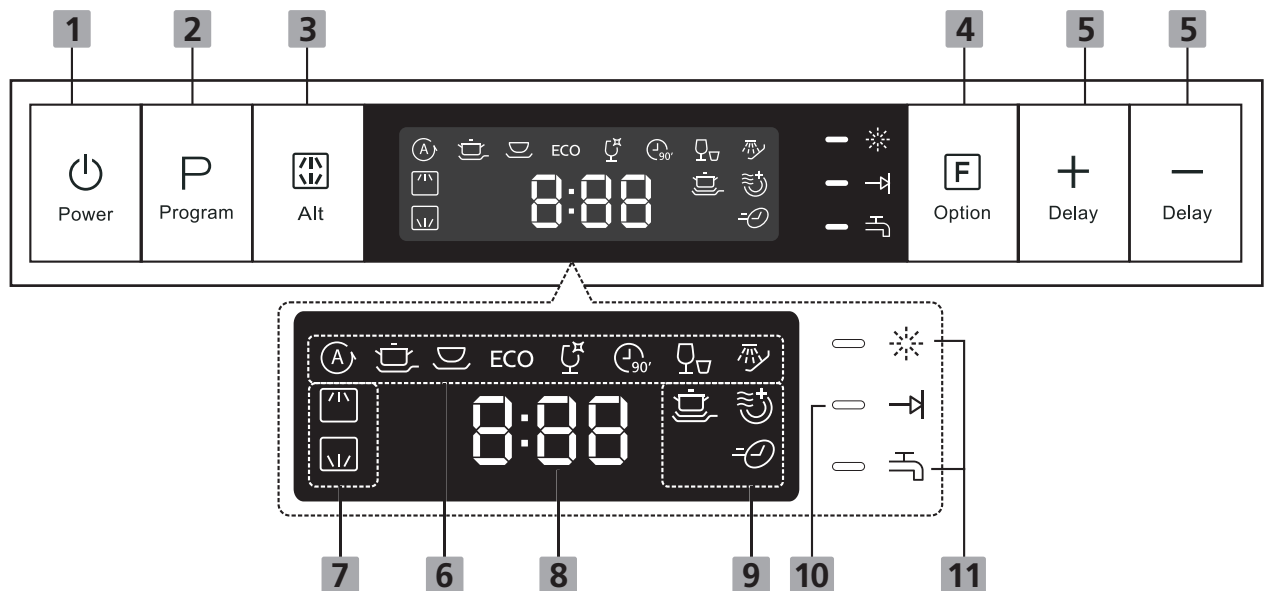









Control Panel









Operation (Button)

1 Power	Press this button to turn on your dishwasher.
2 Program	Select the appropriate washing program and the selected program indicator will light up.
3 Alt	Dual zone wash function: press the button to select either upper basket or lower basket loaded, and the response indicator ( ) will light up.
4 Option	Press the button to select a function, and the corresponding indicator will light up.
5 Delay +/-	Press the " + " button to add the delay time or press the " - " button to decrease the delay time. Maximum time that can be set for delay is 24 hours

Display

<p>6 Program indicator</p>	<p> Auto Auto sensing wash, lightly, or heavily soiled crockery, with or without dried-on food.</p> <p> Intensive For heaviest soiled crockery, such as pots, pans, casserole dishes and dishes that have been sitting with dried food on them for a while.</p> <p> Heavy For heavily soiled loads, such as pots, plates, glasses and lightly soiled pans.</p> <p>ECO ECO For normally soiled loads, such as pots, plates, glasses and lightly soiled pans, standard daily cycle.</p> <p> Glass For lightly soiled crockery and glass.</p> <p> 90 min For lightly soiled loads and pans that need a quick wash.</p> <p> Rapid A shorter wash for lightly soiled loads that do not need drying.</p> <p> Soak To rinse dishes that you plan to wash later that day.</p>
<p>7 Alt indication</p>	<p> Upper When you select Upper, only the upper rack nozzle is activated. The lower nozzle will not operate.</p> <p> Lower When you select Lower, only the lower rack nozzle is activated. The upper nozzle will not operate.</p>
<p>8 Screen</p>	<p> Shows the remaining time and delay time, error codes etc.</p>

Display

9 Function indication	 Extra wash To wash very dirty, hard to clean dishes. (It can only be used with Intensive, Heavy, ECO, Glass, 90Min)  Extra drying To dry dishes more completely. (It can only be used with Intensive, Heavy, ECO, Glass, 90Min)  Express Reduce the program time.
10 Progress indicator	 Program end When the program ends the indicator will light up.
11 Warning indicator	 Rinse Aid If the " ☀ " indicator is lit, it means the dishwasher is low on dishwasher rinse aid and requires a refill.  Water Tap If the " 🚰 " indicator is lit, it means the water tap is turned off.

• Preparing And Loading Dishes

- Consider buying utensils which are identified as dishwasher-proof.
- For particular items, select a program with the lowest possible temperature.
- To prevent damage, do not take glass and cutlery out of the dishwasher immediately after the program has ended.

For washing the following cutlery/dishes dishwashers

Are not suitable:

- Cutlery with wooden, horn, china or mother-of-pearl handles
- Plastic items that are not heat resistant
- Older cutlery with glued parts which are not temperature resistant
- Bonded cutlery items or dishes
- Pewter or copper items
- Crystal glass
- Steel items subject to rusting
- Wooden platters
- Items made from synthetic fibres

Are of limited suitability:

- Some types of glasses can become dull after a large number of washes
- Silver and aluminum parts have a tendency to discolour during washing
- Glazed patterns may fade if machine washed frequently

Recommendations for loading the dishwasher

Scrape off any large amounts of leftover food. Soften remnants of burnt food in pans. It is not necessary to rinse the dishes under running water.

To obtain the best performance from the dishwasher, follow these loading guidelines.

Place objects in the dishwasher in the following way:

- Items such as cups, glasses, pots/pans, etc. are faced downwards.
- Curved items, or ones with recesses, should be loaded aslant so that water can run off.
- All utensils are stacked securely and cannot tip over.
- All utensils are placed so that the spray arms can rotate freely during washing. Check before starting dishwasher.
- Load hollow items such as cups, glasses, pans etc with the opening facing downwards so that water cannot collect in the container or a deep base.
- Dishes and items of cutlery must not lie inside one another, or cover each other. To avoid damage, glasses should not touch one another.
- The upper basket is designed to hold more delicate and lighter dishware such as glasses, coffee and tea cups.
- Long bladed knives loaded in an upright position are a potential hazard!
- Long and / or sharp items of cutlery such as carving knives must be positioned horizontally in the upper basket.
- Please do not overload your dishwasher. This is important for good results and for reasonable consumption of energy.

NOTE:

Very small or light items should not be washed in the dishwasher as they could easily fall out of the basket.

Removing the dishes

To prevent water dripping from the upper basket into the lower basket, we recommend that you empty the lower basket first, followed by the upper basket.

WARNING



Items will be hot! To prevent damage, do not take glass and cutlery out of the dishwasher until 15 minutes after the program has ended.

Loading the upper basket

The upper basket is designed to hold more delicate and lighter dishware such as glasses, coffee and tea cups and saucers, as well as plates, small bowls and shallow pans (as long as they are not too dirty). Position the dishes and cookware so that they will not be moved by the spray of water.

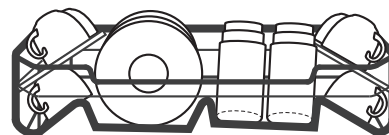

Loading the lower basket

We suggest that large items and the most difficult to clean items be placed into the lower basket: such as pots, pans, lids, serving dishes and bowls, as shown in the figure below. It is preferable to place serving dishes and lids on the side of the racks in order to avoid blocking the rotation of the top spray arm. The maximum diameter advised for plates placed in front of the detergent dispenser is 19 cm, so as not to hamper its opening.

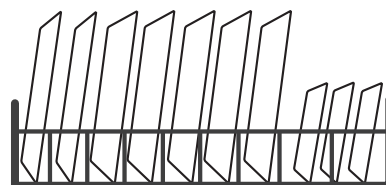

Loading the cutlery basket

Cutlery items should be placed in the cutlery rack separately from each other in the appropriate positions. Make sure the utensils do not nest together as this may affect optimum performance. For flexibility in loading the dishwasher the third level cutlery tray has five available shelving configurations. This includes the ability to slide one half of the tray on top of the other half to accommodate taller items placed in the basket below. The diagrams on the tray front indicate the various options.

⚠ WARNING



Do not let any item extend through the bottom.
Always load sharp utensils with the sharp point down!



Please refer to Part 1 Section 07 for further information on loading the baskets.

Function Of The Rinse Aid And Detergent

The rinse aid is released during the final rinse to prevent water from forming droplets on your dishes, which can leave spots and streaks. It also improves drying by allowing water to roll off the dishes. Your dishwasher is designed to use liquid rinse aids.

⚠ WARNING

Only use branded rinse aid for dishwasher. Never fill the rinse aid dispenser with any other substances (e.g. Dishwasher cleaning agent, liquid detergent). This would damage the appliance.

When to refill the rinse aid dispenser

Unless the rinse-aid warning light () on the control panel is on, you can always estimate the amount from the color of the optical level indicator located next to the cap. When the rinse-aid container is full, the indicator will be fully dark. The size of the dark dot decreases as the rinse-aid diminishes. You should never let the rinse aid level be less than 1/4 full.

As the rinse aid level diminishes, the size of the black dot on the rinse aid level indicator changes, as illustrated below.

● Full ● 3/4 full ● 1/2 full ● 1/4 full ○ Empty

Function of detergent

The chemical ingredients that compose the detergent are necessary to remove, crush and dispense all dirt out of the dishwasher. Most commercially available quality dishwasher detergents are suitable for this purpose.

⚠ WARNING

• Proper Use of Detergent

Use only detergent specifically made for dishwashers use. Keep your detergent fresh and dry.

Don't put powdered detergent into the dispenser until you are ready to wash dishes.



Dishwasher detergent is corrosive! Keep dishwasher detergent out of the reach of children.

Filling The Rinse Aid Reservoir

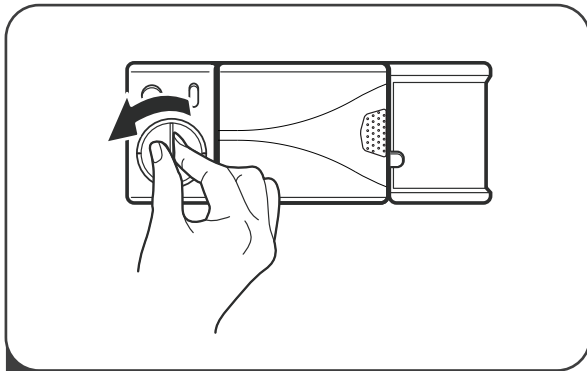

1 Remove the rinse aid reservoir cap by rotating it counterclockwise.

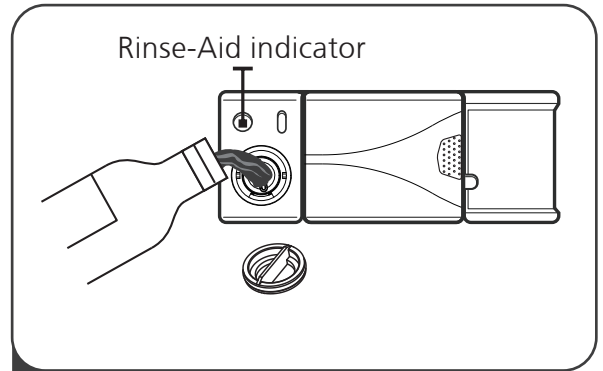

2 Pour the rinse aid into the dispenser, being careful not to overfill.

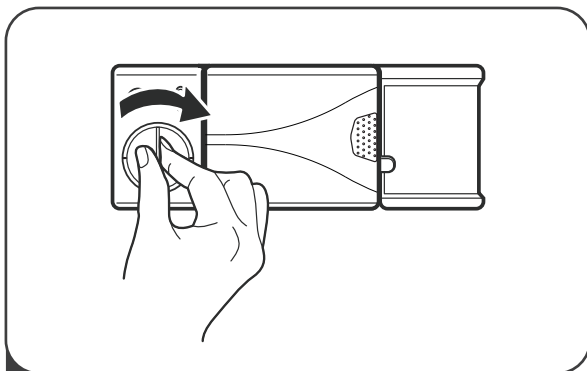

3 Close the rinse aid reservoir cap by rotating it clockwise.

NOTE:

Clean up any spilled rinse aid with an absorbent cloth to avoid excessive foaming during the next wash.

Adjusting the rinse aid reservoir

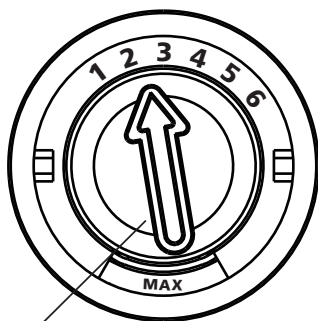

The rinse aid reservoir has six settings. The recommended setting, set by the factory, is "3". If the dishes are not drying properly or are spotted, adjust the dial to the next highest number until your dishes are spot-free. Reduce it if there are sticky, whitish stains on your dishes or a bluish film on glassware or knife blades.

Filling The Detergent Dispenser

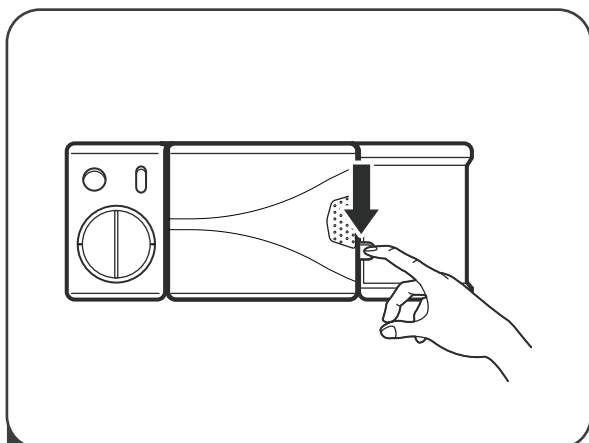

- 1 Open the detergent dispenser flap by pushing the detergent dispenser release catch.

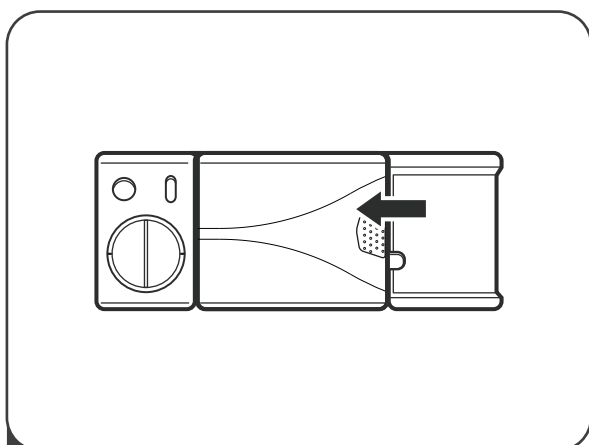

- 3 Close the flap by sliding it to the left and then pressing it down.

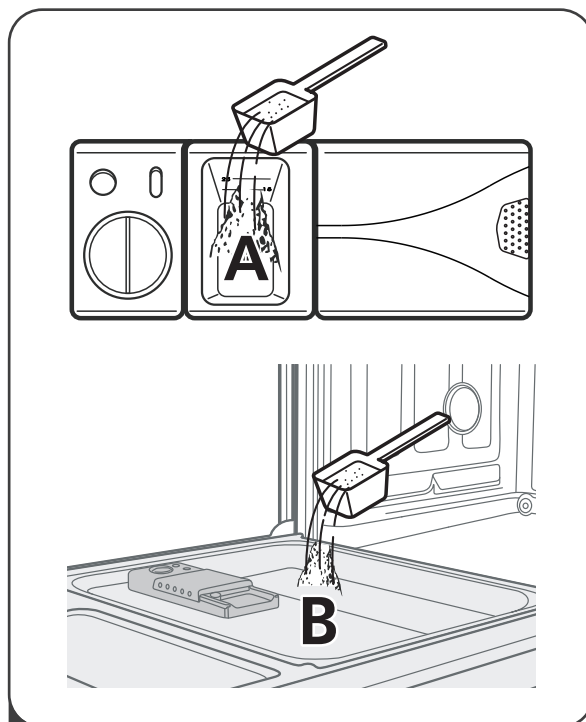

- 2 Add detergent into the larger cavity (A) for the main wash cycle . For better cleaning result, especially if you have very dirty items, pour a small amount of detergent onto the door (B). The additional detergent will activate during the pre-wash phase.

NOTE:





- Please be aware that the amount of detergent required may vary according to the level of soiling and the specific hardness of the water.
- Please observe the manufacturer's recommendations on the detergent packaging.



02 PROGRAMMING THE DISHWASHER

Wash Cycle Table

The table below shows which programs are best for the levels of food residue on dishes and how much detergent is needed. It also show information about the programs.

(●) Means: need to fill the Rinse-Aid Dispenser.

Program	Description Of Cycle	Detergent Pre/Main	Running Time(min)	Energy (Kwh)	Water (L)	Rinse Aid
 Auto	Pre-wash(45°C) Autowash (45-55°C) Rinse Rinse(65°C) Drying	$\frac{5}{28.75g}$ (1 piece)	150	0.9 ~1.3	11~15	●
 Intensive	Pre-wash(50°C) Wash(60°C) Rinse Rinse Rinse(70°C) Drying	$\frac{5}{28.75g}$ (1 piece)	175	1.5	19	●
 Heavy	Pre-wash(45°C) Wash(55°C) Rinse Rinse(65°C) Drying	$\frac{5}{28.75g}$ (1 piece)	185	1.1	15	●
ECO (*AS/NZS 2007.1)	Pre-wash Wash(45°C) Rinse(45°C) Drying	$\frac{5}{28.75g}$ (1 piece)	195	0.641	11.8	●
 Glass	Pre-wash Wash(40°C) Rinse Rinse(60°C) Drying	$\frac{5}{28.75g}$ (1 piece)	130	0.75	15	●
 90 Min	Wash(65°C) Rinse Rinse(65°C) Drying	$\frac{33.75g}{(1\ piece)}$	90	1.15	13	●

Program	Description Of Cycle	Detergent Pre/Main	Running Time(min)	Energy (Kwh)	Water (L)	Rinse Aid
 Rapid	Wash(45°C) Rinse(55°C) Rinse(55°C)	20g	30	0.7	12.5	○
 Soak	Prewash		15	0.02	4.5	○

NOTE:

AS/NZS 2007.1: This program is the test cycle. The parameters for the comparability test are in accordance with *AS/NZS 2007.1.

Starting A Wash Cycle

1. Draw out the lower and upper basket, load the dishes and push them back. It is recommended to load the lower basket first, then the upper one.
2. Pour in the detergent.
3. Insert the plug into the socket. For power supply information refer to "Product data" on the last page. Make sure that the water supply is turned on to full pressure.
4. Open the door, press the Power button.
5. Choose a program then the response light will turn on. When the door is closed the dishwasher will start its cycle.

Changing The Program Mid-cycle

A wash cycle should only be changed if it has been running for a short time, otherwise the detergent may have already been released and the dishwasher may have already drained the wash water. If this is the case, the dishwasher needs to be reset and the detergent dispenser must be refilled. To reset the dishwasher, follow the instructions below:

1. Open the door a little to stop the dishwasher, then after the spray arm stops working you can open the door completely.
2. Press Program button for more than three seconds so the machine will be in stand by state.
3. You can change the program to the desired cycle setting.

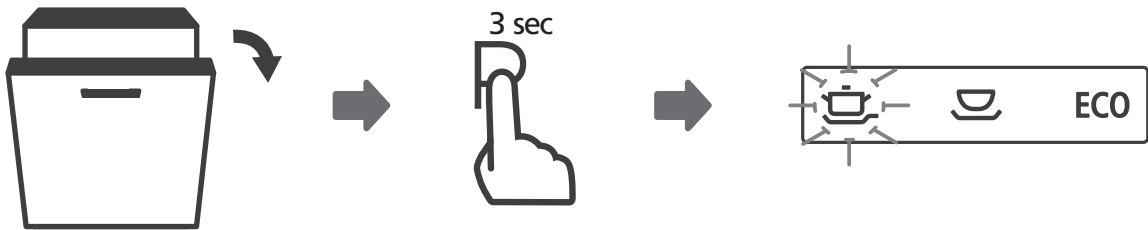

Forget To Add A Dish?

A forgotten dish can be added any time before the detergent dispenser opens. If this is the case, follow the instructions below:

1. Open the door a little to stop the washing.
2. After the spray arms stop working, you can open the door completely.
3. Add the forgotten dishes.
4. Close the door.
5. The dishwasher will start running again.

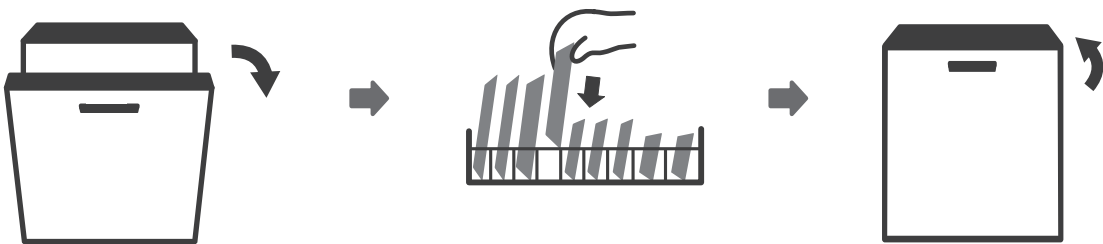

⚠ WARNING



It is dangerous to open the door mid-cycle, as hot steam may scald you.

03 ERROR CODES

If there is a malfunction, the dishwasher will display error codes. To identify these:

Codes	Meanings	Possible Causes
E1	Longer inlet time.	Tap is not opened, or water intake is restricted, or water pressure is too low.
E3	Not reaching required temperature.	Malfunction of heating element.
E4	Overflow.	Some element of dishwasher leaks.
E8	Failure of orientation of distributary valve.	Open circuit or break of distributary valve.
E9	Keep pressing a button more than 30 seconds.	Water or something on the button.
Ec	Washing control system fail.	PCB or motor fail.

⚠ WARNING

- If overflow occurs, turn off the main water supply before calling for a service.
- If there is water in the base pan because of an overflow or small leak, the water should be removed before restarting the dishwasher.

04 TECHNICAL INFORMATION

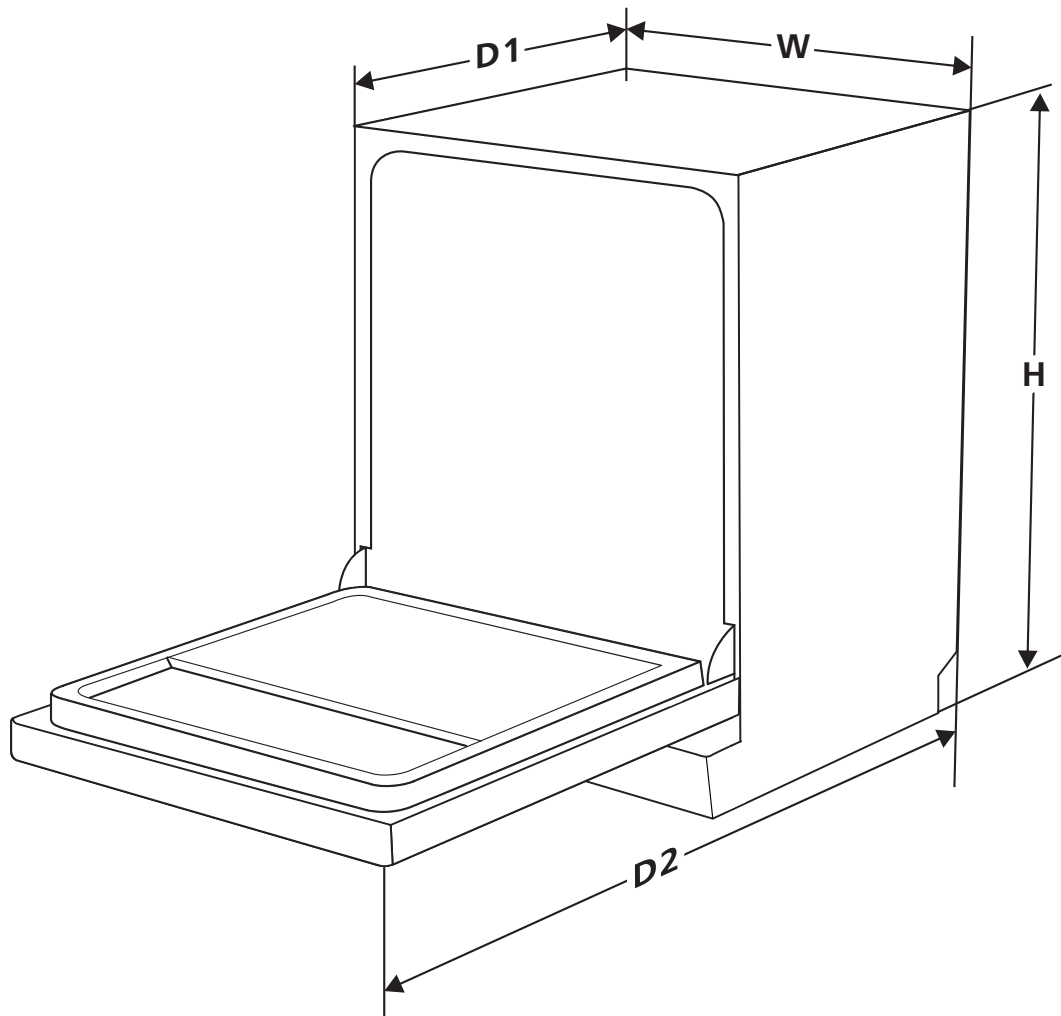

Height (H)	845mm
Width (W)	598mm
Depth (D1)	600mm (with the door closed)
Depth (D2)	1175mm (with the door opened 90°)

Product data

Manufacturer	Kleenmaid	
Type / Description	DW6030	
Standard place settings	15	
Energy efficiency class	★ ★ ★ ★ ☆ ☆	4
Water consumption class	★ ★ ★ ★ ☆	5
Standard cleaning cycle	ECO	
Energy consumption of the standard cleaning cycle	0.641 kWh	
Water consumption of the standard cleaning cycle	11.8 litres	
Program duration of the standard cleaning cycle	195 min	
Noise level	45 dB(A) re 1 pW	
Mounting	Free-standing	
Can be built-under?	YES	
Power consumption	1700-2000W	
Rated voltage / frequency	AC 220-240V/50Hz	
Water pressure (flow pressure)	0.04-1.0MPa=0.4-10 bar	

This page intentionally left blank

KLEENMAID WARRANTY

TERMS AND CONDITIONS

1. Compass Capital Services Pty Ltd ABN 96 138 214 525 trading as Kleenmaid will provide parts and labour to you the customer as set out herein.
2. Kleenmaid may engage a Service Agent to provide service under this warranty.
3. Kleenmaid's Products come with guarantees that cannot be excluded under the Australian Consumer Law. You are entitled to a replacement or refund for a major failure and for compensation for any other reasonably foreseeable loss or damage. You are also entitled to have the goods repaired or replaced if the goods fail to be of acceptable quality and the failure does not amount to a major failure.
4. The benefits given to you under this Kleenmaid Warranty are in addition to other rights and remedies to which you may be entitled under the Australian Consumer Law in relation to the Product to which this Kleenmaid Warranty relates. Subject to the conditions below, the Product is warranted by Kleenmaid and/or its agents to be free from defects in materials and workmanship for the Warranty Period for normal Domestic Use.
5. Product Identification: -
 - a. Kleenmaid reserves the right to reject claims for any services or work where you cannot produce for verification the serial number and a proof of purchase for the Product (including but not limited to the original invoice).
 - b. this Kleenmaid Warranty will be voided if the serial number for the Product cannot be verified. This is not intended to exclude, restrict or modify any right or remedy to which you may otherwise be entitled under the consumer guarantee provisions of the Australian Consumer Law.
 - c. in the event that a request for repair is made against this Kleenmaid Warranty where the serial number for the Product cannot be verified or you cannot produce for verification a proof of purchase for the Product (including but not limited to the original invoice), the repairer will not carry out any repairs on the Product and you will be charged a service call-out fee.
6. What is covered by this Kleenmaid Warranty: -
 - a. the Product is covered for faulty workmanship or parts that have failed under normal Domestic Use.
 - b. Kleenmaid and/or its agents will determine by objective testing if there are any defects in the Product and/or faulty workmanship.
 - c. this Kleenmaid Warranty is only applicable if repairs on Products are carried out within Mainland Australia.
 - d. this Kleenmaid Warranty: -
 - i. covers a Product purchased as new, manufactured for use in Mainland Australia;
 - ii. commences from the date of delivery of the Product;
 - iii. provides for the labour and replacement parts necessary to maintain the Product in good operating condition as specified in this Kleenmaid Warranty, however, if repair is needed because of Product failure during normal Domestic Use, Kleenmaid has the option to repair or replace the defective Product or part of the Product with a product or part of like kind and quality. A replacement part may be new or reconditioned of like kind and quality and may cost less than the original Product purchased and no charges or refunds will be made based on the replacement product or part cost difference; and
 - iv. is only applicable when the Product is used and operated in accordance with the Manufacturer's instructions.
7. What is not Covered by this Kleenmaid Warranty (excluded):-
 - a. any damage or failure to or of the Product or part of the Product:
 - i. due to the Product being inadequately serviced to manufacturer's recommendations;
 - ii. resulting from environmental conditions including and not limited to dirt, dust, rodents, insects, rust, corrosion, salt built-up, or of in any part of the Product;
 - iii. resulting from excessive use but fair wear and tear is excepted;
 - iv. resulting from installation by an unqualified or uncertified tradesperson;
 - v. resulting from poor or incorrect installation including and not limited to positioning and externally fitted equipment such as plumbing and drainage, cabling, antennae or due to incompatibility of connected equipment;
 - vi. caused by overheating as a result of sitting or positioning of the Product, where there is no provision for adequate ventilation or adequate protection from excessive dust;
 - vii. if the Product has been dismantled, repaired or serviced by any person other than someone authorised by Kleenmaid or its agents or representatives;
 - viii. caused by power surges or spikes, including and not limited to, mains power and telecommunications connections, or to other unspecified sources, incorrect power current, voltage fluctuation, amperage fluctuation, rust or corrosion;
 - ix. if the Product is dropped, collision of the Product with another object, use for which the Product is not designed, damage to the Product caused by your own negligence, accidental or deliberate misuse of the Product by you, theft, abuse, vandalism, flood, fire, earthquake, electrical storms or any other act of God or any war related events; or
 - x. due to the introduction of abnormal heat loads to the Product;
 - b. costs of attendance and testing where no fault or defect covered by the terms of this Kleenmaid Warranty is identified in the Product;
 - c. initial setup and installation of the Product;
 - d. normal maintenance costs and costs incurred through the installation of items listed as requiring periodic replacement;
 - e. Products with removed or altered serial numbers;
 - f. broken or cracked glass other than transport damage to the initial point of delivery;
 - g. consumables such as but not limited to bulbs/globes, seals, filters, batteries and remote controls;
 - h. removal and reinstallation of an internal component not performed by an authorised Kleenmaid agent or representative or authorised service centre;
 - i. cosmetic or structural items; or
 - j. any failures due to interference from or with other products and/or sources.
8. This Kleenmaid Warranty ceases if: -
 - a. the Product ceases to carry the original manufacturer's serial number or is sold at an auction;
 - b. the Product is rented; or
 - c. there is failure to pay monies owing on invoices as a result of non-warranty work being carried out at the request of the end user as per point 16 below.

9. Service under this warranty may be limited by the area in which you live. Service to remote and regional areas may incur additional travel costs which will be payable by you. You will be advised of this at the time you make a claim and Kleenmaid arranges to attend your premises.
10. Neither Kleenmaid nor its representatives provide loan equipment under the terms of this Kleenmaid Warranty.
11. Any unauthorised access to the internal hardware of the Product will void this Kleenmaid Warranty.
12. Repair Notice: Products presented for repair may be replaced by refurbished Products of the same type rather than being repaired. Refurbished parts may be used to repair the Products.
13. Replacement items are "like for like" and is not "new for old" and does not indicate in any way that a faulty Product will be replaced with a new part or unit. "Like for like" may either be a quality checked, refurbished or reconditioned unit of the same or later batch of model/size/specifications
14. The cost of making a claim under this Kleenmaid Warranty is not covered by Kleenmaid, including any costs of transportation or travel expenses between your home and your nearest authorised service agent.
15. Kleenmaid accepts no liability for items that are lost, damaged, or stolen as a result of freight, transport or storage. If you are required to transport the Product to an authorised service centre, you must ensure that it is securely packed and insured.
16. On Public Holidays or other periods when regular business and wholesale operations are temporarily ceased, repairer availability and warranty response times may extend beyond the standard response times due to the unavailability of repairers and parts.
17. For any repair performed on a Product under this Kleenmaid Warranty where no fault can be found, or the item is deemed by Kleenmaid or an authorised agent, to be not faulty under this Kleenmaid Warranty, or the repair or fault is not covered under this Kleenmaid Warranty, a 'No Fault Found' fee is payable by you. Kleenmaid will advise you of this cost and seek your agreement to pay such costs before commencing such repairs.
18. Any repairs or services required that are outside the terms and conditions of this Kleenmaid Warranty can be carried out at your request at your cost (including where the Product has not been installed or set up correctly). Kleenmaid will always advise you of this cost and seek your agreement to pay such costs before commencing such repairs. A credit card may be required prior to the commencement of such services.
19. Extra charges will be payable by the customer should the Product not be readily accessible without special equipment, such as but not limited to cranes and lifts or should the Product be installed in a position that service access is blocked and/or repair work is not possible without uninstalling the Product to gain access.
20. You, the customer, may be entitled to purchase an extended warranty in respect of the Product. Any extended warranty will not be issued by Kleenmaid but by a third party. Any extended warranty services will be provided directly by the third party as principal and not as agent for Kleenmaid, under their extended warranty terms and conditions and not under this Kleenmaid Warranty.
21. To make a claim under this Kleenmaid Warranty, please have your proof of purchase and the serial number of the Product ready and call (02) 9310 1207 during business hours.
22. This Kleenmaid Warranty is given by:
 Name: Compass Capital Services Pty Ltd ABN 96 138 214 525 trading as Kleenmaid
 Business address: Level 2, Suite 3, 204 Botany Rd, Alexandria NSW Australia 2015
 Telephone: (02) 9310 1207
23. Definitions:
 - a. **Australian Consumer Law** means the *Competition and Consumer Act 2010* (Cth).
 - b. **Domestic Use** means use of the Product for personal, domestic or household purposes.
 - c. **Kleenmaid** means Compass Capital Services Pty Ltd ABN 96 138 214 525 trading as Kleenmaid.
 - d. **Mainland Australia** means the following States and Territories of Australia: New South Wales, Victoria, South Australia, Western Australia, Queensland, Tasmania, Northern Territory, Australian Capital Territory.
 - e. **Product** means the appliance sold by Kleenmaid to you as evidenced by the original purchase invoice.
 - f. **Service Agent** means any independent service agent engaged by Kleenmaid to carry out any repair or service under this warranty.
 - g. **Warranty Period** means for domestic use and for Products purchased on or after 1 January 2019 the period of 60 months, otherwise 36 months. For non-domestic use 12 months or such alternative period as may be specified.

UPDATE NOTICE: This Kleenmaid Warranty is current as at 1 December 2022 but is subject to variation from time to time. For the latest version of the Kleenmaid Warranty, please see our website <https://kleenmaid.com.au/warranty/> or phone us on (02) 9310 1207.

Other products available in the Kleenmaid range of appliances

- | Washing machines
- | Clothes dryers
- | Dishwashers
- | Ovens
- | Cooktops
- | Steam ovens
- | Microwave ovens
- | Built in espresso coffee machines
- | Rangehoods
- | Freestanding ovens
- | Refrigerators & Freezers
- | Beverage Serving Cabinets
- | Water Dispensers
- | Vacuum Cleaners

To register your warranty or make a warranty claim, scan this QR code:



Compass Capital Services Pty Limited
trading as Kleenmaid
ABN 96138214525

Level 2, 204 Botany Road Alexandria
NSW 2015



Register your Kleenmaid
Appliances Warranty
www.kleenmaidwarranty.com.au



Request a Warranty Service
www.kleenmaidwarranty.com.au

E: warranty@kleenmaid.com.au

Please download the current User Manual for this
appliance at www.kleenmaid.com.au

 **kleenmaid**