

CSP9GMXA-1

Cooker size	90x60 cm
Hob type	Gas
Type of main oven	Thermoseal
Cleaning system main oven	Pyrolitic
EAN code	8017709308421



Aesthetics













Serie	Sinfonia	Display	Touch
Aesthetic	Classic	No. of controls	8
Colour	Stainless steel	Serigraphy colour	Black
Finishing	Satin	Handle	Smeg Classic
Design	Square design	Handle Colour	Brushed stainless steel
Door	With 2 horizontal strips	Glass type	eclipse
Upstand	Yes	Feet	Silver
Type of pan stands	Cast Iron	Plinth	Stainless steel
Hob colour	Stainless steel	Storage compartment	Door
Command panel finish	Finger friendly stainless steel	Logo	Assembled st/steel
Control knobs	Smeg Classic	Logo position	Facia below the oven
Controls colour	Stainless steel		

Programs / Functions

No. of cooking functions	9
--------------------------	---

Traditional cooking functions

 Static	 Fan assisted	 Circulaire
 Turbo	 Eco	 Small grill
 Large grill	 Fan grill (large)	 Fan assisted bottom
 Rotisserie		







Cleaning functions

 Pyrolytic
--

Hob technical features

 UR			
Total no. of cook zones	6		
Front left - Gas - 2UR (dual)	- 5.10 kW		
Rear centre - Gas - Semi Rapid	- 1.80 kW		
Front centre - Gas - AUX	- 1.00 kW		
Rear right - Gas - Rapid	- 3.00 kW		
Front right - Gas - Semi Rapid	- 1.80 kW		
Rear right - Gas - Rapid	- 3.00 kW		
Type of gas burners	Standard	Gas safety valves	Yes
Automatic electronic ignition	Yes	Burner caps	Matt black enamelled

Main Oven Technical Features

						
No. of lights	2	Total no. of door glasses	4			
Fan number	2	No. of thermo-reflective door glasses	2			
Cavity material	Ever Clean enamel	Safety Thermostat	Yes			
No. of shelves	5	Cooling system	Tangential			
Type of shelves	Metal racks	Usable cavity space dimensions (HxWxD)	371x724x418 mm			
Light type	Halogen	Temperature control	Electro-mechanical			
Light Power	40 W	Lower heating element power	1700 W			
Cooking time setting	Start and Stop	Upper heating element - Power	1200 W			
Light when oven door is open	Yes	Grill element	1700 W			
Door opening	Flap down	Large grill - Power	2900 W			
Removable door	Yes	Circular heating element - Power	2000 W			
Full glass inner door	Yes	Grill type	Electric			
Removable inner door	Yes					

Options Main Oven

Timer	Yes	Minimum Temperature	50 °C
End of cooking acoustic alarm	Yes	Maximum temperature	280 °C

Accessories included for Main Oven & Hob



Cast iron wok support	1	Grill mesh	1
Rack with back and side stop	1	Telescopic Guide rails, partial Extraction	1
20mm deep tray	1	Meat Probe	1
40mm deep tray	1		

Electrical Connection

Plug	(I) Australia	Frequency	50/60 Hz
Electrical connection rating	4200 W	Power supply cable length	120 cm
Current	19 A	Terminal block	5 poles
Voltage	220-240 V		

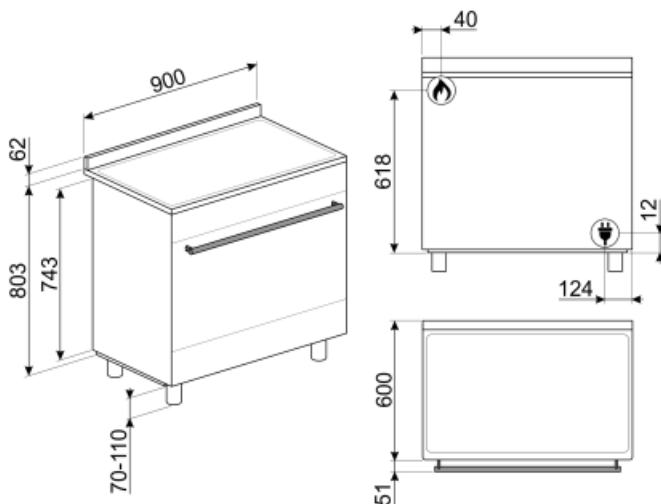

Not included accessories



TPKTR9

Teppanyaki grill plate for Victoria TR9, Master and Sinfonia cookers



SFLK1

Child lock



PRTX

Refractory pizza stone with handles. D=35cm Not suitable for microwave ovens. Suitable for gas ovens, to be put on the griddle.



PPR9

Refractory pizza stone without handles. Squared shaped stone: L64xH2,3xP37,5 cm Suitable also for gas ovens, to be put on the griddle.



KITROT9

Rotisserie kit for 90x60 cookers, new cavity (115 L)



PALPZ

Pizza shovel with fold away handle width: 315mm length : 325mm



GTT

Totally extractable telescopic guides (1 level) Extraction: 433 mm Material: Stainless steel AISI 430 polished



AIRFRY

Air fryer rack AIRFRY . Ideal for recreating traditional frying in the oven, but with fewer calories and less fat. It allows you to cook quickly and simply dishes such as French fries, fried vegetables and fish, ensuring perfect browning and crispiness.



GTP

Partially extractable telescopic guides (1 level) Extraction: 300 mm Material: Stainless steel AISI 430 polished



BGTR9

Cast iron grill plate suitable for 90 cm Victoria, 60 and 90 cm Master and Sinfonia cookers



KITPBX

Height reduction feet (850 mm)



BBQ

Double sided plate BBQ. Suitable for recreating succulent and crispy dishes in the oven with the typical taste of grilled cooking. The ribbed side is particularly suitable for meats and cheeses. The smooth side for fish, seafood and vegetables.



KITPAX



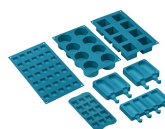











Height extension feet (950 mm), stainless steel, suitable for Master, Sinfonia and Concerto cookers











SMOLD

Set of 7 silicone moulds for ice creams, ice lollies, pralines, ice cubes or to portion food. Usable from -60°C to +230°C

Symbols glossary (TT)

 <p>Heavy duty cast iron pan stands: for maximum stability and strength.</p>	 <p>Air cooling system: to ensure a safe surface temperatures.</p>
 <p>Quadruple glazed: Number of glazed doors.</p>	 <p>Enamel interior: The enamel interior of all Smeg ovens have a special antacid lining which helps keep the interior clean by reducing the amount of cooking grease adhering to it.</p>
 <p>Fingerprint proof stainless steel: Fingerprint proof stainless steel keeps stainless steel looking as good as new.</p>	 <p>Circogas: In gas ovens the fan distributes the heat quickly and evenly throughout the oven cavity, avoiding flavour transfer when cooking a number of different dishes at the same time. In electric ovens this combination completes cooking more quickly of foods that are ready on the surface, but that require more cooking inside, without further browning.</p>
 <p>Fan with upper and lower elements: The elements combined with the fan aim to provide more uniform heat, a similar method to conventional cooking, so pre-heat is required. Most suitable for items requiring slow cooking methods.</p>	 <p>Upper and lower element only: a traditional cooking method best suited for single items located in the centre of the oven. the top pf the oven will always be hottest. Ideal for roast, fruit cakes, bread etc.</p>
 <p>Circulaire: The combination of the fan and circular element around it gives a hot air cooking method. This provides many benefits including no preheat if cook time is more than 20 minutes, no flavour transfer when cooking different foods at the same time, less energy, and shorter cook times. Good for all types of food.</p>	 <p>ECO: The combination of the grill, fan and lower element is particularly suitable for cooking small quantities of food.</p>
 <p>Grill element: Using of grill gives excellent results when cooking meat of medium and small portions, especially when combined with a rotisserie (where possible). Also ideal for cooking sausages and bacon.</p>	 <p>Half grill: For rapid cooking and browning of foods. Best results can be obtained by using the top shelf for small items, the lower shelves for larger ones, such as chops or sausages. For half grill heat is generated only at the centre of the element, so is ideal for smaller quantities.</p>
 <p>Fan with grill element: The fan reduces the fierce heat from the grill, providing an excellent method of grilling various foods, chops, steaks, sausages etc. giving even browning and heat distribution, without drying out the food. The top two levels recommended for use, and the lower part of the oven can be used to keep items warm at the same time, an excellent facility when cooking a grilled breakfast. Half grill (centre portion only) is ideal for small quantities of food.</p>	 <p>Rotisserie: The rotisserie (where installed) works in combination with the grill element to brown foods to perfection.</p>

-
- | | |
|--|---|
|  <p>Circulaire with upper and lower elements: The use of the fan with both elements allows food to be cooked quickly and effectively, ideal for large joints that require thorough cooking. It offers a similar result to rotisserie, moving the heat around the food, instead of moving the food itself, enabling any size or shape to be cooked.</p> |  <p>All glass inner door: All glass inner door, a single flat surface which is simple to keep clean.</p> |
|  <p>The inner door glass: can be removed with a few quick movements for cleaning.</p> |  <p>Side lights: Two opposing side lights increase visibility inside the oven.</p> |
|  <p>Pyrolytic: Pyrolytic cleaning cycles can be selected as necessary to automatically clean the oven interior.</p> |  <p>The oven cavity has 5 different cooking levels.</p> |
|  <p>Telescopic rails: allow you to pull out the dish and check it without having to remove it from the oven entirely.</p> |  <p>Ultra rapid burners: Powerful ultra rapid burners offer up to 5kw of power.</p> |