

## C9IMX2

Cooker size	90x60 cm
N. of cavities with energy label	1
Cavity heat source	ELECTRICITY
Hob type	Induction
Type of main oven	Thermoseal
Cleaning system main oven	Vapour Clean
EAN code	8017709321314
Energy efficiency class	A

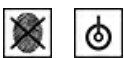









## Aesthetics



<b>Aesthetic</b>	Classic	<b>No. of controls</b>	7
<b>Serie</b>	Sinfonia	<b>Serigraphy colour</b>	Black
<b>Colour</b>	Stainless steel	<b>Type of control setting</b>	Control knobs
<b>Finishing</b>	Satin	<b>Slider</b>	Red
<b>Design</b>	Square design	<b>Handle</b>	Smeg Classic
<b>Door</b>	With 2 horizontal strips	<b>Handle Colour</b>	Brushed stainless steel
<b>Hob colour</b>	Stainless steel	<b>Glass type</b>	eclipse
<b>Command panel finish</b>	Finger friendly stainless steel	<b>Feet</b>	Silver
<b>Control knobs</b>	Smeg Classic	<b>Storage compartment</b>	Door
<b>Controls colour</b>	Stainless steel	<b>Logo</b>	Assembled st/steel
<b>Display</b>	Touch	<b>Logo position</b>	Facia below the oven

## Programs / Functions

<b>No. of cooking functions</b>	9
<b>Traditional cooking functions</b>	

 Static	 Fan assisted	 Circulaire
 Eco	 Small grill	 Large grill
 Fan grill (large)	 Base	 Fan assisted bottom

## Cleaning functions

 Vapour Clean

## Other functions

 Defrost by time

## Hob options



Control lock Yes  
 Limited Power Consumption Mode Yes

Limited Power Consumption Mode in W 3700, 4800, 7400 W  
 Multizone Option Yes

## Hob technical features



Total no. of cook zones 5

Front left - Induction - multizone - 2.10 kW - Booster 2.30 kW - 21.0x19.0 cm

Rear left - Induction - multizone - 1.60 kW - Booster 1.85 kW - 21.0x19.0 cm

Central - Induction - single - 2.30 kW - Booster 3.00 kW - Ø 27.0 cm

Rear right - Induction - single - 1.20 kW - Booster 1.40 kW - Ø 18.0 cm

Front right - Induction - single - 2.30 kW - Booster 3.00 kW - Ø 21.0 cm

No. of cooking zones with Booster	5	Minimum pan diameter indication	Yes
Automatic switch off when overheat	Yes	Selected zone indicator	Yes
Automatic pan detection	Yes	Residual heat indicator	Yes

## Main Oven Technical Features



No. of lights	2	Removable inner door	Yes
Fan number	2	Total no. of door glasses	3
Net volume of the cavity	115 l	No. of thermo-reflective door glasses	2
Gross volume, 1st cavity	129 l	Safety Thermostat	Yes
Cavity material	Ever Clean enamel	Cooling system	Tangential
No. of shelves	5	Usable cavity space dimensions (HxWxD)	371x724x418 mm
Type of shelves	Metal racks	Temperature control	Electro-mechanical
Light type	Halogen	Lower heating element power	1700 W
Light Power	40 W	Upper heating element - Power	1200 W
Cooking time setting	Start and Stop	Grill element	1700 W
Light when oven door is open	Yes		
Door opening	Flap down		
Removable door	Yes		

Full glass inner door	Yes	Large grill - Power	2900 W
		Circular heating element - Power	2 x 1550 W
		Grill type	Electric

## Options Main Oven

Timer	Yes	Minimum Temperature	50 °C
End of cooking acoustic alarm	Yes	Maximum temperature	260 °C

## Accessories included for Main Oven & Hob

Rack with back and side stop	1	Grill mesh	1
20mm deep tray	1	Meat Probe	1
40mm deep tray	1		

## Electrical Connection

Electrical connection rating	10600 W	Power supply cable length	150 cm
Current	46 A	Type of electric cable	Yes, Double and Three Phase
Voltage	220-240 V	Frequency	50/60 Hz
Voltage 2 (V)	380-415 V	Terminal block	5 poles
Type of electric cable installed	Yes, Single phase		

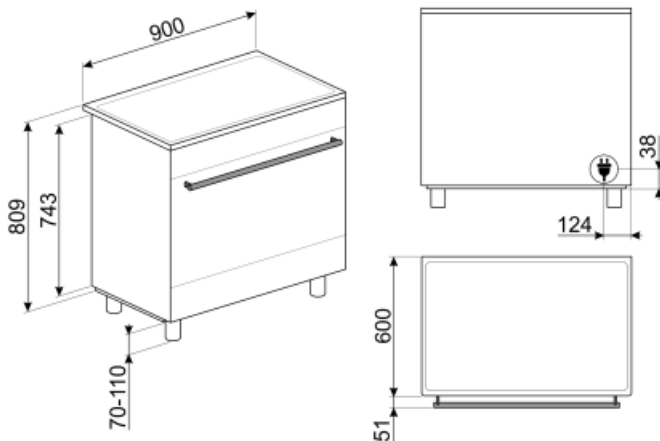

## Not included accessories

### AIRFRY9

Air fryer rack AIRFRY . Ideal for recreating traditional frying in the oven, but with fewer calories and less fat. It allows you to cook quickly and simply dishes such as French fries, fried vegetables and fish, ensuring perfect browning and crispiness.



### SFLK1

Child lock



### PRTX

Refractory pizza stone with handles. D=35cm Not suitable for microwave ovens. Suitable for gas ovens, to be put on the griddle.



### PPR9

Refractory pizza stone without handles. Squared shaped stone: L64xH2,3xP37,5 cm Suitable also for gas ovens, to be put on the griddle.



### KITH900CPF9

Height extension kit (950 mm), suitable for TR4110 cookers



### SCRP

Induction and ceramic hobs and teppanyaki scraper



### TPKPLATE

Universal plate for induction, gas, ceramic and electric hobs. Non-stick surface ideal for cooking fish, eggs and vegetables. Dimensions: 410 X 240 mm.



### PALPZ

Pizza shovel with fold away handle width: 315mm length : 325mm



### KITH95CPF9

Height extension kit (950 mm), suitable for Portofino cookers



### GTP

\*\*Partially extractable telescopic guides (1 level)\*\* Extraction: 300 mm Material: Stainless steel AISI 430 polished



### GRILLPLATE

Universal griddle for induction, gas, ceramic and electric hobs. Non-stick surface ideal for cooking meat, cheese and vegetables. Dimensions: 410 x 240 mm.



### KITPBX

Height reduction feet (850 mm)



### BBQ9



### BBQ

Double sided plate BBQ. Suitable for recreating succulent and crispy dishes in the oven with the typical taste of grilled cooking. The ribbed side is particularly suitable for meats and cheeses. The smooth side for fish, seafood and vegetables.



### KITC9X9-1

Splashback, 90x75 cm, stainless steel, suitable for Portofino, Master and Sinfonia cookers

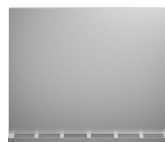

### KITC9X9

Splashback, 90x75 cm, stainless steel, suitable for Master cookers

### GTT

\*\*Totally extractable telescopic guides  
(1 level)\*\* Extraction: 433 mm Material:  
Stainless steel AISI 430 polished







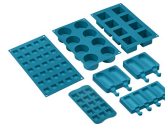























### SMOLD

Set of 7 silicone moulds for ice creams,  
ice lollies, pralines, ice cubes or to  
portion food. Usable from -60°C to  
+230°C



## Symbols glossary (TT)

 <p>Power booster: option allows the zone to work at full power when very intense cooking is necessary.</p>	 <p>Child lock: some models are fitted with a device to lock the programme/cycle so it cannot be accidentally changed.</p>
 <p>Air cooling system: to ensure a safe surface temperatures.</p>	 <p>Defrost by time: with this function the time of thawing of foods are determined automatically.</p>
 <p>A: Product drying performance, measured from A+++ to D / G depending on the product family</p>	 <p>Triple glazed doors: Number of glazed doors.</p>
 <p>ECO-logic: option allows you to restrict the power limit of the appliance real energy saving.</p>	 <p>Enamel interior: The enamel interior of all Smeg ovens have a special antacid lining which helps keep the interior clean by reducing the amount of cooking grease adhering to it.</p>
 <p>Fingerprint proof stainless steel: Fingerprint proof stainless steel keeps stainless steel looking as good as new.</p>	 <p>Circogas: In gas ovens the fan distributes the heat quickly and evenly throughout the oven cavity, avoiding flavour transfer when cooking a number of different dishes at the same time. In electric ovens this combination completes cooking more quickly of foods that are ready on the surface, but that require more cooking inside, without further browning.</p>
 <p>Fan with upper and lower elements: The elements combined with the fan aim to provide more uniform heat, a similar method to conventional cooking, so pre-heat is required. Most suitable for items requiring slow cooking methods.</p>	 <p>Knobs control</p>
 <p>Upper and lower element only: a traditional cooking method best suited for single items located in the centre of the oven. the top pf the oven will always be hottest. Ideal for roast, fruit cakes, bread etc.</p>	 <p>Lower heating element only: This function is ideal for foods that require extra base temperature without browning, e.g. pastry dishes, pizza. Also suitable for slow cooking of stews and casseroles.</p>
 <p>Circulaire: The combination of the fan and circular element around it gives a hot air cooking method. This provides many benefits including no preheat if cook time is more than 20 minutes, no flavour transfer when cooking different foods at the same time, less energy, and shorter cook times. Good for all types of food.</p>	 <p>ECO: The combination of the grill, fan and lower element is particularly suitable for cooking small quantities of food.</p>
 <p>Grill element: Using of grill gives excellent results when cooking meat of medium and small portions, especially when combined with a rotisserie (where possible). Also ideal for cooking sausages and bacon.</p>	 <p>Half grill: For rapid cooking and browning of foods. Best results can be obtained by using the top shelf for small items, the lower shelves for larger ones, such as chops or sausages. For half grill heat is generated only at the centre of the element, so is ideal for smaller quantities.</p>

- 
- |  |  |
|--|--|
|  <p>Fan with grill element: The fan reduces the fierce heat from the grill, providing an excellent method of grilling various foods, chops, steaks, sausages etc. giving even browning and heat distribution, without drying out the food. The top two levels recommended for use, and the lower part of the oven can be used to keep items warm at the same time, an excellent facility when cooking a grilled breakfast. Half grill (centre portion only) is ideal for small quantities of food.</p> |  <p>Overheat protection: The safety system that automatically turns off the hob in case of overheating of the control unit.</p> |
|  <p>Induction: The work of these hobs is based on the principle of electromagnetic induction. The heat is generated directly in the bottom of the pan during its contact with the hob.</p>   |  <p>All glass inner door: All glass inner door, a single flat surface which is simple to keep clean.</p>                        |
|  <p>The inner door glass: can be removed with a few quick movements for cleaning.</p>  |  <p>Side lights: Two opposing side lights increase visibility inside the oven.</p>  |
|  <p>Indication of residual heat: After the glass ceramic hob is switched off the residual heat indicator shows which of the heating zones still remains hot. When the temperature drops below 60 ° C, the indicator goes out.</p>  |  <p>The oven cavity has 5 different cooking levels.</p>   |
|  <p>Vapour Clean: a simple cleaning function using steam to loosen deposits in the oven cavity.</p>  |  <p>The capacity indicates the amount of usable space in the oven cavity in litres.</p>                                       |