

Collection: Elevate

Corner freestanding bath – 1500 mm

Features

Sleek and practical, this minimalist design combines the beauty of a freestanding bath with the practicality of a bath that sits flush against two corner walls. Perfect for compact bathrooms. Sits flush against corner walls

- Seamless design
- White sanitary grade acrylic, White Gloss
- Excellent heat retention properties
- Adjustable support feet

Available in 3 configuration options

- **OPTION 1** Bath with No Overflow
- **OPTION 2** Bath with Overflow
- **OPTION 3** Bath with Smartfill System (bath filler and overflow)

Installation

Refer to installation instructions.

The bath is supplied with four adjustable support feet on the base frame of the bath. Position the bath and use the adjustable feet to level the bath. Leave a 3mm void between the base of the bath and the floor. Use silicone seal around the base to seal the bath to the floor. Allow a 20mm gap in the silicone seal as a weephole (gap is designed to reveal any plumbing leakage).

Use acetic cured silicone sealant. Do not use epoxy type adhesives.

Order codes

See next page for order codes.



Left corner bath



Right corner bath

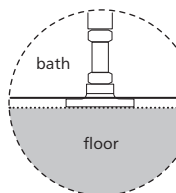
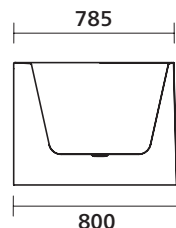
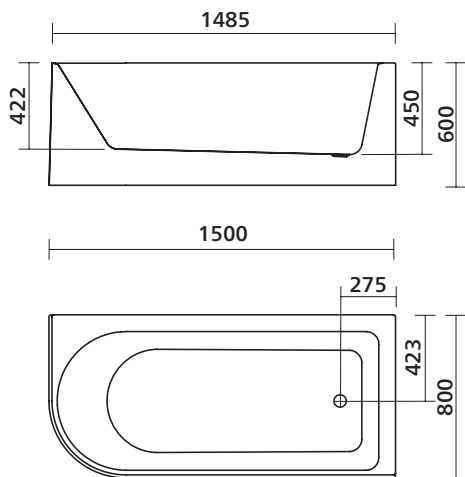

Leave a 3mm gap between base of bath and floor. Use silicone to seal base of bath to floor, leaving a 20mm weephole.

SEIMA

kitchen + laundry + bathroom ware

seima.com.au

Please note

- All measurements are in millimetres.
- Dimensions are nominal and subject to normal manufacturing variations.
- Fixing: Use silicone sealant. Do not use epoxy type adhesives.
- Specifications may vary without notice as part of our continuous improvement practices.
- Clean with a damp cloth. Do not use abrasive cleaners, liquids or pastes.



Scan to view bath on our website

Plati 110 – Order Codes

Order codes

OPTION 1 Plati 110 bath with No Overflow

Bath only – No Overflow

192161	Plati 110, Left Corner
192163	Plati 110, Right Corner

OPTIONAL EXTRA — ORDER SEPARATELY

Bath Installation Kit + Pop-out Waste to suit Non-Overflow bath

FlexiWaste Installation Kit with premium Pop-out Bath Waste, with colour options, is available as an optional extra.

192179	FlexiWaste Bath Installn Kit w Pop-out Waste, no OF, Chrome
192329	FlexiWaste Bath Installn Kit w Pop-out Waste, no OF, Brushed Nickel
192332	FlexiWaste Bath Installn Kit w Pop-out Waste, no OF, Gunmetal
192333	FlexiWaste Bath Installn Kit w Pop-out Waste, no OF, Brushed Gold
192331	FlexiWaste Bath Installn Kit w Pop-out Waste, no OF, White Gloss
192458	FlexiWaste Bath Installn Kit w Pop-out Waste, no OF, White Matte
192330	FlexiWaste Bath Installn Kit w Pop-out Waste, no OF, Black Matte

Option 1 – Order Bath and Installation Kit separately.

Installation Kit – Non-overflow:

FlexiWaste Installation Kit with premium Pop-out Bath Waste. Colour options:

- Chrome
- Brushed Nickel
- Gunmetal
- Brushed Gold
- White Gloss
- White Matte
- Black Matte

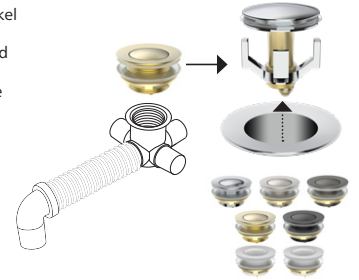

OPTION 2 Plati 110 bath with Overflow

Bath with Overflow includes FlexiWaste Installation Kit with premium Pop-out Bath Waste and Dome Overflow with colour options.

192842	Plati 110, Left Cnr + FlexiWaste Bath Installn Kit w OF + Pop-out Waste, Chrome
192843	Plati 110, Left Cnr + FlexiWaste Bath Installn Kit w OF + Pop-out Waste, Brushed Nickel
192844	Plati 110, Left Cnr + FlexiWaste Bath Installn Kit w OF + Pop-out Waste, Gunmetal
192845	Plati 110, Left Cnr + FlexiWaste Bath Installn Kit w OF + Pop-out Waste, Brushed Gold
192846	Plati 110, Left Cnr + FlexiWaste Bath Installn Kit w OF + Pop-out Waste, White Gloss
192847	Plati 110, Left Cnr + FlexiWaste Bath Installn Kit w OF + Pop-out Waste, White Matte
192848	Plati 110, Left Cnr + FlexiWaste Bath Installn Kit w OF + Pop-out Waste, Black Matte
192849	Plati 110, Right Cnr + FlexiWaste Bath Installn Kit w OF + Pop-out Waste, Chrome
192850	Plati 110, Right Cnr + FlexiWaste Bath Installn Kit w OF + Pop-out Waste, Brushed Nickel
192851	Plati 110, Right Cnr + FlexiWaste Bath Installn Kit w OF + Pop-out Waste, Gunmetal
192852	Plati 110, Right Cnr + FlexiWaste Bath Installn Kit w OF + Pop-out Waste, Brushed Gold
192853	Plati 110, Right Cnr + FlexiWaste Bath Installn Kit w OF + Pop-out Waste, White Gloss
192854	Plati 110, Right Cnr + FlexiWaste Bath Installn Kit w OF + Pop-out Waste, White Matte
192855	Plati 110, Right Cnr + FlexiWaste Bath Installn Kit w OF + Pop-out Waste, Black Matte

Option 2 – Includes Bath and FlexiWaste Installation Kit with Overflow and Pop-out Waste.

Installation Kit with Overflow:

Includes premium Pop-out Bath Waste and Overflow Dome. Colour options:

- Chrome
- Brushed Nickel
- Gunmetal
- Brushed Gold
- White Gloss
- White Matte
- Black Matte

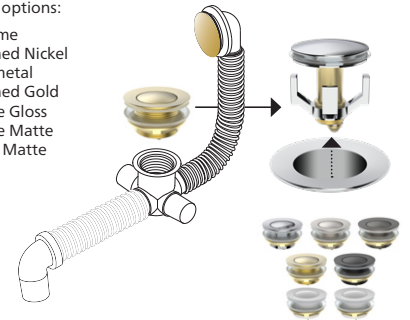

OPTION 3 Plati 110 bath with Smartfill system (bath filler + overflow)

Option 3, Smartfill: A revolutionary new bath filler and overflow system by Seima. The Smartfill system includes filler, overflow and premium Pop-out Bath Waste.

Your Smartfill bath will be supplied with the Smartfill head and connecting hoses pre-installed, ready for on-site installation.

The Smartfill bezel and bath waste are available in a range of colours.

192570	Plati 110, Left Cnr, Smartfill, Brushed Nickel
192571	Plati 110, Left Cnr, Smartfill, Gunmetal
192572	Plati 110, Left Cnr, Smartfill, Brushed Gold
192573	Plati 110, Left Cnr, Smartfill, Black
192574	Plati 110, Right Cnr, Smartfill, Brushed Nickel
192575	Plati 110, Right Cnr, Smartfill, Gunmetal
192576	Plati 110, Right Cnr, Smartfill, Brushed Gold
192577	Plati 110, Right Cnr, Smartfill, Black

IMPORTANT

Please refer to the following page, **Planning Guide for baths installed with Smartfill**, for essential information about Smartfill planning and pre-lay requirements.

Option 3 – Smartfill System

Smartfill System includes Filler, Overflow and Installation Kit:

Includes Bath, stainless steel Smartfill Bezel (filler at top, overflow at bottom), and premium Pop-out Bath Waste, and installation kit. Colour options:

- Brushed Nickel
- Gunmetal
- Brushed Gold
- Black Matte



SEIMA

kitchen + laundry + bathroom ware

seima.com.au

Please note

- All measurements are in millimetres.
- Dimensions are nominal and subject to normal manufacturing variations.
- Fixing: Use silicone sealant. Do not use epoxy type adhesives.
- Specifications may vary without notice as part of our continuous improvement practices.
- Clean with a damp cloth. Do not use abrasive cleaners, liquids or pastes.

Flexiwaste Bath Installation Kit with Overflow and Pop-out Bath Waste



Colour options



Pop-out bath waste

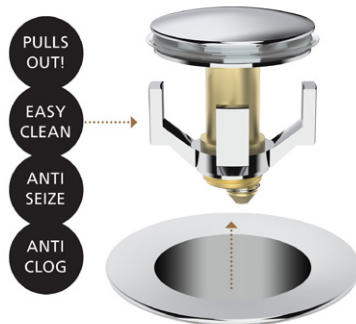

Overflow dome

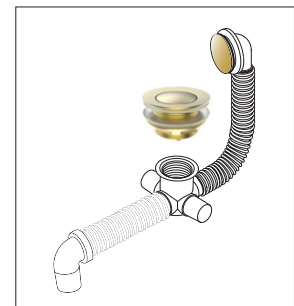

Note: The above bath design is for illustration purposes only.
Location of overflow will depend on bath design.

SEIMA

kitchen + laundry + bathroom ware

Planning Guide for baths to be installed with

Smartfill®

Bath filler + overflow by Seima

Important !

Must be installed by a licensed plumber in accordance with Australian Standard AS3500 and meet all requirements of local licensing authorities.

Smartfill system includes FlexiWaste overflow kit with Pop-out bath waste

Smartfill Planning + Pre-lay Guide

The plumbing set-up for Smartfill normally requires advance planning, to place the plumbing inlet and outlet in the best positions for your bath location.

The Smartfill system simply requires the plumbing to be placed under the bath within the bath footprint:

- **Water Inlet Point**
1/2" BSP nipple — to protrude a minimum of 30mm above FFL (finished floor level).
(This water point will be controlled via a wall mixer or other tapware, to fill the bath.)
- **DWV Bath Sewer Point**
Water outlet

The water inlet nipple and waste outlet pipe can be placed anywhere within the footprint of the bath and there must be sufficient clearance for connection pipes. The recommended distance between the Water Inlet Point and DWV Point is around 200mm but this is not essential.

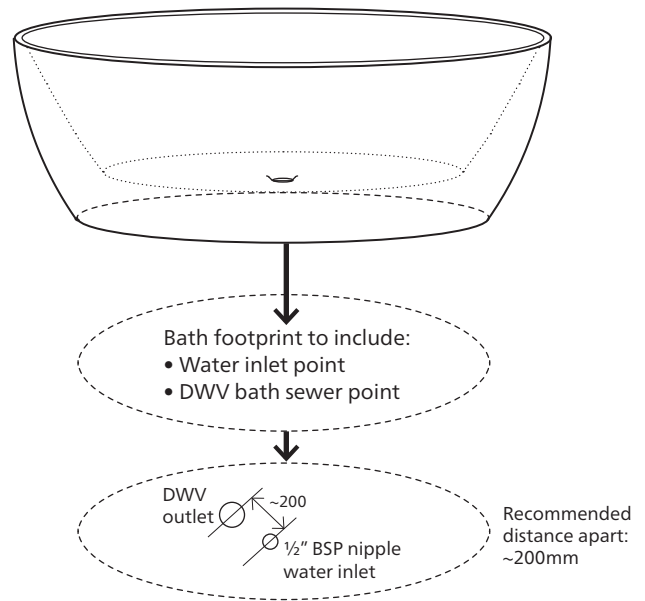

Smartfill bath filler + overflow system

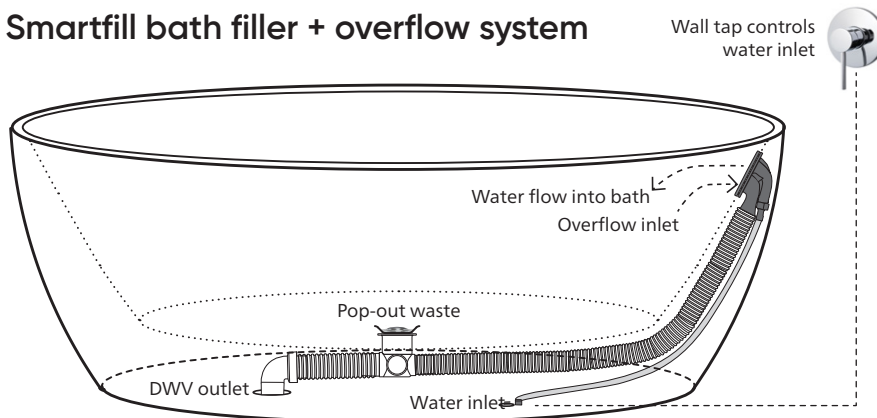

Smartfill has two elements of backflow prevention built in to the device. Smartfill passes AS2845:2:1996 for backflow prevention with included air gap and also has a dual check valve (DualCV). WM Cert 23422.

SEIMA

kitchen + laundry + bathroom ware

seima.com.au



WaterMark

WMTS 040 LN 23422
ID: 192130, 191992,
191993



Designed and made in Australia
by Seima. This Seima innovation
is a patented, registered design.