







# Bathroom Extras – data sheet set

This data sheet set includes:









- Basin wastes + bottle traps
- Bath wastes, bath waste kits + bath overflow kits

## Contents

### Basin wastes and bottle traps

 <p>p2</p>  <p><b>Pop-out Basin Waste</b> Colour options PAGE 2</p>	 <p>p4</p>  <p><b>Ceramic Pop-out Basin Waste</b> Colour options</p>	 <p>p5</p> <p><b>Pop-up Basin Waste</b> Chrome</p>	 <p>p6</p>  <p><b>Bottle Trap</b> Colour options</p>
---	--	---	--

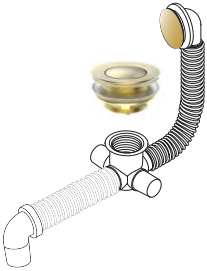
### Bath wastes, bath waste kits, bath overflow waste kits

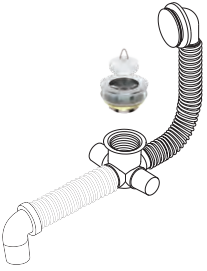
 <p>p7</p>  <p><b>Pop-out Bath Waste</b> Non-overflow and Overflow options Colour options</p>	 <p>p9</p>  <p><b>FlexiWaste Bath Waste Pop-out Kit</b> Premium bath waste kit with pop-out waste Suits non-overflow + integrated overflow baths Colour options</p>	 <p>p10</p> <p><b>FlexiWaste Bath Waste Kit Basic</b> Basic bath waste kit Suits non-overflow baths only Chrome plug and waste</p>
 <p>p8</p> <p><b>Bath Plug + Waste</b> Non-overflow Chrome, white rubber</p>	 <p>p11</p>  <p><b>FlexiWaste Bath Overflow Pop-out Kit</b> Premium overflow kit with pop-out waste Colour options</p>	 <p>p12</p> <p><b>FlexiWaste Bath Overflow Kit Basic</b> Basic bath overflow waste kit Chrome plug and waste</p>

# SEIMA

kitchen + laundry + bathroom ware

seima.com.au

**Please note**

- All measurements are in millimetres.
- Use silicone sealant. Do not use epoxy type adhesives.
- Specifications may vary without notice as part of our continuous improvement practices.
- Clean with a damp cloth. Do not use abrasive cleaners, liquids or pastes.

# Pop-out Basin Waste



## POP OUT basin waste



### Innovative easy-to-remove pop-out design

#### Why pop-out?

The Pop-out waste does exactly what its name suggests — the top section of the waste simply pops out (or pulls out). This patented innovation has significant advantages including:

- **REMOVABLE** The top of the waste is completely removable. Easy access, easy cleaning.
- **ANTI CLOG** The 'prongs' on the top section of the waste are designed to catch debris (including hair) as it flows into the waste. The streamlined simplicity of this design makes it easy to keep clear and clean.
- **ANTI SEIZE** The pop-out design eliminates the possibility of the plug seizing in the waste.
- **OPEN DESIGN** The openness of the design promotes efficient drainage.
- **COMPATIBLE** with Lithos natural stone waste caps (supplied with Lithos basins).

#### More features

- **PREMIUM QUALITY** Durable, high quality finish — all components are premium quality.
- **SEIMA UNIVERSAL DESIGN** Suits 32 and 40 mm waste holes; suits overflow and non-overflow.

#### Order codes

192010	Pop-out Basin Waste — Chrome
192012	Pop-out Basin Waste — Brushed Nickel
192199	Pop-out Basin Waste — Gunmetal
192013	Pop-out Basin Waste — Brushed Gold
192009	Pop-out Basin Waste — White Matte
192011	Pop-out Basin Waste — Black Matte

Compatible with natural stone waste caps supplied with natural stone basins. Simply screw off the metal cap and replace it with the natural stone cap.

#### Product details

<b>WASTE OUTLET</b>	Universal. Suits 32 and 40 mm waste holes. Suits overflow and non-overflow.
<b>FIXING</b>	Must be fitted by a licensed plumber. Warranty does not cover any fault caused by installation or part installation by an unlicensed person. Please refer to the diagram for installation guidelines. It is essential that the waste is sealed correctly using silicone where shown.
<b>MATERIALS</b>	Solid brass base, plated/coated to achieve the colour finishes. The transparent flexible ring is premium quality.
<b>CLEANING</b>	Clean with soapy water. Do not use corrosive or abrasive cleaners.

### Easy to install

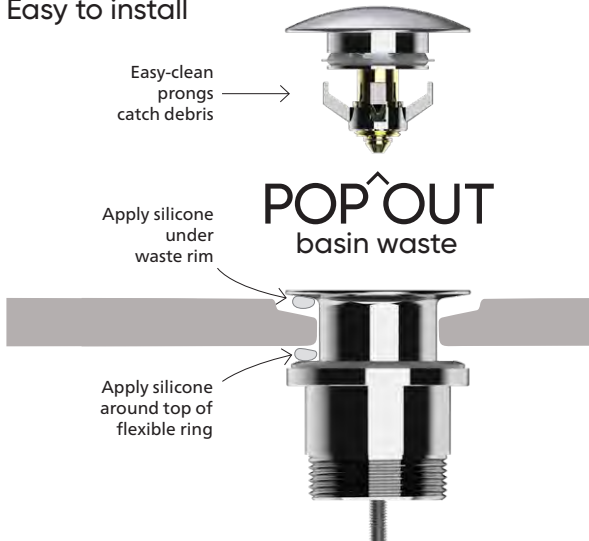

# SEIMA

kitchen + laundry + bathroom ware

seima.com.au

#### Please note

- All measurements are in millimetres.
- Use silicone sealant. Do not use epoxy type adhesives.
- Specifications may vary without notice as part of our continuous improvement practices.
- Clean with a damp cloth. Do not use abrasive cleaners, liquids or pastes.

# Pop-out Basin Waste – Installation Guide

Please refer to the diagram for specific guidelines.

- It is essential that the waste is sealed correctly using silicone where shown.
- Must be fitted by a licensed plumber. The Seima warranty does not cover any fault caused by installation or part installation by an unlicensed person.
- Clean with soapy water. Do not use corrosive or abrasive cleaners.

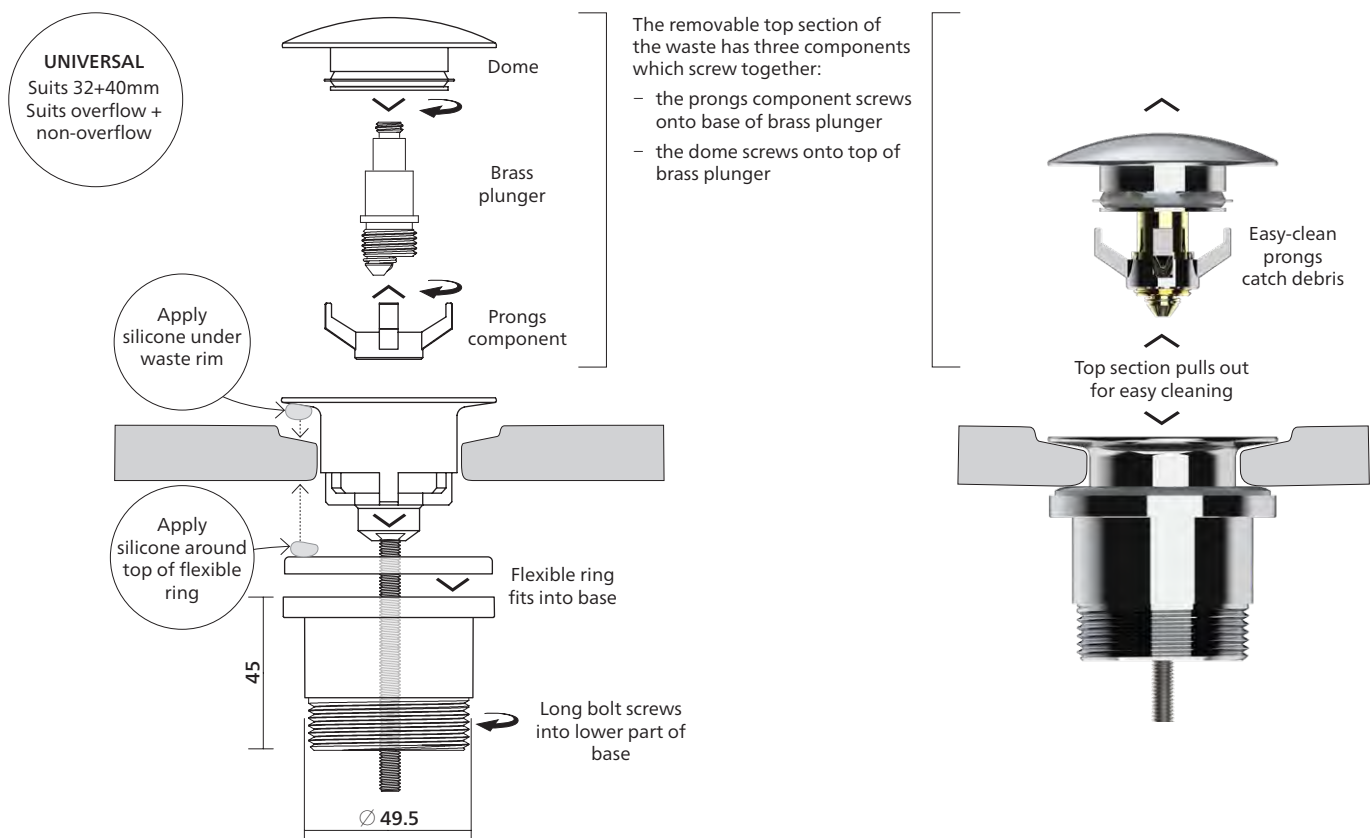

# SEIMA

kitchen + laundry + bathroom ware

seima.com.au

#### Please note

- All measurements are in millimetres.
- Use silicone sealant. Do not use epoxy type adhesives.
- Specifications may vary without notice as part of our continuous improvement practices.
- Clean with a damp cloth. Do not use abrasive cleaners, liquids or pastes.

# Ceramic Pop-out Basin Waste



White Gloss    White Silk Matte    Black Silk Matte    Smoky Taupe Silk Matte    Winter Sea Silk Matte    Rose Quartz Silk Matte    Forest Silk Matte

## POP OUT

basin waste  ceramic cap

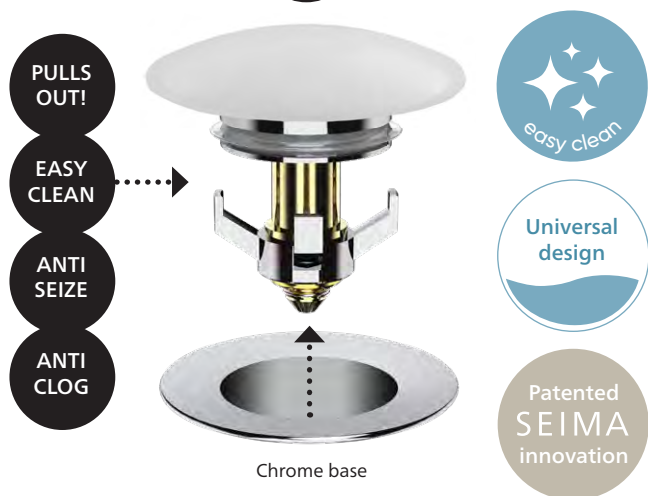

Chrome base



### Ceramic waste cap and chrome pop-out base

Ceramic wastes offer a streamlined look for your ceramic basins. You can match the waste with your basin or choose a contrasting colour (eg black dome on white basin).

- The ceramic waste cap simply screws onto the pop-out base.
- Pop-out base has chrome finish.

### Innovative easy-to-remove pop-out design

#### Why pop-out?

The Pop-out waste does exactly what its name suggests — the top section of the waste simply pops out (or pulls out). This patented innovation has significant advantages including:

- **REMOVABLE** The top of the waste is completely removable. Easy access, easy cleaning.
- **ANTI CLOG** The 'prongs' on the top section of the waste are designed to catch debris (including hair) as it flows into the waste. The streamlined simplicity of this design makes it easy to keep clear and clean.
- **ANTI SEIZE** The pop-out design eliminates the possibility of the plug seizing in the waste.
- **OPEN DESIGN** The openness of the design promotes efficient drainage.

#### More features

- **PREMIUM QUALITY** Durable, high quality finish — all components are premium quality.
- **SEIMA UNIVERSAL DESIGN** Suits 32 and 40 mm waste holes; suits overflow and non-overflow.

#### Order codes

192257	Ceramic Pop-out Basin Waste, White Silk Matte
192258	Ceramic Pop-out Basin Waste, White Gloss
192259	Ceramic Pop-out Basin Waste, Black Silk Matte
192260	Ceramic Pop-out Basin Waste, Rose Quartz
192261	Ceramic Pop-out Basin Waste, Smoky Taupe
192262	Ceramic Pop-out Basin Waste, Winter Sea
192263	Ceramic Pop-out Basin Waste, Forest

#### Product details

WASTE OUTLET	Universal. Suits 32 and 40 mm waste holes. Suits overflow and non-overflow.
FIXING	Must be fitted by a licensed plumber. Warranty does not cover any fault caused by installation or part installation by an unlicensed person. Please refer to the diagram for installation guidelines. It is essential that the waste is sealed correctly using silicone where shown.
MATERIALS	Solid brass base, chrome plated. Ceramic cap.
CLEANING	Clean with soapy water. Do not use corrosive or abrasive cleaners.



# SEIMA

kitchen + laundry + bathroom ware

seima.com.au

#### Please note

- All measurements are in millimetres.
- Use silicone sealant. Do not use epoxy type adhesives.
- Specifications may vary without notice as part of our continuous improvement practices.
- Clean with a damp cloth. Do not use abrasive cleaners, liquids or pastes.

# Pop-up Basin Waste



## Button design, chrome finish, universal

### Order codes

191825	Button pop-up waste, chrome, PVC base	Old code: SVA-050
191826	Button pop-up waste, chrome, chrome base	Old code: SVA-050-B

### Usage note

Pop-up wastes have a choice of base material, depending on the use. The PVC base is for general use. The metal base (chrome) is designed for use with a bottle trap.

### Product details

**WASTE OUTLET** Universal, suits 32 and 40 mm waste holes, suits overflow and non-overflow.

**FIXING** Must be fitted by a licensed plumber. Warranty does not cover any fault caused by installation or part installation by an unlicensed person.

Refer to the diagram below for installation guidelines.

**MATERIALS** Chrome plated solid brass. PVC base or metal base.

**CLEANING** Clean with soapy water. Do not use corrosive or abrasive cleaners.

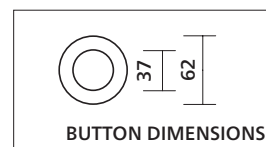
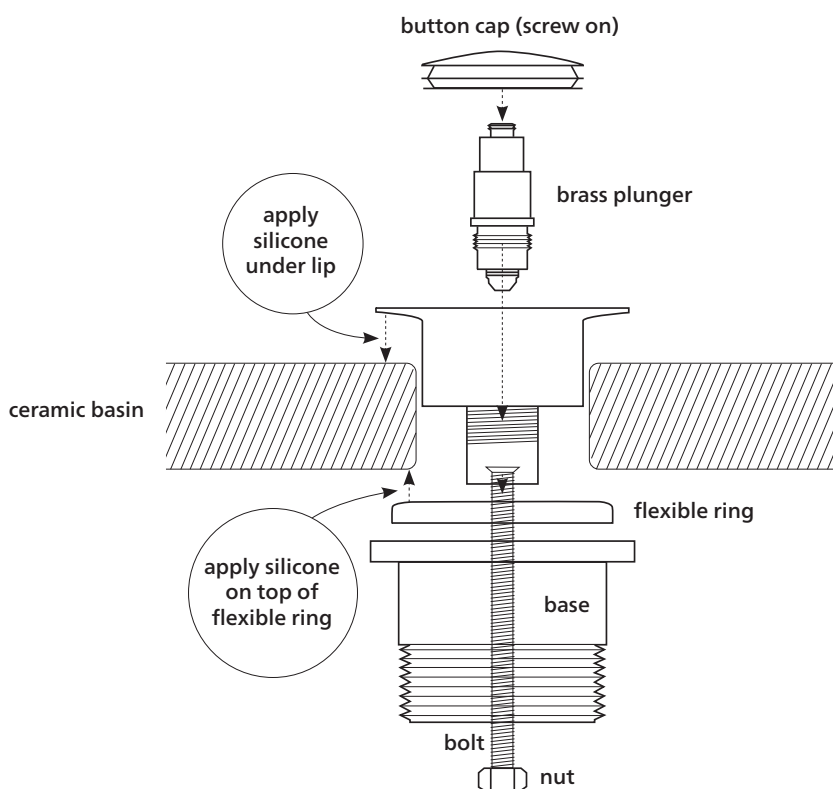

# SEIMA

kitchen + laundry + bathroom ware

seima.com.au

### Please note

- All measurements are in millimetres.
- Use silicone sealant. Do not use epoxy type adhesives.
- Specifications may vary without notice as part of our continuous improvement practices.
- Clean with a damp cloth. Do not use abrasive cleaners, liquids or pastes.

# Bottle Trap

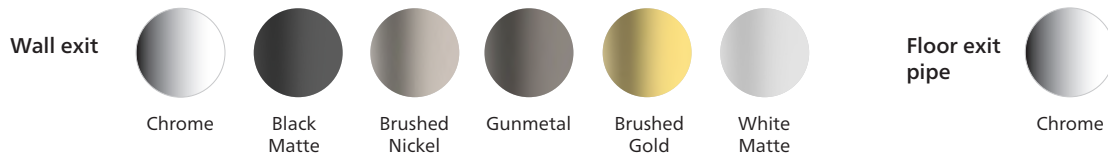

Wall exit

Floor exit pipe available in Chrome.  
Note: Pipe only – pipe to be used in conjunction with wall exit bottle trap.

## Bottle trap for wall basins and basins with exposed plumbing

- Wall exit available in multiple colours
- Floor exit available in Chrome only
- Solid brass base
- Suits 40 mm waste holes

### Order codes

WALL EXIT	
191822	Bottle trap, wall exit, Chrome
192120	Bottle trap, wall exit, Brushed Nickel
192200	Bottle trap, wall exit, Gunmetal
192121	Bottle trap, wall exit, Brushed Gold
192122	Bottle trap, wall exit, White Matte
191836	Bottle trap, wall exit, Black Matte

FLOOR EXIT – PIPE ONLY – CHROME	
191824	Chrome floor exit pipe

### Product details

WASTE	Suits 40 mm wastes.
FIXING	Must be fitted by a licensed plumber. Warranty does not cover any fault caused by installation or part installation by an unlicensed person. Ensure all o-rings are lubricated with silicone based lubricant. Fit connection pipe to plug and washer. Adjust trap height (trim connection pipe as required) to line up with wall outlet pipe and ensure there is a minimum 1.5 degree fall in the outlet pipe when installed. Measure and trim outlet pipe, ensuring there is adequate allowance for pipe and rubber seal to fit into DWV female socket. Fit rubber seal over outlet pipe and fit into 40mm DWV female socket. Fit protective cover over outlet pipe prior to final connection to plumbing. Firmly tighten all joints. Do not over-tighten. Test for leaks.
CLEANING	Clean with soapy water. Do not use corrosive or abrasive cleaners.
MATERIAL	Brass alloy base.

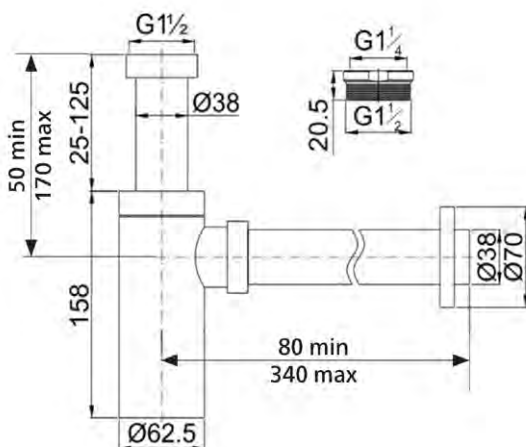

# SEIMA

kitchen + laundry + bathroom ware

seima.com.au

### Please note

- All measurements are in millimetres.
- Use silicone sealant. Do not use epoxy type adhesives.
- Specifications may vary without notice as part of our continuous improvement practices.
- Clean with a damp cloth. Do not use abrasive cleaners, liquids or pastes.



# Pop-out Bath Waste



## POP-OUT bath waste

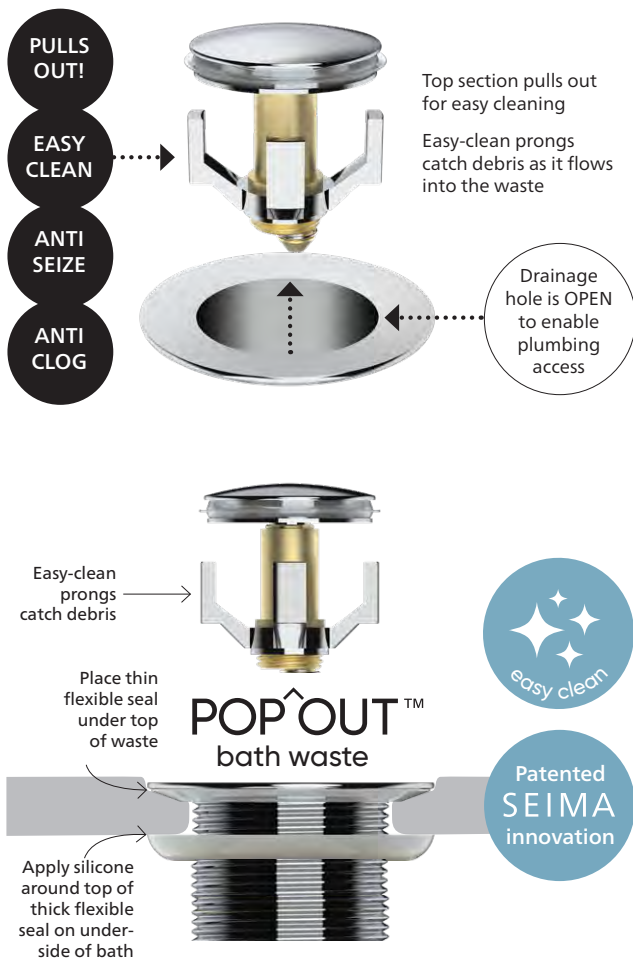

### Innovative easy-to-remove pop-out design

#### Why pop-OUT?

The pop-out waste does exactly what its name suggests — the top section of the waste simply pops out (or pulls out). This patented innovation has significant advantages including:

- **REMOVABLE** The top of the waste is completely removable. Easy access, easy cleaning.
- **ANTI CLOG** The ‘prongs’ on the top section of the waste catch debris (including hair) as it flows into the waste. The streamlined simplicity of this design makes it easy to keep clear and clean.
- **ANTI SEIZE** The pop-out design eliminates the possibility of the plug seizing in the waste.
- **OPEN DESIGN** The openness of the design promotes efficient drainage.
- **PREMIUM QUALITY** Durable, high quality finish — all components are premium quality.
- **OVERFLOW OPTION** Available for overflow and non-overflow baths.
- 40 mm hole – standard size for bath wastes.
- Connects to Australian Standard pipework.
- Drains faster than a pop-up/-down waste.

#### Order codes

- SUIT ALL FLEXIWASTE KITS
- SUIT NON-OVERFLOW BATHS

192014	Pop-out Bath Waste — Chrome
192016	Pop-out Bath Waste — Brushed Nickel
192201	Pop-out Bath Waste — Gunmetal
192017	Pop-out Bath Waste — Brushed Gold
192197	Pop-out Bath Waste — White Gloss
192059	Pop-out Bath Waste — White Matte
192015	Pop-out Bath Waste — Black Silk Matte

#### • SUIT BATHS WITH INTEGRATED OVERFLOW

192023	Pop-out Bath Waste, Overflow — Chrome
192025	Pop-out Bath Waste, Overflow — Brushed Nickel
192202	Pop-out Bath Waste, Overflow — Gunmetal
192026	Pop-out Bath Waste, Overflow — Brushed Gold
192198	Pop-out Bath Waste, Overflow — White Gloss
192060	Pop-out Bath Waste, Overflow — White Matte
192024	Pop-out Bath Waste, Overflow — Black Silk Matte

#### Product details

**WASTE OUTLET** Suits 40 mm waste holes.

**FIXING** Must be fitted by a licensed plumber. Warranty does not cover any fault caused by installation or part installation by an unlicensed person. Please refer to the diagram for installation guidelines. It is essential that the waste is sealed correctly using silicone where shown.

**MATERIALS** Solid brass base, plated/coated to achieve the colour finishes. The transparent flexible ring is premium quality.

**CLEANING** Clean with soapy water. Do not use corrosive or abrasive cleaners.



# SEIMA

kitchen + laundry + bathroom ware

seima.com.au

#### Please note

- All measurements are in millimetres.
- Use silicone sealant. Do not use epoxy type adhesives.
- Specifications may vary without notice as part of our continuous improvement practices.
- Clean with a damp cloth. Do not use abrasive cleaners, liquids or pastes.

# Bath Plug + Waste



## Chrome waste + white rubber plug

- Durable, high quality finish.
- Chrome plated solid brass body and white rubber plug.
- Suits non-overflow baths and FlexiWaste kits.
- 40 mm hole – standard size for bath wastes.
- Connects to Australian Standard pipework.

## Order code

192007 Bath waste and rubber plug (no overflow)

## Product details

WASTE OUTLET Suits 40 mm waste holes.

**FIXING** Must be fitted by a licensed plumber. Warranty does not cover any fault caused by installation or part installation by an unlicensed person.

Please refer to the diagram for installation guidelines. It is essential that the waste is sealed correctly using silicone where shown.

**MATERIALS** Solid brass base with chrome finish. Rubber plug.

**CLEANING** Clean with soapy water. Do not use corrosive or abrasive cleaners.

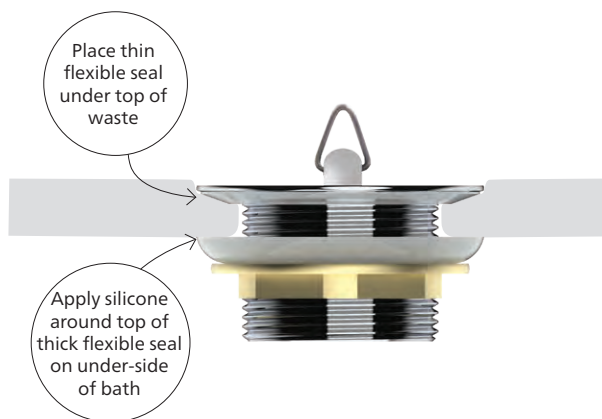

# SEIMA

kitchen + laundry + bathroom ware

seima.com.au

## Please note

- All measurements are in millimetres.
- Use silicone sealant. Do not use epoxy type adhesives.
- Specifications may vary without notice as part of our continuous improvement practices.
- Clean with a damp cloth. Do not use abrasive cleaners, liquids or pastes.



# FlexiWaste Bath Overflow Pop-out Kit

## FlexiWaste

Bath Overflow Pop-out Kit

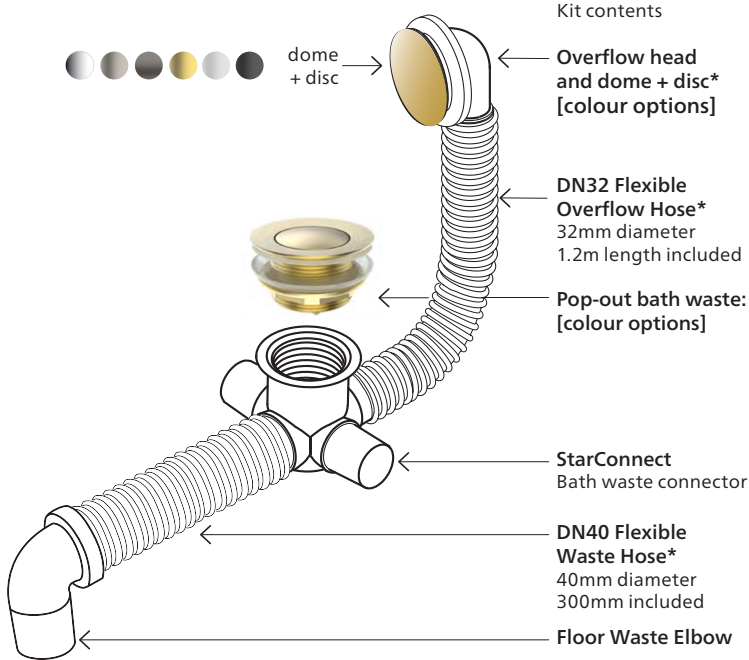

\* Longer hose lengths available separately. The overflow head comes with a chrome finish dome as standard. Colour dome and disc replace standard fittings.

### FlexiWaste premium bath overflow kit

#### Kit includes

- Premium Pop-out Bath Waste – colour options
- Overflow dome – colour options
- Overflow kit

FlexiWaste offers a universal ultra-compact bath waste solution. The innovative StarConnect bath waste connector has an ultra-low 75mm profile under the bath, and multi-directional input and outlet options.

#### Order codes

192235	FlexiWaste Bath OF Pop-out Kit, Brushed Nickel
192236	FlexiWaste Bath OF Pop-out Kit, Black Silk Matte
192237	FlexiWaste Bath OF Pop-out Kit, White Gloss
192457	FlexiWaste Bath OF Pop-out Kit, White Matte
192238	FlexiWaste Bath OF Pop-out Kit, Gunmetal
192239	FlexiWaste Bath OF Pop-out Kit, Brushed Gold
192240	FlexiWaste Bath OF Pop-out Kit, Chrome

#### Optional extra hose – Spare parts

192175	DN40 Flexible waste hose, 300mm long
192209	DN40 Flexible waste hose, 500mm long
192210	DN40 Flexible waste hose, 1.0m long
192176	DN32 Flexible overflow hose, 1.2m long
192208	DN32 Flexible overflow hose, 2.0m long

#### Product details

<b>MATERIALS</b>	StarConnect connector, floor waste elbow – PVC. Waste – Metal. Flexible hose – Corrugated PVC. Overflow head – Metal (chrome finish), PVC, rubber seal.
<b>INSTALLATION</b>	Please refer to installation instructions.
<b>CLEANING</b>	Clean with soapy water. Do not use corrosive or abrasive cleaners.



### The StarConnect advantage

Ultra-compact bath waste connector

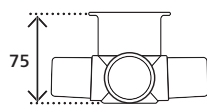

**1** Ultra-low 75mm profile under bath

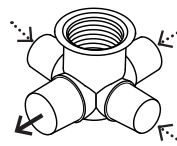

**2** Multi-directional input + outlet options

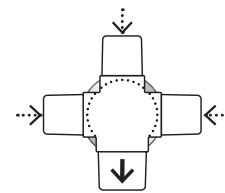

**3** Knock-out openings on all three DN32 spigots



Designed and made in Australia by SEIMA. This SEIMA innovation is a patented, registered design.

# SEIMA

kitchen + laundry + bathroom ware

seima.com.au

#### Please note

- All measurements are in millimetres.
- Use silicone sealant. Do not use epoxy type adhesives.
- Specifications may vary without notice as part of our continuous improvement practices.
- Clean with a damp cloth. Do not use abrasive cleaners, liquids or pastes.

# FlexiWaste Bath Overflow Kit Basic

## FlexiWaste

Bath Overflow Kit Basic

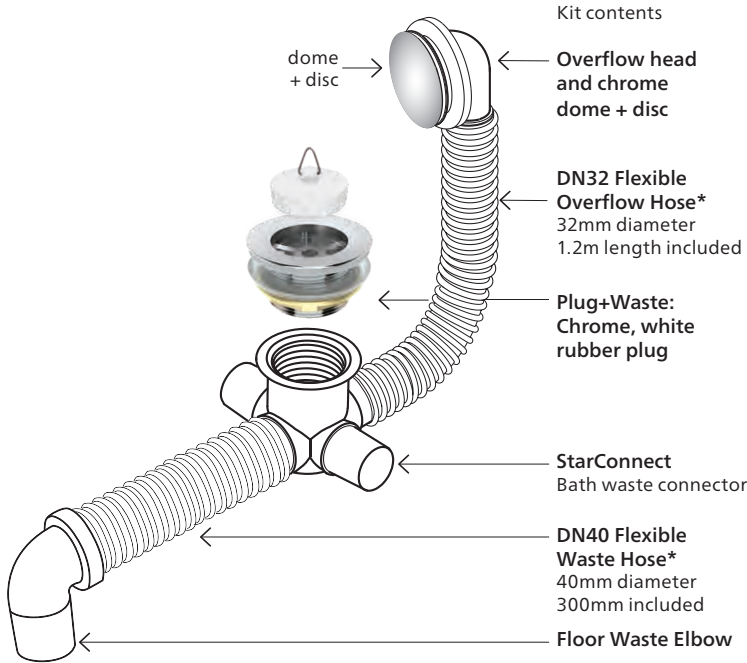

\* Longer hose lengths available separately.

### FlexiWaste basic bath overflow kit

#### Kit includes

- Plug+Waste, chrome, white rubber plug
- Overflow dome, chrome
- Overflow kit

FlexiWaste offers a universal ultra-compact bath waste solution. The innovative StarConnect bath waste connector has an ultra-low 75mm profile under the bath, and multi-directional input and outlet options.

#### Order code

192180 FlexiWaste Bath OF Kit – Basic, with Plug+Waste, chrome/white rubber

#### Optional extra hose – Spare parts

192175 DN40 Flexible waste hose, 300mm long  
 192209 DN40 Flexible waste hose, 500mm long  
 192210 DN40 Flexible waste hose, 1.0m long  
 192176 DN32 Flexible overflow hose, 1.2m long  
 192208 DN32 Flexible overflow hose, 2.0m long

#### Product details

**MATERIALS** StarConnect connector, floor waste elbow – PVC.  
 Waste – Metal.  
 Flexible hose – Corrugated PVC.  
 Overflow head – Metal (chrome finish), PVC, rubber seal.

**INSTALLATION** Please refer to installation instructions.

**CLEANING** Clean with soapy water. Do not use corrosive or abrasive cleaners.

### The StarConnect advantage

Ultra-compact bath waste connector

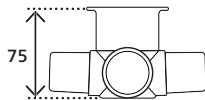

**1** Ultra-low 75mm profile under bath

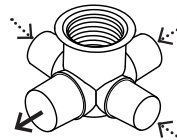

**2** Multi-directional input + outlet options

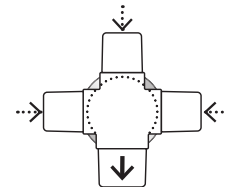

**3** Knock-out openings on all three DN32 spigots



Designed and made in Australia by SEIMA.  
 This SEIMA innovation is a patented, registered design.

# SEIMA

kitchen + laundry + bathroom ware

seima.com.au

#### Please note

- All measurements are in millimetres.
- Use silicone sealant. Do not use epoxy type adhesives.
- Specifications may vary without notice as part of our continuous improvement practices.
- Clean with a damp cloth. Do not use abrasive cleaners, liquids or pastes.

# FlexiWaste Bath Waste Pop-out Kit

## FlexiWaste

Bath Waste Pop-out Kit

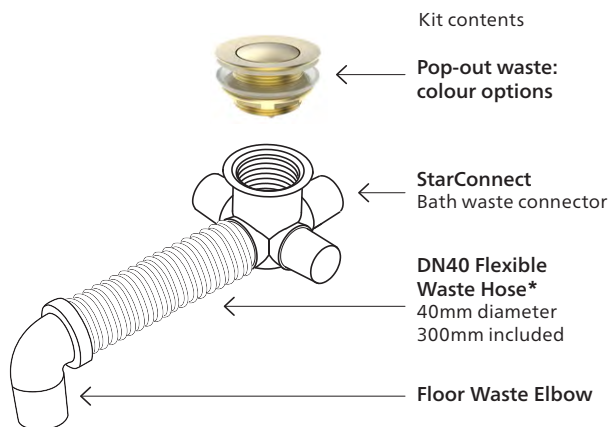

\* Longer hose lengths available separately.

### FlexiWaste premium bath waste kit

- Suits non-overflow baths
- Suits baths with integrated overflow

#### Kit includes

- Premium Pop-out Bath Waste – colour options
- FlexiWaste bath waste kit

FlexiWaste offers a universal ultra-compact bath waste solution. The innovative StarConnect bath waste connector has an ultra-low 75mm profile under the bath, and multi-directional input and outlet options.

Please note: The Pop-out Waste in this kit is suitable for both non-overflow and integrated overflow requirements when used with this kit.

#### Order codes

192329	FlexiWaste Bath Waste Pop-out Kit, Brushed Nickel
192330	FlexiWaste Bath Waste Pop-out Kit, Black Silk Matte
192331	FlexiWaste Bath Waste Pop-out Kit, White Gloss
192458	FlexiWaste Bath Waste Pop-out Kit, White Matte
192332	FlexiWaste Bath Waste Pop-out Kit, Gunmetal
192333	FlexiWaste Bath Waste Pop-out Kit, Brushed Gold
192179	FlexiWaste Bath Waste Pop-out Kit, Chrome

#### Optional extra hose — Spare parts

192175	DN40 Flexible waste hose, 300mm long
192209	DN40 Flexible waste hose, 500mm long
192210	DN40 Flexible waste hose, 1.0m long

#### Product details

**MATERIALS** StarConnect connector, floor waste elbow — PVC.  
Waste — Metal.  
Flexible hose — Corrugated PVC.

**INSTALLATION** Please refer to installation instructions.

**CLEANING** Clean with soapy water. Do not use corrosive or abrasive cleaners.



### The StarConnect advantage

Ultra-compact bath waste connector

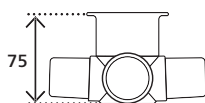

Ultra-low 75mm profile under bath

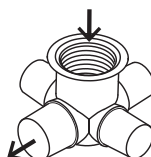

**NOTE** Only the DN40 Spigot is used in this FlexiWaste Bath Kit. (The three DN32 spigots are only needed for FlexiWaste Overflow Kits. Leave the DN32 spigots intact when using this kit.)



Designed and made in Australia by SEIMA.  
This SEIMA innovation is a patented, registered design.

# SEIMA

kitchen + laundry + bathroom ware

seima.com.au

#### Please note

- All measurements are in millimetres.
- Use silicone sealant. Do not use epoxy type adhesives.
- Specifications may vary without notice as part of our continuous improvement practices.
- Clean with a damp cloth. Do not use abrasive cleaners, liquids or pastes.

# FlexiWaste Bath Waste Kit Basic

## FlexiWaste

Bath Waste Kit Basic

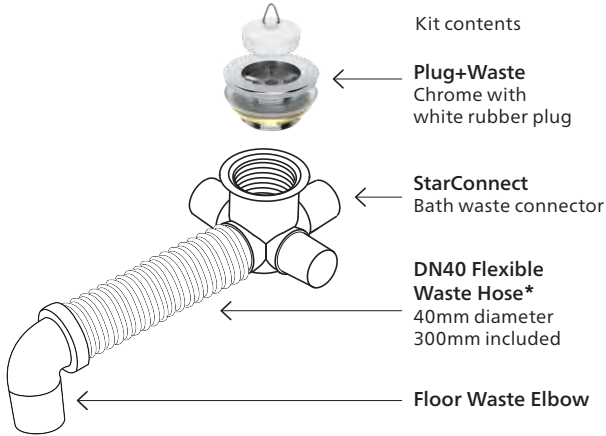

### FlexiWaste basic bath waste kit Suits non-overflow baths

#### Kit includes

- Plug+Waste, chrome, white rubber plug
- FlexiWaste bath waste kit

FlexiWaste offers a universal ultra-compact bath waste solution. The innovative StarConnect bath waste connector has an ultra-low 75mm profile under the bath, and multi-directional input and outlet options.

#### Order code

192178 FlexiWaste Bath Waste Kit Basic

#### Optional extra hose — Spare parts

192175 DN40 Flexible waste hose, 300mm long  
192209 DN40 Flexible waste hose, 500mm long  
192210 DN40 Flexible waste hose, 1.0m long

#### Product details

**MATERIALS** StarConnect connector, floor waste elbow — PVC.  
Waste — Metal.  
Flexible hose — Corrugated PVC.

**INSTALLATION** Please refer to installation instructions.

**CLEANING** Clean with soapy water. Do not use corrosive or abrasive cleaners.

### The StarConnect advantage

Ultra-compact bath waste connector

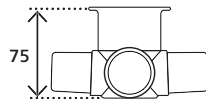

Ultra-low 75mm profile under bath

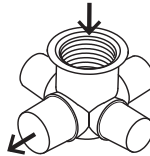

**NOTE** Only the DN40 Spigot is used in this FlexiWaste Bath Kit. (The three DN32 spigots are only needed for FlexiWaste Overflow Kits. Leave the DN32 spigots intact when using this kit.)



Designed and made in Australia by SEIMA.  
This SEIMA innovation is a patented, registered design.

# SEIMA

kitchen + laundry + bathroom ware

seima.com.au

#### Please note

- All measurements are in millimetres.
- Use silicone sealant. Do not use epoxy type adhesives.
- Specifications may vary without notice as part of our continuous improvement practices.
- Clean with a damp cloth. Do not use abrasive cleaners, liquids or pastes.