

WINSLOW BASIN MIXER WITH METAL LEVER

1.8104.00.3.XX



PRODUCT DIMENSIONS:

Front view:

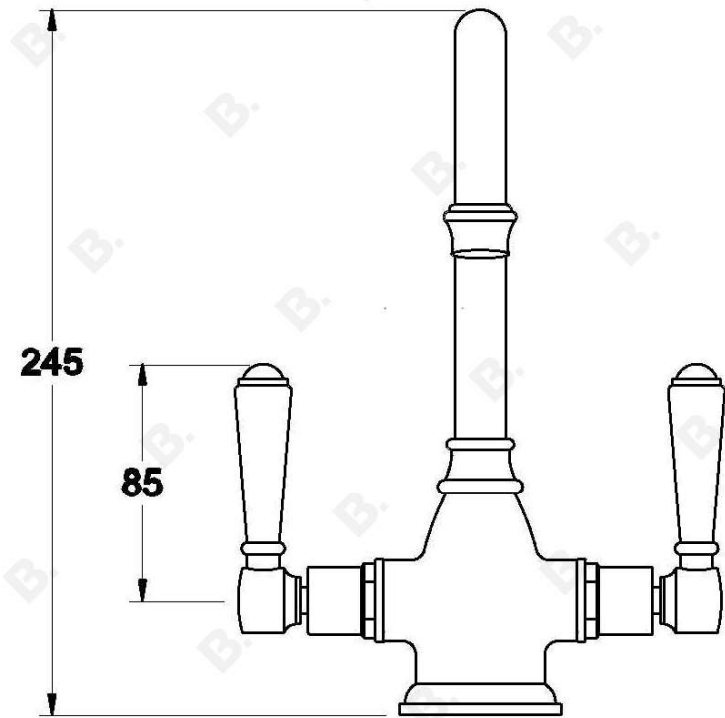

Side view:

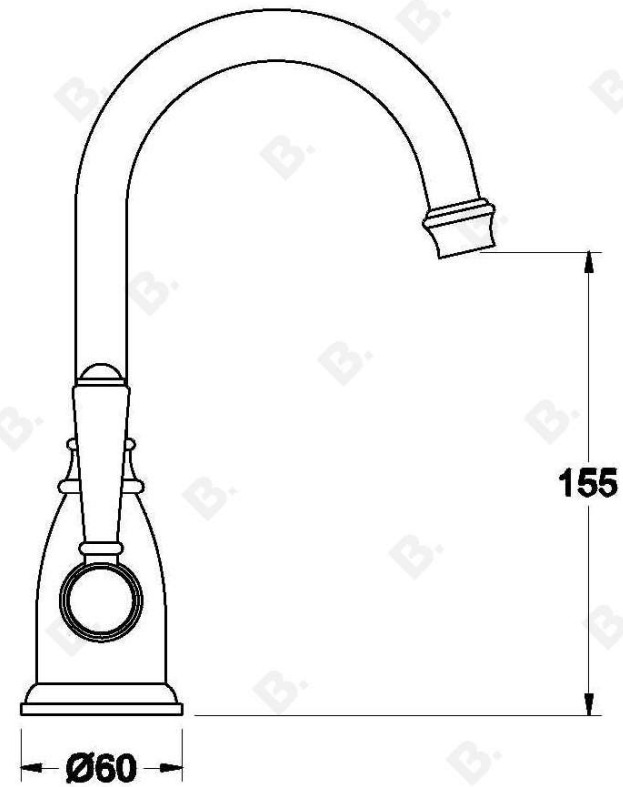

Top view:

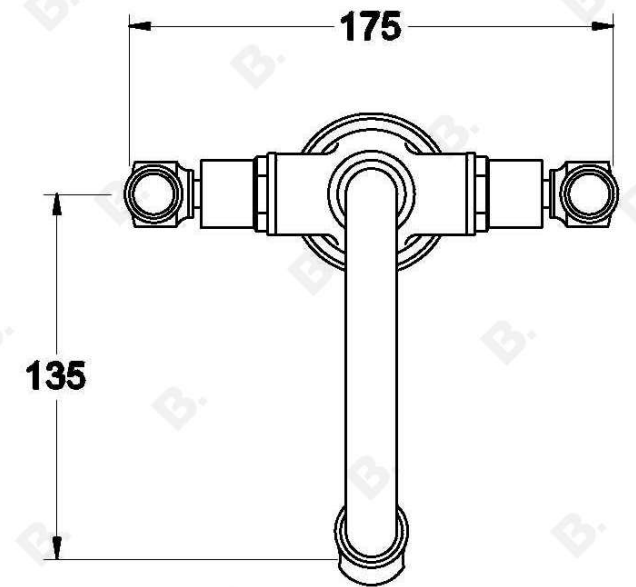

Note: Mixer requires a Ø35mm hole in the basin or bench