

BioLite BaseLantern | BaseLantern XL

IMPORTANT: Read all instructions and warnings before use.

WARNING: BaseLantern contains batteries. Keep away from heat. Store in cool dry area when not in use.

Care & Maintenance: If BaseLantern gets dirty, wipe down with damp towel. The BaseLantern is weather resistant, but not waterproof: do not leave out in rain for prolonged period of time and do not submerge in water.

Product Specifications:
Water Resistant: IPX4
Dimensions: 5.1 x 5.0 x 1.7 in (12.95 x 12.7 x 4.32 cm)
Weight: 1.30 lbs (590g) / 1.41 lbs (639g) XL
Inputs: Micro USB charge in
Outputs: USB charge out x2, SiteLight port x2
Burn Time: 54 LO, 5 HI / 78 LO, 7.5 HI XL
Lumens: 500 Lm
Battery: 7800 / 12000 XL mAh lithium-ion

In The Box: BaseLantern / BaseLantern XL, Micro USB cord, Quick Start Guide.

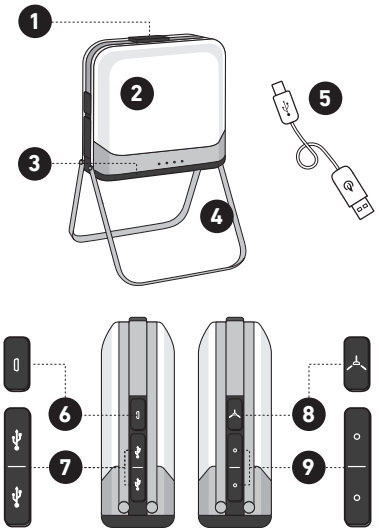

Prior to First Use: DISABLE DEMO MODE.

To disable Demo Mode, hold the power button for 10 seconds until the lantern blinks twice. Alternatively, you may also disable Demo Mode by plugging the BaseLantern into any USB power source.

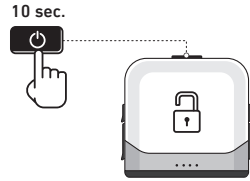

Components & Controls

- | | |
|---|-----------------------------|
| 1. Power Button | 5. Micro USB Cord |
| 2. Lantern Light | 6. Micro USB Charge In Port |
| 3. 7800 / 12000 (XL) mAh Rechargeable Battery | 7. USB Charge Out Ports x2 |
| 4. Folding Legs | 8. SiteLight Control Button |
| | 9. SiteLight Ports x2 |

1 SETUP

- Prior to first use, charge up your BaseLantern via Micro USB. The LED battery life indicator will blink left-to-right to show BaseLantern is charging and the 4 LEDs will turn solid when the battery is full (approx. 5 hours / 8 hours XL).
- BaseLantern features stainless steel folding legs that raise your lantern and create a wider perimeter of light (1.1). You can also utilize the legs for angled task-lighting (1.2) or hanging the lantern like a lightbulb (1.3).

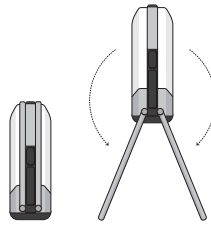

1.1

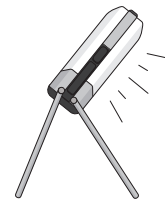

1.2

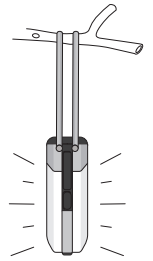

1.3

2 LIGHTING

BaseLantern has 3 lighting modes that are accessible through manual operation. To engage additional lighting functionality, please download the BioLite BaseLantern Mobile App (See Section 5) and follow setup instructions.

BaseLantern Manual Settings

To change lighting modes, press power button in quick succession (1 second) until you have reached desired setting.

Press

1X
White Lantern

1X
Activate Charging

Press & Hold
To Dim White Lantern

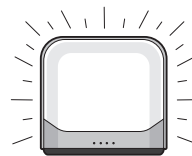

2X
Single Panel

Press & Hold
To Dim White Lantern

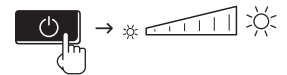
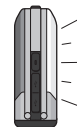

3X
Red Night Mode

Press & Hold
To activate full Color Spectrum control

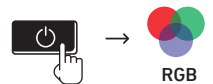
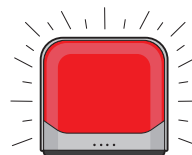

USAGE TIPS:

- When turning on, BaseLantern's memory returns to its last used lighting function. Simply press power button in quick succession to reach desired setting.
- LOCK MODE:** To avoid accidental activation of BaseLantern in transit, hold the power button for 3 seconds while it is OFF. Lantern will flash, indicating it is in lock mode. When you want to unlock it, hold again for 3 seconds. It will flash once to indicate it is out of Lock Mode.



3 BASELANTERN + SITELIGHTS

Note: BioLite SiteLights are sold separately from BaseLantern

To expand your outdoor lighting system with overhead lights, connect BioLite daisy-chainable SiteLights to your BaseLantern which features 2 SiteLite ports, allowing you set up string lighting in two directions at once:

1. Uncouple SiteLights and extend SiteLight cord to desired length. (3.1)
2. Plug SiteLight into BaseLantern SiteLight Port. (3.2)
3. Daisy-chain desired network of SiteLights together by plugging subsequent SiteLight jacks into preceding SiteLight port. (3.3)
4. To turn on and dim SiteLights manually, press SiteLight button located next to SiteLight Ports on BaseLantern. (3.4) You may control each SiteLight individually via their manual buttons located on top of each light. (3.5)
5. To turn on and dim SiteLights remotely, please refer to the BaseLantern mobile app.

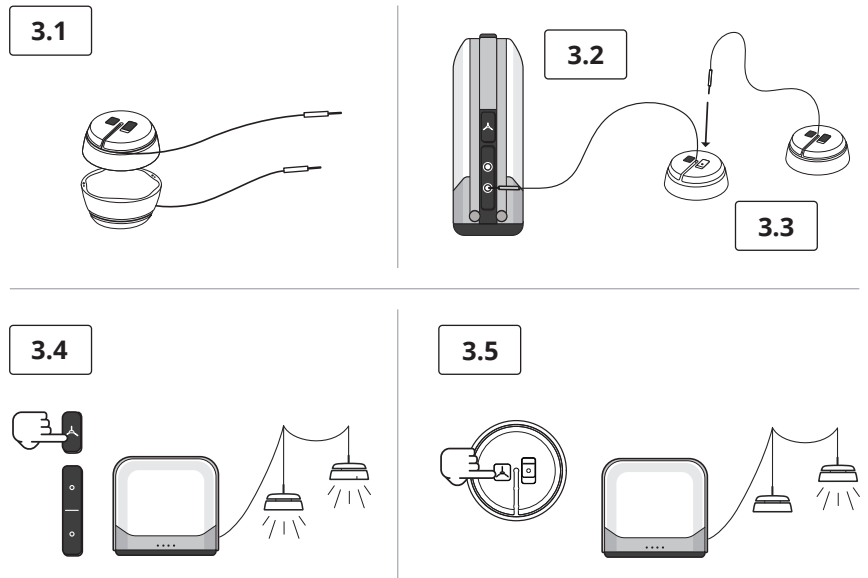

4 CHARGING

Charge Out

BaseLantern's internal li-ion battery may be used for both lighting and external charging to other devices via USB.

1. To charge devices, plug charging cord into USB charge-out port located on side of BaseLantern. (4.1)
2. If BaseLantern is in OFF setting, press power button once to activate charging. (4.2) You may then turn light panels off to conserve battery while keeping devices charging.
3. BaseLantern features [2] USB charge-out ports allowing you to charge two devices at once. Note: When charging two devices, one port will charge at 2.1A while the second will charge at 1A.

Charge In

There are 4 LED lights on the side of your BaseLantern to represent the power reserves of the internal battery. When your battery is below 10% the first LED on the left will begin flashing; your BaseLantern will enter **Low Power Mode** and will stop offering charge-out to external devices.

1. Plug the included micro-USB cord into BaseLantern input port. (4.3)
2. Connect to USB power source such as wall or car charger. (4.4)
3. LED battery indicator lights will flash sequentially from left to right to indicate battery is charging. (4.5)
4. When battery is fully charged, all 4 LEDs will be lit.

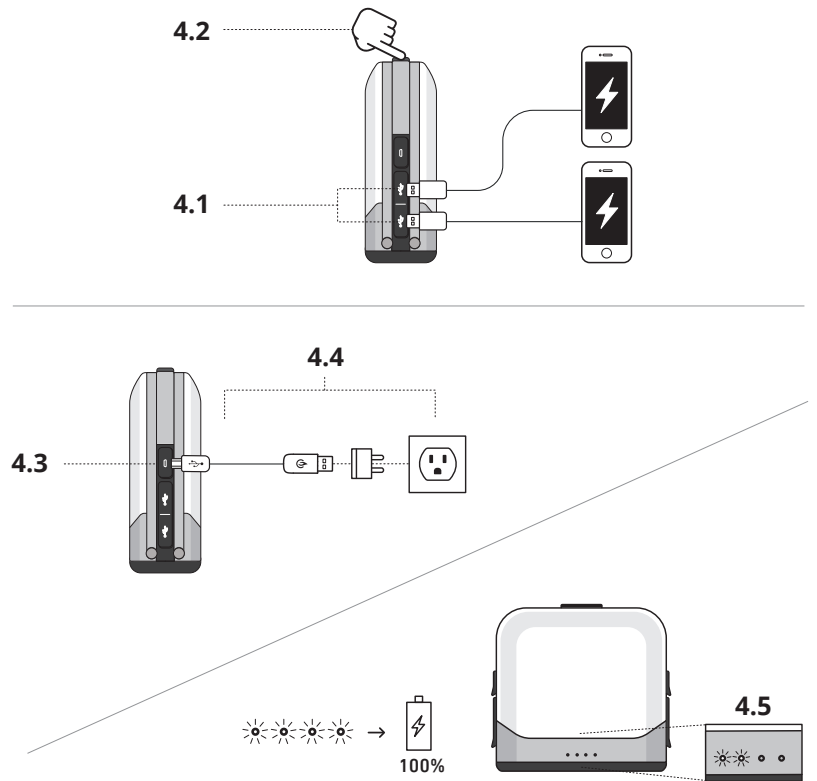

5 BIOLITE BASELANTERN MOBILE APP

The BaseLantern features a free mobile app for iOS and Android. This app enables you to activate sleep timers, proximity activation, color settings, battery life feedback, remote dimming and several other functions all from your smartphone.

Download at: [BioliteEnergy.com/baselantern-app](https://www.BioliteEnergy.com/baselantern-app)

Or visit the Apple or GooglePlay app store and search "BioLite".

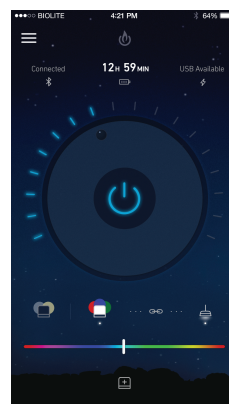

- Full Color & Warmth Control
- Automatic On/Off When In Range
- Real Time Power Usage Stats
- Lantern Effects
- Turn On, Off & Dim
- Alarm & Timers

TROUBLESHOOTING

Problem	Solution
BaseLantern cycles through lighting modes then shuts off.	BaseLantern is in DEMO MODE. To deactivate, hold power button down on BaseLantern for 10 seconds until BaseLantern blinks twice.
BaseLantern blinks twice but will not turn on.	BaseLantern is in LOCK MODE. This is designed to prevent your light from accidentally turning on while in transit. To unlock, hold power button down for 5 seconds until BaseLantern blinks twice.
BaseLantern color mode not on the color I want and I want to control it manually.	Press and hold to cycle through colors and reach desired color.
BaseLantern not responding to Mobile App commands.	Check to ensure bluetooth settings are on and that BaseLantern has been paired with your phone. Check top left corner of mobile app to verify that system is connected.
SiteLights are not working.	Ensure that all SiteLights are firmly plugged into ports (often requires an extra push) and individual SiteLites are all in manual ON position in order to be controlled from mobile App.

For videos, FAQs, and more please visit [BioLiteEnergy.com/Instructions](https://www.BioLiteEnergy.com/Instructions)

WARRANTY

BioLite has a 1 year limited warranty. Should this product not function properly under normal use within 1 year of purchase, contact BioLite or your local distributor for return process information. BioLite alone will determine if the problem is due to a manufacturing flaw. If so, BioLite will repair or replace the unit at its discretion and send it to you, free of charge. This warranty does not cover any damage or malfunction arising from misuse, improper maintenance, negligence, normal wear and tear, or accident. Never alter the BaseLantern in any way or use with any part or accessory not expressly approved by BioLite. This warranty applies only to the original purchaser and proof of purchase is required. All implied warranties required under law are limited to one year. BioLite shall not be liable for any consequential or incidental damages whatsoever. BioLite shall not be held liable if the product or defect herein causes damage or failure of other equipment. This warranty gives you specific legal rights. You may also have other rights that vary from state to state. Some states do not allow the exclusion or limitation of incidental or consequential damages, or limitation or exclusion of implied warranties, so the above exclusions or limitations may not apply to you.

This device complies with part 15 of the FCC Rules. Operation is subject to the following two conditions: (1) This device may not cause harmful interference, and (2) this device must accept any interference received, including interference that may cause undesired operation.

EU Compliance Statement - BioLite Inc. hereby declares that this device is in compliance with the essential requirements and other relevant provisions of the R&TTE Directive. A copy of the EU Declaration of Conformity is available online at [bioliteenergy.com/euro-compliance](https://www.bioliteenergy.com/euro-compliance). BioLite's EU representative is DSV Solutions Nederland BV, Tradeboulevard 4, Haven 528, 4761 RL Moerdijk, P.O. Box 6086, 4780 LX Moerdijk, The Netherlands.

CALIFORNIA PROPOSITION 65 WARNING: This product contains a chemical known to the State of California to cause cancer and birth defects or other reproductive harm.

IC ID: 4100A-BT600E
FCC ID: X8WBT600E



BioLite SolarPanel 5+

IMPORTANT: Read all instructions and warnings before use.

WARNING: The SolarPanel 5+ contains a battery. Do not submerge in water.

Prior to First Use: The SolarPanel 5+ comes with an integrated battery, allowing you to store power on the go. For a head start on the trail, you can pre-charge your SolarPanel 5+ before heading out by plugging it in via micro-USB to any power source such as a wall outlet or computer USB port.

In the Box: SolarPanel 5+, USB Cable, Quick Start Guide

Care & Maintenance: If the SolarPanel 5+ gets dirty, simply wipe away the dirt with a damp cloth. The SolarPanel 5+ is weather resistant. Do not leave out in rain for prolonged period of time and do not submerge in water. Store in a cool dry area when not in use.

Product Specifications: Dimensions: 10.12 x 8.19 x 0.94 in; 257 x 208 x 24 mm **Weight:** 13.76 oz/390g **Inputs:** Micro USB charge in **Outputs:** USB charge out **Power Output:** 5 watts at peak sun **Cell Type:** Monocrystalline **Battery:** 2200 mAh lithium-ion, 8 Wh storage

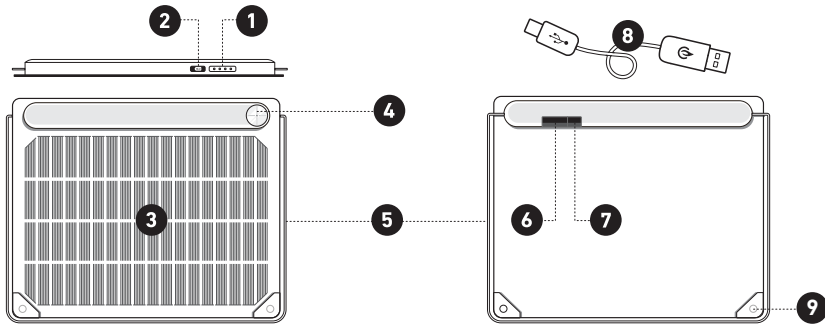

Components & Controls

- | | | |
|--|-------------------|------------------------|
| 1. Battery & Charge Strength Indicator | 4. Sundial | 7. Micro USB Charge In |
| 2. Battery Status Button | 5. Kickstand | 8. USB Cable |
| 3. High Efficiency Monocrystalline Panel | 6. USB Charge Out | 9. Corner Latches |

1 SETUP

- To maximize power generation, place your SolarPanel 5+ in direct sunlight: align the panel's **sundial** so that the black dot's shadow is in the center of the axis. **(1.1)**
- Stabilize the position of your panel with the integrated 360 degree kickstand: rotate in any direction for hanging, standing, or stabilizing on uneven terrain. **(1.2)**

2 CHARGING

- The SolarPanel 5+ provides **5 watts** of usable electricity and can safely charge devices via USB such as phones, headlamps, lanterns, and the BioLite CookStove.
- The **Battery & Charge Strength indicator (2.1)** is represented by 4 LED lights. When all 4 LED lights are flashing you are generating maximum power from the sun.

Reference tip: 2 hours in direct peak sun will fully charge most smartphones. We recommend closing apps and wi-fi to conserve your power.

- The SolarPanel 5+ features an on-board 2200 mAh battery, enabling you to charge your devices either in real time or store your power for when you need it. Press the **battery status (2.2)** button and the LED lights will temporarily turn solid to display the fullness of the battery: if all 4 LEDs are solidly lit, your battery is fully charged.

Reference tip: Approximately 2 hours in direct peak sun will fully charge the integrated battery

- To charge a device using the SolarPanel 5+, plug the device into the **USB charge out port** located in the orange bar on the backside of your panel **(2.3)** and press the power button once.
- To stop charging your device, unplug from the SolarPanel 5+.
- To supplement or top off your SolarPanel 5+'s internal battery, use the included micro USB cord to connect to a wall outlet, computer, or other USB power source. **(2.4)**

Note: The SolarPanel 5+ will not charge devices via the micro-USB panel (2.4) - this input is for charging the internal battery only.

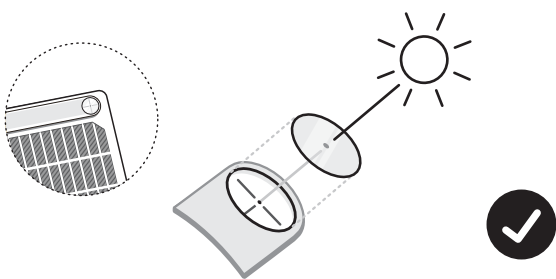

1.1

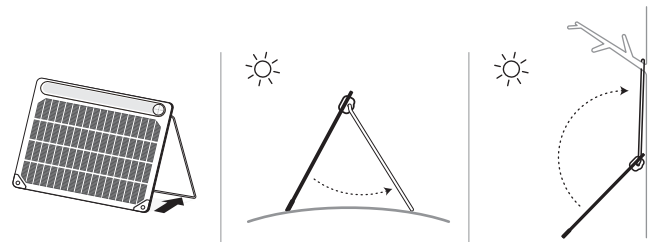

1.2

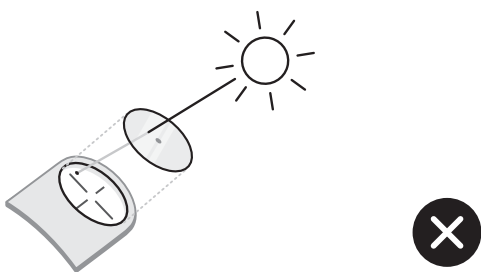

2.1

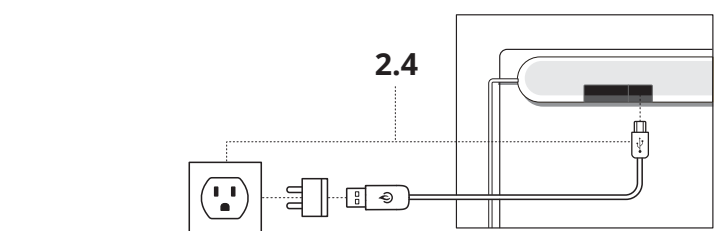
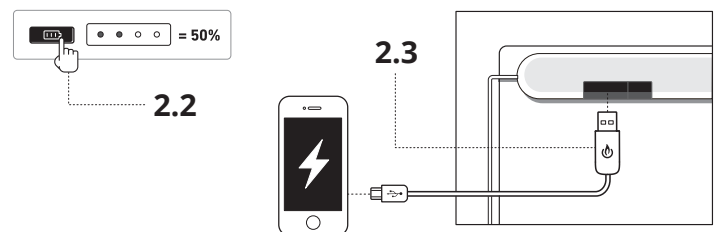
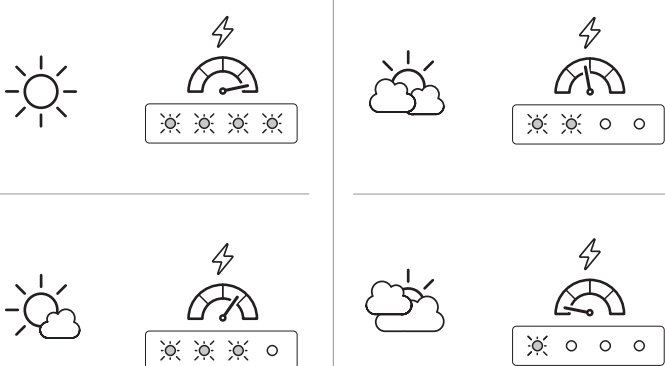
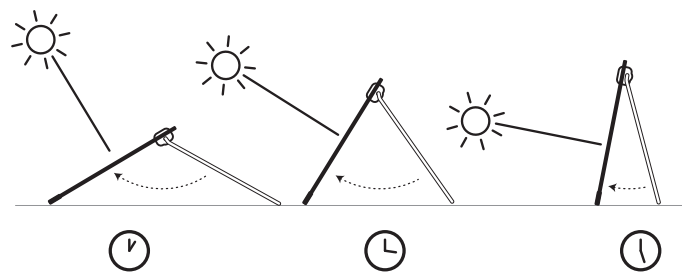

WARRANTY

BioLite has a 1-year limited warranty. Should this product not function properly under normal use within 1 year of purchase, contact BioLite or your local distributor for return process information. BioLite alone will determine if the problem is due to a manufacturing flaw. If so, BioLite will repair or replace the unit at its discretion and send it to you, free of charge. This warranty does not cover any damage or malfunction arising from misuse, improper maintenance, negligence, normal wear and tear, or accident. Never alter the SolarPanel 5+ in any way or use with any part or accessory not expressly approved by BioLite. This warranty applies only to the original purchaser and proof of purchase is required. All implied warranties required under law are limited to one year. BioLite shall not be liable for any consequential or incidental damages whatsoever. BioLite shall not be held liable if the product or defect herein causes damage or failure of other equipment. This warranty gives you specific legal rights. You may also have other rights that vary from state to state. Some states do not allow the exclusion or limitation of incidental or consequential damages, or limitation or exclusion of implied warranties, so the above exclusions or limitations may not apply to you.