

Orimba Bookcase - L1

Product Specifications



Designed For:
Penguin Paperbacks
Small Ceramics
Scale Models

Designed For:
Hardcover Novels
Potted Plants
Framed Photos

Designed For:
Large Vases
Atlases

Designed For:
Coffee Table Books
Ring Binders

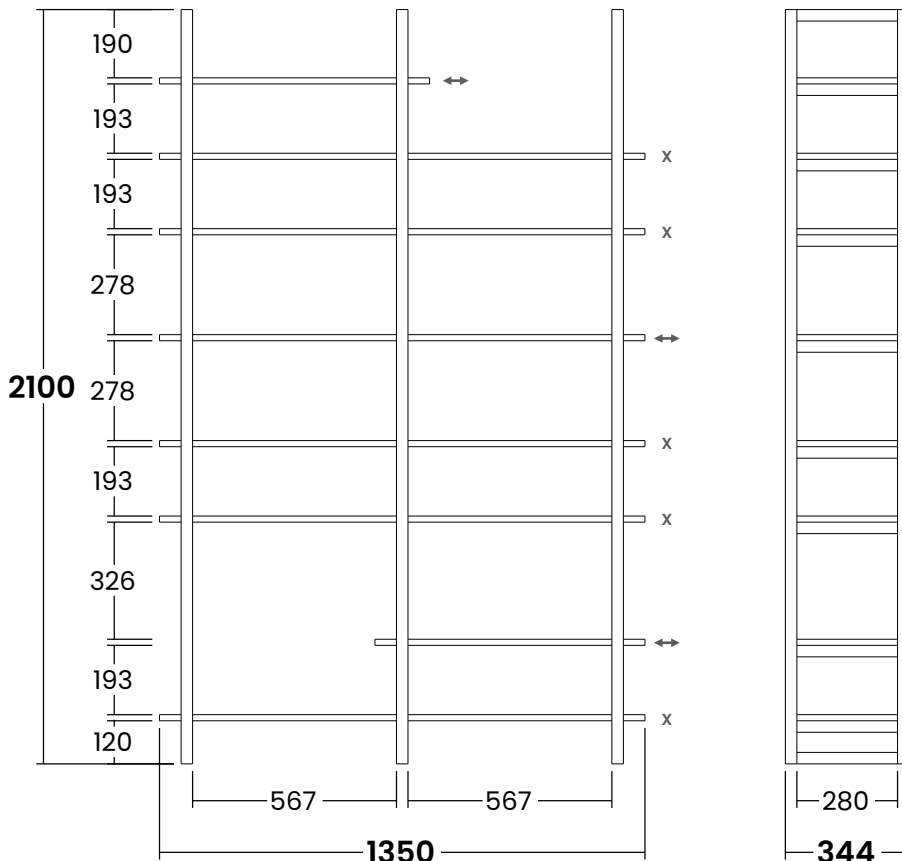

Orimba Bookcase Versions

Orimba Bookcase - L2

Product Specifications



Designed For:
 Penguin Paperbacks
 Small Ceramics
 Scale Models

Designed For:
 Hardcover Novels
 Potted Plants
 Framed Photos

Designed For:
 Large Vases
 Atlases

Designed For:
 Coffee Table Books
 Ring Binders

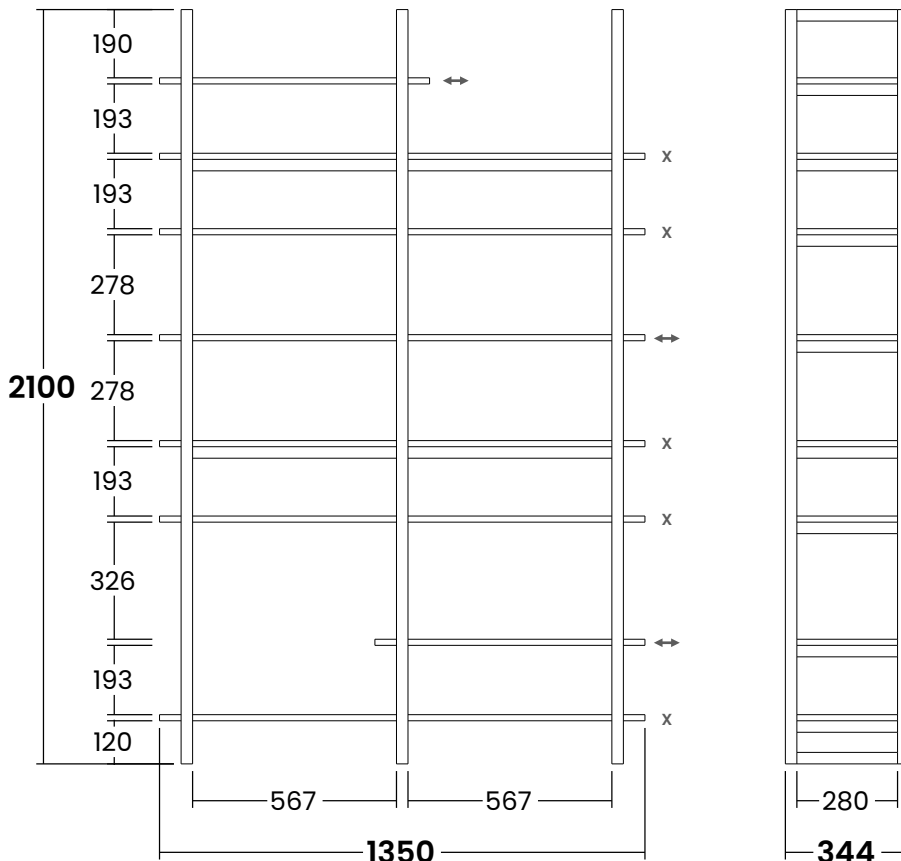

X = Fixed Shelves ↔ = Interchangeable Shelves



Orimba Bookcase Versions

Orimba Bookcase - L3

Product Specifications



Designed For:
 Penguin Paperbacks
 Small Ceramics
 Scale Models

Designed For:
 Hardcover Novels
 Potted Plants
 Framed Photos

Drawer Internal Size:
 505 x 240 x 120mm

Designed For:
 Coffee Table Books
 Ring Binders

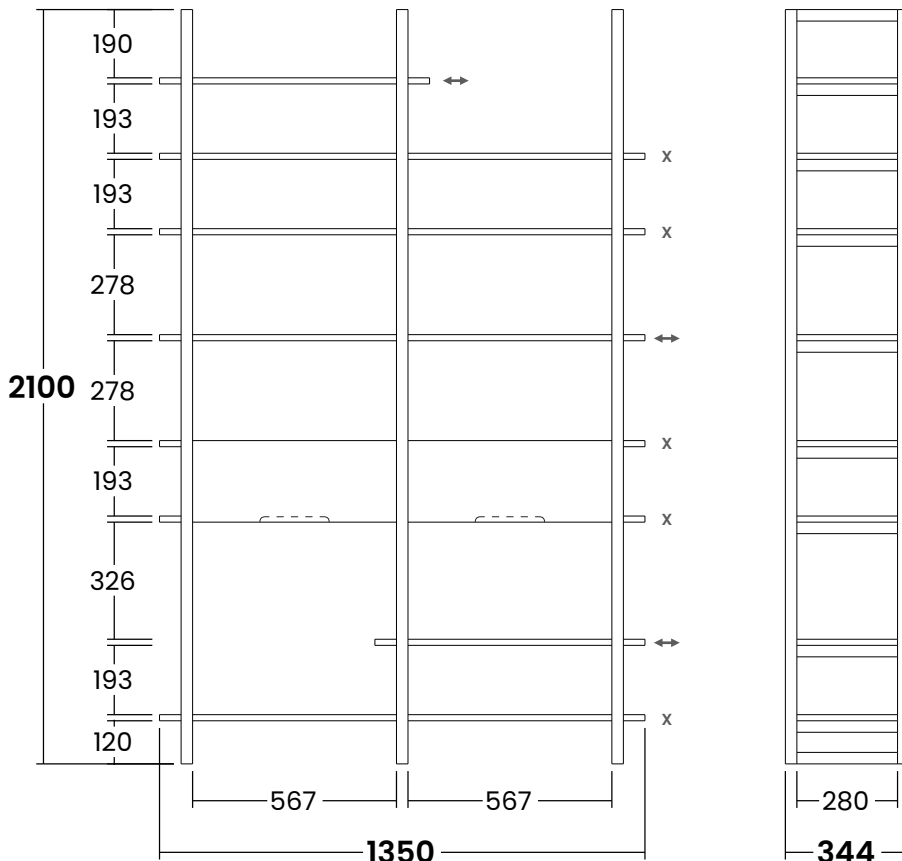

x = Fixed Shelves ↔ = Interchangeable Shelves



Orimba Bookcase Versions

Orimba Bookcase - L4

Product Specifications



Designed For:
 Penguin Paperbacks
 Small Ceramics
 Scale Models

Designed For:
 Hardcover Novels
 Potted Plants
 Framed Photos

Designed For:
 Large Vases
 Atlases

Designed For:
 A4 Documents
 Crockery

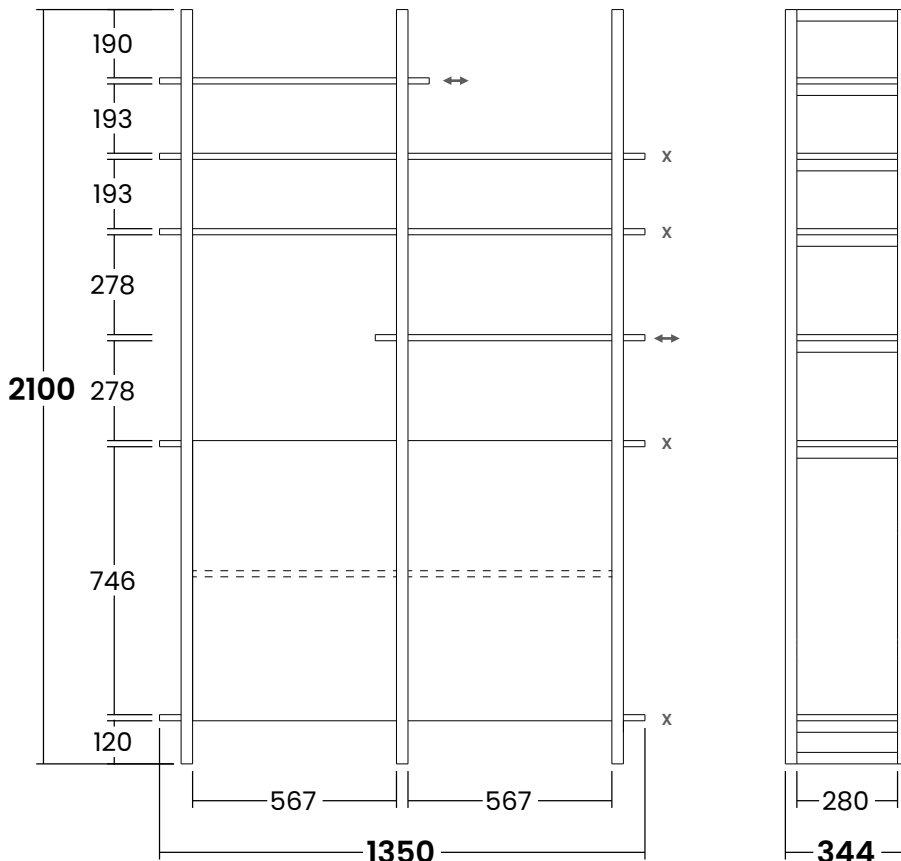

Orimba Bookcase Versions

x = Fixed Shelves ↔ = Interchangeable Shelves

Orimba Bookcase - S1

Product Specifications



Designed For:
Penguin Paperbacks
Small Ceramics
Scale Models

Designed For:
Hardcover Novels
Potted Plants
Framed Photos

Designed For:
Coffee Table Books
Ring Binders

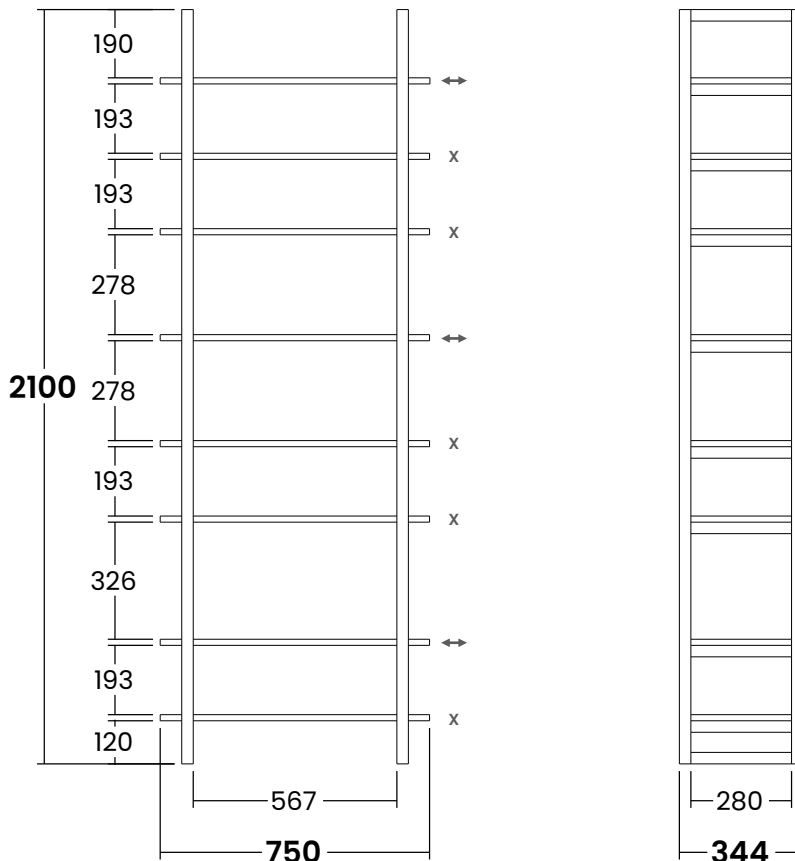

Orimba Bookcase Versions

Orimba Bookcase - S2

Product Specifications



Designed For:
 Penguin Paperbacks
 Small Ceramics
 Scale Models

Designed For:
 Hardcover Novels
 Potted Plants
 Framed Photos

Designed For:
 Coffee Table Books
 Ring Binders

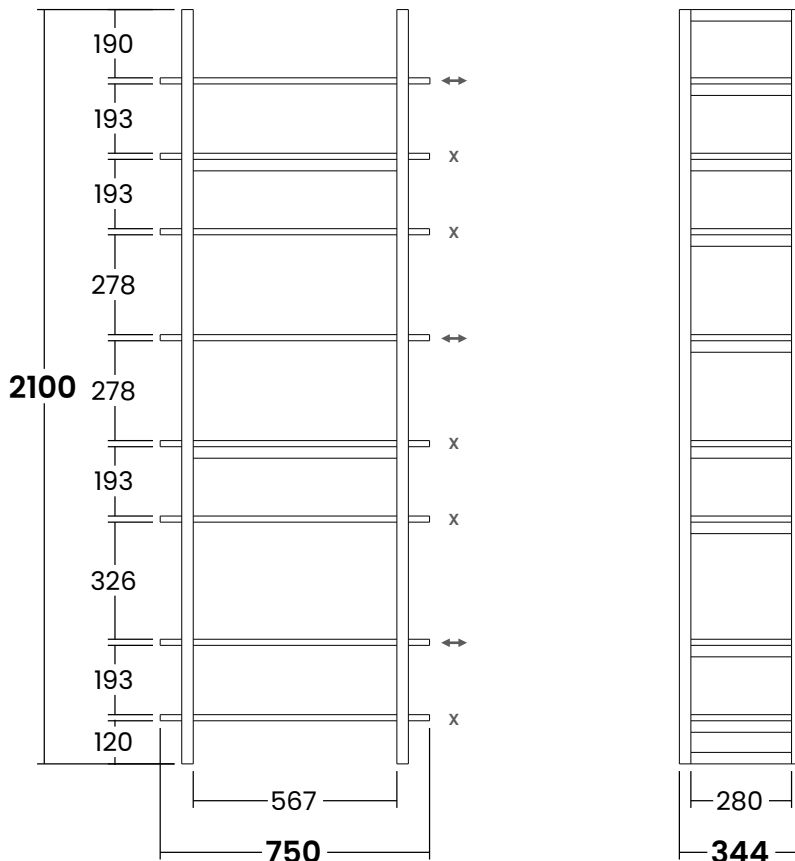

x = Fixed Shelves ↔ = Interchangeable Shelves



Orimba Bookcase Versions

Orimba Bookcase - S3

Product Specifications



Designed For:
Penguin Paperbacks
Small Ceramics
Scale Models

Designed For:
Hardcover Novels
Potted Plants
Framed Photos

Drawer Internal Size:
505 x 240 x 120mm

Designed For:
Coffee Table Books
Ring Binders

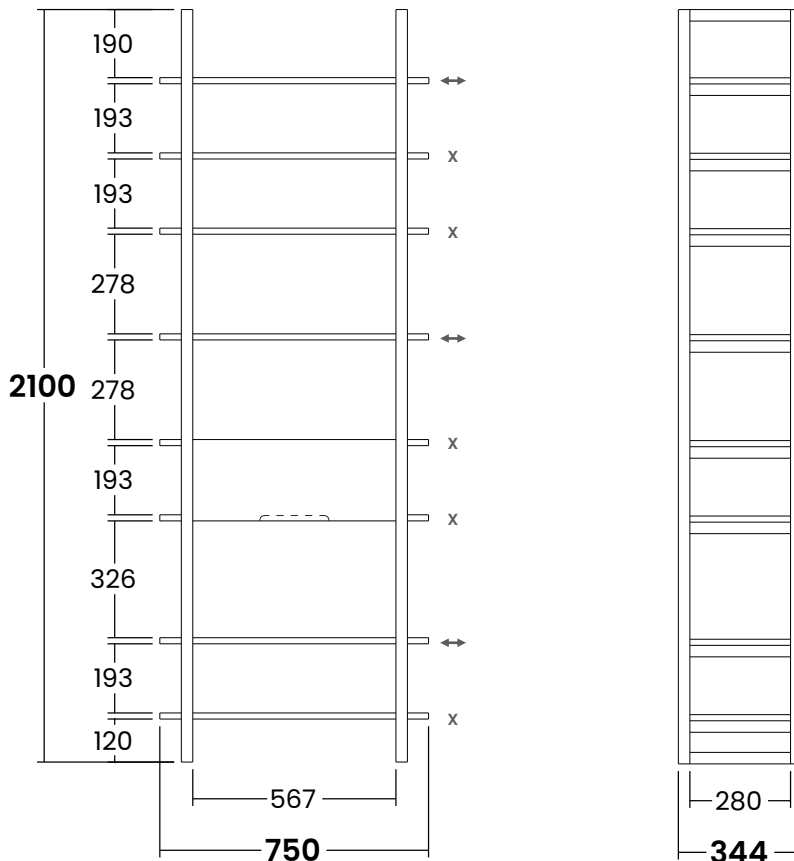

x = Fixed Shelves ↔ = Interchangeable Shelves



Orimba Bookcase Versions

Orimba Bookcase - S4

Product Specifications



Designed For:
 Penguin Paperbacks
 Small Ceramics
 Scale Models

Designed For:
 Hardcover Novels
 Potted Plants
 Framed Photos

Designed For:
 A4 Documents
 Crockery

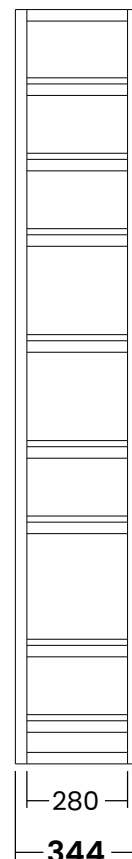
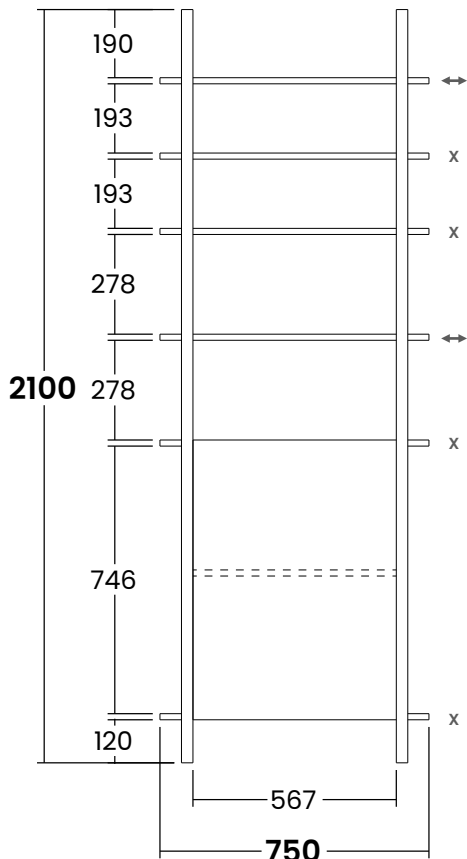

Orimba Bookcase Versions

x = Fixed Shelves ↔ = Interchangeable Shelves

Orimba Bookcase - S1 + S3

Product Specifications



Designed to be fully modular multiple units can be combined easily with the adjustable shelves.
 Shown in render with X1 S1 Orimba Bookcase and X1 S3 Orimba Bookcase.

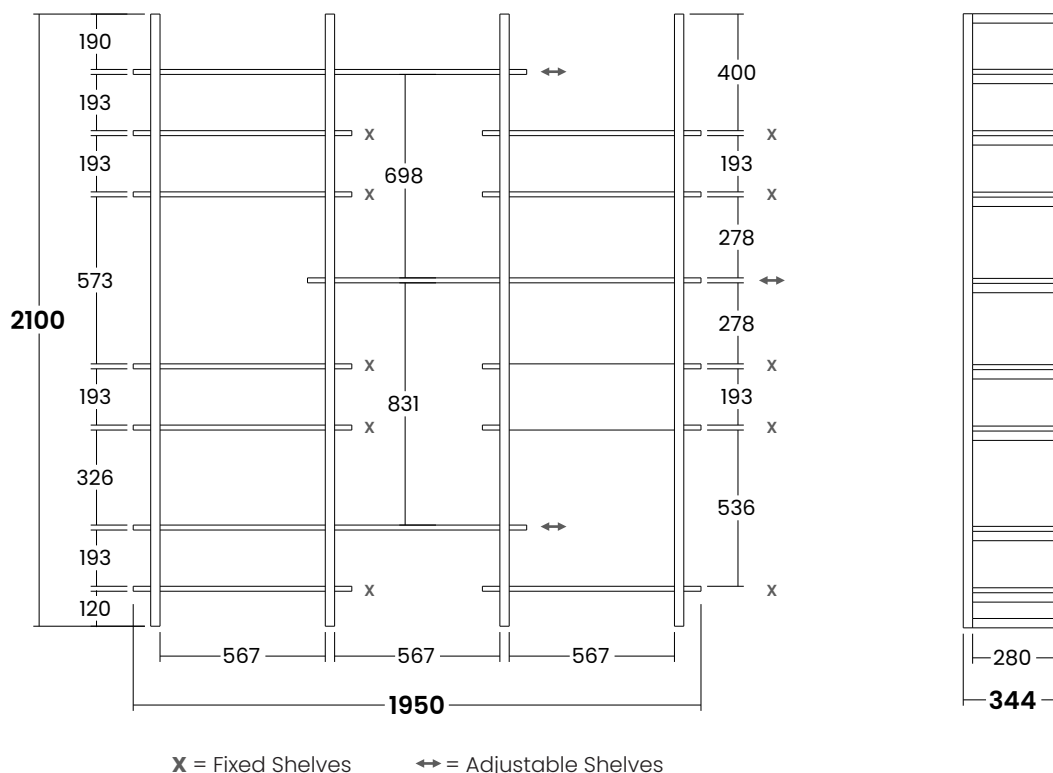

Orimba Bookcase - L1 + S3

Product Specifications



Designed to be fully modular multiple units can be combined easily with the adjustable shelves.
 Shown in render with X1 L1 Orimba Bookcases and X1 S3 Orimba Bookcase.

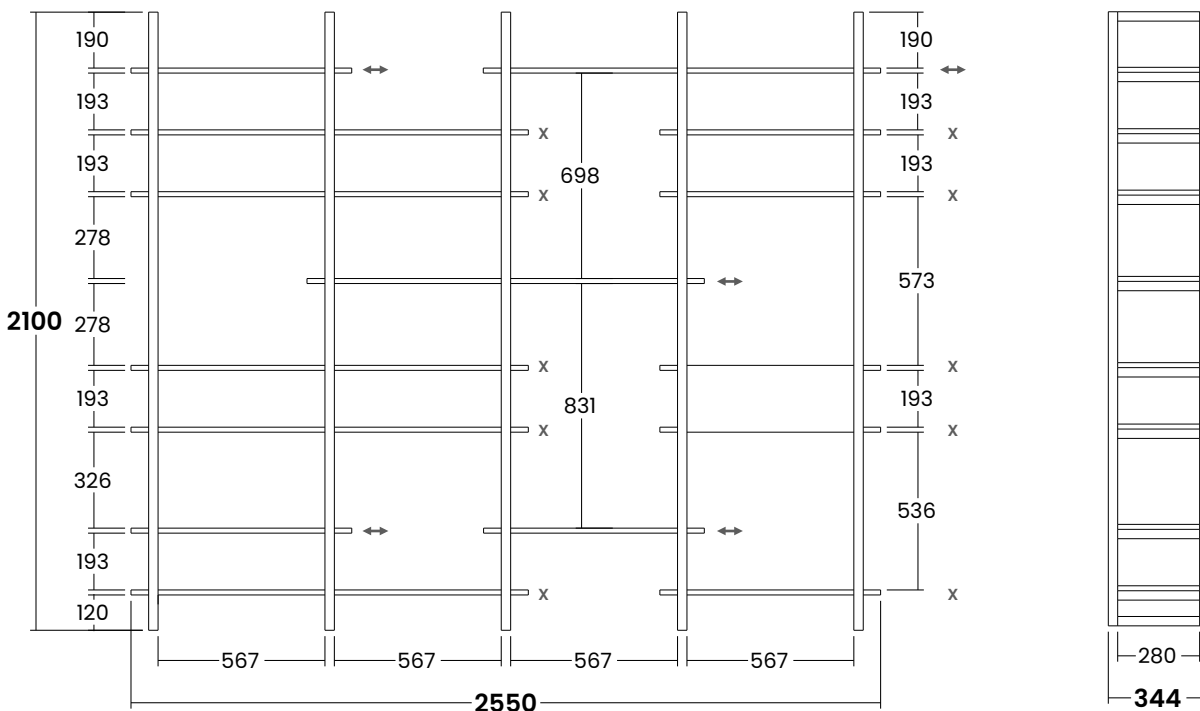

X = Fixed Shelves ↔ = Adjustable Shelves

Orimba Bookcase - L3 + L3

Product Specifications



Designed to be fully modular multiple units can be combined easily with the adjustable shelves.
Shown in render with X2 L3 Orimba Bookcases.

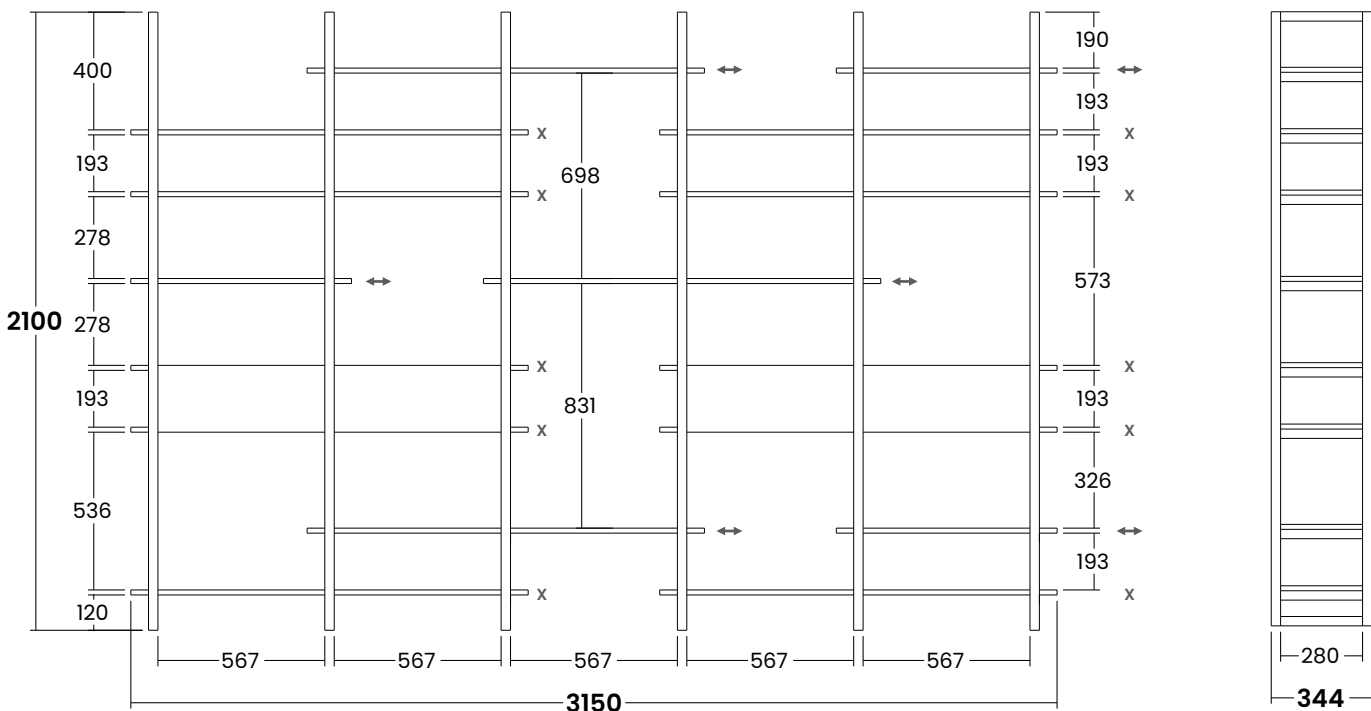

X = Fixed Shelves ↔ = Adjustable Shelves