

Software Guide

ICP DAS LP-8x21 SDK

Implement industry control with Linux Technique

(Version 1.0)

Warranty

All products manufactured by ICP DAS Inc. are warranted against defective materials for a period of one year from the date of delivery to the original purchaser.

Warning

ICP DAS Inc. assume no liability for any damage consequent to the use of this product. ICP DAS Inc. reserves the right to change this manual at any time without notice. The information furnished by ICP DAS Inc. is believed to be accurate and reliable. However, no responsibility is assumed by ICP DAS Co., Ltd. for its use, nor for any infringements of patents or other rights of third parties resulting from its use.

Copyright

Copyright © 2016 by ICP DAS Co., Ltd. All rights are reserved.

Trademarks

Names are used for identification purposes only and maybe registered trademarks of their respective companies.

License

The user can use, modify and backup this software **on a single machine.**

The user may not reproduce, transfer or distribute this software, or any copy, in whole or in part.

Contents

1. Introduction.....	5
2. Installation of the LP-8x21 SDK	7
2.1 Quick Installation of the LP-8x21 SDK	7
2.1.1 Download/Install LP-8x21 SDK on Linux	7
2.1.2 Download/Install LP-8x21 SDK on Windows.....	10
2.1.3 Integrating LP-8x21 SDK with Code::Blocks IDE	12
2.2 Introduction of the LP-8x21 SDK	15
2.2.1 Introduction to Cygwin.....	16
2.2.2 Introduction to Cross-Compilation	16
2.2.3 Download the LP-8x21 SDK	16
3. The Architecture of LIB8K.A in the LP-8x21	17
4. LP-8x21 System Settings	18
4.1 Using a microSD Card	18
4.1.1 Mounting a microSD Card	19
4.1.2 Unmounting the microSD Card.....	19
4.1.3 Scanning and repairing a microSD Card	20
4.2 Using a USB Storage Device	21
4.2.1 Mounting a USB Storage Device	21
4.2.2 Unmounting the USB Storage Device.....	21
4.3 WDT	22
5. Instructions for the LP-8x21	23
5.1 Basic Linux Instructions	23
5.1.1 ls : lists the file information (Equivalent DOS Command: dir).....	23
5.1.2 cd directory: Changes directory (Equivalent DOS Command: cd).....	23
5.1.3 mkdir: creates a subdirectory (Equivalent DOS Command: md)	23
5.1.4 rmdir: deletes the subdirectory which must be empty (Equivalent DOS Command: rd) 23	
5.1.5 rm: deletes (removes) the file or directory (Equivalent DOS Command: delete)	24
5.1.6 cp: copies one or more files (Equivalent DOS Command: copy)	24
5.1.7 mv: moves or renames a file or directory (Equivalent DOS Command: move)	24
5.1.8 pwd: displays the full path of the current working directory	24
5.1.9 who: displays a list of the users current logged on	24
5.1.10 chmod: changes the access permissions for a file	24
5.1.11 uname: displays the Linux version information	25
5.1.12 ps: displays a list of the currently active procedures.....	25

5.1.13 ftp: transfers a file using the file transfer protocol (FTP).....	25
5.1.14 telnet: establishes a connection to another PC via Telnet terminal.....	25
5.1.15 date: prints or sets the system date and time.....	25
5.1.16 hwclock: queries and sets the hardware clock (RTC).....	25
5.1.17 netstat: displays the current state of the network.....	25
5.1.18 ifconfig: displays the ip and network mask information (Equivalent DOS Command: ipconfig).....	25
5.1.19 ping: used to test whether the host in a network is reachable.....	25
5.1.20 clear: clears the screen.....	26
5.1.21 passwd: used to change the password.....	26
5.1.22 reboot: reboots the LinPAC (or use 'shutdown -r now').....	26
5.2 General GCC Instructions.....	26
5.2.1 Compile without linking to the LP-8x21 library.....	27
5.2.2 Compile by linking to the LP-8x21 library (libi8k.a).....	27
5.3 A Simple Example – Helloworld.c.....	29
5.4 i-Talk Utility.....	34
6. LIBI8K.A.....	36
6.1 System Information Functions.....	37
6.2 Digital Input/Output Functions.....	61
6.2.1 For I-8000 modules via parallel port.....	61
6.2.2 For I-7000/I-8000/I-87000 modules via serial port.....	78
6.3 Analog Input Functions.....	118
6.3.1 For I-8000 modules via parallel port.....	118
6.3.2 For I-7000/I-8000/I-87000 modules via serial port.....	134
6.4 Analog Output Functions.....	160
6.4.1 For I-8000 modules via parallel port.....	160
6.4.2 For I-7000/I-8000/I-87000 modules via serial port.....	165
6.5 Error Code Explanation.....	195
6.6 3-axis Encoder Functions.....	196
6.7 2-axis Stepper/Servo Functions.....	204
7. Demos for LP-8x21 Modules With C Language.....	236
7.1 DIO Control Demo for I-7k Modules.....	236
7.2 AIO Control Demo for I-7k Modules.....	241
7.3 DIO Control Demo for I-87KW Modules.....	243
7.3.1 I-87KW Modules in slots of LP-8x21.....	244
7.3.2 I-87KW Modules in slots on I-87KW I/O expansion unit.....	245
7.3.3 I-87KW Modules in slots on I-8000 Controller.....	247
7.4 AIO Control Demo for I-87KW Modules.....	248
7.4.1 I-87KW Modules in slots on an LP-8x21.....	248

7.4.2 I-87KW Modules in slots on an I-87KW I/O expansion unit	250
7.4.3 I-87KW Modules in slots on an I-8000 Controller	252
7.5 DIO Control Demo for I-8KW Modules	252
7.5.1 I-8KW Modules in slots on an LP-8x21	252
7.5.2 I-8KW Modules in slots on an I-8000 Controller	253
7.6 AIO Control Demo for I-8KW Modules	255
7.6.1 I-8KW Modules in the slots on an LP-8x21	256
7.6.2 I-8KW Modules in slots on an I-8000 Controller	258
7.7 Overview of the Module Control Demo Program	260
8. Overview of the Serial Ports on the LP-8x21.....	262
8.1 /dev/ttyO4 Port (COM1)	263
8.2 /dev/ttyS1 OR /dev/ttyS34 Port (COM3 or COM36)	264
8.3 /dev/ttyS0 OR /dev/ttyS1 Port (COM2 or COM3)	265
9. Additional Support	266
9.1 Support for N-Port Modules (I-8114W, I-8112iW, etc.)	266
Appendix A. Service Information	271
Appendix B. Redundant Power	272

1. Introduction

LP-8x21 is the new generation Linux-based PAC (Programmable Automation Controller) from ICP DAS and is equipped with a Cortex-A8 CPU (1.0 GHz) running a Linux kernel 3.x operation system, multiple communication interfaces (VGA, USB, Ethernet and RS-232/485) and 1/4/8 slots for high performance parallel I/O modules (high profile I-8K series) and serial I/O modules (high profile I-87K series).

Main advantage of the LP-8x21 is its high quality control system, including its stably properties, open source and the standard LinPAC SDK for Windows and Linux using the GNU C language, JAVA and GUI software. The main purpose of LP-8x21 is to allow the numerous enthusiastic Linux users to control their own embedded system easily within the Linux environment.

ICP DAS also provides a library file, libi8k.a, which includes all the functions from I-7000/8000/87000 series modules used in the LP-8x21 Embedded Controller. The library is specifically designed for I-7000/8000/87000 series modules based on the Linux platform for use with the LP-8x21 controller. Custom applications can easily be develop for the LP-8x21 using either C or Java, and.NET applications will also be supported in the future. The various functions contained in the library are divided into sub-group functions for ease of use within the different applications.

The powerful features of the embedded controller are depicted below, including a **VGA port**, **USB ports for Card Readers, Cameras, Mouse, or Keyboard**, etc., a **microSD/microSDHC card slot**, **RS-232/RS-485 serial ports**, an **Ethernet port**, together with **8 I/O slots**.

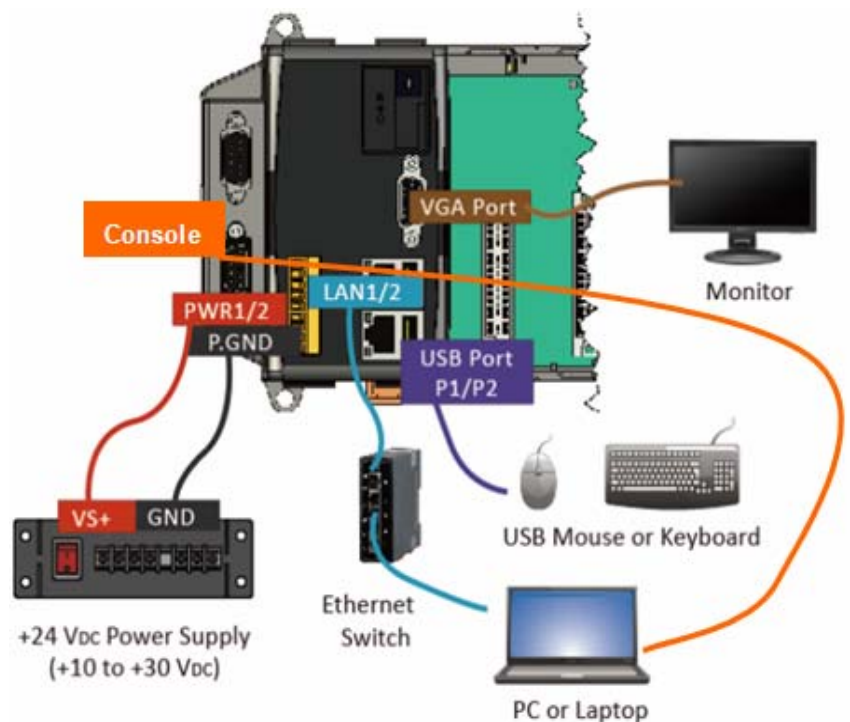

Fig. 1-1

The LP-8x21 controller contains built in HTTP, FTP, Telnet, SSH, and SFTP Servers, meaning that file transfer or remote control is much more convenient with the LP-8x21. For network communication, **wireless, Bluetooth** transfer protocols and **Modem, GPRS, ADSL, Firewall** functions are also supported.

The architecture of the LP-8x21 hardware is illustrated in the figure below.

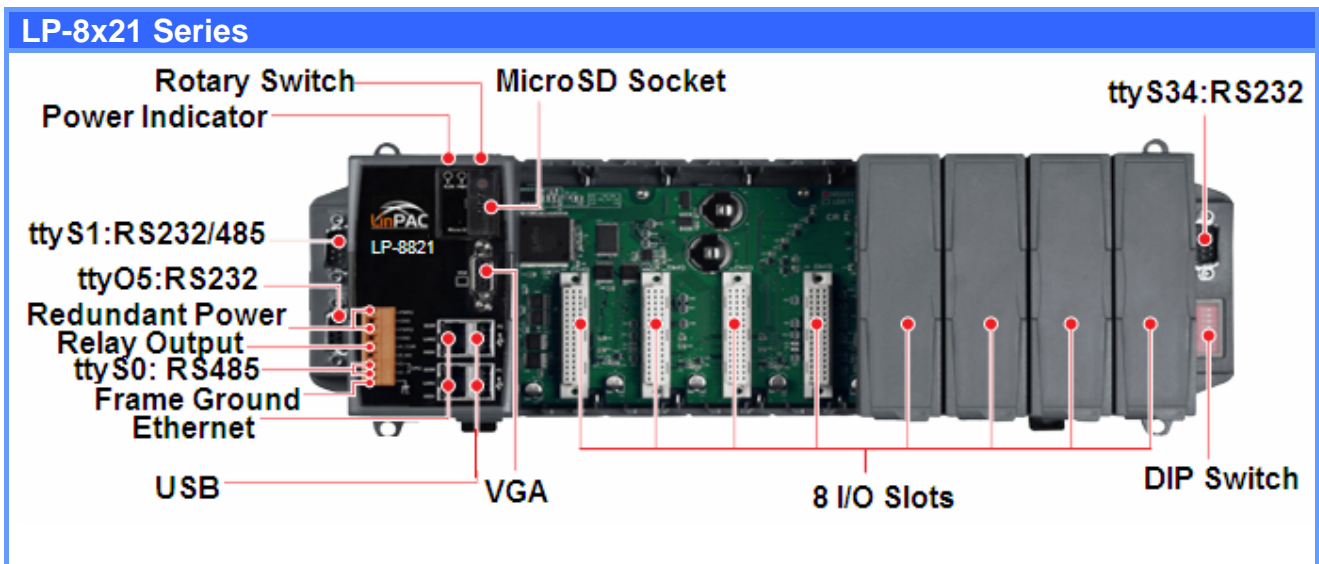

Fig. 1-2

Please note:

- ◆ The flash and microSD disk have a finite number of program-erase cycles. Important information should always be backed up on other media or storage device for long-term safekeeping.
- ◆ The Li-batterie can continually supply power to the 512 KB SRAM to retain the data for 10 years (It is recommended that batteries are changed each 5~7 year.)

2. Installation of the LP-8x21 SDK

The “LP-8x21 SDK” is a development toolkit provided by ICP DAS, which can be used to easily develop custom applications for the LP-8x21 embedded controller platform. The toolkit consists of the following items:

- ❑ LP-8x21 SDK (Linaro GCC toolchain, Libraries, header, examples files, etc.)
- ❑ Code::Blocks project file (Windows platform only)
- ❑ Basic Linux commands (Windows platform only)

The topic provides LP-8x21 SDK installation instructions for the following platforms:

- ❑ Linux
 - ◆ Download/Install LP-8x21 SDK on Linux
- ❑ Windows
 - ◆ Download/Install LP-8x21 SDK on Windows
 - ◆ Integrating LP-8x21 SDK with Code::Blocks IDE

2.1 Quick Installation of the LP-8x21 SDK

2.1.1 Download/Install LP-8x21 SDK on Linux

1. To create a “**icpdas**” folder in root directory, maybe you need to change the root user by ‘sudo’ or ‘su’ command (refer to Fig.2-1).



```
root@LinuxPC-ICPDAS: /icpdas
root@LinuxPC-ICPDAS: /#
root@LinuxPC-ICPDAS: /# pwd
/
root@LinuxPC-ICPDAS: /# mkdir icpdas
root@LinuxPC-ICPDAS: /#
root@LinuxPC-ICPDAS: /# cd icpdas
root@LinuxPC-ICPDAS: /icpdas#
root@LinuxPC-ICPDAS: /icpdas# ls
LP-8x2x_SDK_for_linux.tar.bz2
root@LinuxPC-ICPDAS: /icpdas#
root@LinuxPC-ICPDAS: /icpdas#
```

Fig. 2-1

2. Insert the installation CD into your CD-ROM driver (refer to Fig.2-2 and 2-3). Locate the “**LP-8x21_SDK_for_linux.tar.bz2**” file in the \napdos\LP-8x21\SDK\ in **/icpdas/** folder (or visit the ICP DAS website to download the latest version: <http://ftp.icpdas.com.tw/pub/cd/linpac/napdos/lp-8x21/sdk/>).

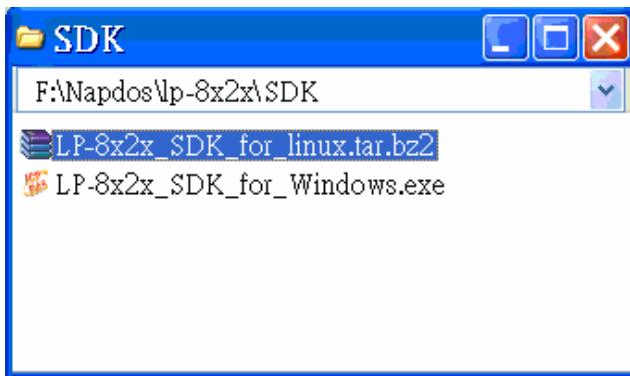

Fig. 2-2



Fig. 2-3

3. Try the following command to decompress file (refer to Fig.2-4 and Fig.2-5).

```
# bzip2 -d LP-8x21_SDK_for_linux.tar.bz2
# tar zxvf LP-8x21_SDK_for_linux.tar
```

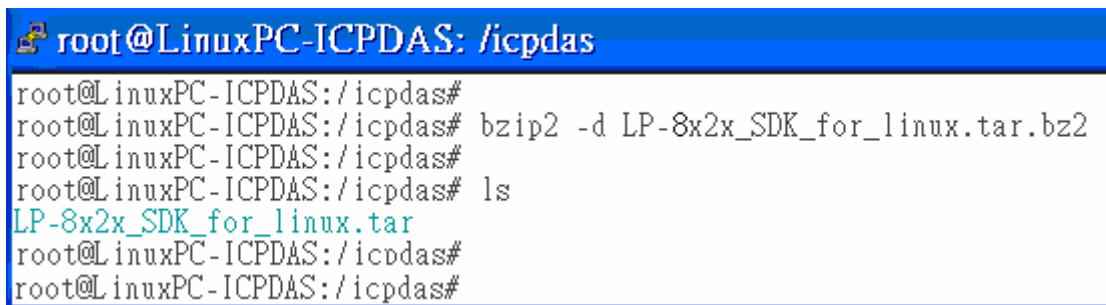

Fig. 2-4

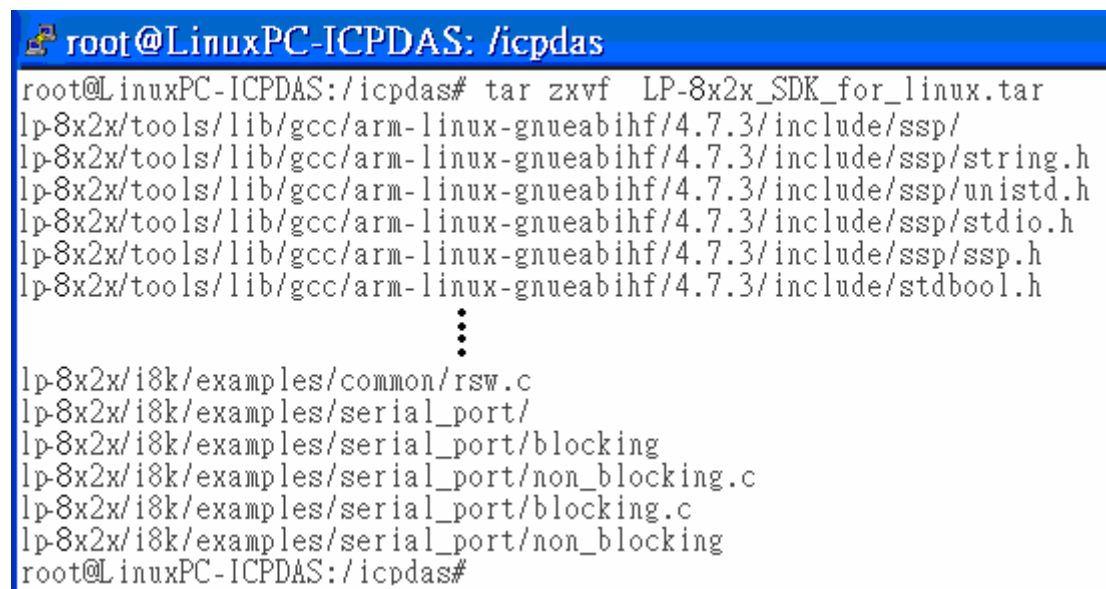

Fig. 2-5

4. Before compile the program, you need to set LP-8x21 SDK path in environment variables: using the provided environment variable script, which is called **lp8x2x.sh** (refer to Fig.2-6).

```
root@LinuxPC-ICPDAS: /icpdas
root@LinuxPC-ICPDAS:/icpdas# ls
lp-8x2x LP-8x2x_SDK_for_linux.tar
root@LinuxPC-ICPDAS:/icpdas# cd lp-8x2x/
root@LinuxPC-ICPDAS:/icpdas/lp-8x2x#
root@LinuxPC-ICPDAS:/icpdas/lp-8x2x# ls
i8k lp-8x2x.sh tools
root@LinuxPC-ICPDAS:/icpdas/lp-8x2x# . lp-8x2x.sh
root@LinuxPC-ICPDAS:/icpdas/lp-8x2x#
root@LinuxPC-ICPDAS:/icpdas/lp-8x2x# export lgrep PATH
declare -x
PATH="/icpdas/lp-8x2x/tools/bin:/icpdas/lp-8x2x/tools/sbin:/usr/local
/noweb:/usr/local/sbin:/usr/local/bin:/usr/sbin:/usr/bin:/sbin:/bin
:/usr/games"
root@LinuxPC-ICPDAS:/icpdas/lp-8x2x# cd i8k
root@LinuxPC-ICPDAS:/icpdas/lp-8x2x/i8k# ls
ChangeLog examples include lib Makefile
root@LinuxPC-ICPDAS:/icpdas/lp-8x2x/i8k#
```

Fig. 2-6

5. Type '**make**' on the command line it will execute the compile command according to the Makefile (refer to Fig.2-7).

```
root@LinuxPC-ICPDAS:
root@LinuxPC-ICPDAS:/icpdas/lp-8x2x/i8k# make
cd examples && make
make[1]: Entering directory `/icpdas/lp-8x2x/i8k/examples'
arm-linux-gnueabi-gcc -I. -I../include -c -o common/rsw.o common/rsw.c
arm-linux-gnueabi-gcc -I. -I../include -lm -o ./common/rsw ./common/rsw.o ../li
b/libi8k.a
rm -f ./common/rsw.o
arm-linux-gnueabi-gcc -I. -I../include -c -o common/timer2.o common/timer2.c
arm-linux-gnueabi-gcc -I. -I../include -lm -o ./common/timer2 ./common/timer2.o
../lib/libi8k.a
rm -f ./common/timer2.o
arm-linux-gnueabi-gcc -I. -I../include -c -o common/uart.o common/uart.c
arm-linux-gnueabi-gcc -I. -I../include -lm -o ./common/uart ./common/uart.o ../
lib/libi8k.a
:
```

Fig. 2-7

2.1.2 Download/Install LP-8x21 SDK on Windows

The LP-8x21_SDK_for_Windows.exe provides compilers, library, header, examples, and IDE workspace file (for Code::Blocks project).

1. Insert the installation CD into your CD-ROM driver.
2. Open the \napdos\LP-8x21\SDK\ folder and double-click the icon for the “LP-8x21 SDK for Windows.exe” file, when the Setup Wizard is displayed, click the “Next>” button to continue, refer to Fig. 2-8 and Fig.2-9.

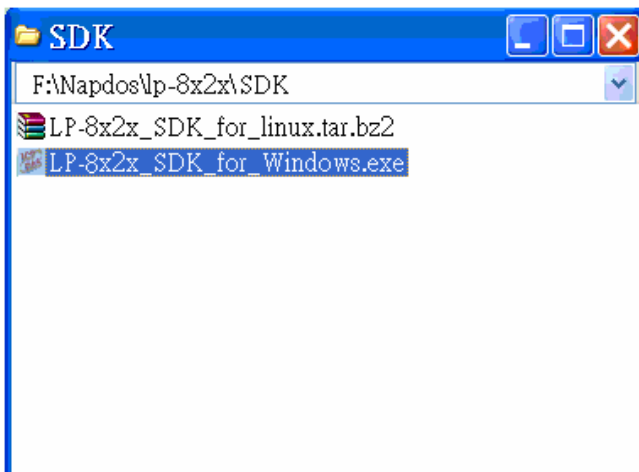

Fig. 2-8

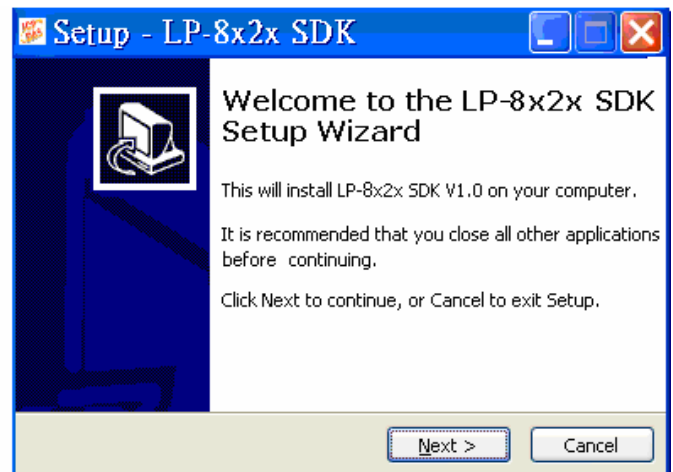

Fig. 2-9

3. Click the “I accept the agreement” option and then click the “Next” button, refer to Fig. 2-10.
4. Select Start Menu Folder option and then click the “Next” button, refer to Fig. 2-11.

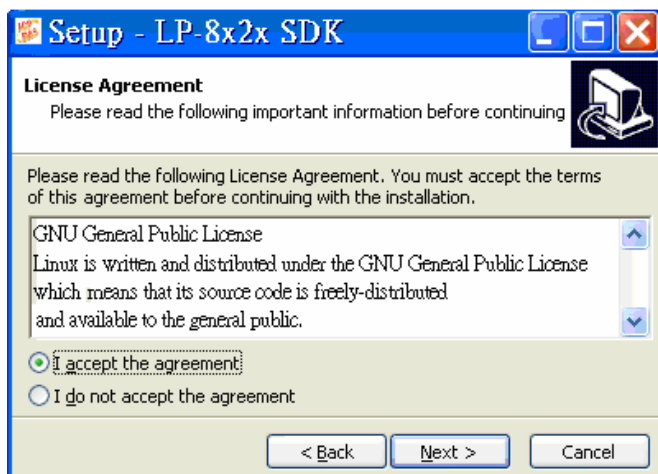

Fig. 2-10

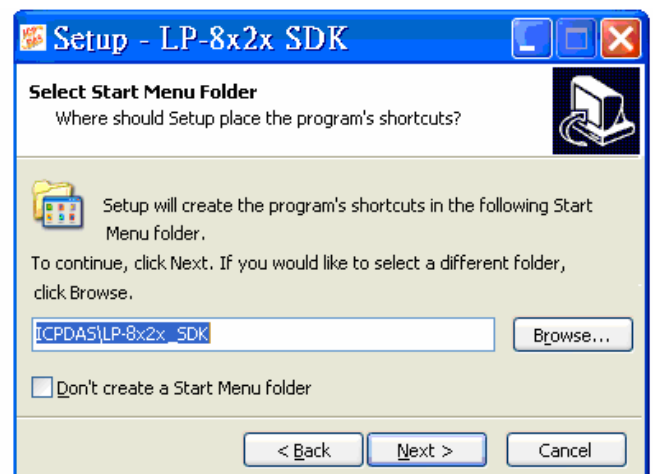

Fig. 2-11

5. The LP-8x21 SDK files will be extracted and installed and a progress bar will be displayed to indicate the status, refer to Fig 2-12.

6. Once the software has been successfully installed, click the “Finish” button to complete the development toolkit installation, refer to Fig. 2-13.

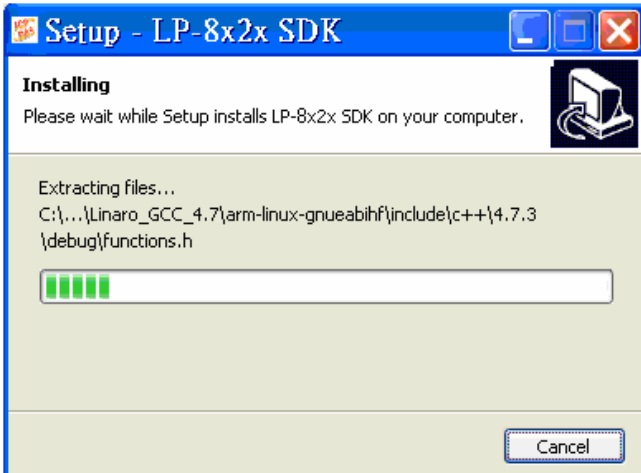

Fig. 2-12

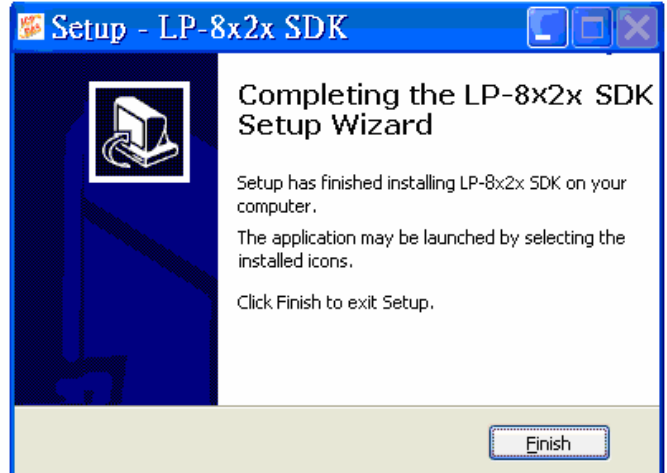

Fig. 2-13

7. Open the LP-8x21 SDK installation directory, the default data directory location is “C:\cygwin”, user can see the contents of folder. Refer to Fig 2-14 and Fig 2-15.

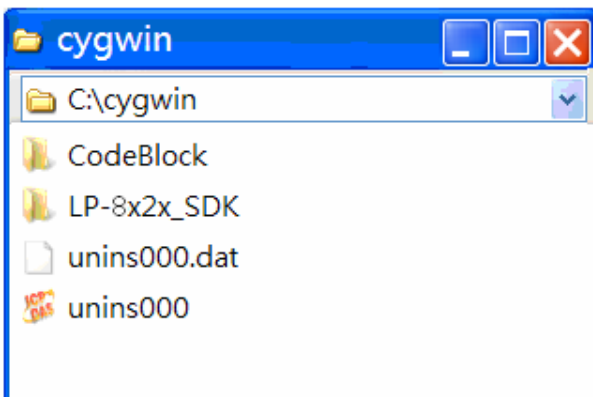

Fig. 2-14

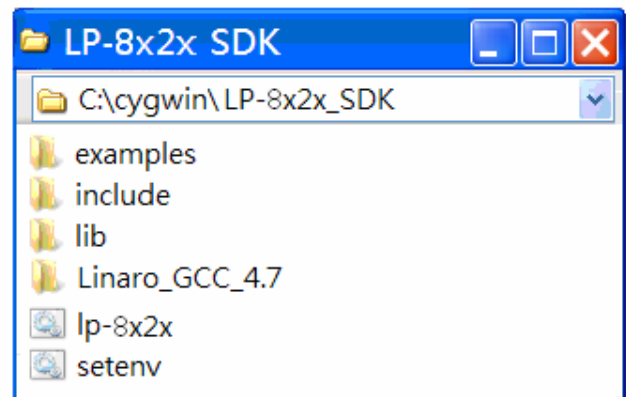

Fig. 2-15

8. From the desktop, double-click the shortcut icon for the “LP-8x21 Build Environment” or click the “Start” > “Programs” > “ICPDAS” > “LP-8x21 SDK” > “LP-8x21 Build Environment”.

A Command Prompt window will then be displayed that allows applications for the LP-8x21 to be compiled. Refer to Fig. 2-16 and Fig 2-17.

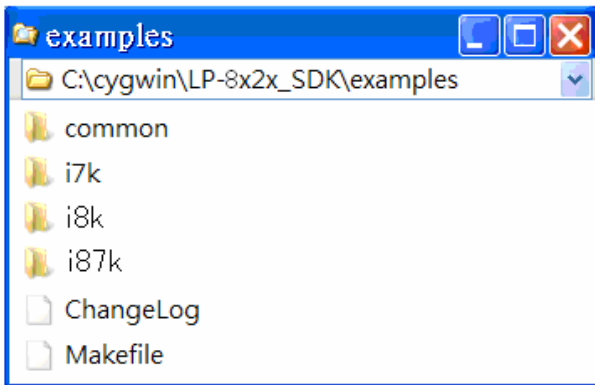

Fig. 2-16

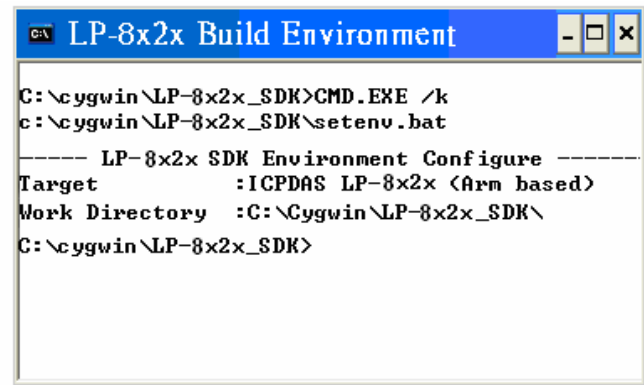

Fig. 2-17

9. Type “**make**”. A Command Prompt window will then be displayed that allows applications for the LP-8x21 to be compiled. Refer to Fig. 2-18.

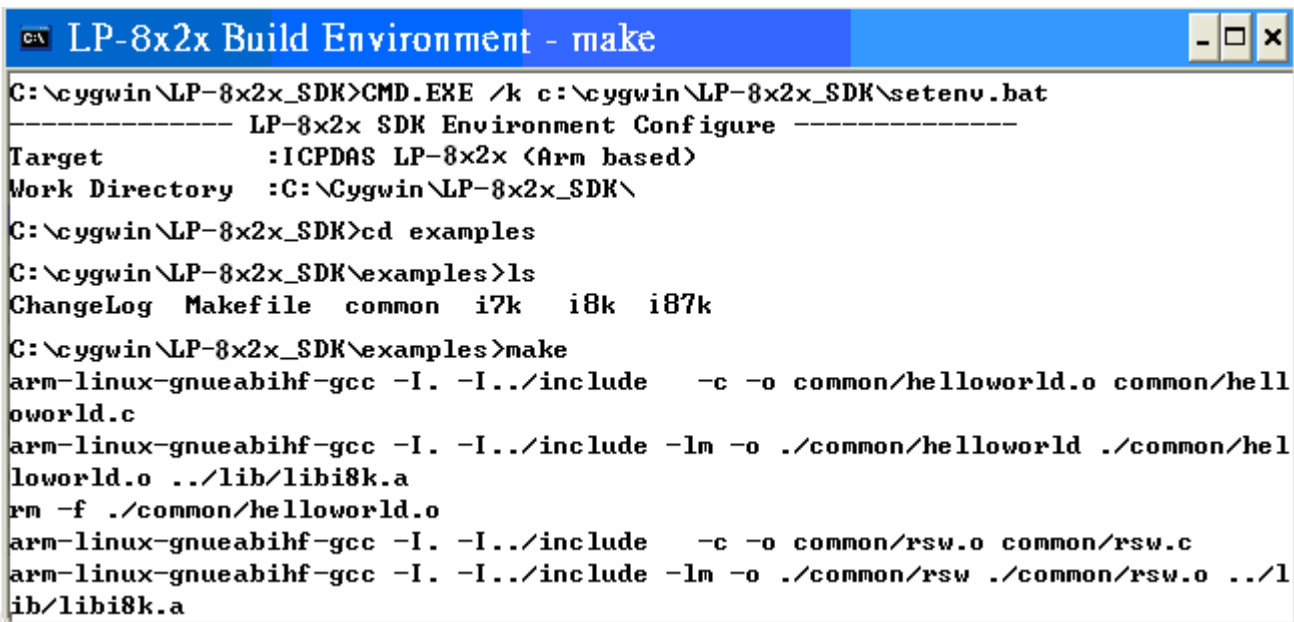

Fig. 2-18

2.1.3 Integrating LP-8x21 SDK with Code::Blocks IDE

This tutorial gives you easy-to-follow instructions, with screenshots, for setting up a compiler (the Linaro GCC compiler), a tool that will let you turn the code that you write into programs, and Code::Blocks IDE, a free development environment. This tutorial explains how to integrate LP-8x21 SDK with Code::Blocks IDE on Windows platform.

Step 1: Download Code::Blocks IDE

- Go to this website: <http://www.codeblocks.org/downloads/binaries>
- Go to the Windows 2000/ XP / Vista / 7 section, and download Windows version.

Step 2: Install Code::Block IDE

- ❑ The default install location is the C:\Program Files\CodeBlocks folder.
- ❑ A complete manual for Code::Blocks is available here:
<http://www.codeblocks.org/user-manual>

Step 3: Running in Code::Block IDE

- ❑ All files and settings that are included in a LP-8x21_SDK workspace file.
- ❑ Open the **C:\cygwin\CodeBlock** folder, and double click the "LP-8x21_SDK" as below (refer to Fig. 2-19):

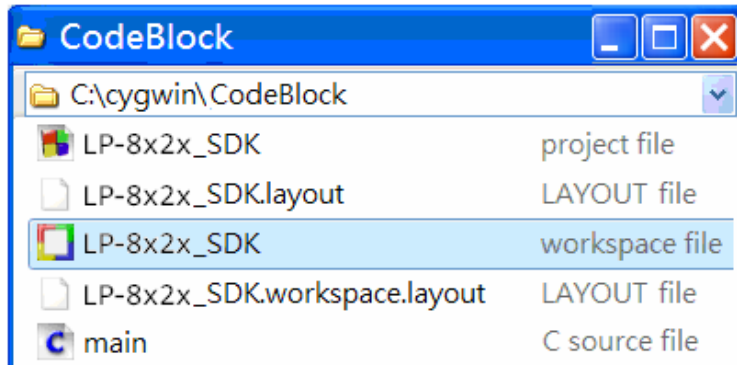

Fig. 2-19

- ❑ Following window will come up (refer to Fig. 2-20):

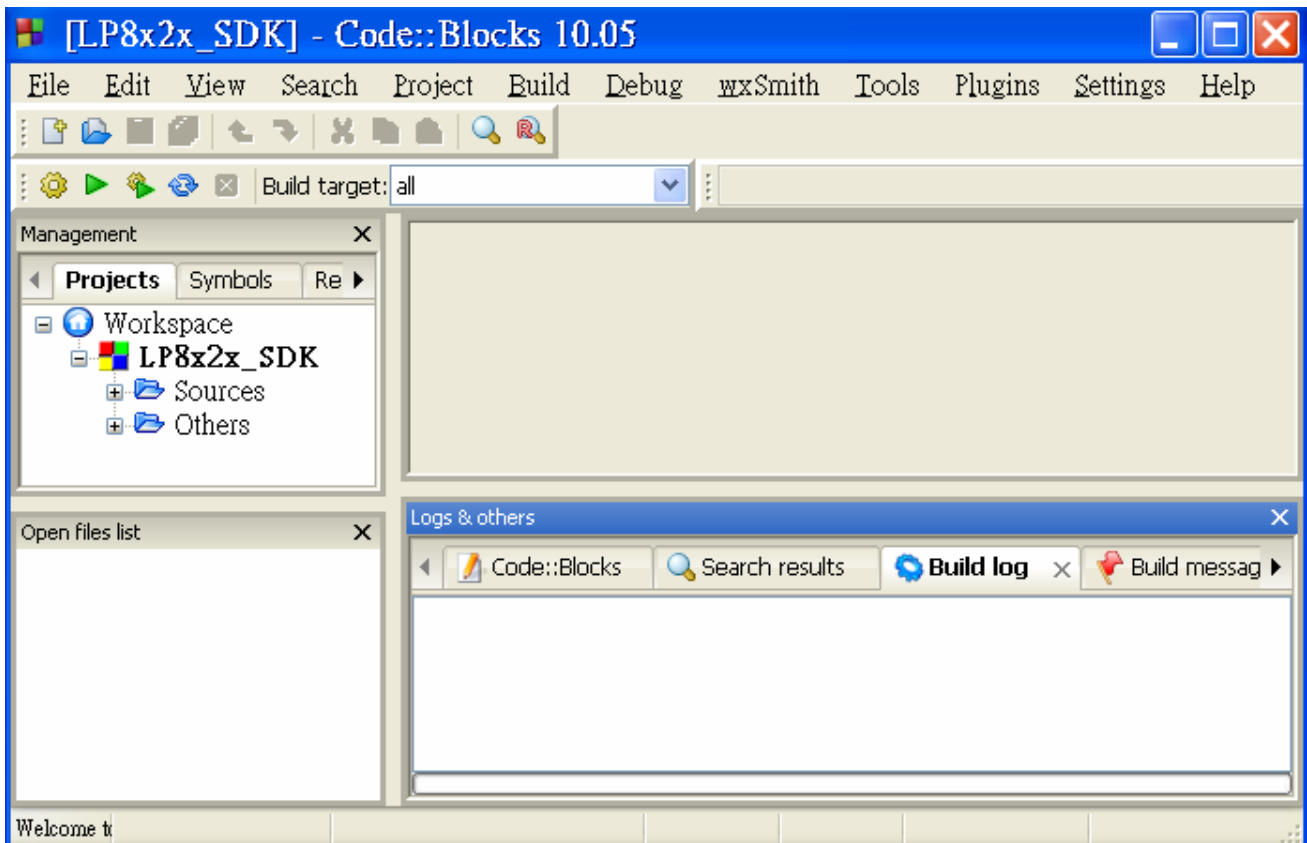

Fig. 2-20

- ❑ Check Compiler settings for Linaro GCC cross compiler : Click "Settings" > "Compiler" > "Toolchain executables tab" :

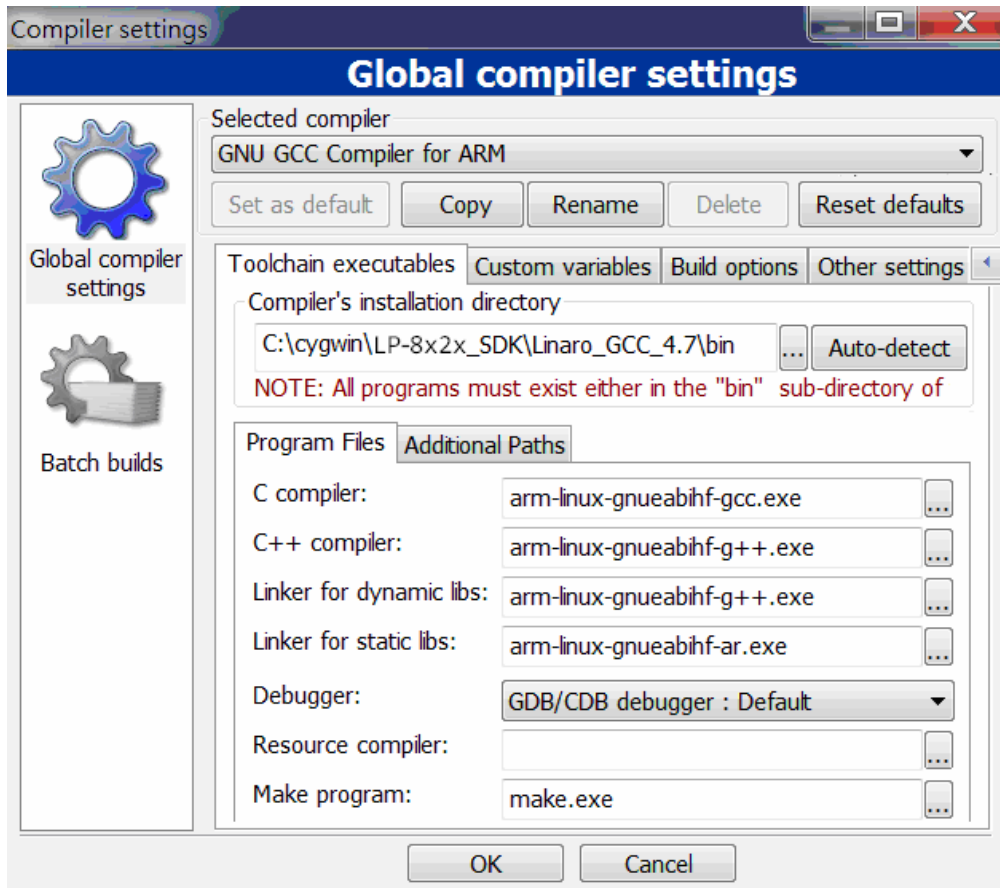

Fig. 2-21

- ❑ Click **Build** options, and it will compile the LP-8x21 project completely.

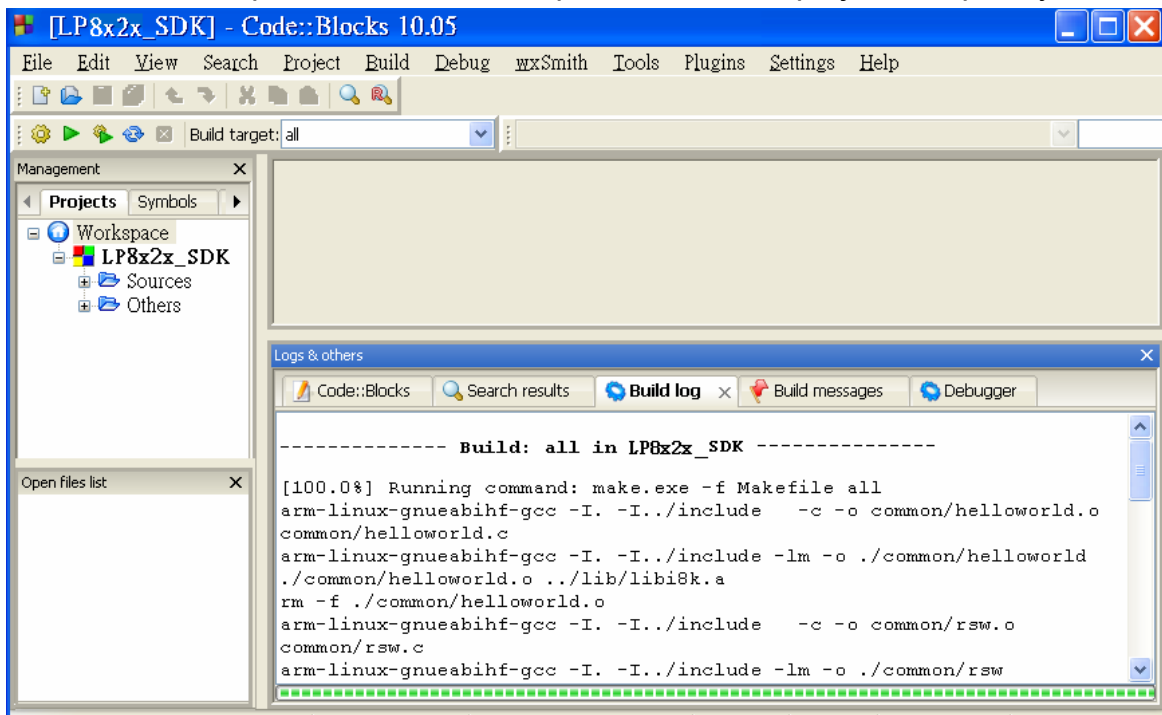

Fig. 2-22

【Note】

If you observe some characters may not display properly in cmd.exe, change the code page for the console only, do the following:

- ❑ Double-click the shortcut icon for the “LP-8x21 Build Environment” (Refer to Fig. 2-23).

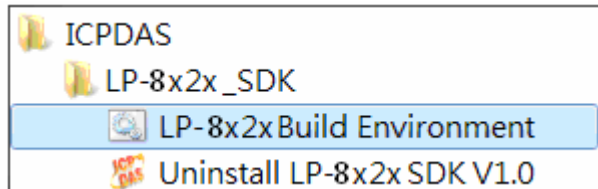

Fig. 2-23

- ❑ Type command: **chcp 65001** (Refer to Fig. 2-24 and Fig 2-25).

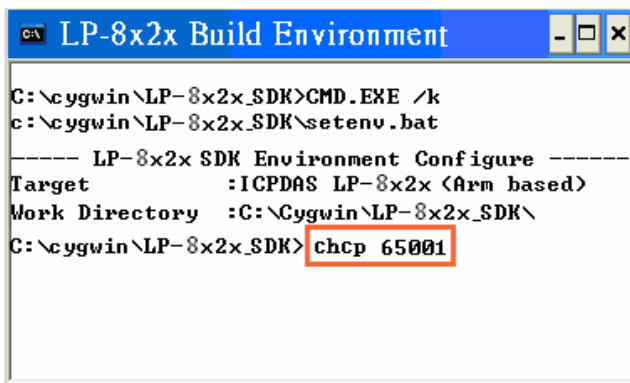

Fig. 2-24

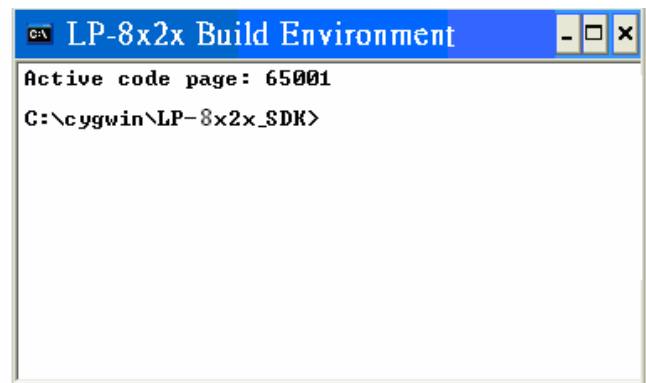

Fig. 2-25

2.2 Introduction of the LP-8x21 SDK

This section will discuss some of the techniques that are adopted in the LP-8x21 SDK, including detailed explanations that describe how to easily use the LP-8x21 SDK. The LP-8x21 SDK is based on Cygwin and is also a Linux-like environment for Microsoft Windows systems, and provides a powerful GCC cross-compiler and an IDE (Integrated Development Environment) that enables LP-8x21 applications to be quickly developed. Therefore, once an application has been created, the LP-8x21 SDK can be used to compile it into an executable file that can be run on the LP-8x21 embedded controller.

2.2.1 Introduction to Cygwin

Cygwin is a collection of free software tools originally developed by Cygnus Solutions to allow various versions of Microsoft Windows to act somewhat like a UNIX system. Cygwin is a Linux-like environment for Windows consisting of two parts:

- (1) A DLL (cygwin1.dll) which acts as a Linux emulation layer providing substantial Linux API functionality.
- (2) A collection of tools that provide users with the Linux look and feel.

2.2.2 Introduction to Cross-Compilation

Generally, program compilation is performed by running a compiler on the build platform. The compiled program will then run on the target platform. Usually these two processes are intended for use on the same platform. However, if the intended platform is different, the process is called **cross compilation**, where source code on one platform can be compiled into executable files to be used on other platforms. For example, if the “**arm-linux-gnueabi-gcc**” cross-compiler is used on an x86 windows platform, the source code can be compiled into an executable file that can run on an arm-linux platform.

So why use cross compilation? In fact, cross compilation is sometimes more complicated than normal compilation, and errors are easier to make. Therefore, this method is often only employed if the program cannot be compiled on the target system, or if the program being compiled is so large that it requires more resources than the target system can provide. For many embedded systems, cross compilation is the only possible approach.

2.2.3 Download the LP-8x21 SDK

- ❑ **For Windows systems** : (Extract the .exe file into to the **C:\ driver.**)

Download the **LP-8x2x_SDK_for_Windows.exe** file from:

ftp://ftp.icpdas.com/pub/cd/linpac/napdos/LP-8x21/sdk/LP-8x2x_SDK_for_Windows.exe

- ❑ **For Linux systems** : (Extract the .bz2 file into to the **root (/) directory.**)

Download the **lp-8x2x_sdk_for_linux.tar.bz2** file from:

ftp://ftp.icpdas.com/pub/cd/linpac/napdos/LP-8x21/sdk/lp-8x2x_sdk_for_linux.tar.bz2

Note: We recommend user to change user ID to become **root** by ‘sudo’ or ‘su’ command.

3. The Architecture of LIBI8K.A in the LP-8x21

The library file **libi8k.a** is designed for I-7000/8000/87000 applications running on the LP-8x21 Embedded Controller based on the Linux operating system, and can be applied when developing custom applications **using the GNU C language**. ICP DAS provides a wide variety of demo programs that can be used to easily understand how to implement the functions and ensure that custom projects and applications can be quickly developed.

The relationship between the libi8k.a library and the custom applications is depicted in the figure below.

The relationships among the libi8k.a and user's applications are depicted as Fig. 3-1:

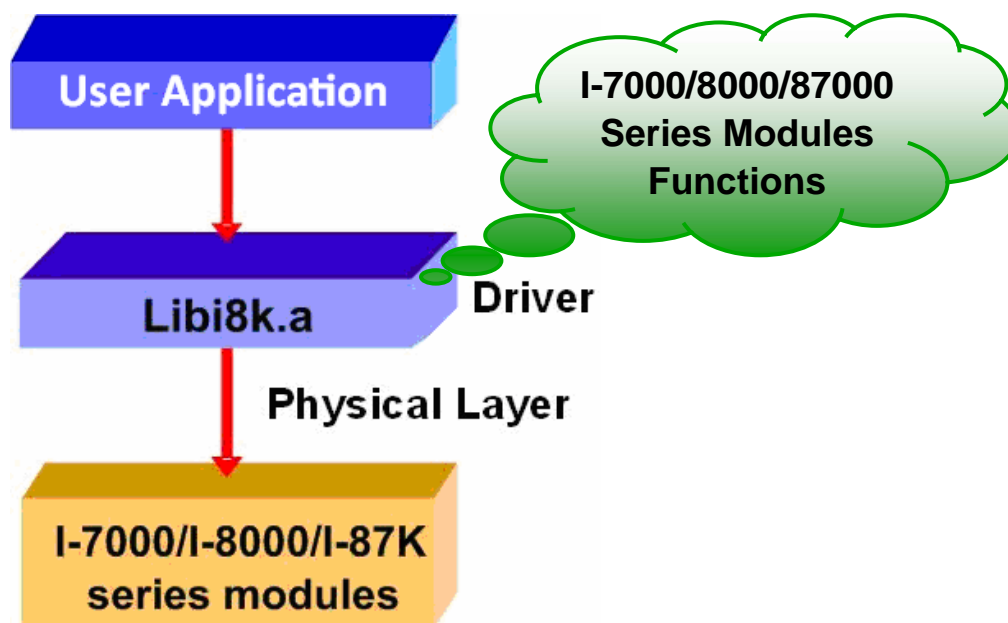

Fig. 3-1

Functions for the LP-8x21 Embedded Controller are divided into sub-groups for ease of use within the different applications:

1. System Information Functions
2. Digital Input/Output Functions
3. Analog Input Functions
4. Analog Output Functions
5. 3-axis Encoder Functions
6. 2-axis Stepper/Servo Functions

The functions contained in the libi8k.a library are specifically designed for the LP-8x21 controller, and those functions needed for specific applications can easily be determined from the descriptions provided in chapter 6 and from the demo programs described in chapter 7.

4. LP-8x21 System Settings

The following is a guide to easily configuration the LP-8x21.

4.1 Using a microSD Card

To mount a microSD storage devices follow the procedure described below:

(1) Type “**cat /proc/diskstats**” to find the device name of microSD card.

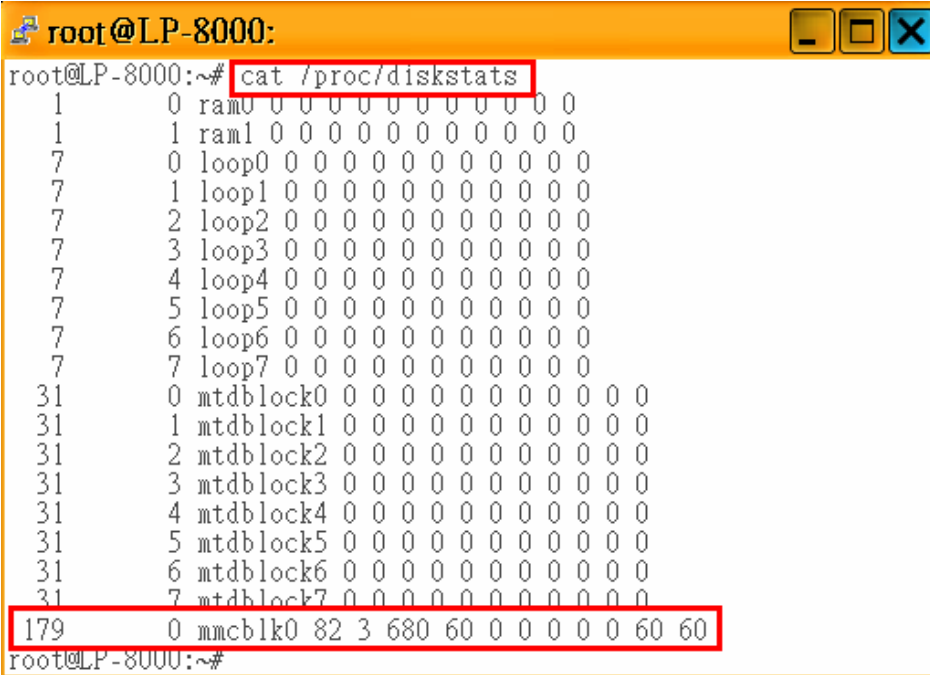

```
root@LP-8000:~# cat /proc/diskstats
1 0 ram0 0 0 0 0 0 0 0 0 0 0
1 1 ram1 0 0 0 0 0 0 0 0 0 0
7 0 loop0 0 0 0 0 0 0 0 0 0 0
7 1 loop1 0 0 0 0 0 0 0 0 0 0
7 2 loop2 0 0 0 0 0 0 0 0 0 0
7 3 loop3 0 0 0 0 0 0 0 0 0 0
7 4 loop4 0 0 0 0 0 0 0 0 0 0
7 5 loop5 0 0 0 0 0 0 0 0 0 0
7 6 loop6 0 0 0 0 0 0 0 0 0 0
7 7 loop7 0 0 0 0 0 0 0 0 0 0
31 0 mtddblock0 0 0 0 0 0 0 0 0 0 0
31 1 mtddblock1 0 0 0 0 0 0 0 0 0 0
31 2 mtddblock2 0 0 0 0 0 0 0 0 0 0
31 3 mtddblock3 0 0 0 0 0 0 0 0 0 0
31 4 mtddblock4 0 0 0 0 0 0 0 0 0 0
31 5 mtddblock5 0 0 0 0 0 0 0 0 0 0
31 6 mtddblock6 0 0 0 0 0 0 0 0 0 0
31 7 mtddblock7 0 0 0 0 0 0 0 0 0 0
179 0 mmcblk0 82 3 680 60 0 0 0 0 60 60
root@LP-8000:~#
```

Fig 4-1

(2) Type “**mkdir /mnt/hda**” to create a directory named “hda” (Refer to Fig 4-2).

(3) Files contained on a mounted microSD card can be accessed from the **/mnt/hda** directory (Refer to Fig 4-2).

```
root@LP-8000: /mnt [103x38]
root@LP-8000:/mnt/psb# cd
root@LP-8000:/mnt# mkdir hda
root@LP-8000:/mnt# mount /dev/mmcblk0 /mnt/hda
root@LP-8000:/mnt# mount
ubi0:rootfs on / type ubifs (rw,relatime)
devtmpfs on /dev type devtmpfs (rw,relatime,size=253396k,nr_inodes=63349,mode=755)
none on /dev/pts type devpts (rw,nosuid,noexec,relatime,mode=600)
none on /proc type proc (rw,nosuid,nodev,noexec,relatime)
none on /sys type sysfs (rw,nosuid,nodev,noexec,relatime)
none on /proc/sys/fs/binfmt_misc type binfmt_misc (rw,nosuid,nodev,noexec,relatime)
none on /sys/kernel/debug type debugfs (rw,relatime)
tmpfs on /tmp type tmpfs (rw,relatime)
none on /run type tmpfs (rw,nosuid,noexec,relatime,size=50700k,mode=755)
tmpfs on /boot/uboot type tmpfs (rw,relatime)
none on /run/lock type tmpfs (rw,nosuid,nodev,noexec,relatime,size=5120k)
none on /run/shm type tmpfs (rw,nosuid,nodev,relatime)
/dev/mmcblk0 on /mnt/hda type vfat (rw,relatime,fmask=0022,dmask=0022,codepage=cp437,ioccharset=iso8859-1,shortname=mixed,errors=remount-ro)
root@LP-8000:/mnt#
```

Fig 4-2

When using a microSD card, be sure to pay attention to the following items:

1. Unmount the microSD card before removing it.
2. Do not power off or reboot the LP-8x21 while data is being written to or read from the microSD card.
3. The microSD card must be formatted with the VFAT/EXT2/EXT3 file system.

[4.1.1 Mounting a microSD Card](#)

To use a microSD card, insert the microSD card into the socket on the LP-8x21 (Refer to Fig. 1-3), and it will be automatically mounted when the LP-8x21 is booted. The files of SD card can then be access from the `/mnt/hda` directory.

If the card is not mounted automatically, type “`/etc/init.d/sd start`”, to mount it.

[4.1.2 Unmounting the microSD Card](#)

Before removing the microSD card from the LP-8x21, unmount the card by entering the following steps:

- (1) `/etc/init.d/startx stop`
- (2) `/etc/init.d/apachect1 stop`
- (3) `umount /mnt/hda`

The microSD card can then be safely removed to prevent damage to the card.

4.1.3 Scanning and repairing a microSD Card

After the LP-8x21 is booted, the microSD card will be named “/dev/mmcblk0p1“. It is recommended that the microSD card is unmounted first before attempting to perform a scan or repair.

- ❑ **blockdev**: this command is used to call block device ioctls from the command line.
e.g. `blockdev --report /dev/mmcblk0p1` (print a report for device)
`blockdev -v --getra --getbz /dev/mmcblk0p1` (get readhead and blocksize)
- ❑ **fsck.minix**: this command is used to perform a consistency check for the Linux MINIX filesystem.
e.g. `fsck.minix -r /dev/mmcblk0p1` (performs interactive repairs)
`fsck.minix -s /dev/mmcblk0p1` (outputs super-block information)
- ❑ **fsck.vfat** : this command is used to check and repair MS-DOS file systems
e.g. `fsck.vfat -a /dev/mmcblk0p1` (automatically repair the file system)
`fsck.vfat -l /dev/mmcblk0p1` (list path names of files being processed)
- ❑ **mkfs**: this command is used to build a Linux file system on a device, usually a hard disk partition.
e.g. `mkfs -t vfat /dev/mmcblk0p1` (specifies the type of file system to be built)
`mkfs -c vfat /dev/mmcblk0p1`
(check the device for bad blocks before building the file system)
- ❑ **mkfs.minix**: this command is used to make a MINIX filesystem.
e.g. `mkfs.minix /dev/mmcblk0p1` (create a Linux MINIX file-system)
`mkfs.minix -c /dev/mmcblk0p1`
(check the device for bad blocks before creating the file system)
- ❑ **mkfs.vfat**: this command is used to make an MS-DOS filesystem.
e.g. `mkfs.vfat -A /dev/mmcblk0p1` (use Atari variation of the MS-DOS filesystem)
`mkfs.vfat -v /dev/mmcblk0p1` (verbose execution)

4.2 Using a USB Storage Device

USB storage devices are not automatically mounted to the LP-8x21, so it must be manually mounted before attempting to access the USB storage device.

4.2.1 Mounting a USB Storage Device

To mount a USB storage devices follow the procedure described below:

- (1) Type “**mkdir /mnt/usb**” to create a directory named “usb”.
- (2) Type “**mount /dev/sda1 /mnt/usb**” to mount the USB storage device to the usb directory and then type “**ls /mnt/usb**” to view the contents of the USB storage device.
(Refer to Fig 4-3)

```
# mkdir /mnt/usb
#
# cat /proc/diskstats | grep sda*
 8  0 sda 37 62 106 260 0 0 0 0 0 254 260
 8  1 sda1 98 98 0 0
#
# mount /dev/sda1 /mnt/usb
# mount
rootfs on / type rootfs (rw)
/dev/root on / type jffs2 (rw)
proc on /proc type proc (rw)
sysfs on /sys type sysfs (rw)
tmpfs on /var type tmpfs (rw)
shmfs on /dev/shm type tmpfs (rw)
usbfs on /proc/bus/usb type usbfs (rw)
/dev/mmcblk0p1 on /mnt/hda type vfat
(rw,umask=0022,dmasks=0022,codepage=cp437,iocharset=iso8859-1)
/dev/ram0 on /mnt/ramfs type minix (rw)
/dev/sda1 on /mnt/usb type vfat
(rw,umask=0022,dmasks=0022,codepage=cp437,iocharset=iso8859-1)
#
# ls /mnt/usb
0429.doc  2009.avi
```

Fig 4-3

4.2.2 Unmounting the USB Storage Device

Before removing the USB storage device from the LP-8x21, the device must be unmounted to prevent any damage to the device. To unmount the device, type the “**umount /mnt/usb**” command and then remove the USB storage device.

4.3 WDT

The process can be divided into four steps, which are described below:

(1) Type the “**devmem2 0x01000000 b 0x81**” to **set and enable WDT**(Refer to Fig 4-4).

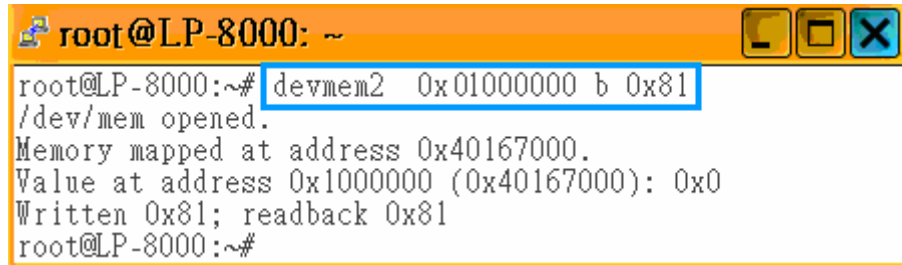

```
root@LP-8000: ~  
root@LP-8000:~# devmem2 0x01000000 b 0x81  
/dev/mem opened.  
Memory mapped at address 0x40167000.  
Value at address 0x1000000 (0x40167000): 0x0  
Written 0x81; readback 0x81  
root@LP-8000:~#
```

Fig 4-4

(2) Type the “**devmem2 0x01000000 b**” to read WDT setting. (Refer to Fig 4-5)

(3) Type the “**devmem2 0x0100f000 b 0x01**” to **reboot WDT immediately** (Refer to Fig 4-5).

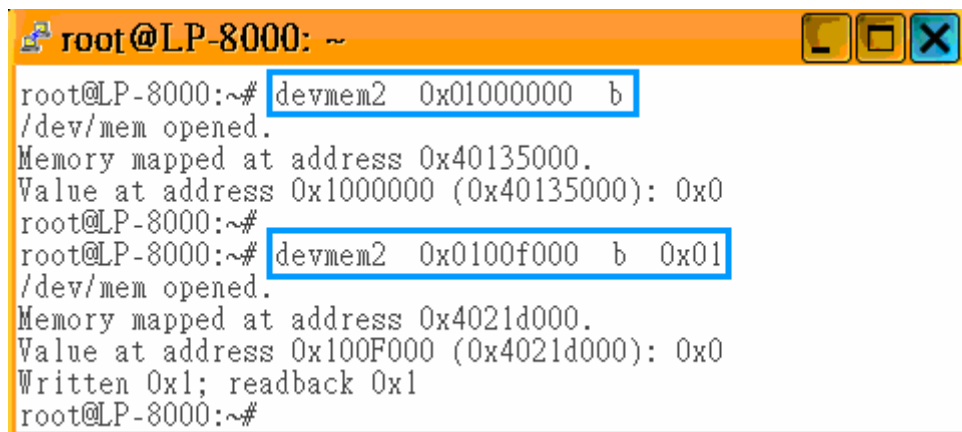

```
root@LP-8000: ~  
root@LP-8000:~# devmem2 0x01000000 b  
/dev/mem opened.  
Memory mapped at address 0x40135000.  
Value at address 0x1000000 (0x40135000): 0x0  
root@LP-8000:~#  
root@LP-8000:~# devmem2 0x0100f000 b 0x01  
/dev/mem opened.  
Memory mapped at address 0x4021d000.  
Value at address 0x100F000 (0x4021d000): 0x0  
Written 0x1; readback 0x1  
root@LP-8000:~#
```

Fig 4-5

(4) Type the “**devmem2 0x0100f000 b**” to **refresh WDT** (Refer to Fig 4-6).

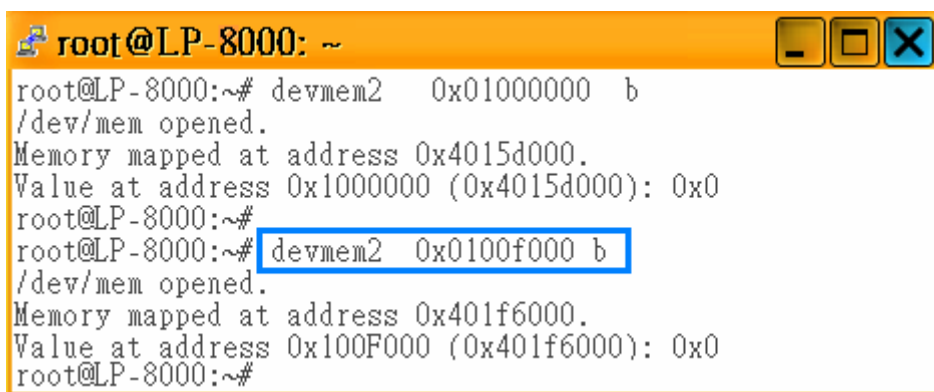

```
root@LP-8000: ~  
root@LP-8000:~# devmem2 0x01000000 b  
/dev/mem opened.  
Memory mapped at address 0x4015d000.  
Value at address 0x1000000 (0x4015d000): 0x0  
root@LP-8000:~#  
root@LP-8000:~# devmem2 0x0100f000 b  
/dev/mem opened.  
Memory mapped at address 0x401f6000.  
Value at address 0x100F000 (0x401f6000): 0x0  
root@LP-8000:~#
```

Fig 4-6

5. Instructions for the LP-8x21

This section, provides an introduction to some of the more commonly used Linux instructions. These Linux instructions are similar to those used in DOS, and are generally expressed in lower case letters.

5.1 Basic Linux Instructions

5.1.1 ls : lists the file information (Equivalent DOS Command: dir)

Parameter	Description	Example
-l	Lists detailed information related to the files	ls -l
-a	Lists all files, including hidden files	ls -a
-t	Lists the files arranged in date/time order	ls -t

5.1.2 cd directory: Changes directory (Equivalent DOS Command: cd)

Parameter	Description	Example
..	Move to the parent directory	cd ..
~	Move back to the root directory	cd ~
/	Path component separator	cd /root/i8k

5.1.3 mkdir: creates a subdirectory (Equivalent DOS Command: md)

Parameter	Description	Example
-p	No error if the subdirectory exists, and creates parent directories as needed	mkdir -p directory

5.1.4 rmdir: deletes the subdirectory which must be empty (Equivalent DOS Command: rd)

Parameter	Description	Example
-p	Removes the specified DIRECTORY, then attempts to remove each parent directory component with the same path name	rmdir -p directory

5.1.5 rm: deletes (removes) the file or directory (Equivalent DOS Command: delete)

Parameter	Description	Example
-i	Displays a warning message before deleting	rm -i test.exe
-r	Deletes the directory even if it isn't empty	rm -r test.exe
-f	No warning message displayed when deleting	rm -f test.exe

5.1.6 cp: copies one or more files (Equivalent DOS Command: copy)

Parameter	Description	Example
-R	Performs a recursive copy	cp -R test bak
-i	Displays a confirmation prompt before overwriting	cp -i test bak
-l	Links the files instead of copying them	cp -l test bak

5.1.7 mv: moves or renames a file or directory (Equivalent DOS Command: move)

Parameter	Description	Example
-f	Does not display a confirmation prompt before overwriting	cp -f sour des
-i	Displays a confirmation prompt before overwriting	cp -i /sour /des

5.1.8 pwd: displays the full path of the current working directory

5.1.9 who: displays a list of the users current logged on

5.1.10 chmod: changes the access permissions for a file

Syntax → chmod ??? file -> ??? means owner : group : all users

For example: chmod 754 test.exe

7 5 4 -> 111(read, write, execute)

101(read, write, execute)

100(read, write, execute)

The first number 7: the **owner** can read and write and execute files

The second number 5: the **group** can only read and execute files

The third number 4: **all users** can only read files

5.1.11 uname: displays the Linux version information

5.1.12 ps: displays a list of the currently active procedures

5.1.13 ftp: transfers a file using the file transfer protocol (FTP)

ftp IPAdress (Example: ftp 192.168.0.200 – > connet to ftp server)

! : temporarily exits the FTP

exit : back to the ftp

bin : transfers files in “binary” mode

get : downloads a file from the LinPAC to the Host (For example: get /mnt/hda/test.exe
c:/test.exe)

put : uploads a file from the host to the LinPAC (For example: put c:/test.exe
/mnt/hda/test.exe)

bye : exits FTP

5.1.14 telnet: establishes a connection to another PC via Telnet terminal

Syntax: telnet IPAdress

For example: telnet 192.168.0.200 (will allow remote control of the LP-8x21)

5.1.15 date: prints or sets the system date and time

5.1.16 hwclock: queries and sets the hardware clock (RTC)

Parameters: (1) -r: reads the hardware clock and prints the time on a standard output.
(2) -w: sets the hardware clock to the current system time.

5.1.17 netstat: displays the current state of the network

Parameters: [-a]: list all states (For example: netstat -a)

5.1.18 ifconfig: displays the ip and network mask information (Equivalent DOS Command: ipconfig)

5.1.19 ping: used to test whether the host in a network is reachable

Syntax: ping IPAdress

For example : ping 192.168.0.1

5.1.20 clear: clears the screen

5.1.21 passwd: used to change the password

5.1.22 reboot: reboots the LinPAC (or use 'shutdown -r now')

5.2 General GCC Instructions

The GNU Compiler Collection (GCC) is a compiler system developed by the collaborative GNU Project that can be used to compile source code written using either ANSIC or Tranditional C into executable files. Executable files compiled using GCC can be executed within different operating system and different hardware systems. The GCC is distributed by the Free Software Foundation and is free of charge. Consequently, it has become very popular with users of Unix-based systems.

Fig. 5-1 below provides an illustration of the compilation procedure within Linux.

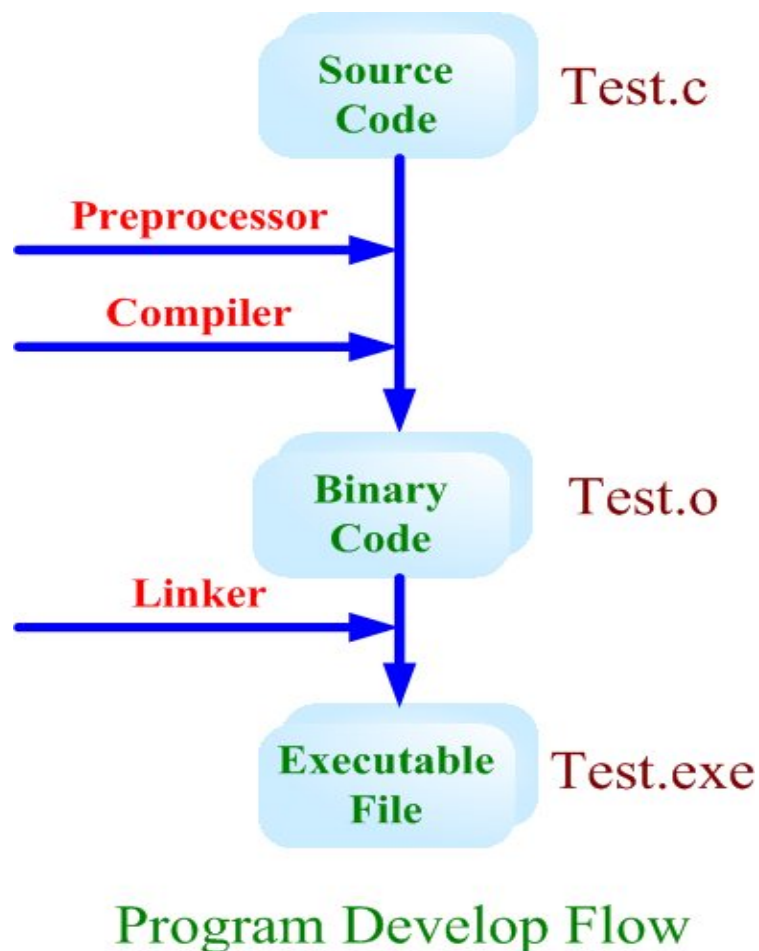

Fig. 5-1

The following is an overview of some of the common GCC instructions that will provide a guide for compiling *.c files to *.exe applications together with an explanation of the parameters used by the GCC during the compilation process.

5.2.1 Compile without linking to the LP-8x21 library

(1) Purpose: *.c to *.exe

Command: arm-linux-gnueabi-gcc -o target source.c

Parameter:

-o target: assigns the name of the output file

source.c: the C source code file

Example : arm-linux-gnueabi-gcc -o helloworld.exe helloworld.c

Output File : helloworld.exe

(2) Purpose: *.c ... *.c to *.exe

Command: arm-linux-gnueabi-gcc -c source.c

Command: arm-linux-gnueabi-gcc -o target object.o

Parameter:

-o target: assigns the name of the output file

source.c: the C source code file

object.o: the object file

Example: arm-linux-gnueabi-gcc -c main.c helloworld.c hi.c

arm-linux-gnueabi-gcc -o main.exe main.o helloworld.o hi.o

Output File: main.exe

5.2.2 Compile by linking to the LP-8x21 library (libi8k.a)

(1) Purpose: *.c to *.o

Command: arm-linux-gnueabi-gcc -IincludeDir -lm -c -o target source.c library

Parameters:

-IincludeDir: the path to the include files

-lm: includes the math library (libm.a)

-c: only compile *.c to *.o (object file)

-o target: assigns the name of the output file

source.c: the C source code file

library: the path of library

Example: arm-linux-gnueabi-gcc -I. -I../include -lm -c -o test.o

test.c ../lib/libi8k.a

Output File: test.o

(2) Purpose: *. o to *. exe

Command: arm-linux-gnueabi-gcc -lincludeDIR -lm -o target source.o

library

Parameter:

-lincludeDir: the path of include files

-lm: includes the math library (libm.a)

-o target: assigns the name of the output file

source.o: the object file

library: the path to the library

Example: arm-linux-gnueabi-gcc -I. -I../include -lm -o test.exe

test.o ../lib/libi8k.a

Output File: test.exe

(3) Purpose: *. c to *. exe

Command: arm-linux-gnueabi-gcc -lincludeDIR -lm -o target source.c library

Parameter:

-lincludeDir: the path of include files

-lm: include math library (libm.a)

-o target: assign the name of output file

source.c: source code of C

library: the path of library

Example: arm-linux-gnueabi-gcc -I. -I../include -lm -o test.exe

test.c ../lib/libi8k.a

Output File: test.exe

5.3 A Simple Example – Helloworld.c

This section describes how to 1) compile the helloworld.c file to the helloworld.exe executable file, 2) transfer the executable file (helloworld.exe) to the LP-8x21 using FTP, and 3) execute this file via the Telnet Server on the LP-8x21.

This process can be accomplished using a single PC without requiring an additional monitor for the LP-8x21. No ICP DAS modules are used in this example. However to use ICP DAS modules to control the system, refer to the demo described in the chapter 7.

The process can be divided into three steps, which are described below:

STEP 1: Compile helloworld.c to helloworld.exe

(1) Open the LP-8x21 SDK (refer to step 8 in section 2.1) and then type

“**cd examples/common**” to change the path to

C:/cygwin/LinCon8k/examples/common.

Type “**dir/w**” and to display the contents of the directory and confirm that the helloworld.c file is present. Refer to Fig. 5-2 for more details.

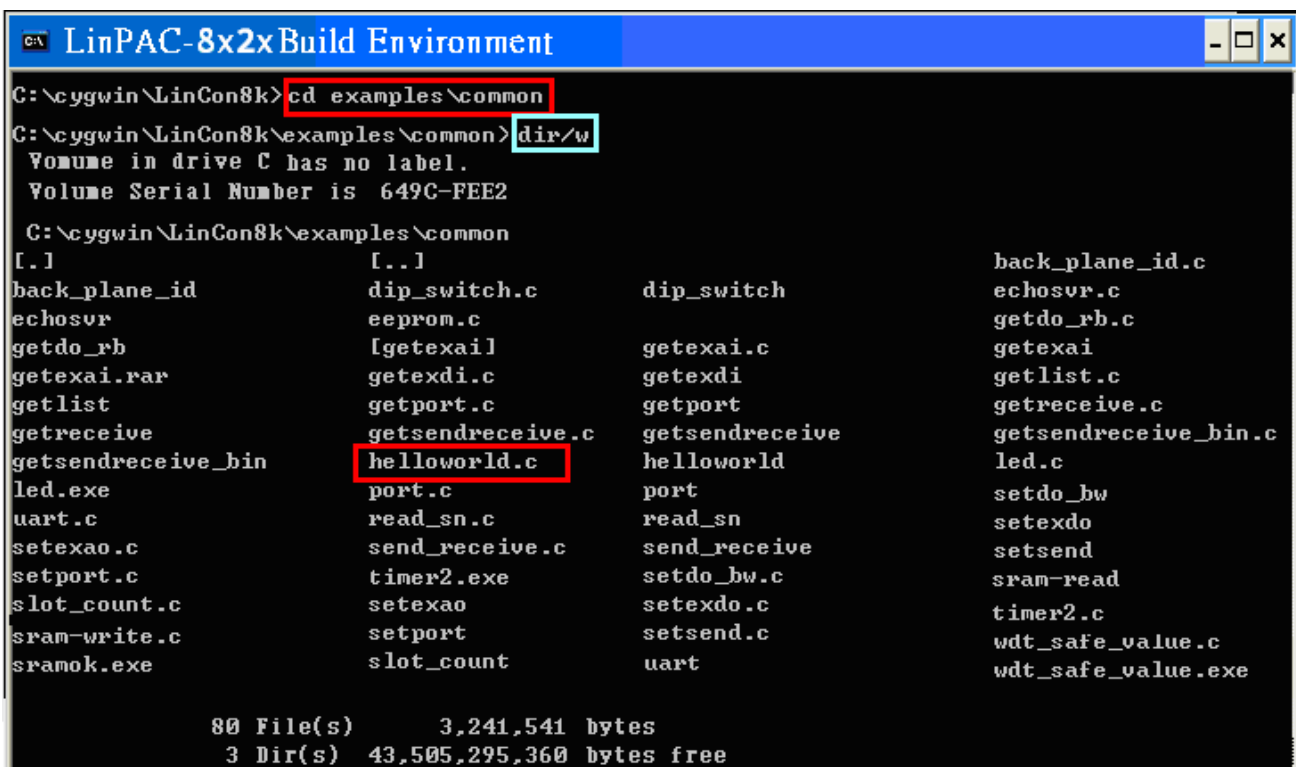

```
C:\cygwin\LinCon8k> cd examples\common
C:\cygwin\LinCon8k\examples\common> dir/w
Volume in drive C has no label.
Volume Serial Number is 649C-FEE2

C:\cygwin\LinCon8k\examples\common
[.]                [..]                back_plane_id.c
back_plane_id      dip_switch.c         dip_switch           echosvr.c
echosvr            eeprom.c             [getexai            getdo_rb.c
getdo_rb           [getexai             getexai.c           getexai
getexai.rar        getexdi.c            getexdi             getlist.c
getlist            getport.c            getport             getreceive.c
getreceive         getsendreceive.c     getsendreceive      getsendreceive_bin.c
getsendreceive_bin helloworld.c         helloworld          led.c
led.exe            port.c               port                setdo_bw
uart.c             read_sn.c            read_sn             setexdo
setexao.c          send_receive.c       send_receive        setsend
setport.c          timer2.exe           setdo_bw.c         sram-read
slot_count.c      setexao              setexdo.c          timer2.c
sram-write.c      setport              setsend.c          wdt_safe_value.c
sramok.exe         slot_count           uart                wdt_safe_value.exe

80 File(s)         3,241,541 bytes
3 Dir(s)           43,505,295,360 bytes free
```

Fig. 5-2

- (2) Type the command “**arm-linux-gnueabi-gcc -o helloworld.exe helloworld.c**” to compile helloworld.c into helloworld.exe, then type “**dir/w**” to display the contents of the directory and confirm that the helloworld.exe file has been created. (Refer to Fig. 5-3)

```

C:\cygwin\LinCon8k\examples\common>dir/w
Volume in drive C has no label.
Volume Serial Number is 649C-FEE2
C:\cygwin\LinCon8k\examples\common

[.]                [..]                back_plane_id.c    back_plane_id.exe
echosvr.c          echosvr.exe         eeprom.c           eeprom.exe
getdo_rb.c         getdo_rb.exe        getexai.c           getexai.exe
getexdi.c          getexdi.exe         getlist.c           getlist.exe
getport.c          getport.exe         getreceive.c        getreceive.exe
getsendreceive.c  getsendreceive.exe getsendreceive_bin.c getsendreceive_bin.exe
helloworld.c       helloworld.exe      led.c               led.exe
port.c             port.exe            read_sn.c           read_sn.exe
rotary_id.c        rotary_id.exe       send_receive.c      send_receive.exe
setdo_hw.c         setdo_hw.exe        setexao.c           setexao.exe
setexdo.c          setexdo.exe         setport.c           setport.exe
setsend.c          setsend.exe         sram.c              sram.exe
timer.c            timer.exe           timer2.c            timer2.exe
uart.c             uart.exe            wdt.c               wdt.exe
wdt_safe_value.c  wdt_safe_value.exe

                    56 File(s)          2,257,242 bytes
                    2 Dir(s)          98,268,422,144 bytes free

```

Fig. 5-3

STEP 2: Transfer helloworld.exe to the LP-8x21

Two methods can be used to transfer files to the LP-8x21:

<Method one> Using the “DOS Command Prompt”

- (1) Open a “DOS Command Prompt” and type the ftp IP Address of the LP-8x21, for example: **ftp 192.168.0.200** to establish a connection to the FTP Server on the LP-8x21. When prompted, type the **User_Name** (default value is “**root**”) and **Password** (default value is “**icpdas**”) to establish a connection to the LP-8x21.
- (2) Before transferring the files to the LP-8x21, type the “**bin**” command to ensure that the file is transferred to the LP-8x21 in **binary mode**. (refer to Fig. 5-4)

```

D:\WINDOWS\System32\cmd.exe - ftp 192.168.0.200
C:\>ftp 192.168.0.200
Connected to 192.168.0.200.
220 localhost FTP server (GNU inetutils 1.4.2) ready.
User (192.168.0.200:(none)): root
331 Password required for root.
Password:
230- MOKI 0.90
230 User root logged in.
ftp: bin
200 Type set to I.
ftp>

```

Fig.5-4

- (3) Type the command “**put C:/cygwin/LinCon8k/examples/common/helloworld.exe helloworld.exe**” to transfer the helloworld.exe file to the LP-8x21. Once the message “**Transfer complete**” is displayed, then transfer process has been completed. To disconnect from the LP-8x21, type the “**bye**” command to return to the PC console (refer to Fig. 5-5).

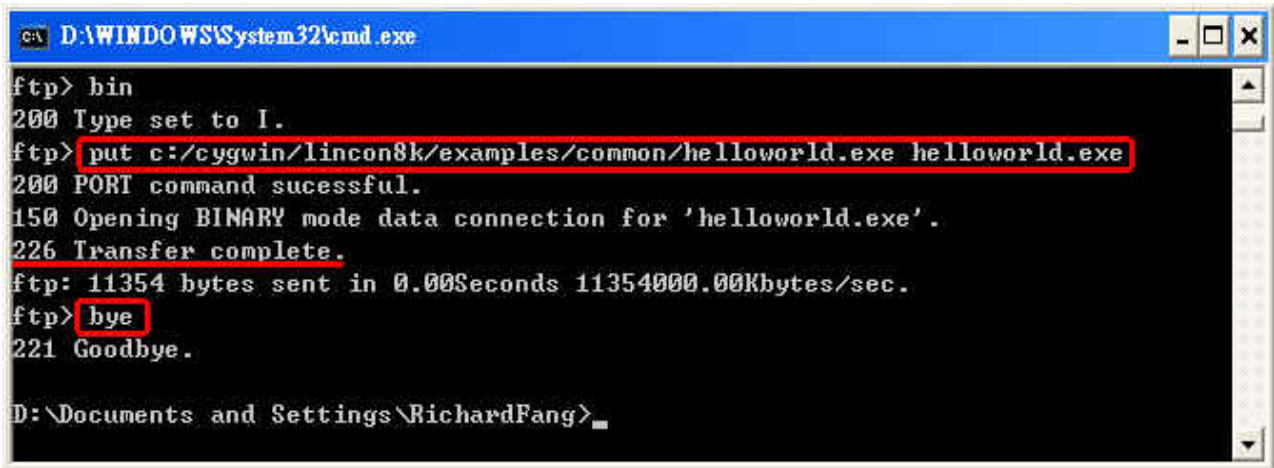

```
ftp> bin
200 Type set to I.
ftp> put c:/cygwin/lincon8k/examples/common/helloworld.exe helloworld.exe
200 PORT command successful.
150 Opening BINARY mode data connection for 'helloworld.exe'.
226 Transfer complete.
ftp: 11354 bytes sent in 0.00Seconds 11354000.00Kbytes/sec.
ftp> bye
221 Goodbye.

D:\Documents and Settings\RichardPang>
```

Fig.5-5

<Method two> Using an FTP Client:

- (1) Open the FTP Software and add an FTP Host to the LP-8x21. Type the **User_Name** (default value is “**root**”) and **Password** (default value is “**icpdas**”). Then click the “**Connect**” button to establish a connection to the ftp server on the LP-8x21. (refer to Fig. 5-6).

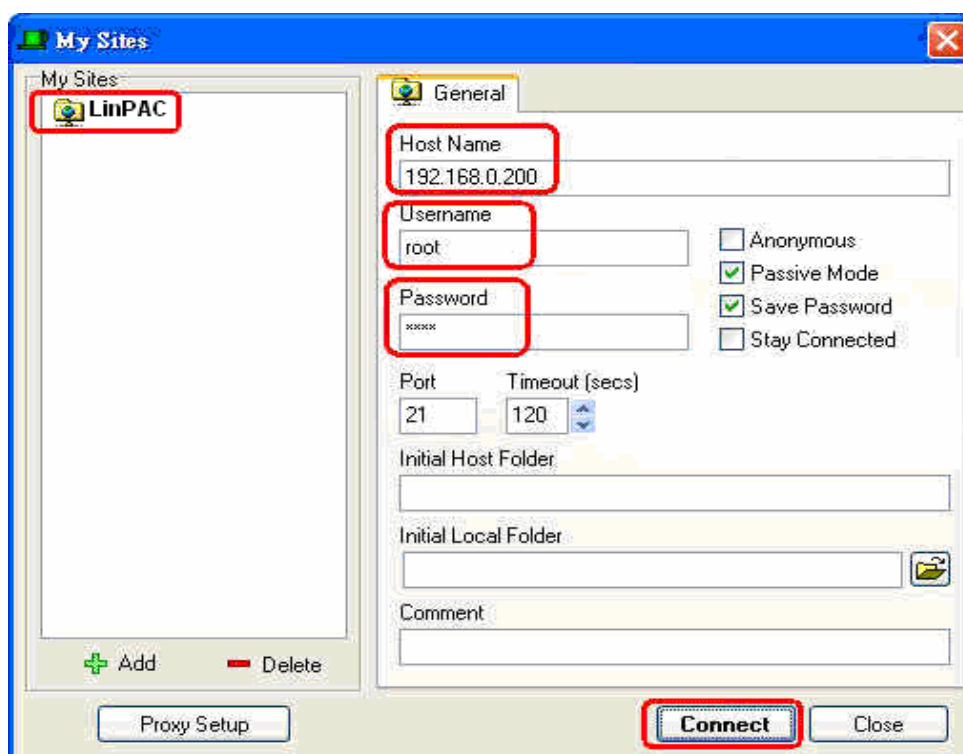

Fig.5-6

(2) Upload the “**Helloworld.exe**” file to the LP-8x21. (refer to Fig. 5-7).

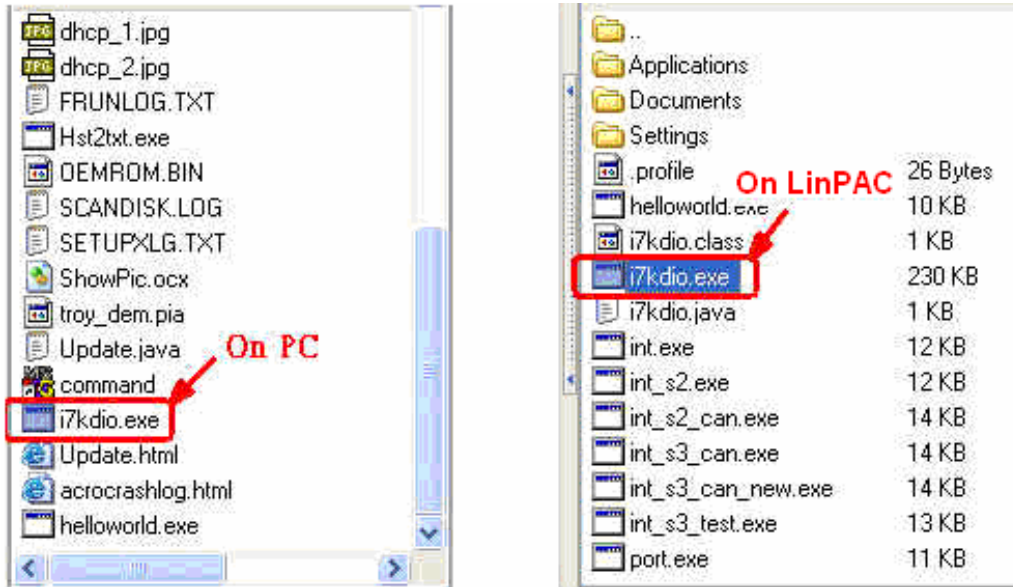

Fig. 5-7

(3) Click the helloworld.exe file in the LP-8x21 to select it and then right click the file icon and click the “**Permissions**” option. In the Properties dialog box, type 777 into the Numeric textbox, and then click the OK button. Refer to Fig. 5-8 and Fig. 5-9 for more details.

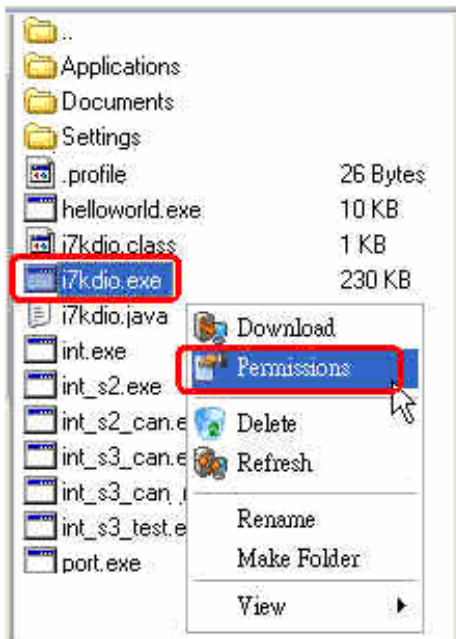

Fig.5-8

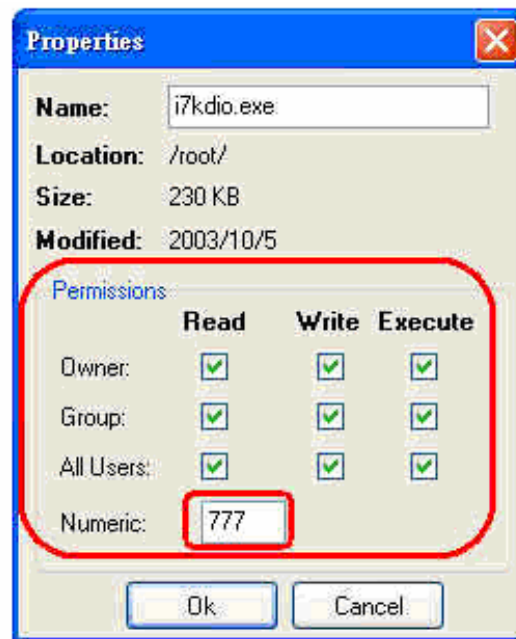
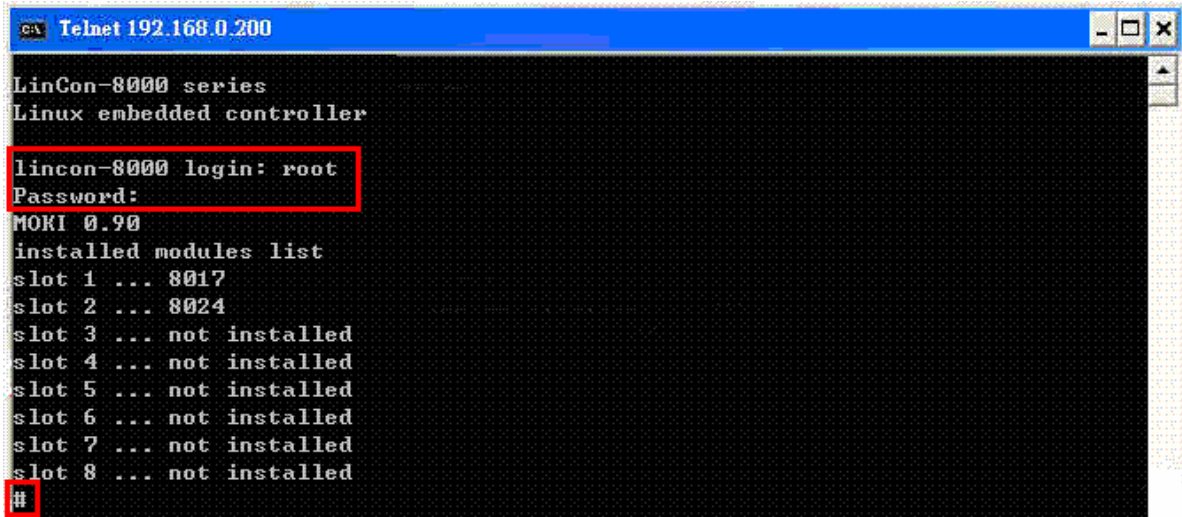

Fig.5-9

STEP 3: Use telnet to access the LP-8x21 and execute the program

- (1) Open a “DOS Command Prompt” and type the IPAddress of the LP-8x21, for example: **telnet 192.168.0.200**, to establish a connection to the Ttelnet Server on the LP-8x21. When prompted, type the **User_Name** and **Password** to establish a connection to the LP-8x21. If the “#” prompt character is displayed, it signifies that a connection to the telnet server on the LP-8x21 has been successfully established. (refer to Fig. 5-10)



```
Telnet 192.168.0.200
LinCon-8000 series
Linux embedded controller
lincon-8000 login: root
Password:
MOKI 0.90
installed modules list
slot 1 ... 8017
slot 2 ... 8024
slot 3 ... not installed
slot 4 ... not installed
slot 5 ... not installed
slot 6 ... not installed
slot 7 ... not installed
slot 8 ... not installed
#
```

Fig.5-10

- (2) Type the “**ls -l**” command to list all the files in the /root directory and verify that the helloworld.exe file is present. Type the “**chmod 777 helloworld.exe**” command to change the permissions for the helloworld.exe file. Type the “**ls -l**” command again to list all the files in the /root directory and verify the permissions assigned to the “helloworld.exe” file. This means that the file is executable. Execute the “**./helloworld.exe**” file by typing and the message “Welcome to LP-8x21” will be displayed.

The **compile, transfer** and execution processes are now complete. (refer to Fig. 5-11)

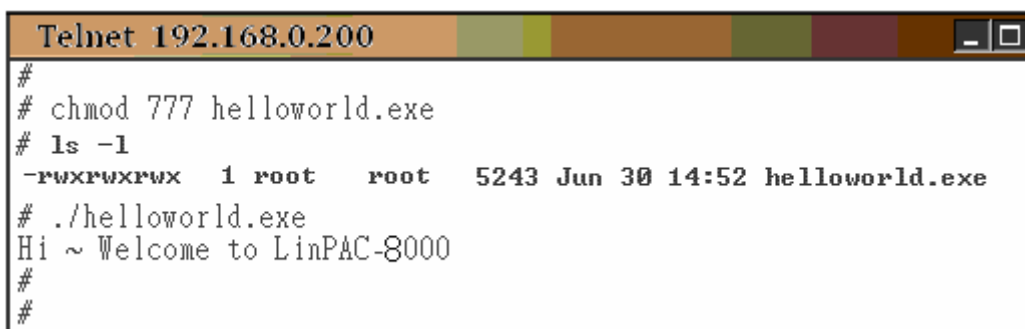

```
Telnet 192.168.0.200
#
# chmod 777 helloworld.exe
# ls -l
-rwxrwxrwx  1 root  root  5243 Jun 30 14:52 helloworld.exe
# ./helloworld.exe
Hi ~ Welcome to LinPAC-8000
#
#
```

Fig.5-11

5.4 i-Talk Utility

The **i-Talk utility** provides **fifteen instructions** that make it convenient for users to access the modules and the hardware in the LP-8x21 and can be found in the path — **/usr/local/bin**. An overview of the i-Talk utility functions is given below: (Refer to Fig. 5-12)

Instruction	Description
getlist	Lists the names of all modules inserted in the LinPAC-8000
setdo	Sets the Digital Output value for I-8K modules
setao	Sets the Analog Output value for I-8K modules
getdi	Reads the Digital Input value for I-8K modules
getai	Reads the Analog Input value for I-8K modules
setexdo	Sets the Digital Output value for I-7K/87K modules
setexao	Sets the Analog Output value for I-7K/87K modules
getexdi	Reads the Digital Input value for I-7K/87K modules
getexai	Reads the Analog Input value for I-7K/87K modules
setport	Sets the Port offset value for the module
getport	Reads the Port offset value for the module
getsend	Sends a string from the LinPAC COM port
getreceive	Receives a string from the LinPAC COM port
getsendreceive	Sends/Receives a string from the LinPAC COM port
read_sn	Reads the hardware serial number for the LP-8x21

Fig. 5-12

The Fig. 5-13 provides details of the demo programs that illustrate how to use the I-talk utility. The **I-8024W** (AO Module), **I-8017HW** (AI Module) and the **I-8055W** (DIO Module) are used in the examples shown, and they are inserted in slots 1, 2 and 3 of the LinPAC respectively. Typing the name of the instruction will display usage details for the instruction.

Instruction	Example
getlist	<i>getlist</i> Lists the names of all modules inserted in the LinPAC-8000
setdo	<i>setdo {slot} {data}</i> setdo 3 3 Sets channels 1 and 2 on the I-8055W module to ON
setao	<i>setao {slot} {channel} {data}</i> setao 1 0 2.2 Sets the Analog Output value for channel 0 on the I-8024W module to 2.2 V.
getdi	<i>getdi {slot} {type}</i> getdi 3 8 Reads the 8-bit Digital Input value from the I-8055W module
getai	<i>getai {slot} {channel} {gain} {mode}</i> getai 2 0 0 0 Reads the Analog Input value from the I-8017HW module
setexdo	<i>setexdo {slot} {1} {data}</i> setexdo 2 1 3 Sets the digital output value to the I-87K module at slot 2 <i>setexdo {slot} {comport} {data} {baudrate} {address}</i> setexdo 0 3 55 9600 2 Sets the dec digital output value to the I-7K module at COM3 port
setexao	<i>setexao {slot} {1} {data} {channel}</i> setexao 3 1 6.7 5 Sets channel 5 analog value 6.7 to the I-87K module at slot 3 <i>setexao {slot} {comport} {data} {channel} {baudrate} {address}</i> setexao 0 3 6.7 5 9600 1 Sets channel 5 analog value 6.7 to the I-7K module at COM3 port
getexdi	<i>getexdi {slot} {1}</i> getexdi 2 1 Get the dec digital input value from the I-87K module at slot 2 <i>getexdi {slot} {comport} {baudrate} {address}</i> getexdi 0 3 9600 2 Get the dec digital input value from the I-7K module at COM3 port
getexai	<i>getexai {slot} {1} {channel}</i> getexai 2 1 5 Get channel 5 analog value from the I-87K module at slot 2 <i>getexai {slot} {comport} {channel} {baudrate} {address}</i> getexai 0 3 5 115200 2 Get channel 5 analog value from the I-7K module at COM3 port
read_sn	<i>read_sn</i> Reads the hardware serial number for the LinPAC-8000 <i>Serial number = 01-000018062e62</i>

Fig. 5-13

6. LIBI8K.A

This section provides examples that focus on the description of and application of the functions found in the Libi8k.a library. The functions contained in the Libi8k.a library can be classified into three groups, as illustrated in Fig. 6-1.

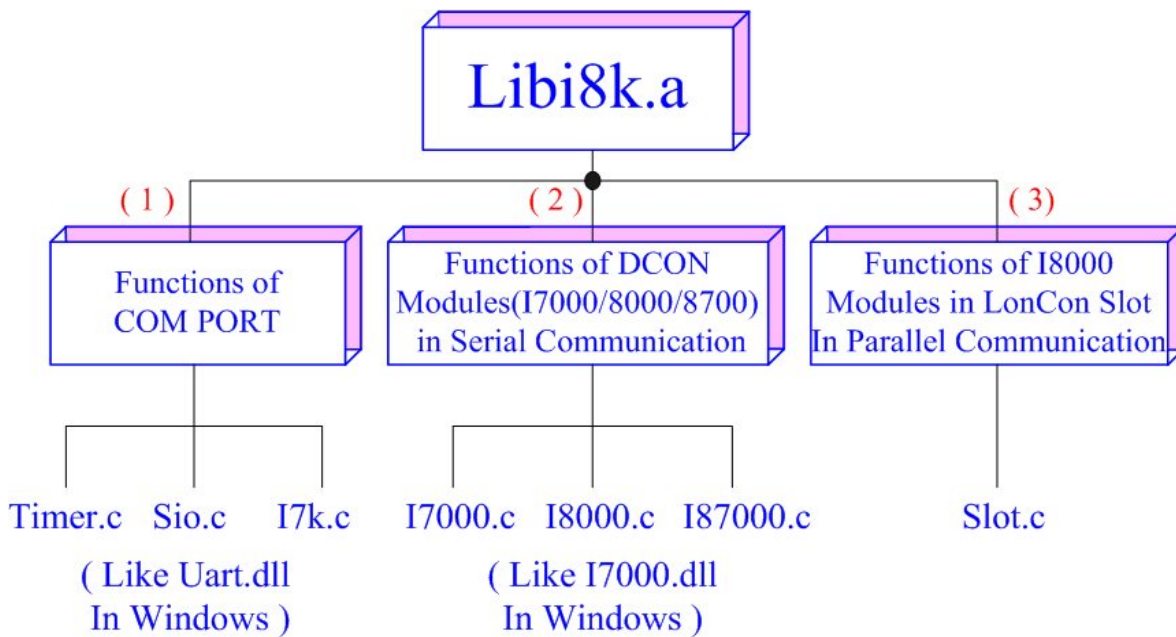

Structure of Libi8k.a

Fig. 6-1

The functions node (1) and (2) in the diagram for the Libi8k.a library are the same as those of the DCON.DLL Driver (including Uart.dll and I7000.dll) as used in the DCON modules (I-7000/ I-8000/ I-87000 for serial communication). For more details, refer to the DCON.DLL Driver manual which includes a description of how to use the functions on DCON modules. The DCON.DLL Driver has now been included in the Libi8k.a library.

Functions (3) in the diagram contains the most important functions, as they are especially designed for I-8000 modules inserted in the LP-8x21 slots. They are different from functions (1) and (2) because the communication method for I-8000 modules inserted in the LP-8x21 is based on parallel mode rather than serial mode. Accordingly, the I8000.c library has been completely rewritten especially for I-8000 modules inserted in LP-8x21 slots and has been renamed as slot.c. The following is an introduction to the functions for slot.c, which can be arranged into eight main categories:

1. System Information Functions
2. Digital Input/Output Functions
3. Analog Input Functions
4. Analog Output Functions
5. 3-axis Encoder Functions
6. 2-axis Stepper/Servo Functions

Note that when using a development tool to create develop applications, the **msw.h** file must be included in the header of the source program, and the **Libi8k.a** library file must also be linked. To control ICP DAS remote I/O modules such as the I-7K, I-8K and I-87K series modules **via the COM2 or COM3 or COM4 ports on the LP-8x21**, the functions are the same as those included in the DCON DLL. To control **I-8K series modules** that are inserted in the slots of the LP-8x21, the functions are different and they are described in more detail below:

6.1 System Information Functions

■ Open_Slot

Description:

This function is used to open and initialize a specific slot on the LP-8x21, and will be used by I-8K or I-87K modules inserted in the LP-8x21. For example, to send or receive data from a specific slot, this function must be called first before any other functions can be used.

Syntax:

```
int Open_Slot(int slot) [ C ]
```

Parameter:

slot : [Input] Specifies the slot where the I/O module is inserted.

Return Values:

0: The slot was successfully initialized.

Other: The initialization failed.

Refer to Chapter 6.7: "Error Code Definitions" for details of other returned values.

Example:

```
Int slot=1;  
Open_Slot(slot);  
// The first slot in the LP-8x21 will be open and initiated.
```

■ Close_Slot

Description:

After using the of `Open_Slot()` function to open and initialize a specific slot on the LP-8x21, the `Close_Slot()` function must also be used to close the slot. This function will be used by I-8K or I-87K series modules inserted in the LP-8x21. For example, the `Close_Slot()` function should be called after sending or receiving data from the specified slot.

Syntax:

```
void Close_Slot(int slot) [ C ]
```

Parameter:

slot : [Input] Specifies the slot where the I/O module is inserted.

Return Value:

None

Examples:

```
int slot=1;  
Close_Slot(slot);  
// The first slot in the LP-8x21 will be closed.
```

Remark:

■ Open_SlotAll

Description:

This function is used to open and initialize **all slots** on the LP-8x21. For example, to send or receive data from multiple slots, this function can be used to simplify the program, and other functions can be used.

Syntax:

[C]
<code>int Open_SlotAll(void)</code>

Parameter:

None

Return Value:

0: The slot was successfully initialized.

Other: The initialization failed.

Refer to Chapter 6.7: "Error Code Definitions" for details of other returned values.

Examples:

```
Open_SlotAll();  
// All slots in the LP-8x21 will be open and initiated.
```

Remark:

■ Close_SlotAll

Description:

If you the Open_SlotAll() function was used to open and initialize all the slots on the LP-8x21, the Close_SlotAll() function can be used to quickly close them simultaneously. For example, the Close_SlotAll() function can be called after sending or receiving data from multiple slots to close all the slots at the same time.

Syntax:

[C]
<code>void Close_SlotAll(void)</code>

Parameter:

None

Return Value:

None

Examples:

```
Close_Slot();  
// All slots in the LP-8x21 will be closed.
```

Remark:

■ ChangeToSlot

Description:

This function is used to assign serial control to the specified slots for to allow control of the I-87K series. The serial bus on the backplane of the LP-8x21 is used for mapping through to COM1. For example, to send or receive data from a specified slot, this function should be called first, and then other series functions can be used.

Syntax:

[C]
<code>void ChangeToSlot(char slot)</code>

Parameter:

slot : [Input] Specifies the slot where the I/O module is inserted.

Return Value:

None

Examples:

```
char slot=2;
ChangeToSlot (slot);
// The first slot on the LP-8x21 is specified as the COM1 port.
```

Remark:

■ Open_Com

Description:

This function is used to open and configure the COM port, and must be **called at least once before** sending/receiving a command via the COM port. For example, to send or receive data from a specified COM port, this function should be called first, and then other series functions can be used.

Syntax:

[C]
<code>WORD Open_Com(char port, DWORD baudrate, char cData, char cParity, char cStop)</code>

Parameter:

port : [Input] COM1, COM2, COM3..., COM255.
baudrate: [Input] 1200/2400/4800/9600/19200/38400/57600/115200
cDate : [Input] Data5Bit, Data6Bit, Dat7Bit, Data8Bit
cParity : [Input] NonParity, OddParity, EvenParity
cStop : [Input] OneStopBit, TwoStopBit

Return Values:

0: The com port was successfully initialized.

Other: The initialization failed.

Refer to Chapter 6.7: "Error Code Definitions" for details of other returned values.

Examples:

```
Open_Com(COM3, 9600, Data8Bit, NonParity, OneStopBit);
```

Remark:

■ Close_Com

Description:

This function is used to closes and releases the resources of the COM port computer recourse. And it must be **called before exiting the application program**. The Open_Com will return error message if the program exit without calling Close_Com function.

Syntax:

[C]
BOOL Close_Com(char port)

Parameter:

port : [Input] COM1,COM2, COM3...COM255.

Return Value:

None

Example:

```
Close_Com (COM3);
```

Remark:

■ Send_Receive_Cmd

Description:

This function is used to send a command string to RS-485 network and receive the response from RS-485 network. If the `wChkSum=1`, this function automatically adds the two checksum bytes into the command string and also check the checksum status when receiving response from the modules. Note that the end of sending string is added `[0x0D]` to mean the termination of every command.

Syntax:

```
[ C ]  
WORD Send_Receive_Cmd (char port, char szCmd[ ], char szResult[ ],  
WORD wTimeOut, WORD wChksum, WORD *wT)
```

Parameter:

port : [Input] 1=COM1, 2=COM2, 3=COM3..., 255=COM255.
szCmd: [Input] Sending command string
szResult : [Input] Receiving the response string from the modules
wTimeOut : [Input] Communicating timeout setting, the unit=1ms
wChkSum : [Input] 0=Disable, 1=Enable
*wT: [Output] Total time of send/receive interval, unit=1 ms

Return Value:

0: The function was successfully processed.

Other: The processing failed.

Refer to Chapter 6.7: "Error Code Definitions" for details of other returned values.

Examples:

```
char m_port =1;  
DWORD m_baudrate=115200;  
WORD m_timeout=100;  
WORD m_chksum=0;  
WORD m_wT;  
char m_szSend[40], m_szReceive[40];  
int RetVal;  
m_szSend[0] = '$';  
m_szSend[1] = '0';  
m_szSend[2] = '0';
```

```

m_szSend[3] = 'M';
m_szSend[4] = 0;
/* open device file */
Open_Slot(1);
RetVal = Open_Com(m_port, m_baudrate, Data8Bit, NonParity, OneStopBit);
if (RetVal >0) {
    printf("Open COM%d failed!\n", m_port);
    return FAILURE;
}
RetVal = Send_Receive_Cmd(m_port, m_szSend, m_szReceive, m_timeout,
    m_chksum, &m_wT);
if (RetVal) {
    printf("Module at COM%d Address %d error !!!\n", m_port, m_szSend[2] );
    return FAILURE;
}
Close_Com (m_port);

```

■ Send_Cmd

Description:

This function only sends a command string to DCON series modules. If the wChkSum=1, it automatically **adds the two checksum bytes to the command string**. And then the end of sending string is further added [0x0D] to mean the termination of the command (szCmd). And this command string cannot include space char within the command string. For example: "\$01M 02 03" is user's command string. However, the actual command send out is "\$01M".

Syntax:

[C]
WORD Send_Cmd (char port, char szCmd[], WORD wTimeout, WORD wChksum)

Parameter:

port : [Input] 1=COM1, 2=COM2, 3=COM3..., 255=COM255.
szCmd : [Input] Sending command string
wTimeout : [Input] Communicating timeout setting, the unit=1ms
wChkSum : [Input] 0=Disable, 1=Enable

Return Value:

None

Examples:

```
char m_port=1, m_szSend[40];  
DWORD m_baudrate=115200;  
WORD m_timeout=100, m_chksum=0;  
m_szSend[0] = '$';  
m_szSend[1] = '0';  
m_szSend[2] = '0';  
m_szSend[3] = 'M';  
Open_Slot(2); // The module is inserted in slot 2 and address is 0.  
Open_Com(m_port, m_baudrate, Data8Bit, NonParity, OneStopBit);  
Send_Cmd(m_port, m_szSend, m_timeout, m_chksum);  
Close_Com (m_port);
```

Remark:

■ Receive_Cmd

Description:

This function is used to obtain the responses string from the modules in RS-485 network. And this function provides a response string without the last byte [0x0D].

Syntax:

```
[ C ]  
WORD Receive_Cmd (char port, char szResult[ ], WORD wTimeOut,  
WORD wChksum)
```

Parameter:

port : [Input] 1=COM1, 2=COM2, 3=COM3..., 255=COM255.
szResult : [Output] Sending command string
wTimeOut : [Input] Communicating timeout setting, the unit=1ms
wChkSum : [Input] 0=Disable, 1=Enable

Return Value:

None

Examples:

```
char m_port=3;  
char m_Send[40], m_szResult[40] ;  
DWORD m_baudrate=115200;  
WORD m_timeout=100, m_chksum=0;  
m_szSend[0] = '$';  
m_szSend[1] = '0';  
m_szSend[2] = '1';  
m_szSend[3] = 'M';  
m_szSend[4] = 0;  
Open_Com (m_port, m_baudrate, Data8Bit, NonParity, OneStopBit);  
Send_Cmd (m_port, m_szSend, m_timeout, m_chksum);  
Receive_Cmd (m_port, m_szResult, m_timeout, m_chksum);  
Close_Com (m_port);  
// Read the remote module:I-7016D , m_szResult : "!017016D"
```

Remark:

■ Send_Binary

Description:

Send out the command string by fix length, which is controlled by the parameter "iLen". The difference between this function and Send_cmd is that Send_Binary terminates the sending process by the string length "iLen" instead of the character "CR"(Carry return). Therefore, this function can send out command string with or without null character under the consideration of the command length. Besides, because of this function without any error checking mechanism (Checksum, CRC, LRC... etc.), users have to add the error checking information to the raw data by themselves if communication checking system is required. Note that this function is usually applied to communicate with the other device, but not for ICP DAS DCON (I-7000/8000/87K) series modules.

Syntax:

```
[ C ]  
WORD Send_Binary (char port, char szCmd[ ], int iLen)
```

Parameter:

port : [Input] 1=COM1, 2=COM2, 3=COM3..., 255=COM255.
szCmd : [Input] Sending command string
iLen : [Input] The length of command string.

Return Value:

None

Examples:

```
int m_length=4;  
char m_port=3, char m_szSend[40];  
DWORD m_baudrate=115200;  
m_szSend[0] = '0';  
m_szSend[1] = '1';  
m_szSend[2] = '2';  
m_szSend[3] = '3';  
Open_Com(m_port, m_baudrate, Data8Bit, NonParity, OneStopBit);  
Send_Binary(m_port, m_szSend, m_length);  
Close_Com (m_port);
```

Remark:

■ Receive_Binary

Description:

This function is applied to receive the fix length response. The length of the receiving response is controlled by the parameter "iLen". The difference between this function and Receive_cmd is that Receive_Binary terminates the receiving process by the string length "iLen" instead of the character "CR"(Carry return). Therefore, this function can be used to receive the response string data with or without null character under the consideration of receiving length. Besides, because of this function without any error checking mechanism (checksum, CRC, LRC... etc.), users have to remove from the error checking information from the raw data by themselves if communication checking system is used. Note that this function is usually applied to communicate with the other device, but not for ICP DAS DCON (I-7000/8000/87K) series modules.

Syntax:

```
[ C ]  
WORD Receive_Binary (char cPort, char szResult[], WORD wTimeOut,  
                    WORD wLen, WORD *wT)
```

Parameter:

port : [Input] 1=COM1, 2=COM2, 3=COM3..., 255=COM255.
szResult : [Input] Receiving the response string from the modules
wTimeOut : [Input] Communicating timeout setting, the unit=1ms
wLen : [Input] The length of command string.
*wT: [Output] Total time of send/receive interval, unit=1 ms

Return Value:

None

Examples:

```
int m_length=10;  
char m_port=3;  
char m_szSend[40];  
char m_szReceive[40];  
DWORD m_baudrate=115200;  
WORD m_wt;  
WORD m_timeout=10;
```

```
WORD m_wlength=10;
m_szSend[0] = '0';
m_szSend[1] = '1';
m_szSend[2] = '2';
m_szSend[3] = '3';
m_szSend[4] = '4';
m_szSend[5] = '5';
m_szSend[6] = '6';
m_szSend[7] = '7';
m_szSend[8] = '8';
m_szSend[9] = '9';
Open_Com(m_port, m_baudrate, Data8Bit, NonParity, OneStopBit);
// send 10 character
Send_Binary(m_port, m_szSend, m_length);
// receive 10 character
Receive_Binary( m_port, m_szResult, m_timeout, m_wlength, &m_wt);
Close_Com (m_port);
```

Remark:

■ sio_open

Description:

This function is used to open and initiate a specified serial port in the LP-8x21. The n-port modules in the LP-8x21 will use this function. For example, if you want to send or receive data from a specified serial port, this function must be called first. Then the other functions can be used later.

Syntax:

```
[ C ]  
int sio_open(const char *port, speed_t baudrate, tcflag_t data, tcflag_t parity,  
             tcflag_t stop)
```

Parameter:

port : [Input] device name: /dev/ttyS2, /dev/ttyS3.../dev/ttyS34
baudrate: [Input] B1200/ B2400/ B4800/ B9600/ B19200/ B38400/ B57600/
 B115200
date : [Input] DATA_BITS_5/ DATA_BITS_6/ DATA_BITS_7/ DATA_BITS_8
parity : [Input] NO_PARITY / ODD_PARITY / EVEN_PARITY
stop : [Input] ONE_STOP_BIT / TWO_STOP_BITS

Return Value:

This function returns int port descriptor for the port opened successfully.
ERR_PORT_OPEN is for Failure.

Examples:

```
#define COM_M1 "/dev/ttyS2" // Defined the first port of I-8144W in slot 1  
char fd[5];  
fd[0]=sio_open(COM_M1, B9600, DATA_BITS_8, NO_PARITY, ONE_STOP_BIT);  
if (fd[0] == ERR_PORT_OPEN) {  
    printf("open port_m failed!\n");  
    return (-1);  
}  
// The i8114W is inserted in slot 1 and the first port will be open and initiated.
```

Remark:

This function can be applied on modules: I-8114W, I-8112iW, I-8142iW and I-8144iW.

■ `sio_close`

Description:

If you have used the function of `sio_open()` to open the specified serial port in the LP-8x21, you need to use the `sio_close()` function to close the specified serial port in the LP-8x21. For example, once you have finished sending or receiving data from a specified serial port, this function would then need to be called.

Syntax:

```
int sio_close(int port) [ C ]
```

Parameter:

port : [Input] device name: /dev/ttyS2, /dev/ttyS3.../dev/ttyS34

Return Value:

None

Examples:

```
#define COM_M2 "/dev/ttyS3" // Defined the second port of I-8144iW in slot 1
char fd[5];
fd[0]=sio_open(COM_M2, B9600, DATA_BITS_8, NO_PARITY, ONE_STOP_BIT);
sio_close (fd[0]);
// The second port of i8144iW in slot 1 will be closed.
```

Remark:

This function can be applied on modules: I-8114W, I-8112iW, I-8142iW and I-8144iW.

■ GetModuleType

Description:

This function is used to retrieve which type of 8000 series I/O module is inserted in a specific I/O slot in the LP-8x21. This function performs a supporting task in the collection of information related to the system's hardware configurations.

Syntax:

```
[ C ]  
  
int GetModuleType(int slot)
```

Parameter:

slot : [Input] Specifies the slot where the I/O module is inserted.

Return Value:

Module Type: it is defined in the **IdTable[]** of slot.c.

Type	Value
PARALLEL	0x80
AI	0xA0
AO	0xA1
DI8	0xB0
DI16	0xB1
DI32	0xB2
DO6	0xC0
DO8	0xC1
DO16	0xC2
DO32	0xC3
DI4DO4	0xD0
DI8DO8	0xD1
DI16DO16	0xD2
MOTION	0xE2
CAN	0XF0

Examples:

```
int slot=1;  
int moduleType;  
Open_Slot(slot);  
printf("GetModuleType= 0x%X \n", GetModuleType(slot));  
Close_Slot(slot);  
// The I-8057W card is inserted in slot 1 of LP-8x21 and has a return Value : 0xC2
```

Remark:

■ GetNameOfModule

Description:

This function is used to retrieve the name of an 8000 series I/O module, which is plugged into a specific I/O slot in the LP-8x21. This function supports the collection of system hardware configurations.

Syntax:

[C]
<code>int GetNameOfModule(int slot)</code>

Parameter:

slot: [Input] Specifies the slot where the I/O module is inserted.

Return Value:

I/O module ID. For Example, the I-8017W will return 8017.

Examples:

```
int slot=1;
int moduleID;
Open_Slot(slot);
moduleID=GetNameOfModule(slot);
Close_Slot(slot);
// The I-8017W module is inserted in slot 1 of LP-8x21.
// Returned Value: moduleName=" 8017 "
```

Remark:

■ Read_SN

Description:

This function is used to retrieve the hardware serial identification number on the LP-8x21 main controller. This function supports the control of hardware versions by reading the serial ID chip

Syntax:

[C]
<code>void read_sn(char sn[])</code>

Parameter:

sn : [Output] Receive the serial ID number.

Return Value:

None

Examples:

```
int rs = 0;
char sn[16];
rs = read_sn(sn);
if(rs)
    printf("read sn fail!\n");
else
    printf("LP-8x21 SN : %s\n", sn);
```

Remark:

■ GetBackPlaneID

Description:

This function is used to retrieve the back plane ID number in the LP-8x21.

Syntax:

```
int GetBackPlaneID() [ C ]
```

Parameter:

None

Return Value:

Backplane ID number.

Examples:

```
int id;  
id=GetBackPlaneID();  
printf("GetBackPlaneID =%d \n", id);  
// Get the LP-8x21 backplane id . Returned Value: GetBackPlaneID = 2
```

Remark:

■ GetSlotCount

Description:

This function is used to retrieve the number of slot in the LP-8x21.

Syntax:

[C]
<code>int GetSlotCount()</code>

Parameter:

None

Return Value:

Number of slot.

Examples:

```
int number;  
number= GetSlotCount();  
printf("GetSlotCount =%d \n", number);  
// Get the LinPAC-8841 slot count.  
// Returned Value: GetSlotCount = 8
```

Remark:

■ GetDIPswitch

Description:

This function is used to retrieve the DIP switch value in the LP-8x21.

Syntax:

[C]
<code>int GetDIPswitch()</code>

Parameter:

None

Return Value:

DIP switch value.

Examples:

```
int value;
value= GetDIPswitch();
printf("GetDIPswitch =%d \n", value);
// Get the LP-8x21 DIP switch value.
// Returned Value: GetDIPswitch = 128
```

Remark:

This function can be applied on PAC: LP-8421, LP-8821.

■ rotary_switch_read

Description:

This function is used to retrieve the rotary ID number in the LP-8x21.

Syntax:

```
[ C ]  
int rotary_switch_read (&value)
```

Parameter:

value: [Output] Rotary switch ID number.

Return Value:

0: The slot was successfully initialized.

Other: The initialization failed.

Refer to Chapter 6.7: "Error Code Definitions" for details of other returned values.

Examples:

```
int result=0 ;  
unsigned char value=0;  
rotary_switch_read (&value);  
if(result)  
{  
    printf("rsw(%d) : rotary switch read error\n",result);  
    return FAILURE;  
}  
else  
{  
    printf("%d\n", value);    //Get the LP-8x21 rotary id  
}
```

If user turn the rotary switch to the 1 position, would get the returned value: 1.

Remark:

Rsw	0	1	2	3	4	5	6	7	8	9
ID	0	1	2	3	4	5	6	7	8	9

■ GetSDKversion

Description:

This function is used to retrieve the version of LP-8x21 SDK.

Syntax:

[C]
<code>float GetSDKversion(void)</code>

Parameter:

None

Return Value:

Version number.

Examples:

```
printf(" GetSDKversion = %4.2f \n ", GetSDKversion());  
// Get the LP-8x21 SDK version number.  
// Returned Value: GetSDKversion = 1.
```

Remark:

6.2 Digital Input/Output Functions

6.2.1 For I-8000 modules via parallel port

■ DO_8

Description:

This function is used to output 8-bit data to a digital output module. The 0 to 7 bits of output data are mapped into the 0 to 7 channels of digital module output respectively.

Syntax:

```
void DO_8(int slot, unsigned char data) [ C ]
```

Parameter:

slot : [Input] Specifies the slot where the I/O module is inserted.
data : [Input] output data.

Return Value:

None

Examples:

```
int slot=1;  
unsigned char data=3;  
DO_8(slot, data);  
// The I-8064W is inserted in slot 1 of LP-8x21 and can turn on channel 0 and 1.
```

Remark:

This function can be applied on modules: I-8060W, I-8064W, I-8065W, I-8066W, I-8068W and I-8069W.

■ DO_16

Description:

This function is used to output 16-bit data to a digital output module. The 0 to 15 bits of output data are mapped into the 0 to 15 channels of digital output modules respectively.

Syntax:

```
[ C ]  
void DO_16(int slot, unsigned int data)
```

Parameter:

slot : [Input] Specifies the slot where the I/O module is inserted..
data : [Input] output data.

Return Value:

None

Examples:

```
int slot=1;  
unsigned int data=3;  
DO_16(slot, data);  
// The I-8057W is inserted in slot 1 of LP-8x21 and can turn on channel 0 and 1.
```

Remark:

This function can be applied on modules: I-8037W, I-8056W, I-8057W and I-8046W.

■ DO_32

Description:

Output the 32-bit data to a digital output module. The 0 to 31 bits of output data are mapped into the 0 to 31 channels of digital output modules respectively.

Syntax:

```
[ C ]  
void DO_32(int slot, unsigned int data)
```

Parameter:

slot : [Input] Specifies the slot where the I/O module is inserted.
data : [Input] output data.

Return Value:

None

Examples:

```
int slot=1;  
unsigned int data=3;  
DO_32(slot, data);  
// The I-8041W is inserted in slot 1 of LP-8x21 and can turn on channel 0 and 1.
```

Remark:

This function can be applied on module: I-8041W.

■ DI_8

Description:

Obtains 8-bit input data from a digital input module. The 0 to 7 bits of input data correspond to the 0 to 7 channels of digital input modules respectively.

Syntax:

```
unsigned char DI_8(int slot) [ C ]
```

Parameter:

slot : [Input] Specifies the slot where the I/O module is inserted.

Return Value:

Input data

Examples:

```
int slot=1;
unsigned char data;
data=DI_8(slot);
// The I-8058W is inserted in slot 1 of LP-8x21 and has inputs in channel 0 and 1.
// Returned value: data=0xfC
```

Remark:

There are two kind of Input type:

Input Type	On State	Off State	Modules
1	LED On, Readback as 1	LED Off, Readback as 0	I-8058W
2	LED On, Readback as 0	LED Off, Readback as 1	I-8048W, I-8052W

■ DI_16

Description:

This function is used to obtain 16-bit input data from a digital input module. The 0 to 15 bits of input data correspond to the 0 to 15 channels of digital module's input respectively.

Syntax:

```
unsigned int DI_16(int slot) [ C ]
```

Parameter:

slot : [Input] Specifies the slot where the I/O module is inserted.

Return Value:

Input data

Examples:

```
int slot=1;
unsigned int data;
data=DI_16(slot);
// The I-8053W is inserted in slot 1 of LP-8x21 and has inputs in channel 0 and 1.
// Returned value: data=0xffc
```

Remark:

There are two kind of Input type:

Input Type	On State	Off State	Modules
1	LED On, Readback as 1	LED Off, Readback as 0	I-8046W
2	LED On, Readback as 0	LED Off, Readback as 1	I-8051W, I-8053W, I-8053PW

■ DI_32

Description:

This function is used to obtain 32-bit input data from a digital input module. The 0 to 31 bits of input data correspond to the 0 to 31 channels of digital input module respectively.

Syntax:

```
unsigned long DI_32(int slot) [ C ]
```

Parameter:

slot : [Input] Specifies the slot where the I/O module is inserted.

Return Value:

Input data

Examples:

```
int slot=1;
unsigned long data;
data=DI_32(slot);
// The I-8040W is inserted in slot 1 of LP-8x21 and has inputs in channels 0 and 1.
// Returned value: data=0xfffffC
```

Remark:

Input Type	On State	Off State	Modules
	LED On, Readback as 0	LED Off, Readback as 1	I-8040W

■ DIO_DO_8

Description:

This function is used to output 8-bit data to DIO modules. These modules run 8 digital input channels and 8 digital output channels simultaneously. The 0 to 7 bits of output data are mapped onto the 0 to 7 output channels for their specific DIO modules respectively.

Syntax:

```
[ C ]  
void DIO_DO_8(int slot, unsigned char data)
```

Parameter:

slot : [Input] Specifies the slot where the I/O module is inserted.
data : [Input] output data.

Return Value:

None

Examples:

```
int slot=1;  
unsigned char data=3;  
DIO_DO_8(slot, data);  
// The I-8054W is inserted in slot 1 of LP-8x21 and can turn on channels 0 and 1.  
// It not only outputs a value, but also shows 16LEDs.
```

Remark:

This function can be applied in modules: I-8054W, I-8055W, and I-8063W.

■ DIO_DO_16

Description:

This function is used to output 16-bits of data to DIO modules, which have 16 digital input and 16 digital output channels running simultaneously. The 0 to 15 bits of output data are mapped onto the 0 to 15 output channels for their specific DIO modules respectively.

Syntax:

```
[ C ]  
void DIO_DO_16(int slot, unsigned int data)
```

Parameter:

slot : [Input] Specifies the slot where the I/O module is inserted.
data : [Input] output data.

Return Value:

None

Examples:

```
int slot=1;  
unsigned int data=3;  
DIO_DO_16(slot, data);  
// The I-8042W is inserted in slot 1 of LP-8x21 and can turn on the channels 0 and 1.  
// It not only outputs a value, but also shows 32LEDs.
```

Remark:

This function can be applied on modules: I-8042W and I-8050W.

■ DIO_DI_8

Description:

This function is used to obtain 8-bit data from DIO modules. These modules run 8 digital input and 8 digital output channels simultaneously. The 0 to 7 bits of input data, are mapped onto the 0 to 7 input channels for their specific DIO modules respectively.

Syntax:

[C]
Unsigned char DIO_DI_8(int slot)

Parameter:

slot : [Input] Specifies the slot where the I/O module is inserted.

Return Value:

Input data

Examples:

```
int slot=1;
unsigned char data;
data=DIO_DI_8(slot);
// The I-8054W is inserted in slot 1 of LP-8x21 and has inputs in channel 0 and 1.
// Returned value: data=0xfC
```

Remark:

This function can be applied in modules: I-8054W, I-8055W and I-8063W.

■ DIO_DI_16

Description:

This function is used to obtain 16-bit data from DIO modules. These modules run 16 digital input and 16 digital output channels simultaneously. The 0 to 15 bits of iutput data are mapped onto the 0 to 15 iutput channels for their specific DIO modules respectively.

Syntax:

[C]
Unsigned char DIO_DI_16(int slot)

Parameter:

slot : [Input] Specifies the slot where the I/O module is inserted.

Return Value:

Input data

Examples:

```
int slot=1;
unsigned char data;
data=DIO_DI_16(slot);
// The I-8042W is inserted in slot 1 of LP-8x21 and has inputs in channel 0 and 1.
// Returned value: data=0xffC
```

Remark:

This function can be applied in modules: I-8042W.

■ DO_8_RB 、 DO_16_RB 、 DO_32_RB
DIO_DO_8_RB 、 DIO_DO_16_RB

Description:

This function is used to **Readback** all channel status from a Digital Output module.

Syntax:

```
[ C ]  
  
unsigned char DO_8_RB(int slot)  
unsigned int DO_16_RB(int slot)  
unsigned long DO_32_RB(int slot)  
unsigned char DIO_DO_8_RB(int slot)  
unsigned int DIO_DO_16_RB(int slot)
```

Parameter:

slot : [Input] Specifies the slot where the I/O module is inserted.

Return Value:

all DO channel status

Examples:

```
int slot=1;  
Open_Slot(slot);  
printf("%u",DO_32_RB(slot));  
Close_Slot(slot);  
// The I-8041W module is inserted in slot 1 of LP-8x21 and return all DO channel status.
```

Remark:

These functions can be applied on modules:

DO 8 channel: I-8060W, I-i8064W, I-8065W, I-8066W, I-8068W and I-8069W.

DO 16 channel: I-8037W, I-8056W, I-8057W and I-8046W.

DO 32 channel: I-8041W

■ DO_8_BW、DO_16_BW、DO_32_BW DIO_DO_8_BW、DIO_DO_16_BW

Description:

This function is used to output **assigned single channel** status (ON / OFF) of a Digital Output module.

Syntax:

```
[ C ]  
void DO_8_BW(int slot, int bit, int data)  
void DO_16_BW (int slot, int bit, int data)  
void DO_32_BW (int slot, int bit, int data)  
void DIO_DO_8_BW (int slot, int bit, int data)  
void DIO_DO_16_BW (int slot, int bit, int data)
```

Parameter:

- slot : [Input] Specifies the slot where the I/O module is inserted.
- bit : [Input] channel of module.
- data : [Input] channel status [on(1) / off(0)].

Return Value:

None

Examples:

```
int slot=1, bit=0, data=1;  
Open_Slot(slot);  
DO_32_BW(slot, bit, data);  
Close_Slot(slot);  
// The I-8041W module is inserted in slot 1 of LP-8x21 and just turn on channel 0 of  
I-8041W.
```

Remark:

- These functions can be applied on modules:
DO 8 channel: I-8060W, I-8064W, I-8065W, I-8066W, I-8068W and I-8069W.
DO 16 channel: I-i8037W, I-8056W and I-8057W
DO 32 channel: I-8041W

■ DI_8_BW、DI_16_BW、DI_32_BW

Description:

This function is used to **Readback assigned single channel** status (ON / OFF) from a Digital Input module.

Syntax:

```
[ C ]  
  
int DI_8_BW(int slot, int bit)  
int DI_16_BW (int slot, int bit)  
int DI_32_BW (int slot, int bit)
```

Parameter:

slot : [Input] Specifies the slot where the I/O module is inserted.
bit : [Input] channel of module.

Return Value:

None

Examples:

```
int slot=1, bit=0;  
Open_Slot(slot);  
printf("DI channel %d = %d\n", bit, DI_32_BW(slot, bit));  
Close_Slot(slot);  
// The I-8040W module is inserted in slot 1 of LP-8x21 and return channel 0 status ( 0:  
ON ; 1: OFF ).
```

Remark:

These functions can be applied on modules:
DI 8 channel: I-8048W, I-8052W and I-8058W.
DI 16 channel: I-8051W and I-8053W
DI 32 channel: I-8040W

■ UDIO_WriteConfig_16

Description:

This function is used to configure the channel of the universal DIO module which is digital input or digital output mode. The universal DIO module can be up to 16 digital input or digital output channels running simultaneously.

Syntax:

```
[ C ]  
unsigned short UDIO_WriteConfig_16(int slot, unsigned short config)
```

Parameter:

slot : [Input] Specifies the slot where the I/O module is inserted.
config : [Input] channel status.[DO : 1 / DI : 0]

Return Value:

None

Examples:

```
int slot=1;  
unsigned short config=0xffff;  
UDIO_WriteConfig_16(slot, config);  
// The I-8064W is inserted in slot 1 of LP-8x21.  
// WriteConfig: 0xffff (ch 0 to ch15 is DO mode)
```

Remark:

This function can be applied on modules: I-8050W.

■ UDIO_ReadConfig_16

Description:

This function is used to read the channels configuration of the universal DIO module which is digital input or digital output mode.

Syntax:

```
[ C ]  
unsigned short UDIO_ReadConfig_16(int slot)
```

Parameter:

slot : [Input] Specifies the slot where the I/O module is inserted.

Return Value:

None

Examples:

```
int slot=1;  
unsigned int ret;  
unsigned short config=0x0000;  
UDIO_WriteConfig_16(slot, config);  
ret=UDIO_ReadConfig_16(slot);  
printf("Read the I/O Type is : 0x%04lx \n\r",ret);  
// The I-8050W is inserted in slot 1 of LP-8x21.  
// WriteConfig: 0x0000 (ch 0 to ch15 is DI mode)  
// Read the I/O Type is: 0x0000
```

Remark:

This function can be applied on modules: I-8050W.

■ UDIO_DO16

Description:

This function is used to output 0 to 15 bits data to a universal DIO module according to the channel configuration. The 0 to 15 bits of output data are mapped onto the 0 to 15 output channels for their specific universal DIO modules respectively.

Syntax:

```
[ C ]  
void UDIO_DO16(int slot, unsigned short config)
```

Parameter:

slot : [Input] Specifies the slot where the I/O module is inserted.
config : [Input] output data.

Return Value:

None

Examples:

```
int slot=1;  
unsigned int data;  
unsigned short config =0x00ff;  
UDIO_WriteConfig_16(slot, config);  
scanf("%d:",&data);  
UDIO_DO16(slot, data);  
printf("DO(Ch0 to Ch7) of I-8050 in Slot %d = 0x%x\n\r",slot, data);  
// The I-8050W is inserted in slot 1 of LP-8x21  
// WriteConfig: 0x00ff (ch0 to ch7 is DO mode and ch8 to ch15 is DI mode)  
// Input DO value: 255  
// DO(Ch0 to Ch7) of I-8050 in Slot 1 = 0xff
```

Remark:

This function can be applied on modules: I-8050W.

■ UDIO_DI16

Description:

This function is used to input 0 to 15 bits data to a universal DIO module according to the channel configuration. The 0 to 15 bits of input data are mapped onto the 0 to 15 input channels for their specific universal DIO modules respectively.

Syntax:

```
                                [ C ]  
unsigned short UDIO_DI16(int slot)
```

Parameter:

slot : [Input] Specifies the slot where the I/O module is inserted.

Return Value:

None

Examples:

```
int slot=1;  
unsigned int data;  
unsigned short config =0xff00;  
UDIO_WriteConfig_16(slot, config);  
data=UDIO_DI16(slot);  
printf("DI(Ch0 to Ch7) of I-8055 in Slot %d = 0x%x\n\r",slot, data);  
scanf("%d:",&data);  
UDIO_DO16(slot, data);  
printf("DO(Ch8 to Ch15) of I-8050 in Slot %d = 0x%x\n\r",slot, data);  
// The I-8050W is inserted in slot 1 of LP-8x21.  
// WriteConfig: 0xff00 (ch0 to ch7 is DI mode and ch8 to ch15 is DO mode)  
// DI(Ch0 to Ch7) of I-8055 in Slot 1 = 0xfbff  
// Input DO value: 255  
// DO(Ch8 to Ch15) of I-8050 in Slot 1 = 0xff
```

Remark:

This function can be applied on modules: I-8050W.

6.2.2 For I-7000/I-8000/I-87000 modules via serial port

6.2.2.1 I-7000 series modules

■ DigitalOut

Description:

This function is used to output the value of the digital output module for I-7000 series modules.

Syntax:

```
[ C ]  
WORD DigitalOut(WORD wBuf[], float fBuf[], char szSend[], char szReceive[])
```

Parameter:

wBuf: WORD Input/Output argument talbe
wBuf[0] : [Input] COM port number, from 1 to 255
wBuf[1] : [Input] Module address, form 0x00 to 0xFF
wBuf[2] : [Input] Module ID, 0x7011/12/14/42/43/44/50/60/63/65/66/67/80
wBuf[3] : [Input] 0= Checksum disable; 1= Checksum enable
wBuf[4] : [Input] Timeout setting , normal=100 milliseconds
wBuf[5] : [Input] 16-bit digital output data
wBuf[6] : [Input] 0 → no save to szSend &szReceive
 1 → Save to szSend &szReceive
fBuf : Not used.
szSend : [Input] Command string to be sent to I-7000 series modules.
szReceive : [Output] Result string receiving from I-7000 series modules .

Return Value:

0: The function was successfully processed.

Other: The processing failed.

Refer to Chapter 6.7: “Error Code Definitions” for details of other returned values.

Example:

```
char szSend[80];  
char szReceive[80];  
float fBuf[12];  
WORD wBuf[12];  
WORD m_port=3;
```

```

WORD m_address=1;
WORD m_timeout=100;
WORD m_checksum=0;
Open_Com(COM3, 9600, Data8Bit, NonParity, OneStopBit);
wBuf[0] = m_port;
wBuf[1] = m_address;
wBuf[2] = 0x7050;
wBuf[3] = m_checksum;
wBuf[4] = m_timeout;
wBuf[5] = 0x0f;           // 8 DO Channels On
wBuf[6] = 0;
DigitalOut(wBuf, fBuf, szSend, szReceive);
Close_Com(COM3);

```

Remark:

■ DigitalBitOut

Description:

This function is used to set digital output value of the channel No. of I-7000 series modules. The output value is “0” or “1”.

Syntax:

[C]
WORD DigitalBitOut(WORD wBuf[], float fBuf[], char szSend[], char szReceive[])

Parameter:

wBuf: WORD Input/Output argument talbe

wBuf[0] : [Input] COM port number, from 1 to 255

wBuf[1] : [Input] Module address, form 0x00 to 0xFF

wBuf[2] : [Input] Module ID, 0x7042/43/44/50/60/63/65/66/67

wBuf[3] : [Input] 0= Checksum disable; 1= Checksum enable

wBuf[4] : [Input] Timeout setting , normal=100 milliseconds

wBuf[5] : Not used
wBuf[6] : [Input] 0 → no save to szSend &szReceive
 1 → Save to szSend &szReceive
wBuf[7] : [Input] The digital output channel No.
wBuf[8] : [Input] Logic value(0 or 1)
fBuf : Not used.
szSend : [Input] Command string to be sent to I-7000 series modules.
szReceive : [Output] Result string receiving from I-7000 series modules .

Return Value:

0: The function was successfully processed.

Other: The processing failed.

Refer to Chapter 6.7: “Error Code Definitions” for details of other returned values.

Example:

```
char szSend[80];
char szReceive[80];
float fBuf[12];
WORD wBuf[12];
WORD m_port=3;
WORD m_address=1;
WORD m_timeout=100;
WORD m_checksum=0;
Open_Com(COM3, 9600, Data8Bit, NonParity, OneStopBit);
wBuf[0] = m_port;
wBuf[1] = m_address;
wBuf[2] = 0x7065;
wBuf[3] = m_checksum;
wBuf[4] = m_timeout;
wBuf[6] = 0;
wBuf[7] = 0x08;           //RL4 relay On
wBuf[8] = 1;
DigitalBitOut (wBuf, fBuf, szSend, szReceive);
Close_Com(COM3);
```

Remark:

■ DigitalOutReadBack

Description:

This function is used to read back the digital output value of I-7000 series modules.

Syntax:

```
[ C ]  
WORD DigitalOutReadBack(WORD wBuf[ ], float fBuf[ ],char szSend[ ],  
                        char szReceive[ ])
```

Parameter:

wBuf: WORD Input/Output argument talbe
wBuf[0] : [Input] COM port number, from 1 to 255
wBuf[1] : [Input] Module address, form 0x00 to 0xFF
wBuf[2] : [Input] Module ID, 0x7042/43/44/50/60/63/65/66/67/80
wBuf[3] : [Input] 0=Checksum disable; 1=Checksum enable
wBuf[4] : [Input] Timeout setting , normal=100 milliseconds
wBuf[5] : [Output] 16-bit digital output data read back
wBuf[6] : [Input] 0 → no save to szSend &szReceive
 1 → Save to szSend &szReceive
fBuf : Not used.
szSend : [Input] Command string to be sent to I-7000 series modules.
szReceive : [Output] Result string receiving from I-7000 series modules .

Return Value:

0: The function was successfully processed.

Other: The processing failed.

Refer to Chapter 6.7: "Error Code Definitions" for details of other returned values.

Example:

```
char szSend[80];  
char szReceive[80];  
float fBuf[12];  
WORD DO;  
WORD wBuf[12];  
WORD m_port=3;  
WORD m_address=1;  
WORD m_timeout=100;  
WORD m_checksum=0;  
Open_Com(COM3, 9600, Data8Bit, NonParity, OneStopBit);
```

```

wBuf[0] = m_port;
wBuf[1] = m_address;
wBuf[2] = 0x7050;
wBuf[3] = m_checksum;
wBuf[4] = m_timeout;
wBuf[6] = 0;
DigitalOutReadBack (wBuf, fBuf, szSend, szReceive);
DO=wBuf[5];
Close_Com(COM3);

```

Remark:

■ **DigitalOut_7016**

Description:

This function is used to set the digital output value of the specified channel No. of I-7016 module. If the parameter of wBuf[7] is “0”, it means to output the digital value through Bit0 and Bit1 digital output channels. If wBuf[7] is “1”, it means to output the digital value through Bit2 and Bit3 digital output channels.

Syntax:

[C]

WORD DigitalOut_7016(WORD wBuf[], float fBuf[], char szSend[], char szReceive[])

Parameter:

wBuf: WORD Input/Output argument talbe

wBuf[0] : [Input] COM port number, from 1 to 255

wBuf[1] : [Input] Module address, form 0x00 to 0xFF

wBuf[2] : [Input] Module ID, 0x7016

wBuf[3] : [Input] 0= Checksum disable; 1= Checksum enable

wBuf[4] : [Input] Timeout setting , normal=100 milliseconds
wBuf[5] : [Input] 2-bit digital output data in decimal format
wBuf[6] : [Input] 0 → no save to szSend &szReceive
 1 → Save to szSend &szReceive
wBuf[7] : [Input] 0 : Bit0, Bit1 output
 1 : Bit2, Bit3 output
fBuf : Not used.
szSend : [Input] Command string to be sent to I-7000 series modules.
szReceive : [Output] Result string receiving from I-7000 series modules .

Return Value:

0: The function was successfully processed.

Other: The processing failed.

Refer to Chapter 6.7: “Error Code Definitions” for details of other returned values.

Examples:

```
char szSend[80];
char szReceive[80];
float fBuf[12];
WORD wBuf[12];
WORD m_port=3;
WORD m_address=1;
WORD m_timeout=100;
WORD m_checksum=0;
Open_Com(COM3, 9600, Data8Bit, NonParity, OneStopBit);
wBuf[0] = m_port;
wBuf[1] = m_address;
wBuf[2] = 0x7016;
wBuf[3] = m_checksum;
wBuf[4] = m_timeout;
wBuf[5] = 1;
wBuf[6] = 0;
wBuf[7] = 1; // Set the Bit2, Bit3 digital output
DigitalOut_7016(wBuf, fBuf, szSend, szReceive);
Close_Com(COM3);
```

Remark:

■ DigitalIn

Description:

This function is used to obtain the digital input value from I-7000 series modules.

Syntax:

```
[ C ]  
WORD DigitalIn(WORD wBuf[], float fBuf[], char szSend[], char szReceive[])
```

Parameter:

wBuf: WORD Input/Output argument talbe
wBuf[0] : [Input] COM port number, from 1 to 255
wBuf[1] : [Input] Module address, form 0x00 to 0xFF
wBuf[2] : [Input] Module ID, 0x7041/44/50/52/53/55/58/60/63/65
wBuf[3] : [Input] 0= Checksum disable; 1= Checksum enable
wBuf[4] : [Input] Timeout setting , normal=100 milliseconds
wBuf[5] : [Output] 16-bit digital output data
wBuf[6] : [Input] 0 → no save to szSend &szReceive
 1 → Save to szSend &szReceive
fBuf : Not used.
szSend : [Input] Command string to be sent to I-7000 series modules.
szReceive : [Output] Result string receiving from I-7000 series modules .

Return Value:

0: The function was successfully processed.

Other: The processing failed.

Refer to Chapter 6.7: "Error Code Definitions" for details of other returned values.

Examples:

```
char szSend[80];  
char szReceive[80];  
float fBuf[12];  
WORD DI;  
WORD wBuf[12];  
WORD m_port=3;  
WORD m_address=1;  
WORD m_timeout=100;  
WORD m_checksum=0;  
Open_Com(COM3, 9600, Data8Bit, NonParity, OneStopBit);  
wBuf[0] = m_port;
```

```

wBuf[1] = m_address;
wBuf[2] = 0x7050;
wBuf[3] = m_checksum;
wBuf[4] = m_timeout;
wBuf[6] = 0;
DigitalIn(wBuf, fBuf, szSend, szReceive);
DI=wBuf[5];
Close_Com(COM3);

```

Remark:

■ DigitalInLatch

Description:

This function is used to obtain the latch value of the high or low latch mode of digital input module.

Syntax:

[C]
WORD DigitalInLatch(WORD wBuf[], float fBuf[], char szSend[], char szReceive[])

Parameter:

wBuf: WORD Input/Output argument talbe

wBuf[0] : [Input] COM port number, from 1 to 255

wBuf[1] : [Input] Module address, form 0x00 to 0xFF

wBuf[2] : [Input] Module ID, 0x7041/44/50/52/53/55/58/60/63/65/66

wBuf[3] : [Input] 0= Checksum disable; 1= Checksum enable

wBuf[4] : [Input] Timeout setting , normal=100 milliseconds

wBuf[5] : [Input] 0: low Latch mode ; 1:high Latch mode

wBuf[6] : [Input] 0 → no save to szSend &szReceive
1 → Save to szSend &szReceive

wBuf[7] : [Output] Latch value
fBuf : Not used.
szSend : [Input] Command string to be sent to I-7000 series modules.
szReceive : [Output] Result string receiving from I-7000 series modules .

Return Value:

0: The function was successfully processed.

Other: The processing failed.

Refer to Chapter 6.7: “Error Code Definitions” for details of other returned values.

Example:

```
char szSend[80];  
char szReceive[80];  
float fBuf[12];  
WORD wBuf[12];  
WORD m_port=3;  
WORD m_address=1;  
WORD m_timeout=100;  
WORD m_checksum=0;  
Open_Com(COM3, 9600, Data8Bit, NonParity, OneStopBit);  
wBuf[0] = m_port ;  
wBuf[1] = m_address ;  
wBuf[2] = 0x7050;  
wBuf[3] = m_checksum ;  
wBuf[4] = m_timeout ;  
wBuf[5] = 1;      // Set the high Latch mode  
wBuf[6] = 0;  
wBuf[7] = 0x03;  // Set the Latch value  
DigitalInLatch(wBuf, fBuf, szSend, szReceive);  
Close_Com(COM3);
```

Remark:

■ ClearDigitalInLatch

Description:

This function is used to clear the latch status of digital input module when latch function has been enable.

Syntax:

```
[ C ]  
WORD ClearDigitalInLatch(WORD wBuf[], float fBuf[],char szSend[],  
char szReceive[])
```

Parameter:

wBuf: WORD Input/Output argument talbe
wBuf[0] : [Input] COM port number, from 1 to 255
wBuf[1] : [Input] Module address, form 0x00 to 0xFF
wBuf[2] : [Input] Module ID, 0x7011/12/14/42/43/44/50/55/58/60/63/65/66/67
wBuf[3] : [Input] 0= Checksum disable; 1= Checksum enable
wBuf[4] : [Input] Timeout setting , normal=100 milliseconds
wBuf[5] : Not used.
wBuf[6] : [Input] 0 → no save to szSend &szReceive
1 → Save to szSend &szReceive
fBuf : Not used.
szSend : [Input] Command string to be sent to I-7000 series modules.
szReceive : [Output] Result string receiving from I-7000 series modules .

Return Value:

0: The function was successfully processed.

Other: The processing failed.

Refer to Chapter 6.7: "Error Code Definitions" for details of other returned values.

Example:

```
char szSend[80];  
char szReceive[80];  
float fBuf[12];  
WORD wBuf[12];  
WORD m_port=3;  
WORD m_address=1;  
WORD m_timeout=100;  
WORD m_checksum=0;
```

```

Open_Com(COM3, 9600, Data8Bit, NonParity, OneStopBit);
wBuf[0] = m_port;
wBuf[1] = m_address;
wBuf[2] = 0x7050;
wBuf[3] = m_checksum;
wBuf[4] = m_timeout;
wBuf[6] = 0;
ClearDigitalInLatch(wBuf, fBuf, szSend, szReceive);
Close_Com(COM3);

```

Remark:

■ **DigitalInCounterRead**

Description:

This function is used to obtain the counter event value of the channel number of digital input module.

Syntax:

[C]

WORD DigitalInCounterRead(**WORD** wBuf[], float fBuf[], char szSend[],
char szReceive[])

Parameter:

- wBuf: WORD Input/Output argument talbe
- wBuf[0] : [Input] COM port number, from 1 to 255
- wBuf[1] : [Input] Module address, form 0x00 to 0xFF
- wBuf[2] : [Input] Module ID, 0x7041/44/50/51/52/53/55/58/60/63/65
- wBuf[3] : [Input] 0= Checksum disable; 1= Checksum enable
- wBuf[4] : [Input] Timeout setting , normal=100 milliseconds

wBuf[5] : [Input] The digital input Channel No.
wBuf[6] : [Input] 0 → no save to szSend &szReceive
 1 → Save to szSend &szReceive
wBuf[7] : [Output] Counter value of the digital input channel No.
fBuf : Not used.
szSend : [Input] Command string to be sent to I-7000 series modules.
szReceive : [Output] Result string receiving from I-7000 series modules .

Return Value:

0: The function was successfully processed.

Other: The processing failed.

Refer to Chapter 6.7: “Error Code Definitions” for details of other returned values.

Example:

```
char szSend[80];
char szReceive[80];
float fBuf[12];
WORD DI_counter;
WORD wBuf[12];
WORD m_port=3;
WORD m_address=1;
WORD m_timeout=100;
WORD m_checksum=0;
Open_Com(COM3, 9600, Data8Bit, NonParity, OneStopBit);
wBuf[0] = m_port;
wBuf[1] = m_address;
wBuf[2] = 0x7050;
wBuf[3] = m_checksum;
wBuf[4] = 100;
wBuf[5] = 0;           // Set the digital input channel No.
wBuf[6] = 0;
DigitalInCounterRead(wBuf, fBuf, szSend, szReceive);
DI_counter=wBuf[7];
Close_Com(COM3);
```

Remark:

■ ClearDigitalInCounter

Description:

This function is used to clear the counter value of the channel number of digital input module.

Syntax:

```
[ C ]  
WORD ClearDigitalInCounter(WORD wBuf[], float fBuf[],char szSend[],  
                           char szReceive[])
```

Parameter:

wBuf: WORD Input/Output argument talbe
wBuf[0] : [Input] COM port number, from 1 to 255
wBuf[1] : [Input] Module address, form 0x00 to 0xFF
wBuf[2] : [Input] Module ID, 0x7041/44/50/51/52/53/55/58/60/63/65
wBuf[3] : [Input] 0= Checksum disable; 1= Checksum enable
wBuf[4] : [Input] Timeout setting , normal=100 milliseconds
wBuf[5] : [Input] The digital input channel No.
wBuf[6] : [Input] 0 → no save to szSend &szReceive
 1 → Save to szSend &szReceive
fBuf : Not used.
szSend : [Input] Command string to be sent to I-7000 series modules.
szReceive : [Output] Result string receiving from I-7000 series modules .

Return Value:

0: The function was successfully processed.

Other: The processing failed.

Refer to Chapter 6.7: "Error Code Definitions" for details of other returned values.

Example:

```
char szSend[80];  
char szReceive[80];  
float fBuf[12];  
WORD wBuf[12];  
WORD m_port=3;  
WORD m_address=1;  
WORD m_timeout=100;  
WORD m_checksum=0;
```

```

Open_Com(COM3, 9600, Data8Bit, NonParity, OneStopBit);
wBuf[0] = m_port;
wBuf[1] = m_address;
wBuf[2] = 0x7050;
wBuf[3] = m_checksum;
wBuf[4] = m_timeout;
wBuf[5] = 0;           // Set the digital input channel No.
wBuf[6] = 0;
ClearDigitalInCounter(wBuf, fBuf, szSend, szReceive);
Close_Com(COM3);

```

Remark:

■ ReadEventCounter

Description:

This function is used to obtain the value of event counter of I-7000 series modules. This function only supports I-7011, I-7012, I-7014 and I-7016 modules.

Syntax:

[C]

WORD ReadEventCounter(WORD wBuf[], float fBuf[],char szSend[],char szReceive[])

Parameter:

wBuf:	WORD Input/Output argument talbe
wBuf[0] :	[Input] COM port number, from 1 to 255
wBuf[1] :	[Input] Module address, form 0x00 to 0xFF
wBuf[2] :	[Input] Module ID, 0x7011/12/14/16
wBuf[3] :	[Input] 0= Checksum disable; 1= Checksum enable
wBuf[4] :	[Input] Timeout setting , normal=100 milliseconds
wBuf[5] :	Not used

wBuf[6] : [Input] 0 → no save to szSend &szReceive
 1 → Save to szSend &szReceive
wBuf[7] : [Output] The value of event counter
fBuf : Not used.
szSend : [Input] Command string to be sent to I-7000 series modules.
szReceive : [Output] Result string receiving from I-7000 series modules .

Return Value:

0: The function was successfully processed.

Other: The processing failed.

Refer to Chapter 6.7: “Error Code Definitions” for details of other returned values.

Example:

```
char szSend[80];
char szReceive[80];
float fBuf[12];
WORD Counter;
WORD wBuf[12];
WORD m_port=3;
WORD m_address=1;
WORD m_timeout=100;
WORD m_checksum=0;
Open_Com(COM3, 9600, Data8Bit, NonParity, OneStopBit);
wBuf[0] = m_port;
wBuf[1] = m_address;
wBuf[2] = 0x7012;
wBuf[3] = m_checksum;
wBuf[4] = m_timeout;
wBuf[6] = 0;
ReadEventCounter (wBuf, fBuf, szSend, szReceive);
Counter=wBuf[7];
Close_Com(COM3);
```

Remark:

■ ClearEventCounter

Description:

This function is used to clear the value of event counter of I-7000 series modules. This function only supports I-7011, I-7012, I-7014 and I-7016 modules.

Syntax:

```
[ C ]  
WORD ClearEventCounter(WORD wBuf[], float fBuf[], char szSend[],  
                        char szReceive[])
```

Parameter:

wBuf: WORD Input/Output argument talbe
wBuf[0] : [Input] COM port number, from 1 to 255
wBuf[1] : [Input] Module address, form 0x00 to 0xFF
wBuf[2] : [Input] Module ID, 0x7011/12/14/16
wBuf[3] : [Input] 0= Checksum disable; 1= Checksum enable
wBuf[4] : [Input] Timeout setting , normal=100 milliseconds
wBuf[5] : Not used
wBuf[6] : [Input] 0 → no save to szSend &szReceive
 1 → Save to szSend &szReceive
fBuf : Not used.
szSend : [Input] Command string to be sent to I-7000 series modules.
szReceive : [Output] Result string receiving from I-7000 series modules .

Return Value:

0: The function was successfully processed.

Other: The processing failed.

Refer to Chapter 6.7: "Error Code Definitions" for details of other returned values.

Example:

```
char szSend[80];  
char szReceive[80];  
float fBuf[12];  
WORD wBuf[12];  
WORD m_port=3;  
WORD m_address=1;  
WORD m_timeout=100;  
WORD m_checksum=0;  
Open_Com(COM3, 9600, Data8Bit, NonParity, OneStopBit);
```

```
wBuf[0] = m_port;  
wBuf[1] = m_address;  
wBuf[2] = 0x7012;  
wBuf[3] = m_checksum;  
wBuf[4] = m_timeout;  
wBuf[6] = 0;  
ClearEventCounter (wBuf, fBuf, szSend, szReceive);  
Close_Com(COM3);
```

Remark:

6.2.2.2 I-8000 series modules

■ DigitalOut_8K

Description:

This function is used to set the digital output value of digital output module for I-8000 series modules.

Syntax:

```
[ C ]  
WORD DigitalOut_8K(DWORD dwBuf[], float fBuf[],char szSend[],char szReceive[])
```

Parameter:

dwBuf: WORD Input/Output argument talbe
dwBuf[0] : [Input] COM port number, from 1 to 255
dwBuf[1] : [Input] Module address, form 0x00 to 0xFF
dwBuf[2] : [Input] Module ID, 0x8041/42/54/55/56/57/60/63/64/65/66/67/68/77
dwBuf[3] : [Input] 0= Checksum disable; 1= Checksum enable
dwBuf[4] : [Input] Timeout setting , normal=100 milliseconds
dwBuf[5] : [Input] 16-bit digital output data
dwBuf[6] : [Input] 0 → no save to szSend &szReceive
 1 → Save to szSend &szReceive
dwBuf[7] : [Input] Slot number; the I/O module installed in I-8000 main unit.
fBuf : Not used.
szSend : [Input] Command string to be sent to I-8000 series modules.
szReceive : [Output] Result string receiving from I-8000 series modules .

Return Value:

0: The function was successfully processed.

Other: The processing failed.

Refer to Chapter 6.7: "Error Code Definitions" for details of other returned values.

Example:

```
char szSend[80];  
char szReceive[80];  
float fBuf[12];  
DWORD dwBuf[12];  
DWORD m_port=3;  
DWORD m_slot=1;  
DWORD m_address=1;
```

```

DWORD m_timeout=100;
DWORD m_checksum=0;
Open_Com(COM3, 9600, Data8Bit, NonParity, OneStopBit);
dwBuf[0] = m_port;
dwBuf[1] = m_address;
dwBuf[2] = 0x8041;
dwBuf[3] = m_checksum;
dwBuf[4] = m_timeout;
dwBuf[5] = 10;           // digital output
dwBuf[6] = 0;
dwBuf[7] = m_slot;
DigitalOut_8K(dwBuf, fBuf, szSend, szReceive);
Close_Com(COM3);

```

Remark:

■ DigitalBitOut_8K

Description:

This function is used to set the digital value of the digital output channel No. of I-8000 series modules. The output value is "0" or "1".

Syntax:

[C]

WORD DigitalBitOut_8K(DWORD dwBuf[], float fBuf[], char szSend[], char szReceive[])

Parameter:

dwBuf:	DWORD Input/Output argument talbe
dwBuf[0] :	[Input] COM port number, from 1 to 255
dwBuf[1] :	[Input] Module address, form 0x00 to 0xFF
dwBuf[2] :	[Input] Module ID, 0x8041/42/54/55/56/57/60/63/64/65/66/67/68/77
dwBuf[3] :	[Input] 0= Checksum disable; 1= Checksum enable
dwBuf[4] :	[Input] Timeout setting , normal=100 milliseconds
dwBuf[5] :	[Input] 16-bit digital output data
dwBuf[6] :	[Input] 0 → no save to szSend &szReceive

1 → Save to szSend &szReceive

dwBuf[7] : [Input] Slot number; the I/O module installed in I-8000 main unit.

dwBuf[8] : [Input] The output channel No.

fBuf : Not used.

szSend : [Input] Command string to be sent to I-8000 series modules.

szReceive : [Output] Result string receiving from I-8000 series modules .

Return Value:

0: The function was successfully processed.

Other: The processing failed.

Refer to Chapter 6.7: "Error Code Definitions" for details of other returned values.

Example:

```
char szSend[80];
char szReceive[80];
float fBuf[12];
DWORD dwBuf[12];
DWORD m_port=3;
DWORD m_slot=1;
DWORD m_address=1;
DWORD m_timeout=100;
DWORD m_checksum=0;
Open_Com(COM3, 9600, Data8Bit, NonParity, OneStopBit);
dwBuf[0] = m_port;
dwBuf[1] = m_address;
dwBuf[2] = 0x8041;
dwBuf[3] = m_checksum;
dwBuf[4] = m_timeout;
dwBuf[5] = 10;           // digital output
dwBuf[6] = 0;
dwBuf[7] = m_slot;
dwBuf[8] = 3;
DigitalBitOut_8K(dwBuf, fBuf, szSend, szReceive);
Close_Com(COM3);
```

Remark:

■ DigitalIn_8K

Description:

This function is used to obtain the digital input value from I-8000 series modules.

Syntax:

```
[ C ]  
WORD DigitalIn_8K(DWORD dwBuf[], float fBuf[], char szSend[], char szReceive[])
```

Parameter:

dwBuf: DWORD Input/Output argument talbe
dwBuf[0] : [Input] COM port number, from 1 to 255
dwBuf[1] : [Input] Module address, form 0x00 to 0xFF
dwBuf[2] : [Input] Module ID, 0x8040/42/51/52/54/55/58/63/77
dwBuf[3] : [Input] 0= Checksum disable; 1= Checksum enable
dwBuf[4] : [Input] Timeout setting , normal=100 milliseconds
dwBuf[5] : [Output] 16-bit digital output data
dwBuf[6] : [Input] 0 → no save to szSend &szReceive
 1 → Save to szSend &szReceive
dwBuf[7] : [Input] Slot number; the I/O module installed in I-8000 main unit.
fBuf : Not used.
szSend : [Input] Command string to be sent to I-8000 series modules.
szReceive : [Output] Result string receiving from I-8000 series modules .

Return Value:

0: The function was successfully processed.

Other: The processing failed.

Refer to Chapter 6.7: “Error Code Definitions” for details of other returned values.

Example:

```
char szSend[80];  
char szReceive[80];  
float fBuf[12];  
DWORD DI;  
DWORD dwBuf[12];  
DWORD m_port=3;  
DWORD m_slot=1;  
DWORD m_address=1;  
DWORD m_timeout=100;  
DWORD m_checksum=0;
```

```

Open_Com(COM3, 9600, Data8Bit, NonParity, OneStopBit);
dwBuf[0] = m_port;
dwBuf[1] = m_address;
dwBuf[2] = 0x8040;
dwBuf[3] = m_checksum;
dwBuf[4] = m_timeout;
dwBuf[5] = 10;           // digital output
dwBuf[6] = 0;
dwBuf[7] = m_slot;
DigitalIn_8K(dwBuf, fBuf, szSend, szReceive);
DI=dwBuf[5];
Close_Com(COM3);

```

Remark:

■ DigitalInCounterRead_8K

Description:

This function is used to output 8-bit data to a digital output module. The 0 to 7 bits of output data are mapped into the 0 to 7 channels of digital module output respectively.

Syntax:

[C]

WORD DigitalInCounterRead_8K(DWORD dwBuf[], float fBuf[], char szSend[], char szReceive[])

Parameter:

- dwBuf: DWORD Input/Output argument talbe
- dwBuf[0] : [Input] COM port number, from 1 to 255
- dwBuf[1] : [Input] Module address, form 0x00 to 0xFF
- dwBuf[2] : [Input] Module ID, 0x8040/51/52/53/54/55/58/63
- dwBuf[3] : [Input] 0= Checksum disable; 1= Checksum enable
- dwBuf[4] : [Input] Timeout setting , normal=100 milliseconds
- dwBuf[5] : [Input] Channel No.

dwBuf[6] : [Input] 0 → no save to szSend &szReceive
 1 → Save to szSend &szReceive
dwBuf[7] : [Input] Slot number; the I/O module installed in I-8000 main unit.
dwBuf[8] : [Output] DigitalIn counter value
fBuf : Not used.
szSend : [Input] Command string to be sent to I-8000 series modules.
szReceive : [Output] Result string receiving from I-8000 series modules .

Return Value:

0: The function was successfully processed.

Other: The processing failed.

Refer to Chapter 6.7: “Error Code Definitions” for details of other returned values.

Example:

```
char szSend[80];
char szReceive[80];
float fBuf[12];
DWORD DI_counter;
DWORD dwBuf[12];
DWORD m_port=3;
DWORD m_slot=1;
DWORD m_address=1;
DWORD m_timeout=100;
DWORD m_checksum=0;
Open_Com(COM3, 9600, Data8Bit, NonParity, OneStopBit);
dwBuf[0] = m_port;
dwBuf[1] = m_address;
dwBuf[2] = 0x8040;
dwBuf[3] = m_checksum;
dwBuf[4] = m_timeout;
dwBuf[5] = 0;
dwBuf[6] = 0;
dwBuf[7] = m_slot;
DigitalInCounterRead_8K(dwBuf, fBuf, szSend, szReceive);
DI_counter=dwBuf[8];
Close_Com(COM3);
```

Remark:

■ **ClearDigitalInCounter_8K**

Description:

This function is used to clear the counter value of the digital input channel No. of I-8000 series modules.

Syntax:

```
[ C ]  
WORD ClearDigitalInCounter_8K(DWORD dwBuf[], float fBuf[],char szSend[],  
char szReceive[])
```

Parameter:

dwBuf: DWORD Input/Output argument talbe
dwBuf[0] : [Input] COM port number, from 1 to 255
dwBuf[1] : [Input] Module address, form 0x00 to 0xFF
dwBuf[2] : [Input] Module ID, 0x8040/51/52/53/54/55/58/63
dwBuf[3] : [Input] 0= Checksum disable; 1= Checksum enable
dwBuf[4] : [Input] Timeout setting , normal=100 milliseconds
dwBuf[5] : [Input] Channel No.
dwBuf[6] : [Input] 0 → no save to szSend &szReceive
 1 → Save to szSend &szReceive
dwBuf[7] : [Input] Slot number; the I/O module installed in I-8000 main unit.
fBuf : Not used.
szSend : [Input] Command string to be sent to I-8000 series modules.
szReceive : [Output] Result string receiving from I-8000 series modules .

Return Value:

0: The function was successfully processed.

Other: The processing failed.

Refer to Chapter 6.7: “Error Code Definitions” for details of other returned values.

Example:

```
char szSend[80];  
char szReceive[80];  
float fBuf[12];  
DWORD dwBuf[12];  
DWORD m_port=3;  
DWORD m_slot=1;  
DWORD m_address=1;  
DWORD m_timeout=100;  
DWORD m_checksum=0;  
Open_Com(COM3, 9600, Data8Bit, NonParity, OneStopBit);
```

```

dwBuf[0] = m_port;
dwBuf[1] = m_address;
dwBuf[2] = 0x8040;
dwBuf[3] = m_checksum;
dwBuf[4] = m_timeout;
dwBuf[5] = 0;
dwBuf[6] = 0;
dwBuf[7] = m_slot;
ClearDigitalInCounter_8K(dwBuf, fBuf, szSend, szReceive);
Close_Com(COM3);

```

Remark:

■ DigitalInLatch_8K

Description:

This function is used to obtain the digital input latch value of the high or low latch mode of I-8000 series modules.

Syntax:

[C]
WORD DigitalInLatch_8K(DWORD dwBuf[], float fBuf[], char szSend[], char szReceive[])

Parameter:

dwBuf:	DWORD Input/Output argument talbe
dwBuf[0] :	[Input] COM port number, from 1 to 255
dwBuf[1] :	[Input] Module address, form 0x00 to 0xFF
dwBuf[2] :	[Input] Module ID, 0x8040/51/52/53/54/55/58/63
dwBuf[3] :	[Input] 0= Checksum disable; 1= Checksum enable
dwBuf[4] :	[Input] Timeout setting , normal=100 milliseconds
dwBuf[5] :	[Input] 0→ select to latch low 1→ select to latch high
dwBuf[6] :	[Input] 0 → no save to szSend &szReceive

1 → Save to szSend &szReceive

dwBuf[7] : [Input] Slot number; the I/O module installed in I-8000 main unit.

dwBuf[8] : [Output] Latched data

fBuf : Not used.

szSend : [Input] Command string to be sent to I-8000 series modules.

szReceive : [Output] Result string receiving from I-8000 series modules .

Return Value:

0: The function was successfully processed.

Other: The processing failed.

Refer to Chapter 6.7: “Error Code Definitions” for details of other returned values.

Example:

```
char szSend[80];
char szReceive[80];
float fBuf[12];
DWORD DI_latch;
DWORD dwBuf[12];
DWORD m_port=3;
DWORD m_slot=1;
DWORD m_address=1;
DWORD m_timeout=100;
DWORD m_checksum=0;
Open_Com(COM3, 9600, Data8Bit, NonParity, OneStopBit);
dwBuf[0] = m_port;
dwBuf[1] = m_address;
dwBuf[2] = 0x8040;
dwBuf[3] = m_checksum;
dwBuf[4] = m_timeout;
dwBuf[5] = 0;
dwBuf[6] = 0;
dwBuf[7] = m_slot;
DigitalInLatch_8K(dwBuf, fBuf, szSend, szReceive);
DI_latch=dwBuf[8];
Close_Com(COM3);
```

Remark:

■ ClearDigitalInLatch_8K

Description:

This function is used to clean the latch status of digital input module when latch function has been enabled.

Syntax:

```
[ C ]  
WORD ClearDigitalInLatch_8K(DWORD dwBuf[], float fBuf[], char szSend[],  
char szReceive[])
```

Parameter:

dwBuf: DWORD Input/Output argument talbe
dwBuf[0] : [Input] COM port number, from 1 to 255
dwBuf[1] : [Input] Module address, form 0x00 to 0xFF
dwBuf[2] : [Input] Module ID, 0x8040/51/52/53/54/55/58/63
dwBuf[3] : [Input] 0= Checksum disable; 1= Checksum enable
dwBuf[4] : [Input] Timeout setting , normal=100 milliseconds
dwBuf[5] : Not used.
dwBuf[6] : [Input] 0 → no save to szSend &szReceive
 1 → Save to szSend &szReceive
dwBuf[7] : [Input] Slot number; the I/O module installed in I-8000 main unit.
fBuf : Not used.
szSend : [Input] Command string to be sent to I-8000 series modules.
szReceive : [Output] Result string receiving from I-8000 series modules .

Return Value:

0: The function was successfully processed.

Other: The processing failed.

Refer to Chapter 6.7: “Error Code Definitions” for details of other returned values.

Example:

```
char szSend[80];  
char szReceive[80];  
float fBuf[12];  
DWORD dwBuf[12];  
DWORD m_port=3;  
DWORD m_slot=1;  
DWORD m_address=1;  
DWORD m_timeout=100;  
DWORD m_checksum=0;  
Open_Com(COM3, 9600, Data8Bit, NonParity, OneStopBit);  
dwBuf[0] = m_port;
```



```
dwBuf[1] = m_address;  
dwBuf[2] = 0x8040;  
dwBuf[3] = m_checksum;  
dwBuf[4] = m_timeout;  
dwBuf[5] = 0;  
dwBuf[6] = 0;  
dwBuf[7] = m_slot;  
ClearDigitalInLatch_8K(dwBuf, fBuf, szSend, szReceive);  
Close_Com(COM3);
```

Remark:

6.2.2.3 I-87000 series modules

■ DigitalOut_87K

Description:

This function is used to set the digital output value of the digital output module for I-87000 series modules.

Syntax:

```
[ C ]  
WORD DigitalOut_87K(DWORD dwBuf[], float fBuf[], char szSend[],char szReceive[])
```

Parameter:

dwBuf: DWORD Input/Output argument talbe
dwBuf[0] : [Input] COM port number, from 1 to 255
dwBuf[1] : [Input] Module address, form 0x00 to 0xFF
dwBuf[2] : [Input] Module ID, 0x87041/54/55/57/58/60/63/64/66/68
dwBuf[3] : [Input] 0= Checksum disable; 1= Checksum enable
dwBuf[4] : [Input] Timeout setting , normal=100 milliseconds
dwBuf[5] : [Input]16-bit digital output data.
dwBuf[6] : [Input] 0 → no save to szSend &szReceive
 1 → Save to szSend &szReceive
fBuf : Not used.
szSend : [Input] Command string to be sent to I-87000 series modules.
szReceive : [Output] Result string receiving from I-87000 series modules .

Return Value:

0: The function was successfully processed.

Other: The processing failed.

Refer to Chapter 6.7: “Error Code Definitions” for details of other returned values.

Example:

```
char szSend[80];  
char szReceive[80];  
float fBuf[12];  
DWORD dwBuf[12];  
DWORD m_port=3;  
DWORD m_slot=1;  
DWORD m_address=1;  
DWORD m_timeout=100;
```

```

DWORD m_checksum=0;
Open_Com(COM3, 9600, Data8Bit, NonParity, OneStopBit);
dwBuf[0] = m_port;
dwBuf[1] = m_address;
dwBuf[2] = 0x87054;
dwBuf[3] = m_checksum;
dwBuf[4] = m_timeout;
dwBuf[5] = 3;
dwBuf[6] = 0;
DigitalOut_87K(dwBuf, fBuf, szSend, szReceive);
Close_Com(COM3);

```

Remark:

■ DigitalOutReadBack_87K

Description:

This function is used to read back the digital output value of the digital output module for I-87000 series modules.

Syntax:

[C]
WORD DigitalOutReadBack_87K(DWORD dwBuf[], float fBuf[], char szSend[], char szReceive[])

Parameter:

dwBuf:	DWORD Input/Output argument talbe
dwBuf[0] :	[Input] COM port number, from 1 to 255
dwBuf[1] :	[Input] Module address, form 0x00 to 0xFF
dwBuf[2] :	[Input] Module ID, 0x87041/54/55/57/58/60/63/64/66/68
dwBuf[3] :	[Input] 0= Checksum disable; 1= Checksum enable
dwBuf[4] :	[Input] Timeout setting , normal=100 milliseconds

dwBuf[5] : [Output]16-bit digital output data.
dwBuf[6] : [Input] 0 → no save to szSend &szReceive
 1 → Save to szSend &szReceive
fBuf : Not used.
szSend : [Input] Command string to be sent to I-87000 series modules.
szReceive : [Output] Result string receiving from I-87000 series modules .

Return Value:

0: The function was successfully processed.

Other: The processing failed.

Refer to Chapter 6.7: “Error Code Definitions” for details of other returned values.

Example:

```
char szSend[80];
char szReceive[80];
float fBuf[12];
DWORD DO;
DWORD dwBuf[12];
DWORD m_port=3;
DWORD m_slot=1;
DWORD m_address=1;
DWORD m_timeout=100;
DWORD m_checksum=0;
Open_Com(COM3, 9600, Data8Bit, NonParity, OneStopBit);
dwBuf[0] = m_port;
dwBuf[1] = m_address;
dwBuf[2] = 0x87054;
dwBuf[3] = m_checksum;
dwBuf[4] = m_timeout;
dwBuf[6] = 0;
DigitalOutReadBack_87K (dwBuf, fBuf, szSend, szReceive);
DO=dwBuf[5] ;
Close_Com(COM3);
```

Remark:

■ DigitalBitOut_87K

Description:

This function is used to set the digital output value of the specific digital output channel No. of the digital output module for I-87000 series modules. The output value is only for “0” or “1”.

Syntax:

```
[ C ]  
WORD DigitalBitOut_87K(DWORD dwBuf[], float fBuf[], char szSend[],  
char szReceive[])
```

Parameter:

dwBuf: DWORD Input/Output argument talbe
dwBuf[0] : [Input] COM port number, from 1 to 255
dwBuf[1] : [Input] Module address, form 0x00 to 0xFF
dwBuf[2] : [Input] Module ID, 0x87041/54/55/57/58/60/63/64/66/68
dwBuf[3] : [Input] 0= Checksum disable; 1= Checksum enable
dwBuf[4] : [Input] Timeout setting , normal=100 milliseconds
dwBuf[5] : [Input] 1-bit digital output data.
dwBuf[6] : [Input] 0 → no save to szSend &szReceive
 1 → Save to szSend &szReceive
dwBuf[7] : [Input] The digital output channel No.
dwBuf[8] : [Input] Data to output(0 or 1)
fBuf : Not used.
szSend : [Input] Command string to be sent to I-87000 series modules.
szReceive : [Output] Result string receiving from I-87000 series modules .

Return Value:

0: The function was successfully processed.

Other: The processing failed.

Refer to Chapter 6.7: “Error Code Definitions” for details of other returned values.

Example:

```
char szSend[80];  
char szReceive[80];  
float fBuf[12];  
DWORD dwBuf[12];  
DWORD m_port=3;
```

```

DWORD m_slot=1;
DWORD m_address=1;
DWORD m_timeout=100;
DWORD m_checksum=0;
Open_Com(COM3, 9600, Data8Bit, NonParity, OneStopBit);
dwBuf[0] = m_port;
dwBuf[1] = m_address;
dwBuf[2] = 0x87054;
dwBuf[3] = m_checksum;
dwBuf[4] = m_timeout;
dwBuf[5] = 1;
dwBuf[6] = 0;
dwBuf[7] = 1;
dwBuf[8] = 1;
DigitalBitOut_87K(dwBuf, fBuf, szSend, szReceive);
Close_Com(COM3);

```

Remark:

■ **DigitalIn_87K**

Description:

This function is used to obtain the digital input value from I-87000 series modules.

Syntax:

[C]

WORD DigitalIn_87K(DWORD dwBuf[], float fBuf[],char szSend[], char szReceive[])

Parameter:

- dwBuf: DWORD Input/Output argument talbe
- dwBuf[0] : [Input] COM port number, from 1 to 255
- dwBuf[1] : [Input] Module address, form 0x00 to 0xFF
- dwBuf[2] : [Input] Module ID, 0x87040/51/52/53/54/55/58/63
- dwBuf[3] : [Input] 0= Checksum disable; 1= Checksum enable
- dwBuf[4] : [Input] Timeout setting , normal=100 milliseconds
- dwBuf[5] : [Output]16-bit digitalinput data.

dwBuf[6] : [Input] 0 → no save to szSend &szReceive
 1 → Save to szSend &szReceive
fBuf : Not used.
szSend : [Input] Command string to be sent to I-87000 series modules.
szReceive : [Output] Result string receiving from I-87000 series modules .

Return Value:

0: The function was successfully processed.

Other: The processing failed.

Refer to Chapter 6.7: “Error Code Definitions” for details of other returned values.

Example:

```
char szSend[80];
char szReceive[80];
float fBuf[12];
DWORD DI;
DWORD dwBuf[12];
DWORD m_port=3;
DWORD m_slot=1;
DWORD m_address=1;
DWORD m_timeout=100;
DWORD m_checksum=0;
Open_Com(COM3, 9600, Data8Bit, NonParity, OneStopBit);
dwBuf[0] = m_port;
dwBuf[1] = m_address;
dwBuf[2] = 0x87054;
dwBuf[3] = m_checksum;
dwBuf[4] = m_timeout;
dwBuf[6] = 0;
DigitalIn_87K(dwBuf, fBuf, szSend, szReceive);
DI=dwBuf[5];
Close_Com(COM3);
```

Remark:

■ DigitalInLatch_87K

Description:

This function is used to obtain the digital input latch value of the high or low latch mode of I-87000 series modules.

Syntax:

```
[ C ]  
WORD DigitalInLatch_87K(DWORD dwBuf[], float fBuf[], char szSend[],  
                        char szReceive[])
```

Parameter:

dwBuf: DWORD Input/Output argument talbe
dwBuf[0] : [Input] COM port number, from 1 to 255
dwBuf[1] : [Input] Module address, form 0x00 to 0xFF
dwBuf[2] : [Input] Module ID, 0x87040/51/52/53/54/55/58/63
dwBuf[3] : [Input] 0= Checksum disable; 1= Checksum enable
dwBuf[4] : [Input] Timeout setting , normal=100 milliseconds
dwBuf[5] : [Input] 0:low latch mode, 1:high latch mode
dwBuf[6] : [Input] 0 → no save to szSend &szReceive
 1 → Save to szSend &szReceive
dwBuf[7] : [Output] Latch value
fBuf : Not used.
szSend : [Input] Command string to be sent to I-87000 series modules.
szReceive : [Output] Result string receiving from I-87000 series modules .

Return Value:

0: The function was successfully processed.

Other: The processing failed.

Refer to Chapter 6.7: “Error Code Definitions” for details of other returned values.

Example:

```
char szSend[80];  
char szReceive[80];  
float fBuf[12];  
DWORD DI_latch;  
DWORD dwBuf[12];  
DWORD m_port=3;  
DWORD m_slot=1;
```



```

DWORD m_address=1;
DWORD m_timeout=100;
DWORD m_checksum=0;
Open_Com(COM3, 9600, Data8Bit, NonParity, OneStopBit);
dwBuf[0] = m_port;
dwBuf[1] = m_address;
dwBuf[2] = 0x87051;
dwBuf[3] = m_checksum;
dwBuf[4] = m_timeout;
dwBuf[5] = 1;
dwBuf[6] = 0;
DigitalInLatch_87K(dwBuf, fBuf, szSend, szReceive);
DI_latch=dwBuf[7];
Close_Com(COM3);

```

Remark:

■ ClearDigitalInLatch_87K

Description:

This function is used to output 8-bit data to a digital output module. The 0 to 7 bits of output data are mapped into the 0 to 7 channels of digital module output respectively.

Syntax:

[C]
WORD ClearDigitalInLatch_87K(DWORD dwBuf[], float fBuf[], char szSend[], char szReceive[])

Parameter:

dwBuf:	DWORD Input/Output argument talbe
dwBuf[0] :	[Input] COM port number, from 1 to 255
dwBuf[1] :	[Input] Module address, form 0x00 to 0xFF
dwBuf[2] :	[Input] Module ID, 0x87040/51/52/53/54/55/58/63
dwBuf[3] :	[Input] 0= Checksum disable; 1= Checksum enable

dwBuf[4] : [Input] Timeout setting , normal=100 milliseconds
dwBuf[5] : Not used
dwBuf[6] : [Input] 0 → no save to szSend &szReceive
 1 → Save to szSend &szReceive
fBuf : Not used.
szSend : [Input] Command string to be sent to I-87000 series modules.
szReceive : [Output] Result string receiving from I-87000 series modules .

Return Value:

0: The function was successfully processed.

Other: The processing failed.

Refer to Chapter 6.7: “Error Code Definitions” for details of other returned values.

Example:

```
char szSend[80];  
char szReceive[80];  
float fBuf[12];  
DWORD dwBuf[12];  
DWORD m_port=3;  
DWORD m_slot=1;  
DWORD m_address=1;  
DWORD m_timeout=100;  
DWORD m_checksum=0;  
Open_Com(COM3, 9600, Data8Bit, NonParity, OneStopBit);  
dwBuf[0] = m_port;  
dwBuf[1] = m_address;  
dwBuf[2] = 0x87051;  
dwBuf[3] = m_checksum;  
dwBuf[4] = m_timeout;  
dwBuf[6] = 0;  
ClearDigitalInLatch_87K(dwBuf, fBuf, szSend, szReceive);  
Close_Com(COM3);
```

Remark:

■ DigitalInCounterRead_87K

Description:

This function is used to obtain the counter value of the digital input channel No. of I-87000 series modules.

Syntax:

```
[ C ]  
WORD DigitalInCounterRead_87K(DWORD dwBuf[], float fBuf[], char szSend[],  
char szReceive[])
```

Parameter:

dwBuf: DWORD Input/Output argument talbe
dwBuf[0] : [Input] COM port number, from 1 to 255
dwBuf[1] : [Input] Module address, form 0x00 to 0xFF
dwBuf[2] : [Input] Module ID, 0x87040/51/52/53/54/55/58/63
dwBuf[3] : [Input] 0= Checksum disable; 1= Checksum enable
dwBuf[4] : [Input] Timeout setting , normal=100 milliseconds
dwBuf[5] : [Input] The digital input channel No.
dwBuf[6] : [Input] 0 → no save to szSend &szReceive
 1 → Save to szSend &szReceive
dwBuf[7] : [Output] Counter value of the digital input channel No.
fBuf : Not used.
szSend : [Input] Command string to be sent to I-87000 series modules.
szReceive : [Output] Result string receiving from I-87000 series modules .

Return Value:

0: The function was successfully processed.

Other: The processing failed.

Refer to Chapter 6.7: "Error Code Definitions" for details of other returned values.

Example:

```
char szSend[80];  
char szReceive[80];  
float fBuf[12];  
DWORD DI_counter;  
DWORD dwBuf[12];  
DWORD m_port=3;  
DWORD m_slot=1;
```

```

DWORD m_address=1;
DWORD m_timeout=100;
DWORD m_checksum=0;
Open_Com(COM3, 9600, Data8Bit, NonParity, OneStopBit);
dwBuf[0] = m_port;
dwBuf[1] = m_address;
dwBuf[2] = 0x87051;
dwBuf[3] = m_checksum;
dwBuf[4] = m_timeout;
dwBuf[5] = 1;
dwBuf[6] = 0;
DigitalInCounterRead_87K (dwBuf, fBuf, szSend, szReceive);
DI_counter=dwBuf[7];
Close_Com(COM3);

```

Remark:

■ ClearDigitalInCounter_87K

Description:

This function is used to clear the counter value of the digital input channel No. of I-87000 series modules.

Syntax:

[C]
WORD ClearDigitalInCounter_87K(DWORD dwBuf[], float fBuf[], char szSend[], char szReceive[])

Parameter:

dwBuf:	DWORD Input/Output argument talbe
dwBuf[0] :	[Input] COM port number, from 1 to 255
dwBuf[1] :	[Input] Module address, form 0x00 to 0xFF
dwBuf[2] :	[Input] Module ID, 0x87040/51/52/53/54/55/58/63
dwBuf[3] :	[Input] 0= Checksum disable; 1= Checksum enable

dwBuf[4] : [Input] Timeout setting , normal=100 milliseconds
dwBuf[5] : [Input] The digital input channel No.
dwBuf[6] : [Input] 0 → no save to szSend &szReceive
 1 → Save to szSend &szReceive
fBuf : Not used.
szSend : [Input] Command string to be sent to I-87000 series modules.
szReceive : [Output] Result string receiving from I-87000 series modules .

Return Value:

0: The function was successfully processed.

Other: The processing failed.

Refer to Chapter 6.7: “Error Code Definitions” for details of other returned values.

Example:

```
char szSend[80];  
char szReceive[80];  
float fBuf[12];  
DWORD dwBuf[12];  
DWORD m_port=3;  
DWORD m_slot=1;  
DWORD m_address=1;  
DWORD m_timeout=100;  
DWORD m_checksum=0;  
Open_Com(COM3, 9600, Data8Bit, NonParity, OneStopBit);  
dwBuf[0] = m_port;  
dwBuf[1] = m_address;  
dwBuf[2] = 0x87051;  
dwBuf[3] = m_checksum;  
dwBuf[4] = m_timeout;  
dwBuf[5] = 1;  
dwBuf[6] = 0;  
ClearDigitalInCounter_87K(dwBuf, fBuf, szSend, szReceive);  
Close_Com(COM3);
```

Remark:

6.3 Analog Input Functions

6.3.1 For I-8000 modules via parallel port

■ I8017_GetFirmwareVersion

Description:

This function is used to get the lattice version of I-8017HW at specific slot.

Syntax:

```
[ C ]  
int I8017_GetFirmwareVersion(int slot)
```

Parameter:

slot : [Input] Specifies the slot where the I/O module is inserted. (Range: 1 to 8)

Return Value:

> 0 : Version no.

<=0 :error

Example:

```
int slot=1,ver;  
ver=I8017_GetFirmwareVersion (slot);  
// The I-8017HW card is inserted in slot 1 of LP-8x21 and initializes the module.
```

Remark:

This function can be applied on module: I-8017HW.

■ I8017_Init

Description:

This function is used to initialize the I-8017HW modules (Analog input module) into the specified slot. Users must execute this function before trying to use other functions within the I-8017HW modules.

Syntax:

```
int I8017_Init(int slot) [ C ]
```

Parameter:

slot : [Input] Specifies the slot where the I/O module is inserted. (Range: 1 to 8)

Return Value:

The version of library

Example:

```
int slot=1,ver;  
ver=I8017_Init(slot);  
// The I-8017HW is inserted in slot 1 of LP-8x21 and initializes the module.
```

Remark:

This function can be applied on module: I-8017HW.

■ I8017_SetLed

Description:

Turns the I-8017HW modules LED's on/off. They can be used to act as an alarm.

Syntax:

```
[ C ]  
void I8017_SetLed(int slot, unsigned int led)
```

Parameter:

slot : [Input] Specifies the slot where the I/O module is inserted. (Range: 1 to 8)
led : [Input] range from 0 to 0xffff

Return Value:

None

Example:

```
int slot=1;  
unsigned int led=0x0001;  
I8017_SetLed (slot, led);  
// There will be a LED light on channel 0 of the I-8017HW card which is inserted in slot 1  
on the LP-8x21.
```

Remark:

This function can be applied on module: I-8017HW.

■ I8017_GetSingleEndJumper

Description:

This function is used to get the mode of input channels, single-end or differential.

Syntax:

```
[ C ]  
void I8017_GetSingleEndJumper(int slot)
```

Parameter:

slot : [Input] Specifies the slot where the I/O module is inserted. (Range: 1 to 8)

Return Value:

1: Single-End mode

0: Differential mode.

Example:

```
int slot=1;  
printf("mode=%d", I8017_GetSingleEndJumper(slot));
```

Remark:

This function can be applied on module: I-8017HW.

■ I8017_SetChannelGainMode

Description:

This function is used to configure the range and mode of the analog input channel for the I-8017HW modules in the specified slot before using the ADC (analog to digital converter).

Syntax:

```
[ C ]  
void I8017_SetChannelGainMode (int slot, int ch, int gain, int mode)
```

Parameter:

- slot : [Input] Specifies the slot where the I/O module is inserted. (Range: 1 to 8)
- ch : [Input] I-8017H : Range 0 to 7.
I-8017HS/I-8017HW : Single-end mode → Range 0 to 15
Differential mode → Range 0 to 7
- gain : [Input] input range:
0: +/- 10.0V,
1: +/- 5.0V,
2: +/- 2.5V,
3: +/- 1.25V,
4: +/- 20mA.
- mode : [Input] **0: normal mode** (polling)

Return Value:

None

Example:

```
int slot=1,ch=0,gain=0;  
I8017_SetChannelGainMode (slot, ch, gain,0);  
// The I-8017HW card is inserted in slot 1 of LP-8x21, and the range of the data // value  
from channel 0 for I-8017H will be -10 to +10 V.
```

Remark:

This function can be applied on module: I-8017WH.

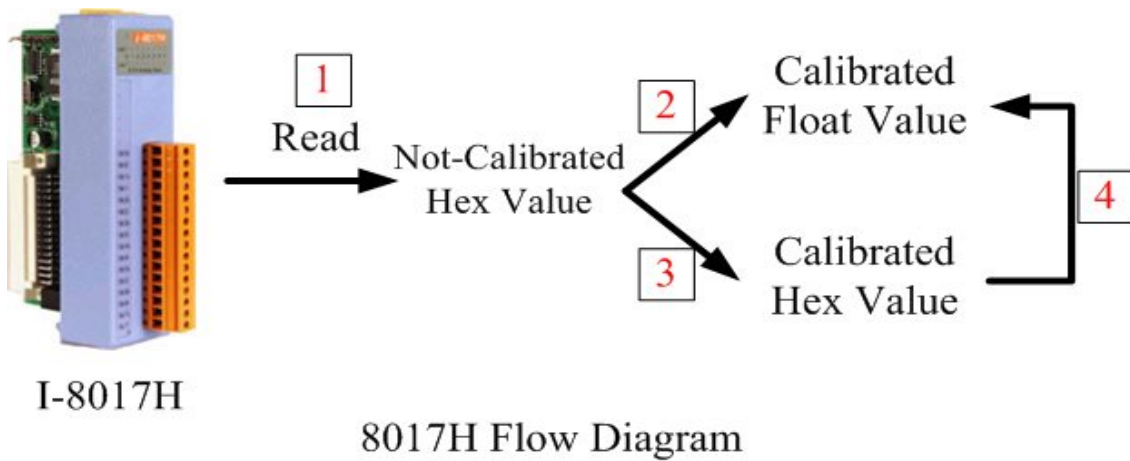

Fig.6-2

Function of [1]

■ I8017_GetCurAdChannel_Hex

Description:

Obtains the non-calibrated analog input value in the Hex format from the analog input I-8017HW modules. Please refer to Fig. 6-2

Syntax:

```
[ C ]
```

```
int I8017_GetCurAdChannel_Hex (int slot)
```

Parameter:

slot : [Input] Specifies the slot where the I/O module is inserted. (Range: 1 to 8)

Return Value:

The analog input value in Hex format.

Example:

```
int slot=1,ch=0,gain=4;
int data;
I8017_SetChannelGainMode (slot, ch, gain,0);
data= I8017_GetCurAdChannel_Hex (slot);
// The I-8017HW is inserted in slot 1 of LP-8x21 and the range of the data
// value from channel 0 in I-8017H is +/- 20mA
```

■ I8017_AD_POLLING

Description:

This function is used to get the analog input non-calibrated hex values of the specified channel from an analog input module and can convert it to the value according to the slot configuration, the gain and the data number.

Syntax:

```
[ C ]  
int I8017_AD_POLLING(int slot, int ch, int gain, unsigned int datacount, int *DataPtr)
```

Parameter:

slot : [Input] Specifies the slot where the I/O module is inserted. (Range: 1 to 8)

ch : [Input] I-8017H : Range 0 to 7.
I-8017HS/I-8017HW : Single-end mode→ Range 0 to 15
Differential mode→ Range 0 to 7

gain : [Input] Input range:
0: +/- 10.0V,
1: +/- 5.0V,
2: +/- 2.5V,
3: +/- 1.25V,
4: +/- 20mA.

datacount : [Input] Range from 1 to 8192, total ADCs number

*DataPtr : [Output] The starting address of data array[] and the array size must be equal to or bigger than the datacount.

Return Value:

0 : indicates success.
Not 0 : indicates failure.

Examples:

```
int slot=1, ch=0, gain=0, data[10];  
unsigned int datacount = 10;  
I8017_AD_POLLING(slot, ch, gain, datacount, data);  
// You gain ten not-calibrated hex values via channel 0 in the I-8017H module.
```

Remark:

You can use ARRAY_HEX_TO_FLOAT_Cal() or HEX_TO_FLOAT_Cal() to calibrate the data and convert to float value.

Function of [2]

■ I8017_HEX_TO_FLOAT_Cal

Description:

This function is used to convert the data from not-calibrated hex to calibrated float values based on the configuration of the slot, gain. (Voltage or current). Please refer to the Fig. 6-2.

Syntax:

[C]
<code>float I8017_HEX_TO_FLOAT_Cal(int HexValue, int slot, int gain)</code>

Parameter:

HexValue : [Input] specified not-calibrated HexValue before converting

slot : [Input] specified slot of the LP-8x21 system (Range: 1 to 8)

gain : [Input] Input range:

0: +/- 10.0V,

1: +/- 5.0V,

2: +/- 2.5V,

3: +/- 1.25V,

4: +/- 20mA.

Return Value:

The Calibrated Float Value.

Examples:

```
int slot=1, ch=0, gain=0, hdata;
```

```
float fdata;
```

```
I8017_SetChannelGainMode (slot, ch, gain,0);
```

```
hdata = I8017_I8017_GetCurAdChannel_Hex (slot);
```

```
fdata = I8017_HEX_TO_FLOAT_Cal(hdata, slot, gain);
```

```
// You can convert not-calibrated Hex Value to calibrated Float Value
```

Remark:

This function can be applied on module: I-8017HW .

■ I8017_ARRAY_HEX_TO_FLOAT_Cal

Description:

This function is used to convert the data from non-calibrated hex values to calibrated float values in the array mode based on the slot's configuration. (Voltage or current). Please refer to Fig. 6-2.

Syntax:

```
[ C ]  
void I8017_ARRAY_HEX_TO_FLOAT_cal(int *HexValue, float *FloatValue, int slot,  
int gain,int len)
```

Parameter:

*HexValue : [Input] data array in not-calibrated Hex type before converting
*FloatValue : [Output] Converted data array in calibrated float type
slot : [Input] Specifies the slot where the I/O module is inserted. (Range: 1 to 8)
gain : [Input] Input range:
0: +/- 10.0V,
1: +/- 5.0V,
2: +/- 2.5V,
3: +/- 1.25V,
4: +/- 20mA.
len : [input] ADC data length

Return Value:

None

Examples:

```
int slot=1, ch=0, gain=0, datacount=10, hdata[10];  
float fdata[10];  
I8017_SetChannelGainMode (slot, ch, gain,0);  
I8017_AD_POLLING(slot, ch, gain, datacount, data);  
I8017_ARRAY_HEX_TO_FLOAT_Cal(data, fdata, slot, gain, len);  
// You can convert ten not-calibrated Hex values to ten calibrated Float values
```

Remark:

This function can be applied on module: I-8017HW.

Function of [3]

■ I8017_Hex_Cal

Description:

This function is used to convert the data from non-calibrated hex values to calibrated hex values. (Voltage or current). Please refer to Fig. 6-2.

Syntax:

[C]
<code>int I8017_Hex_Cal(int data)</code>

Parameter:

data : [Input] specified not-calibrated hex value

Return Value:

The Calibrated Hex Value.

Examples:

```
int slot=1, ch=0, gain=0, hdata;  
int hdata_cal;  
I8017_SetChannelGainMode (slot, ch, gain,0);  
hdata = I8017_GetCurAdChannel_Hex (slot);  
hdata_cal = I8017_Hex_Cal (hdata);  
// You can convert not-calibrated Hex Value to calibrated Hex Value
```

Remark:

This function can be applied on module: I-8017HW.

■ I8017_Hex_Cal_Slot_Gain

Description:

This function is used to convert the data from non-calibrated hex values to calibrated hex values based on the configuration of the slot, gain(Voltage or current). Please refer to the Fig. 6-2.

Syntax:

```
[ C ]  
int I8017_Hex_Cal_Slot_Gain(int slot, int gain, int data)
```

Parameter:

- slot : [Input] Specifies the slot where the I/O module is inserted. (Range: 1 to 8)
- gain : [Input] Input range:
 - 0: +/- 10.0V,
 - 1: +/- 5.0V,
 - 2: +/- 2.5V,
 - 3: +/- 1.25V,
 - 4: +/- 20mA.
- data : [Input] specified not-calibrated hex value.

Return Value:

The Calibrated Hex Value.

Examples:

```
int slot=1, ch=0, gain=0, hdata;  
int hdata_cal;  
I8017_SetChannelGainMode (slot, ch, gain,0);  
hdata = I8017_GetCurAdChannel_Hex (slot);  
hdata_cal = I8017_Hex_Cal_Slot_Gain (slot, gain, hdata);  
// You can convert not-calibrated Hex Value to calibrated Hex Value according to the  
// gain of slot you choose.
```

Remark:

This function can be applied on module: I-8017HW.

Function of [4]

■ I8017_CalHEX_TO_FLOAT

Description:

This function is used to convert the data from calibrated hex values to calibrated float values based on the configuration of the gain. (Voltage or current). Please refer to Fig. 6-2.

Syntax:

```
[ C ]  
float I8017_CalHex_TO_FLOAT(int HexValue,int gain)
```

Parameter:

HexValue : [Input] specified not-calibrated HexValue before converting

gain : [Input] Input range:

0: +/- 10.0V,

1: +/- 5.0V,

2: +/- 2.5V,

3: +/- 1.25V,

4: +/- 20mA.

Return Value:

The Calibrated Float Value.

Examples:

```
int slot=1, ch=0, gain=0, hdata, hdata_cal;  
float fdata;  
I8017_SetChannelGainMode (slot, ch, gain,0);  
hdata = I8017_GetCurAdChannel_Hex (slot);  
hdata_cal = I8017_HEX_Cal(hdata);  
fdata = I8017_CalHex_TO_FLOAT(hdata_cal, gain);  
// You can convert calibrated Hex Value to calibrated Float Value
```

Remark:

This function can be applied on module: I-8017HW.

■ I8017_ARRAY_CalHEX_TO_FLOAT

Description:

This function is used to convert the data from calibrated hex values to calibrated float values in the array mode based on the configuration of the gain. (Voltage or current). Please refer to the Fig. 6-2.

Syntax:

```
[ C ]  
void I8017_ARRAY_CalHex_TO_FLOAT(int *HexValue, float *FloatValue, int gain, int len)
```

Parameter:

*HexValue : [Input] data array in calibrated Hex format

*FloatValue : [Output] Converted data array in calibrated float format

gain : [Input] Input range:
0: +/- 10.0V,
1: +/- 5.0V,
2: +/- 2.5V,
3: +/- 1.25V,
4: +/- 20mA.

len : [input] ADC data length

Return Value:

The Calibrated Float Value.

Examples:

```
int slot=1, ch=0, gain=0, hdata_cal[10];  
float fdata[10];  
fdata = I8017_ARRAY_CalHex_TO_FLOAT (hdata_cal, fdata, gain, len);  
// You can convert ten calibrated Hex Values to ten calibrated Float Values.
```

Remark:

This function can be applied on module: I-8017HW.

Function of [1] + [3]

■ I8017_GetCurAdChannel_Hex_Cal

Description:

Obtain the calibrated analog input values in the Hex format directly from the analog input modules, I-8017H/I-8017HS/I-8017HW. This function is a combination of the “I8017_GetCurAdChannel_Hex” and the “I8017_Hex_Cal” function. Please refer to Fig. 6-2.

Syntax:

[C]
<code>int I8017_GetCurAdChannel_Hex_Cal(int slot)</code>

Parameter:

slot : [Input] Specifies the slot where the I/O module is inserted. (Range: 1 to 8)

Return Value:

The analog input value in Calibrated Hex format.

Example:

```
int slot=1,ch=0,gain=0, data;  
I8017_SetChannelGainMode (slot, ch, gain,0);  
data = I8017_GetCurAdChannel_Hex_Cal (slot);  
// The I-8017H card is inserted in slot 1 of LP-8x21 and the range of the  
// data value from channel 0 in I-8017H is 0x0000 to 0x3fff.
```

Remark:

This function can be applied on module: I-8017HW.

■ I8017_AD_POLLING_Cal

Description:

This function is used to get the analog input calibrated hex values in the array mode from an analog input module and can convert according to the slot configuration value, the gain and the data number.

Syntax:

```
                                [ C ]  
int I8017_AD_POLLING_Cal(int slot, int ch, int gain, unsigned int datacount,  
                        int *DataPtr)
```

Parameter:

slot : [Input] Specifies the slot where the I/O module is inserted. (Range: 1 to 8)

ch : [Input] I-8017HW : Range 0 to 7.
I-8017HS/I-8017HW : Single-end mode → Range 0 to 15
Differential mode → Range 0 to 7

gain : [Input] Input range:
0: +/- 10.0V,
1: +/- 5.0V,
2: +/- 2.5V,
3: +/- 1.25V,
4: +/- 20mA.

datacount : [Input] Range from 1 to 8192, total ADCs number

*DataPtr : [Output] The starting address of data array[] and the array size must be equal to or bigger than the datacount.

Return Value:

0: The function was successfully processed.
Other: The processing failed.
Refer to Chapter 6.7: "Error Code Definitions" for details of other returned values.

Example:

```
int slot=1, ch=0, gain=0, data[10];  
unsigned int datacount = 10;  
I8017_AD_POLLING_Cal(slot, ch, gain, datacount, data);  
// You gain ten calibrated hex values via channel 0 in the I-8017HW module.
```

Function of [1]+[2]

■ I8017_GetCurAdChannel_Float_Cal

Description:

Obtains the calibrated analog input value in the Float format directly from the analog input modules. This function is a combination of the “I8017_GetCurAdChannel_Hex” and the “Hex_TO_FLOAT_Cal” function. Please refer to Fig. 6-2.

Syntax:

```
[ C ]  
int I8017_GetCurAdChannel_Float_Cal(int slot)
```

Parameter:

slot : [Input] Specifies the slot where the I/O module is inserted. (Range: 1 to 8)

Return Value:

The analog input value in Calibrated Float format.

Example:

```
int slot=1,ch=0,gain=0;  
float data;  
I8017_SetChannelGainMode (slot, ch, gain,0);  
data = I8017_GetCurAdChannel_Float_Cal (slot);  
// The I-8017HW is inserted in slot 1 of LP-8x21 and the range of the  
// data value from channel 0 in I-8017H is -10V to +10V.
```

Remark:

This function can be applied on module: I-8017HW.

6.3.2 For I-7000/I-8000/I-87000 modules via serial port

6.3.2.1 I-7000 series modules

■ AnalogIn

Description:

This function is used to obtain input value form I-7000 series modules.

Syntax:

[C]
WORD AnalogIn (WORD wBuf[], float fBuf[],char szSend[],char szReceive[])

Parameter:

wBuf: WORD Input/Output argument talbe
wBuf[0] : [Input] COM port number, from 1 to 255
wBuf[1] : [Input] Module address, form 0x00 to 0xFF
wBuf[2] : [Input] Module ID, 0x7005/11/12/13/14/15/16/17/18/19/33
wBuf[3] : [Input] 0= Checksum disable; 1= Checksum enable
wBuf[4] : [Input] Timeout setting , normal=100 milliseconds
wBuf[5] : [Input] Channel number for multi-channel
wBuf[6] : [Input] 0 → no save to szSend & szReceive
 1 → Save to szSend & szReceive
fBuf : Float Input/Ouput argument table.
fBuf[0] : [Output] Analog input value return
szSend : [Input] Command string to be sent to I-7000 series modules.
szReceive : [Output] Result string receiving from I-7000 series modules .

Note : “wBuf[6]” is the debug setting. If this parameter is set as “1”, user can get whole command string and result string from szSend[] and szReceive[] respectively.

Return Value:

0: The function was successfully processed.

Other: The processing failed.

Refer to Chapter 6.7: “Error Code Definitions” for details of other returned values.

Example:

```
float AI;  
float fBuf[12];  
char szSend[80];  
char szReceive[80];  
WORD wBuf[12];
```

```
WORD m_port=3;
WORD m_address=1;
WORD m_timeout=100;
WORD m_checksum=0;
Open_Com(COM3, 9600, Data8Bit, NonParity, OneStopBit);
wBuf[0] = m_port;
wBuf[1] = m_address;
wBuf[2] = 0x7016;
wBuf[3] = m_checksum;
wBuf[4] = m_timeout;
wBuf[5] = 0;
wBuf[6] = 1;
AnalogIn (wBuf, fBuf, szSend, szReceive); // szSend="#02" , szReceive=">+001.9"
AI = fBuf[0]; // AI = 1.9
Close_Com(COM3);
```

Remark:

■ AnalogInHex

Description:

This function is used to obtain the analog input value in “Hexadecimal” form I-7000 series modules.

Syntax:

[C]
WORD AnalogInHex (WORD wBuf[], float fBuf[],char szSend[],char szReceive[])

Parameter:

- wBuf: WORD Input/Output argument talbe
 - wBuf[0] : [Input] COM port number, from 1 to 255
 - wBuf[1] : [Input] Module address, form 0x00 to 0xFF
 - wBuf[2] : [Input] Module ID, 0x7005/11/12/13/14/15/16/17/18/19/33
 - wBuf[3] : [Input] 0= Checksum disable; 1= Checksum enable
 - wBuf[4] : [Input] Timeout setting , normal=100 milliseconds
 - wBuf[5] : [Input] Channel number for multi-channel
 - wBuf[6] : [Input] 0 → no save to szSend & szReceive
1 → Save to szSend & szReceive
 - wBuf[7] : [Ouput] The analog input value in “Hexadecimal “ format
 - fBuf : Not used.
 - szSend : [Input] Command string to be sent to I-7000 series modules.
 - szReceive : [Output] Result string receiving from I-7000 series modules .
- Note : Users have to use DCON utility to set up the analog input configuration of the module in hex format.

Return Value:

- 0: The function was successfully processed.
 - Other: The processing failed.
- Refer to Chapter 6.7: “Error Code Definitions” for details of other returned values.

Example:

```
float AI;  
float fBuf[12];  
char szSend[80];  
char szReceive[80];  
WORD wBuf[12];  
WORD m_port=3;
```



```

WORD m_address=1;
WORD m_timeout=100;
WORD m_checksum=0;
Open_Com(COM3, 9600, Data8Bit, NonParity, OneStopBit);
wBuf[0] = m_port;
wBuf[1] = m_address;
wBuf[2] = 0x7012;
wBuf[3] = m_checksum;
wBuf[4] = m_timeout;
wBuf[5] = 0;
wBuf[6] = 1;
AnalogInHex (wBuf, fBuf, szSend, szReceive);
AI = wBuf[7];                // Hex format
Close_Com(COM3);

```

Remark:

■ AnalogInFsr

Description:

This function is used to obtain the analog input value in “FSR” format form I-7000 series modules. The “FSR” means “Percent” format.

Syntax:

[C]
WORD AnalogInFsr (WORD wBuf[], float fBuf[],char szSend[],char szReceive[])

Parameter:

wBuf: WORD Input/Output argument talbe

wBuf[0] : [Input] COM port number, from 1 to 255

wBuf[1] : [Input] Module address, form 0x00 to 0xFF

wBuf[2] : [Input] Module ID, 0x7005/11/12/13/14/15/16/17/18/19/33

wBuf[3] : [Input] 0= Checksum disable; 1= Checksum enable

wBuf[4] : [Input] Timeout setting , normal=100 milliseconds

wBuf[5] : [Input] Channel number for multi-channel

wBuf[6] : [Input] 0 → no save to szSend & szReceive
1 → Save to szSend &szReceive

fBuf : Float Input/Output argument table.

fBuf[0] : [Output] Analog input value return

szSend : [Input] Command string to be sent to I-7000 series modules.

szReceive : [Output] Result string receiving from I-7000 series modules .

Note : Users have to use DCON utility to set up the analog input configuration of the module in hex format.

Return Value:

0: The function was successfully processed.

Other: The processing failed.

Refer to Chapter 6.7: “Error Code Definitions” for details of other returned values.

Examples:

```
float AI;
float fBuf[12];
char szSend[80];
char szReceive[80];
WORD wBuf[12];
WORD m_port=3;
WORD m_address=1;
WORD m_timeout=100;
WORD m_checksum=0;
Open_Com(COM3, 9600, Data8Bit, NonParity, OneStopBit);
wBuf[0] = m_port;
wBuf[1] = m_address;
wBuf[2] = 0x7012;
wBuf[3] = m_checksum;
wBuf[4] = m_timeout;
wBuf[5] = 0;
wBuf[6] = 1;
AnalogInFsr(wBuf, fBuf, szSend, szReceive);
AI = wBuf[7];
Close_Com(COM3);
```

Remark:

■ AnalogInAll

Description:

This function is used to obtain the analog input value of all channels form I-7000 series modules.

Syntax:

```
[ C ]  
WORD AnalogInAll (WORD wBuf[], float fBuf[],char szSend[],char szReceive[])
```

Parameter:

wBuf: WORD Input/Output argument talbe
wBuf[0] : [Input] COM port number, from 1 to 255
wBuf[1] : [Input] Module address, form 0x00 to 0xFF
wBuf[2] : [Input] Module ID, 0x7005/15/16/17/18/19/33
wBuf[3] : [Input] 0= Checksum disable; 1= Checksum enable
wBuf[4] : [Input] Timeout setting , normal=100 milliseconds
wBuf[6] : [Input] 0 → no save to szSend & szReceive
 1 → Save to szSend & szReceive
fBuf : Float Input/Output argument table.
fBuf[0] : [Output] Analog input value return of channel_0
fBuf[1] : [Output] Analog input value return of channel_1
fBuf[2] : [Output] Analog input value return of channel_2
fBuf[3] : [Output] Analog input value return of channel_3
fBuf[4] : [Output] Analog input value return of channel_4
fBuf[5] : [Output] Analog input value return of channel_5
fBuf[6] : [Output] Analog input value return of channel_6
fBuf[7] : [Output] Analog input value return of channel_7
szSend : [Input] Command string to be sent to I-7000 series modules.
szReceive : [Output] Result string receiving from I-7000 series modules .

Note : Users have to use DCON utility to set up the analog input configuration of the module in hex format.

Return Value:

0: The function was successfully processed.

Other: The processing failed.

Refer to Chapter 6.7: "Error Code Definitions" for details of other returned values.

Examples:

```
float AI[12];
float fBuf[12];
char szSend[80];
char szReceive[80];
WORD wBuf[12];
WORD m_port=3;
WORD m_address=1;
WORD m_timeout=100;
WORD m_checksum=0;
Open_Com(COM3, 9600, Data8Bit, NonParity, OneStopBit);
wBuf[0] = m_port;
wBuf[1] = m_address;
wBuf[2] = 0x7017;
wBuf[3] = m_checksum;
wBuf[4] = m_timeout;
wBuf[6] = 1;
AnalogInAll (wBuf, fBuf, szSend, szReceive);
AI[0] = fBuf[0];
AI[0] = fBuf[1];
AI[0] = fBuf[2];
AI[0] = fBuf[3];
AI[0] = fBuf[4];
AI[0] = fBuf[5];
AI[0] = fBuf[6];
AI[0] = fBuf[7];
Close_Com(COM3);
```

Remark:

■ ThermocoupleOpen_7011

Description:

This function is used to detect the thermocouple state of I-7011 modules for the supporting type “J, K, T, E, R, S, B, N, C” is open or close. If the response value is “0”, thermocouple I-7011 is working in close state. If the response value is “1”, thermocouple I-7011 is working in open state. For more information please refer to user manual.

Syntax:

```
[ C ]  
WORD ThermocoupleOpen_7011(WORD wBuf[], float fBuf[],char szSend[],  
                             char szReceive[])
```

Parameter:

wBuf: WORD Input/Output argument talbe
wBuf[0] : [Input] COM port number, from 1 to 255
wBuf[1] : [Input] Module address, form 0x00 to 0xFF
wBuf[2] : [Input] Module ID, 0x7011
wBuf[3] : [Input] 0= Checksum disable; 1= Checksum enable
wBuf[4] : [Input] Timeout setting , normal=100 milliseconds
wBuf[5] : [Output] response value 0 → the thermocouple is close
 response value 1 → the thermocouple is open
wBuf[6] : [Input] 0 → no save to szSend & szReceive
 1 → Save to szSend & szReceive
fBuf : Not used.
szSend : [Input] Command string to be sent to I-7000 series modules.
szReceive : [Output] Result string receiving from I-7000 series modules .

Return Value:

0: The function was successfully processed.

Other: The processing failed.

Refer to Chapter 6.7: “Error Code Definitions” for details of other returned values.

Examples:

```
WORD state;  
float fBuf[12];  
char szSend[80];  
char szReceive[80];  
WORD wBuf[12];
```

```

WORD m_port=3;
WORD m_address=1;
WORD m_timeout=100;
WORD m_checksum=0;
Open_Com(COM3, 9600, Data8Bit, NonParity, OneStopBit);
wBuf[0] = m_port;
wBuf[1] = m_address;
wBuf[2] = 0x7011;
wBuf[3] = m_checksum;
wBuf[4] = m_timeout;
wBuf[5] = 0;
wBuf[6] = 1;
ThermocoupleOpen_7011(wBuf, fBuf, szSend, szReceive);
state = wBuf[5];
Close_Com(COM3);

```

Remark:

■ SetLedDisplay

Description:

This function is used to configure LED display for specified channel of I-7000 analog input serial modules.

Syntax:

[C]
WORD SetLedDisplay (WORD wBuf[], float fBuf[],char szSend[], char szReceive[])

Parameter:

wBuf: WORD Input/Output argument talbe

wBuf[0] : [Input] COM port number, from 1 to 255

wBuf[1] : [Input] Module address, form 0x00 to 0xFF

wBuf[2] : [Input] Module ID, 0x7013/16/33

wBuf[3] : [Input] 0= Checksum disable; 1= Checksum enable

wBuf[4] : [Input] Timeout setting , normal=100 milliseconds

wBuf[5] : [Input] Set display channel
wBuf[6] : [Input] 0 → no save to szSend & szReceive
 1 → Save to szSend & szReceive
fBuf : Not used.
szSend : [Input] Command string to be sent to I-7000 series modules.
szReceive : [Output] Result string receiving from I-7000 series modules .

Return Value:

0: The function was successfully processed.

Other: The processing failed.

Refer to Chapter 6.7: “Error Code Definitions” for details of other returned values.

Examples:

```
float fBuf[12];
char szSend[80];
char szReceive[80];
WORD wBuf[12];
WORD m_port=3;
WORD m_address=1;
WORD m_timeout=100;
WORD m_checksum=0;
Open_Com(COM3, 9600, Data8Bit, NonParity, OneStopBit);
wBuf[0] = m_port;
wBuf[1] = m_address;
wBuf[2] = 0x7033;
wBuf[3] = m_checksum;
wBuf[4] = m_timeout;
wBuf[5] = 1;           // Set channel 1 display
wBuf[6] = 1;
SetLedDisplay (wBuf, fBuf, szSend, szReceive);
Close_Com(COM3);
```

Remark:

■ GetLedDisplay

Description:

This function is used to get the current setting of the specified channel for LED display channel for specified channel of I-7000 analog input serial modules.

Syntax:

```
[ C ]  
WORD GetLedDisplay (WORD wBuf[], float fBuf[],char szSend[], char szReceive[])
```

Parameter:

wBuf: WORD Input/Output argument talbe
wBuf[0] : [Input] COM port number, from 1 to 255
wBuf[1] : [Input] Module address, form 0x00 to 0xFF
wBuf[2] : [Input] Module ID, 0x7013/16/33
wBuf[3] : [Input] 0= Checksum disable; 1= Checksum enable
wBuf[4] : [Input] Timeout setting , normal=100 milliseconds
wBuf[5] : [Output] Current channel for LED display
 0 = channel_0
 1 = channel_1
wBuf[6] : [Input] 0 → no save to szSend & szReceive
 1 → Save to szSend & szReceive
fBuf : Not used
szSend : [Input] Command string to be sent to I-7000 series modules.
szReceive : [Output] Result string receiving from I-7000 series modules .

Return Value:

0 is for Success
Not 0 is for Failure

Examples:

```
WORD led;  
float fBuf[12];  
char szSend[80];  
char szReceive[80];  
WORD wBuf[12];  
WORD m_port=3;  
WORD m_address=1;  
WORD m_timeout=100;  
WORD m_checksum=0;
```



```
Open_Com(COM3, 9600, Data8Bit, NonParity, OneStopBit);  
wBuf[0] = m_port;  
wBuf[1] = m_address;  
wBuf[2] = 0x7033;  
wBuf[3] = m_checksum;  
wBuf[4] = m_timeout;  
wBuf[6] = 1;  
GetLedDisplay (wBuf, fBuf, szSend, szReceive);  
Led = wBuf[5];  
Close_Com(COM3);
```

Remark:

6.3.2.2 I-8000 series modules

■ AnalogIn_8K

Description:

This function is used to obtain input value form I-8000 analog input series modules.

Syntax:

```
[ C ]  
WORD AnalogIn_8K(DWORD dwBuf[], float fBuf[],char szSend[], char szReceive[])
```

Parameter:

dwBuf: DWORD Input/Output argument talbe
dwBuf[0] : [Input] COM port number, from 1 to 255
dwBuf[1] : [Input] Module address, form 0x00 to 0xFF
dwBuf[2] : [Input] Module ID, 0x8017
dwBuf[3] : [Input] 0= Checksum disable; 1= Checksum enable
dwBuf[4] : [Input] Timeout setting , normal=100 milliseconds
dwBuf[5] : [Input] Channel number of analog input module
dwBuf[6] : [Input] 0 → no save to szSend & szReceive
 1 → Save to szSend & szReceive
dwBuf[7] : [Input] Slot number.
fBuf : Float Input/Ouput argument table.
fBuf[0] : [Output] Analog input value
szSend : [Input] Command string to be sent to I-8000 series modules.
szReceive : [Output] Result string receiving from I-8000 series modules.

Return Value:

0: The function was successfully processed.

Other: The processing failed.

Refer to Chapter 6.7: "Error Code Definitions" for details of other returned values.

Examples:

```
float AI;  
float fBuf[12];  
char szSend[80];  
char szReceive[80];  
DWORD dwBuf[12];  
DWORD m_port=3;  
DWORD m_address=1;
```

```

DWORD m_timeout=100;
DWORD m_checksum=0;
Open_Com(COM3, 9600, Data8Bit, NonParity, OneStopBit);
dwBuf[0] = m_port;
dwBuf[1] = m_address;
dwBuf[2] = 0x8017;
dwBuf[3] = m_checksum;
dwBuf[4] = m_timeout;
dwBuf[5] = 1;
dwBuf[6] = 1;
dwBuf[7] = 1;
AnalogIn_8K (dwBuf, fBuf, szSend, szReceive);
AI = fBuf[0];
Close_Com(COM3);

```

Remark:

■ AnalogInHex_8K

Description:

This function is used to obtain input value in “Hexadecimal” form I-8000 analog input series modules.

Syntax:

[C]
WORD AnalogInHex_8K(DWORD dwBuf[], float fBuf[],char szSend[], char szReceive[])

Parameter:

dwBuf:	DWORD Input/Output argument talbe
dwBuf[0] :	[Input] COM port number, from 1 to 255
dwBuf[1] :	[Input] Module address, form 0x00 to 0xFF
dwBuf[2] :	[Input] Module ID, 0x8017
dwBuf[3] :	[Input] 0= Checksum disable; 1= Checksum enable
dwBuf[4] :	[Input] Timeout setting , normal=100 milliseconds

dwBuf[5] : [Input] Channel number of analog input module
dwBuf[6] : [Input] 0 → no save to szSend & szReceive
 1 → Save to szSend &szReceive
dwBuf[7] : [Input] Slot number.
dwBuf[8] : [Output] The analog input value in Hex format.
fBuf : Not used.
szSend : [Input] Command string to be sent to I-8000 series modules.
szReceive : [Output] Result string receiving from I-8000 series modules.

Return Value:

0: The function was successfully processed.

Other: The processing failed.

Refer to Chapter 6.7: “Error Code Definitions” for details of other returned values.

Examples:

```
DWORD AI;  
float fBuf[12];  
char szSend[80];  
char szReceive[80];  
DWORD dwBuf[12];  
DWORD m_port=3;  
DWORD m_address=1;  
DWORD m_timeout=100;  
DWORD m_checksum=0;  
Open_Com(COM3, 9600, Data8Bit, NonParity, OneStopBit);  
dwBuf[0] = m_port;  
dwBuf[1] = m_address;  
dwBuf[2] = 0x8017;  
dwBuf[3] = m_checksum;  
dwBuf[4] = m_timeout;  
dwBuf[5] = 1;  
dwBuf[6] = 1;  
dwBuf[7] = 1;  
AnalogInHex_8K (dwBuf, fBuf, szSend, szReceive);  
AI = dwBuf[8];  
Close_Com(COM3);
```

Remark:

■ AnalogInFsr_8K

Description:

This function is used to obtain input value in “FSR” form I-8000 analog input series modules. The “FSR” means “Percent” format.

Syntax:

```
[ C ]  
WORD AnalogInFsr_8K(DWORD dwBuf[], float fBuf[],char szSend[],  
char szReceive[])
```

Parameter:

dwBuf: DWORD Input/Output argument talbe
dwBuf[0] : [Input] COM port number, from 1 to 255
dwBuf[1] : [Input] Module address, form 0x00 to 0xFF
dwBuf[2] : [Input] Module ID, 0x8017
dwBuf[3] : [Input] 0= Checksum disable; 1= Checksum enable
dwBuf[4] : [Input] Timeout setting , normal=100 milliseconds
dwBuf[5] : [Input] Channel number of analog input module
dwBuf[6] : [Input] 0 → no save to szSend &szReceive
 1 → Save to szSend &szReceive
dwBuf[7] : [Input] Slot number.
fBuf : Float input/Output argument table.
fBuf[0] : [Output] The analog input value.
szSend : [Input] Command string to be sent to I-8000 series modules.
szReceive : [Output] Result string receiving from I-8000 series modules.

Return Value:

0: The function was successfully processed.

Other: The processing failed.

Refer to Chapter 6.7: “Error Code Definitions” for details of other returned values.

Examples:

```
float AI;  
float fBuf[12];  
char szSend[80];  
char szReceive[80];  
DWORD dwBuf[12];  
DWORD m_port=3;
```

```
DWORD m_address=1;
DWORD m_timeout=100;
DWORD m_checksum=0;
Open_Com(COM3, 9600, Data8Bit, NonParity, OneStopBit);
dwBuf[0] = m_port;
dwBuf[1] = m_address;
dwBuf[2] = 0x8017;
dwBuf[3] = m_checksum;
dwBuf[4] = m_timeout;
dwBuf[5] = 1;
dwBuf[6] = 1;
dwBuf[7] = 1;
AnalogInFsr_8K (dwBuf, fBuf, szSend, szReceive);
AI = fBuf[0];
Close_Com(COM3);
```

Remark:

■ AnalogInAll_8K

Description:

This function is used to obtain input value of all channels form I-8000 analog input series modules.

Syntax:

```
[ C ]  
WORD AnalogInAll_8K(DWORD dwBuf[], float fBuf[], char szSend[],char szReceive[])
```

Parameter:

dwBuf: DWORD Input/Output argument talbe
dwBuf[0] : [Input] COM port number, from 1 to 255
dwBuf[1] : [Input] Module address, form 0x00 to 0xFF
dwBuf[2] : [Input] Module ID, 0x8017
dwBuf[3] : [Input] 0= Checksum disable; 1= Checksum enable
dwBuf[4] : [Input] Timeout setting , normal=100 milliseconds
dwBuf[6] : [Input] 0 → no save to szSend &szReceive
 1 → Save to szSend &szReceive
dwBuf[7] : [Input] Slot number.
fBuf : Float input/Output argument table.
fBuf[0] : [Output] Analog input value of channel 0.
fBuf[1] : [Output] Analog input value of channel 1.
fBuf[2] : [Output] Analog input value of channel 2.
fBuf[3] : [Output] Analog input value of channel 3.
fBuf[4] : [Output] Analog input value of channel 4.
fBuf[5] : [Output] Analog input value of channel 5.
fBuf[6] : [Output] Analog input value of channel 6.
fBuf[7] : [Output] Analog input value of channel 7.
szSend : [Input] Command string to be sent to I-8000 series modules.
szReceive : [Output] Result string receiving from I-8000 series modules.

Return Value:

0: The function was successfully processed.

Other: The processing failed.

Refer to Chapter 6.7: “Error Code Definitions” for details of other returned values.

Examples:

```
float AI[12];
float fBuf[12];
char szSend[80];
char szReceive[80];
DWORD dwBuf[12];
DWORD m_port=3;
DWORD m_address=1;
DWORD m_timeout=100;
DWORD m_checksum=0;
Open_Com(COM3, 9600, Data8Bit, NonParity, OneStopBit);
dwBuf[0] = m_port;
dwBuf[1] = m_address;
dwBuf[2] = 0x8017;
dwBuf[3] = m_checksum;
dwBuf[4] = m_timeout;
dwBuf[6] = 1;
dwBuf[7] = 1;
AnalogInAll_8K (dwBuf, fBuf, szSend, szReceive);
AI[0] = fBuf[0];
AI[1] = fBuf[1];
AI[2] = fBuf[2];
AI[3] = fBuf[3];
AI[4] = fBuf[4];
AI[5] = fBuf[5];
AI[6] = fBuf[6];
AI[7] = fBuf[7];
Close_Com(COM3);
```

Remark:

6.3.2.3 I-87000 series modules

■ AnalogIn_87K

Description:

This function is used to obtain input value form I-87000 series analog input modules.

Syntax:

```
[ C ]  
WORD AnalogIn_87K(DWORD dwBuf[], float fBuf[],char szSend[],char szReceive[])
```

Parameter:

dwBuf: DWORD Input/Output argument talbe
dwBuf[0] : [Input] COM port number, from 1 to 255
dwBuf[1] : [Input] Module address, form 0x00 to 0xFF
dwBuf[2] : [Input] Module ID, 0x87013/15/16/17/18/19
dwBuf[3] : [Input] 0= Checksum disable; 1= Checksum enable
dwBuf[4] : [Input] Timeout setting , normal=100 milliseconds
dwBuf[5] : [Input] Channel number for multi-channel
dwBuf[6] : [Input] 0 → no save to szSend & szReceive
 1 → Save to szSend & szReceive
fBuf : Float Input/Ouput argument table.
fBuf[0] : [Output] The analog input value return
szSend : [Input] Command string to be sent to I-87000 series modules.
szReceive : [Output] Result string receiving from I-87000 series modules .

Return Value:

0: The function was successfully processed.

Other: The processing failed.

Refer to Chapter 6.7: “Error Code Definitions” for details of other returned values.

Examples:

```
float AI;  
float fBuf[12];  
char szSend[80];  
char szReceive[80];  
DWORD dwBuf[12];  
DWORD m_port=3;  
DWORD m_address=1;  
DWORD m_timeout=100;
```

```

DWORD m_checksum=0;
Open_Com(COM3, 9600, Data8Bit, NonParity, OneStopBit);
dwBuf[0] = m_port;
dwBuf[1] = m_address;
dwBuf[2] = 0x87017;
dwBuf[3] = m_checksum;
dwBuf[4] = m_timeout;
dwBuf[5] = 1;
dwBuf[6] = 1;
AnalogIn_87K(dwBuf, fBuf, szSend, szReceive);
AI = fBuf[0];
Close_Com(COM3);

```

Remark:

■ **AnalogInHex_87K**

Description:

This function is used to obtain input value in “Hexadecimal” form I-87000 series analog input modules.

Syntax:

```

[ C ]
WORD AnalogInHex_87K(DWORD dwBuf[], float fBuf[],char szSend[],
char szReceive[])

```

Parameter:

- dwBuf: DWORD Input/Output argument talbe
- dwBuf[0] : [Input] COM port number, from 1 to 255
- dwBuf[1] : [Input] Module address, form 0x00 to 0xFF
- dwBuf[2] : [Input] Module ID, 0x87013/15/16/17/18/19
- dwBuf[3] : [Input] 0= Checksum disable; 1= Checksum enable
- dwBuf[4] : [Input] Timeout setting , normal=100 milliseconds
- dwBuf[5] : [Input] Channel number for multi-channel

dwBuf[6] : [Input] 0 → no save to szSend & szReceive
 1 → Save to szSend & szReceive
dwBuf[7] : [Output] The analog input value in “Hex” format.
fBuf : Not used.
szSend : [Input] Command string to be sent to I-87000 series modules.
szReceive : [Output] Result string receiving from I-87000 series modules .

Return Value:

0: The function was successfully processed.

Other: The processing failed.

Refer to Chapter 6.7: “Error Code Definitions” for details of other returned values.

Examples:

```
DWORD AI;  
float fBuf[12];  
char szSend[80];  
char szReceive[80];  
DWORD dwBuf[12];  
DWORD m_port=3;  
DWORD m_address=1;  
DWORD m_timeout=100;  
DWORD m_checksum=0;  
Open_Com(COM3, 9600, Data8Bit, NonParity, OneStopBit);  
dwBuf[0] = m_port;  
dwBuf[1] = m_address;  
dwBuf[2] = 0x87017;  
dwBuf[3] = m_checksum;  
dwBuf[4] = m_timeout;  
dwBuf[5] = 1;  
dwBuf[6] = 1;  
AnalogInHex_87K(dwBuf, fBuf, szSend, szReceive);  
AI = dwBuf[8];  
Close_Com(COM3);
```

Remark:

■ AnalogInFsr_87K

Description:

This function is used to obtain input value in “FSR” form I-87000 series analog input modules.

Syntax:

```
[ C ]  
WORD AnalogInFsr_87K(DWORD dwBuf[], float fBuf[],char szSend[],  
                    char szReceive[])
```

Parameter:

dwBuf: DWORD Input/Output argument talbe
dwBuf[0] : [Input] COM port number, from 1 to 255
dwBuf[1] : [Input] Module address, form 0x00 to 0xFF
dwBuf[2] : [Input] Module ID, 0x87013/15/16/17/18/19
dwBuf[3] : [Input] 0= Checksum disable; 1= Checksum enable
dwBuf[4] : [Input] Timeout setting , normal=100 milliseconds
dwBuf[5] : [Input] Channel number for multi-channel
dwBuf[6] : [Input] 0 → no save to szSend & szReceive
 1 → Save to szSend & szReceive
fBuf : Float Input/Ouput argument table.
fBuf[0] : [Output] The analog input value
szSend : [Input] Command string to be sent to I-87000 series modules.
szReceive : [Output] Result string receiving from I-87000 series modules .

Return Value:

0: The function was successfully processed.

Other: The processing failed.

Refer to Chapter 6.7: “Error Code Definitions” for details of other returned values.

Examples:

```
DWORD AI;  
float fBuf[12];  
char szSend[80];  
char szReceive[80];  
DWORD dwBuf[12];  
DWORD m_port=3;  
DWORD m_address=1;
```

```
DWORD m_timeout=100;
DWORD m_checksum=0;
Open_Com(COM3, 9600, Data8Bit, NonParity, OneStopBit);
dwBuf[0] = m_port;
dwBuf[1] = m_address;
dwBuf[2] = 0x87017;
dwBuf[3] = m_checksum;
dwBuf[4] = m_timeout;
dwBuf[5] = 1;
dwBuf[6] = 1;
AnalogInHex_87K(dwBuf, fBuf, szSend, szReceive);
AI = fBuf[0];
Close_Com(COM3);
```

Remark:

■ AnalogInAll_87K

Description:

This function is used to obtain input value of all channels form I-87000 series analog input modules.

Syntax:

```
[ C ]  
WORD AnalogInAll_87K(DWORD dwBuf[], float fBuf[],char szSend[],  
char szReceive[])
```

Parameter:

dwBuf: DWORD Input/Output argument talbe
dwBuf[0] : [Input] COM port number, from 1 to 255
dwBuf[1] : [Input] Module address, form 0x00 to 0xFF
dwBuf[2] : [Input] Module ID, 0x87013/15/16/17/18/19
dwBuf[3] : [Input] 0= Checksum disable; 1= Checksum enable
dwBuf[4] : [Input] Timeout setting , normal=100 milliseconds
dwBuf[6] : [Input] 0 → no save to szSend & szReceive
 1 → Save to szSend & szReceive
fBuf : Float Input/Ouput argument table.
fBuf[0] : [Output] Analog input value of channel 0
fBuf[1] : [Output] Analog input value of channel 1
fBuf[2] : [Output] Analog input value of channel 2
fBuf[3] : [Output] Analog input value of channel 3
fBuf[4] : [Output] Analog input value of channel 4
fBuf[5] : [Output] Analog input value of channel 5
fBuf[6] : [Output] Analog input value of channel 6
fBuf[7] : [Output] Analog input value of channel 7
szSend : [Input] Command string to be sent to I-87000 series modules.
szReceive : [Output] Result string receiving from I-87000 series modules .

Return Value:

0: The function was successfully processed.

Other: The processing failed.

Refer to Chapter 6.7: "Error Code Definitions" for details of other returned values.

Examples:

```
float AI[12];
DWORD AI;
float fBuf[12];
char szSend[80];
char szReceive[80];
DWORD dwBuf[12];
DWORD m_port=3;
DWORD m_address=1;
DWORD m_timeout=100;
DWORD m_checksum=0;
Open_Com(COM3, 9600, Data8Bit, NonParity, OneStopBit);
dwBuf[0] = m_port;
dwBuf[1] = m_address;
dwBuf[2] = 0x87017;
dwBuf[3] = m_checksum;
dwBuf[4] = m_timeout;
dwBuf[6] = 1;
AnalogInAll_87K(dwBuf, fBuf, szSend, szReceive);
AI[0] = fBuf[0];
AI[1] = fBuf[1];
AI[2] = fBuf[2];
AI[3] = fBuf[3];
AI[4] = fBuf[4];
AI[5] = fBuf[5];
AI[6] = fBuf[6];
AI[7] = fBuf[7];
Close_Com(COM3);
```

Remark:

6.4 Analog Output Functions

6.4.1 For I-8000 modules via parallel port

■ I8024_Initial

Description:

This function is used to initialize the I-8024W module in the specified slot. You must implement this function before you try to use the other I-8024 functions.

Syntax:

```
void I8024_Initial(int slot) [ C ]
```

Parameter:

slot : [Input] Specifies the slot where the I/O module is inserted. (Range: 1 to 8)

Return Value:

None

Examples:

```
int slot=1;
I8024_Initial(slot);
// The I-8024W is inserted in slot 1 of LP-8x21 and initializes the I-8024W module.
```

Remark:

This function can be applied on module: I-8024W.

■ I8024_VoltageOut

Description:

This function is used to send the voltage float value to the I-8024W module with the specified channel and slot in the LP-8x21 system.

Syntax:

```
[ C ]  
void I8024_VoltageOut(int slot, int ch, float data)
```

Parameter:

slot : [Input] Specifies the slot where the I/O module is inserted. (Range: 1 to 8)
ch : [Input] Output channel (Range: 0 to 3)
data : [Input] Output data with engineering unit (Voltage Output: -10 to +10)

Return Value:

None

Examples:

```
int slot=1, ch=0;  
float data=3.0f;  
I8024_VoltageOut(slot, ch, data);  
//The I-8024WW module output the 3.0V voltage from the channel 0.
```

Remark:

This function can be applied on module: I-8024W.

■ I8024_CurrentOut

Description:

This function is used to initialize the I-8024W module in the specified slot for current output. Users must call this function before trying to use the other I-8024 W functions for current output.

Syntax:

```
[ C ]  
void I8024_CurrentOut(int slot, int ch, float cdata)
```

Parameter:

slot : [Input] Specifies the slot where the I/O module is inserted. (Range: 1 to 8)
ch : [Input] Output channel (Range: 0 to 3)
cdata : [Input] Output data with engineering unit (Current Output: 0 to 20 mA)

Return Value:

None

Examples:

```
int slot=1, ch=0;  
float cdata=10.0f;  
I8024_CurrentOut(slot, ch, data);  
// Output the 10.0mA current from the channel 0 of I-8024W module.
```

Remark:

This function can be applied on module: I-8024W.

■ I8024_VoltageHexOut

Description:

This function is used to send the voltage value in the Hex format to the specified channel in the I-8024W module, which is inserted in the slot in the LP-8x21 system.

Syntax:

```
[ C ]  
void I8024_VoltageHexOut(int slot, int ch, int hdata)
```

Parameter:

slot : [Input] Specifies the slot where the I/O module is inserted. (Range: 1 to 8)
ch : [Input] Output channel (Range: 0 to 3)
hdata : [Input] Output data with hexadecimal
(data range: 0h to 3FFFh → Voltage Output: -10 to 10V)

Return Value:

None

Examples:

```
int slot=1, ch=0; data=0x3000;  
I8024_VoltageHexOut(slot, ch, data);  
// The I-8024W module output the 5.0V voltage from the channel 0.
```

Remark:

This function can be applied on module: I-8024W.

■ I8024_CurrentHexOut

Description:

This function is used to send the current value in the Hex format to the specified channel in the analog output module I-8024W, which is plugged into the slot in the LP-8x21 system.

Syntax:

```
[ C ]  
void I8024_CurrentHexOut(int slot, int ch, int hdata)
```

Parameter:

slot : [Input] Specifies the slot where the I/O module is inserted. (Range: 1 to 8)
ch : [Input] Output channel (Range: 0 to 3)
hdata : [Input] Output data with hexadecimal
(data range: 0h to 3FFFh → Current Output: 0 to +20mA)

Return Value:

None

Examples:

```
int slot=1, ch=0; data=0x2000;  
I8024_CurrentHexOut(slot, ch, data);  
// Output the 10.0mA current from the channel 0 of I-8024W module.
```

Remark:

This function can be applied on module: I-8024W.

6.4.2 For I-7000/I-8000/I-87000 modules via serial port

6.4.2.1 I-7000 series modules

■ AnalogOut

Description:

This function is used to obtain analog value from analog output module of I-7000 series modules.

Syntax:

```
[ C ]  
WORD AnalogOut(WORD wBuf[], float fBuf[],char szSend[], char szReceive[])
```

Parameter:

wBuf: WORD Input/Output argument talbe
wBuf[0] : [Input] COM port number, from 1 to 255
wBuf[1] : [Input] Module address, form 0x00 to 0xFF
wBuf[2] : [Input] Module ID, 0x7016/21/22/24
wBuf[3] : [Input] 0= Checksum disable; 1= Checksum enable
wBuf[4] : [Input] Timeout setting , normal=100 milliseconds
wBuf[5] : [Input] The analog output channel number
wBuf[6] : [Input] 0 → no save to szSend &szReceive
 1 → Save to szSend &szReceive
fBuf : Float Input/Ouput argument table.
fBuf[0] : [Input] Analog output value
szSend : [Input] Command string to be sent to I-7000 series modules.
szReceive : [Output] Result string receiving from I-7000 series modules.

Return Value:

0: The function was successfully processed.

Other: The processing failed.

Refer to Chapter 6.7: "Error Code Definitions" for details of other returned values.

Examples:

```
float fBuf[12];  
char szSend[80];  
char szReceive[80];  
WORD wBuf[12];  
WORD m_port=3;
```

```
WORD m_address=1;
WORD m_timeout=100;
WORD m_checksum=0;
Open_Com(COM3, 9600, Data8Bit, NonParity, OneStopBit);
wBuf[0] = m_port;
wBuf[1] = m_address;
wBuf[2] = 0x7016;
wBuf[3] = m_checksum;
wBuf[4] = m_timeout;
// wBuf[5] = 0;                // I-7016 no used
wBuf[6] = 1;
fBuf[0] = 3.5                // Excitation Voltage output +3.5V
AnalogOut (wBuf, fBuf, szSend, szReceive); "
Close_Com(COM3);
```

Remark:

■ AnalogOutReadBack

Description:

This function is used to obtain read back the analog value of analog output modules of I-7000 series modules. There are two types of read back functions, as described in the following :

1. Last value is read back by \$AA6 command
2. Analog output of current path is read back by \$AA8 command

Syntax:

```
[ C ]  
WORD AnalogOutReadBack(WORD wBuf[], float fBuf[],char szSend[],  
                        char szReceive[])
```

Parameter:

wBuf: WORD Input/Output argument talbe
wBuf[0] : [Input] COM port number, from 1 to 255
wBuf[1] : [Input] Module address, form 0x00 to 0xFF
wBuf[2] : [Input] Module ID, 0x7016/21/22/24
wBuf[3] : [Input] 0= Checksum disable; 1= Checksum enable
wBuf[4] : [Input] Timeout setting , normal=100 milliseconds
wBuf[5] : [Input] 0 : command \$AA6 read back
 1 : command \$AA8 read back

Note 1) When the module is I-7016: Don't care.
2) When the module is I-7021/22, analog output of current path read back (\$AA8)
3) When the module is I-7024, the updating value in a specific Slew rate (\$AA8)
(For more information, please refer to I-7021/22/24 manual)

wBuf[6] : [Input] 0 → no save to szSend &szReceive
 1 → Save to szSend &szReceive
wBuf[7] : [Input] The analog output channel No. (0 to 3) of module I-7024
 No used for single analog output module
fBuf : Float Input/Ouput argument table.
fBuf[0] : [Output] Analog output read back value
szSend : [Input] Command string to be sent to I-7000 series modules.
szReceive : [Output] Result string receiving from I-7000 series modules.

Return Value:

0: The function was successfully processed.

Other: The processing failed.

Refer to Chapter 6.7: “Error Code Definitions” for details of other returned values.

Examples:

```
Float Volt;
float fBuf[12];
char szSend[80];
char szReceive[80];
WORD wBuf[12];
WORD m_port=3;
WORD m_address=1;
WORD m_timeout=100;
WORD m_checksum=0;
Open_Com(COM3, 9600, Data8Bit, NonParity, OneStopBit);
wBuf[0] = m_port;
wBuf[1] = m_address;
wBuf[2] = 0x7021;
wBuf[3] = m_checksum;
wBuf[4] = m_timeout;
wBuf[5] = 0;                // $AA6 command
wBuf[6] = 1;
wBuf[7] = 1;
AnalogOutReadBack (wBuf, fBuf, szSend, szReceive);
Volt = fBuf[0];            // Receive: “!01+2.57” excitation voltage , Volt=2.57
Close_Com(COM3);
```

Remark:

■ AnalogOutHex

Description:

This function is used to obtain analog value of analog output modules through Hex format.

Syntax:

```
[ C ]  
WORD AnalogOutHex(WORD wBuf[], float fBuf[],char szSend[], char szReceive[])
```

Parameter:

wBuf: WORD Input/Output argument talbe
wBuf[0] : [Input] COM port number, from 1 to 255
wBuf[1] : [Input] Module address, form 0x00 to 0xFF
wBuf[2] : [Input] Module ID, 0x7021/21P/22
wBuf[3] : [Input] 0= Checksum disable; 1= Checksum enable
wBuf[4] : [Input] Timeout setting , normal=100 milliseconds
wBuf[5] : [Input] The analog output channel number
(No used for single analog output module)
wBuf[6] : [Input] 0 → no save to szSend &szReceive
1 → Save to szSend &szReceive
wBuf[7] : [Input] Analog output value in Hexadecimal data format
fBuf : Not used.
szSend : [Input] Command string to be sent to I-7000 series modules.
szReceive : [Output] Result string receiving from I-7000 series modules.

Return Value:

0: The function was successfully processed.

Other: The processing failed.

Refer to Chapter 6.7: "Error Code Definitions" for details of other returned values.

Examples:

```
float fBuf[12];  
char szSend[80];  
char szReceive[80];  
WORD wBuf[12];  
WORD m_port=3;  
WORD m_address=1;  
WORD m_timeout=100;  
WORD m_checksum=0;  
Open_Com(COM3, 9600, Data8Bit, NonParity, OneStopBit);
```

```

wBuf[0] = m_port;
wBuf[1] = m_address;
wBuf[2] = 0x7022;
wBuf[3] = m_checksum;
wBuf[4] = m_timeout;
wBuf[5] = 1;           // channel 1
wBuf[6] = 1;
wBuf[7] = 0x250
AnalogOutHex (wBuf, fBuf, szSend, szReceive);
Close_Com(COM3);

```

Remark:

■ **AnalogOutFsr**

Description:

This function is used to obtain analog value of analog output modules through % of span data format. This function only can be used after analog output modules is set as “FSR” output mode.

Syntax:

[C]

WORD AnalogOutFsr(**WORD** wBuf[], float fBuf[],char szSend[], char szReceive[])

Parameter:

- wBuf: WORD Input/Output argument talbe
- wBuf[0] : [Input] COM port number, from 1 to 255
- wBuf[1] : [Input] Module address, form 0x00 to 0xFF
- wBuf[2] : [Input] Module ID, 0x7021/21P/22
- wBuf[3] : [Input] 0= Checksum disable; 1= Checksum enable
- wBuf[4] : [Input] Timeout setting , normal=100 milliseconds
- wBuf[5] : [Input] The analog output channel number

(No used for single analog output module)

wBuf[6] : [Input] 0 → no save to szSend &szReceive
 1 → Save to szSend &szReceive

fBuf : Float Input/Output argument table.

FBuf[0] : [Input] Analog output value in % of Span data format.

szSend : [Input] Command string to be sent to I-7000 series modules.

szReceive : [Output] Result string receiving from I-7000 series modules.

Return Value:

0: The function was successfully processed.

Other: The processing failed.

Refer to Chapter 6.7: “Error Code Definitions” for details of other returned values.

Examples:

```
float fBuf[12];
char szSend[80];
char szReceive[80];
WORD wBuf[12];
WORD m_port=3;
WORD m_address=1;
WORD m_timeout=100;
WORD m_checksum=0;
Open_Com(COM3, 9600, Data8Bit, NonParity, OneStopBit);
wBuf[0] = m_port;
wBuf[1] = m_address;
wBuf[2] = 0x7022;
wBuf[3] = m_checksum;
wBuf[4] = m_timeout;
wBuf[5] = 1;           // channel 1
wBuf[6] = 1;
fBuf[0] = 50
AnalogOutFsr (wBuf, fBuf, szSend, szReceive);
Close_Com(COM3);
```

Remark:

■ AnalogOutReadBackHex

Description:

This function is used to obtain read back the analog value of analog output modules in Hex format for I-7000 series modules. There are two types of read back functions, as described in the following :

1. Last value is read back by \$AA6 command
2. Analog output of current path is read back by \$AA8 command

Syntax:

```
[ C ]  
WORD AnalogOutReadBackHex(WORD wBuf[], float fBuf[],char szSend[],  
                           char szReceive[])
```

Parameter:

wBuf: WORD Input/Output argument talbe

wBuf[0] : [Input] COM port number, from 1 to 255

wBuf[1] : [Input] Module address, form 0x00 to 0xFF

wBuf[2] : [Input] Module ID, 0x7021/21P/22

wBuf[3] : [Input] 0= Checksum disable; 1= Checksum enable

wBuf[4] : [Input] Timeout setting , normal=100 milliseconds

wBuf[5] : [Input] 0 : command \$AA6 read back
1 : command \$AA8 read back

wBuf[6] : [Input] 0 → no save to szSend &szReceive
1 → Save to szSend &szReceive

wBuf[7] : [Input] The analog output channel No.
No used for single analog output module

wBuf[9] : [Output] Analog output value in Hexadecimal data format.

fBuf : Not used.

szSend : [Input] Command string to be sent to I-7000 series modules.

szReceive : [Output] Result string receiving from I-7000 series modules.

Return Value:

0: The function was successfully processed.

Other: The processing failed.

Refer to Chapter 6.7: "Error Code Definitions" for details of other returned values.

Examples:

```
WORD Volt;
float fBuf[12];
char szSend[80];
char szReceive[80];
WORD wBuf[12];
WORD m_port=3;
WORD m_address=1;
WORD m_timeout=100;
WORD m_checksum=0;
Open_Com(COM3, 9600, Data8Bit, NonParity, OneStopBit);
wBuf[0] = m_port;
wBuf[1] = m_address;
wBuf[2] = 0x7021;
wBuf[3] = m_checksum;
wBuf[4] = m_timeout;
wBuf[5] = 0;                // command $AA6
wBuf[6] = 1;
wBuf[7] = 0;
AnalogOutReadBackHex (wBuf, fBuf, szSend, szReceive);
Volt = wBuf[9];
Close_Com(COM3);
```

Remark:

■ AnalogOutReadBackFsr

Description:

This function is used to obtain read back the analog value of analog output modules through % of span data format for I-7000 series modules. There are two types of read back functions, as described in the following :

1. Last value is read back by \$AA6 command
2. Analog output of current path is read back by \$AA8 command

Syntax:

```
[ C ]  
WORD AnalogOutReadBackFsr(WORD wBuf[], float fBuf[],char szSend[],  
char szReceive[])
```

Parameter:

wBuf: WORD Input/Output argument table
wBuf[0] : [Input] COM port number, from 1 to 255
wBuf[1] : [Input] Module address, form 0x00 to 0xFF
wBuf[2] : [Input] Module ID, 0x7021/21P/22
wBuf[3] : [Input] 0= Checksum disable; 1= Checksum enable
wBuf[4] : [Input] Timeout setting , normal=100 milliseconds
wBuf[5] : [Input] 0 : command \$AA6 read back
 1 : command \$AA8 read back
wBuf[6] : [Input] 0 → no save to szSend &szReceive
 1 → Save to szSend &szReceive
wBuf[7] : [Input] The analog output channel No.
 No used for single analog output module
fBuf : Float input/output argument table.
fBuf[0] : [Output] Analog output value in % Span data format.
szSend : [Input] Command string to be sent to I-7000 series modules.
szReceive : [Output] Result string receiving from I-7000 series modules.

Return Value:

0: The function was successfully processed.

Other: The processing failed.

Refer to Chapter 6.7: "Error Code Definitions" for details of other returned values.

Examples:

```
float Volt;
float fBuf[12];
char szSend[80];
char szReceive[80];
WORD wBuf[12];
WORD m_port=3;
WORD m_address=1;
WORD m_timeout=100;
WORD m_checksum=0;
Open_Com(COM3, 9600, Data8Bit, NonParity, OneStopBit);
wBuf[0] = m_port;
wBuf[1] = m_address;
wBuf[2] = 0x7021;
wBuf[3] = m_checksum;
wBuf[4] = m_timeout;
wBuf[5] = 0;                // command $AA6
wBuf[6] = 1;
wBuf[7] = 0;
AnalogOutReadBackFsr (wBuf, fBuf, szSend, szReceive);
Volt = fBuf[0];
Close_Com(COM3);
```

Remark:

6.4.2.2 I-8000 series modules

■ AnalogOut_8K

Description:

This function is used to obtain analog value of analog output module for I-8000 series modules.

Syntax:

```
[ C ]  
WORD AnalogOut_8K(DWORD dwBuf[], float fBuf[],char szSend[], char szReceive[])
```

Parameter:

dwBuf: DWORD Input/Output argument talbe
dwBuf[0] : [Input] COM port number, from 1 to 255
dwBuf[1] : [Input] Module address, form 0x00 to 0xFF
dwBuf[2] : [Input] Module ID, 0x8024
dwBuf[3] : [Input] 0= Checksum disable; 1= Checksum enable
dwBuf[4] : [Input] Timeout setting , normal=100 milliseconds
dwBuf[5] : [Input] The defined analog output channel No.
dwBuf[6] : [Input] 0 → no save to szSend &szReceive
 1 → Save to szSend &szReceive
dwBuf[7] : [Input] Slot number
fBuf : Float Input/Ouput argument table.
fBuf[0] : [Input] Analog output value
szSend : [Input] Command string to be sent to I-8000 series modules.
szReceive : [Output] Result string receiving from I-8000 series modules.

Return Value:

0: The function was successfully processed.

Other: The processing failed.

Refer to Chapter 6.7: "Error Code Definitions" for details of other returned values.

Examples:

```
float fBuf[12];  
char szSend[80];  
char szReceive[80];  
DWORD dwBuf[12];  
DWORD m_port=3;  
DWORD m_address=1;
```



```

DWORD m_timeout=100;
DWORD m_checksum=0;
Open_Com(COM3, 9600, Data8Bit, NonParity, OneStopBit);
dwBuf[0] = m_port;
dwBuf[1] = m_address;
dwBuf[2] = 0x8024;
dwBuf[3] = m_checksum;
dwBuf[4] = m_timeout;
dwBuf[5] = 1;
dwBuf[6] = 1;
dwBuf[7] = 1;
fBuf[0] = 2.55
AnalogOut_8K(dwBuf, fBuf, szSend, szReceive);
Close_Com(COM3);

```

Remark:

■ **AnalogOutReadBack_8K**

Description:

This function is used to read back the analog value of analog output module for I-8000 series modules.

Syntax:

[C]

WORD AnalogOutReadBack_8K(DWORD dwBuf[], float fBuf[],char szSend[],
char szReceive[])

Parameter:

- dwBuf: DWORD Input/Output argument talbe
- dwBuf[0] : [Input] COM port number, from 1 to 255
- dwBuf[1] : [Input] Module address, form 0x00 to 0xFF
- dwBuf[2] : [Input] Module ID, 0x8024
- dwBuf[3] : [Input] 0= Checksum disable; 1= Checksum enable
- dwBuf[4] : [Input] Timeout setting , normal=100 milliseconds
- dwBuf[5] : [Input] The defined analog output channel No.

dwBuf[6] : [Input] 0 → no save to szSend &szReceive
 1 → Save to szSend &szReceive
dwBuf[7] : [Input] Slot number
fBuf : Float Input/Output argument table.
fBuf[0] : [Input] Analog output value
szSend : [Input] Command string to be sent to I-8000 series modules.
szReceive : [Output] Result string receiving from I-8000 series modules.

Return Value:

0: The function was successfully processed.

Other: The processing failed.

Refer to Chapter 6.7: “Error Code Definitions” for details of other returned values.

Examples:

```
float Valot;
float fBuf[12];
char szSend[80];
char szReceive[80];
DWORD dwBuf[12];
DWORD m_port=3;
DWORD m_address=1;
DWORD m_timeout=100;
DWORD m_checksum=0;
Open_Com(COM3, 9600, Data8Bit, NonParity, OneStopBit);
dwBuf[0] = m_port;
dwBuf[1] = m_address;
dwBuf[2] = 0x8024;
dwBuf[3] = m_checksum;
dwBuf[4] = m_timeout;
dwBuf[5] = 1;
dwBuf[6] = 1;
dwBuf[7] = 1;
AnalogOutReadBack_8K(dwBuf, fBuf, szSend, szReceive);
Volt = fBuf[0];
Close_Com(COM3);
```

Remark:

■ ReadConfigurationStatus_8K

Description:

This function is used to read configuration status of analog output module for I-8000 series modules.

Syntax:

```
[ C ]  
WORD ReadConfigurationStatus_8K(DWORD dwBuf[], float fBuf[],char szSend[],  
                                char szReceive[])
```

Parameter:

dwBuf: DWORD Input/Output argument talbe
dwBuf[0] : [Input] COM port number, from 1 to 255
dwBuf[1] : [Input] Module address, form 0x00 to 0xFF
dwBuf[2] : [Input] Module ID, 0x8024
dwBuf[3] : [Input] 0= Checksum disable; 1= Checksum enable
dwBuf[4] : [Input] Timeout setting , normal=100 milliseconds
dwBuf[5] : [Input] The defined analog output channel No.
dwBuf[6] : [Input] 0 → no save to szSend &szReceive
 1 → Save to szSend &szReceive
dwBuf[7] : [Input] Slot number
dwBuf[8] : [Output] Output range: 0x30, 0x31,0x32
dwBuf[9] : [Output] Slew rate
fBuf : Not used.
szSend : [Input] Command string to be sent to I-8000 series modules.
szReceive : [Output] Result string receiving from I-8000 series modules.

Return Value:

0: The function was successfully processed.

Other: The processing failed.

Refer to Chapter 6.7: "Error Code Definitions" for details of other returned values.

Examples:

```
float fBuf[12];  
char szSend[80];  
char szReceive[80];  
DWORD Status;  
DWORD Rate;  
DWORD dwBuf[12];
```

```

DWORD m_port=3;
DWORD m_address=1;
DWORD m_timeout=100;
DWORD m_checksum=0;
Open_Com(COM3, 9600, Data8Bit, NonParity, OneStopBit);
dwBuf[0] = m_port;
dwBuf[1] = m_address;
dwBuf[2] = 0x8024;
dwBuf[3] = m_checksum;
dwBuf[4] = m_timeout;
dwBuf[5] = 1;
dwBuf[6] = 1;
dwBuf[7] = 1;
ReadConfigurationStatus_8K (dwBuf, fBuf, szSend, szReceive);
Status = dwBuf[8];
Rate = dwBuf[9];
Close_Com(COM3);

```

Remark:

■ **SetStartUpValue_8K**

Description:

This function is used to setting start-up value of analog output module for I-8000 series modules.

Syntax:

```

[ C ]
WORD SetStartUpValue_8K(DWORD dwBuf[], float fBuf[],char szSend[],
char szReceive[])

```

Parameter:

- dwBuf: DWORD Input/Output argument talbe
- dwBuf[0] : [Input] COM port number, from 1 to 255
- dwBuf[1] : [Input] Module address, form 0x00 to 0xFF
- dwBuf[2] : [Input] Module ID, 0x8024

dwBuf[3] : [Input] 0= Checksum disable; 1= Checksum enable
dwBuf[4] : [Input] Timeout setting , normal=100 milliseconds
dwBuf[5] : [Input] The defined analog output channel No.
dwBuf[6] : [Input] 0 → no save to szSend &szReceive
 1 → Save to szSend &szReceive
dwBuf[7] : [Input] Slot number
fBuf : Not used.
szSend : [Input] Command string to be sent to I-8000 series modules.
szReceive : [Output] Result string receiving from I-8000 series modules.

Return Value:

0: The function was successfully processed.

Other: The processing failed.

Refer to Chapter 6.7: “Error Code Definitions” for details of other returned values.

Examples:

```
float fBuf[12];  
char szSend[80];  
char szReceive[80];  
DWORD dwBuf[12];  
DWORD m_port=3;  
DWORD m_address=1;  
DWORD m_timeout=100;  
DWORD m_checksum=0;  
Open_Com(COM3, 9600, Data8Bit, NonParity, OneStopBit);  
dwBuf[0] = m_port;  
dwBuf[1] = m_address;  
dwBuf[2] = 0x8024;  
dwBuf[3] = m_checksum;  
dwBuf[4] = m_timeout;  
dwBuf[5] = 1;  
dwBuf[6] = 1;  
dwBuf[7] = 1;  
SetStartUpValue_8K(dwBuf, fBuf, szSend, szReceive);  
Close_Com(COM3);
```

Remark:

■ SetStartUpValue_8K

Description:

This function is used to read start-up value of analog output module for I-8000 series modules.

Syntax:

```
[ C ]  
WORD ReadStartUpValue_8K(DWORD dwBuf[], float fBuf[],char szSend[],  
char szReceive[])
```

Parameter:

dwBuf: DWORD Input/Output argument talbe
dwBuf[0] : [Input] COM port number, from 1 to 255
dwBuf[1] : [Input] Module address, form 0x00 to 0xFF
dwBuf[2] : [Input] Module ID, 0x8024
dwBuf[3] : [Input] 0= Checksum disable; 1= Checksum enable
dwBuf[4] : [Input] Timeout setting , normal=100 milliseconds
dwBuf[5] : [Input] The defined analog output channel No.
dwBuf[6] : [Input] 0 → no save to szSend &szReceive
 1 → Save to szSend &szReceive
dwBuf[7] : [Input] Slot number
fBuf : Float input/output argument table.
fBuf[0] : [Output] Start-Up value.
szSend : [Input] Command string to be sent to I-8000 series modules.
szReceive : [Output] Result string receiving from I-8000 series modules.

Return Value:

0: The function was successfully processed.

Other: The processing failed.

Refer to Chapter 6.7: "Error Code Definitions" for details of other returned values.

Examples:

```
float StartUp;  
float fBuf[12];  
char szSend[80];  
char szReceive[80];  
DWORD dwBuf[12];  
DWORD m_port=3;  
DWORD m_address=1;
```

```
DWORD m_timeout=100;
DWORD m_checksum=0;
Open_Com(COM3, 9600, Data8Bit, NonParity, OneStopBit);
dwBuf[0] = m_port;
dwBuf[1] = m_address;
dwBuf[2] = 0x8024;
dwBuf[3] = m_checksum;
dwBuf[4] = m_timeout;
dwBuf[5] = 1;
dwBuf[6] = 1;
dwBuf[7] = 1;
ReadStartUpValue_8K(dwBuf, fBuf, szSend, szReceive);
StartUp = fBuf[0];
Close_Com(COM3);
```

Remark:

■ AnalogOutReadBack_8K

Description:

This function is used to read back the analog value of analog output module for I-8000 series modules.

Syntax:

```
[ C ]  
WORD AnalogOutReadBack_8K(DWORD dwBuf[], float fBuf[],char szSend[],  
char szReceive[])
```

Parameter:

dwBuf: DWORD Input/Output argument talbe
dwBuf[0] : [Input] COM port number, from 1 to 255
dwBuf[1] : [Input] Module address, form 0x00 to 0xFF
dwBuf[2] : [Input] Module ID, 0x8024
dwBuf[3] : [Input] 0= Checksum disable; 1= Checksum enable
dwBuf[4] : [Input] Timeout setting , normal=100 milliseconds
dwBuf[5] : [Input] The defined analog output channel No.
dwBuf[6] : [Input] 0 → no save to szSend &szReceive
 1 → Save to szSend &szReceive
dwBuf[7] : [Input] Slot number
fBuf : Float Input/Ouput argument table.
fBuf[0] : [Input] Analog output value
szSend : [Input] Command string to be sent to I-8000 series modules.
szReceive : [Output] Result string receiving from I-8000 series modules.

Return Value:

0: The function was successfully processed.

Other: The processing failed.

Refer to Chapter 6.7: "Error Code Definitions" for details of other returned values.

Examples:

```
float Volt;  
float fBuf[12];  
char szSend[80];  
char szReceive[80];  
DWORD dwBuf[12];  
DWORD m_port=3;  
DWORD m_address=1;
```



```
DWORD m_timeout=100;
DWORD m_checksum=0;
Open_Com(COM3, 9600, Data8Bit, NonParity, OneStopBit);
dwBuf[0] = m_port;
dwBuf[1] = m_address;
dwBuf[2] = 0x8024;
dwBuf[3] = m_checksum;
dwBuf[4] = m_timeout;
dwBuf[5] = 1;
dwBuf[6] = 1;
dwBuf[7] = 1;
AnalogOutReadBack_8K(dwBuf, fBuf, szSend, szReceive);
Volt = fBuf[0];
Close_Com(COM3);
```

Remark:

6.4.2.3 I-87000 series modules

■ AnalogOut_87K

Description:

This function is used to output input value form I-87000 series analog input modules.

Syntax:

```
[ C ]  
WORD AnalogOut_87K(DWORD dwBuf[], float fBuf[],char szSend[],  
                  char szReceive[])
```

Parameter:

dwBuf: DWORD Input/Output argument talbe
dwBuf[0] : [Input] COM port number, from 1 to 255
dwBuf[1] : [Input] Module address, form 0x00 to 0xFF
dwBuf[2] : [Input] Module ID, 0x87024
dwBuf[3] : [Input] 0= Checksum disable; 1= Checksum enable
dwBuf[4] : [Input] Timeout setting , normal=100 milliseconds
dwBuf[5] : [Input] Channel number for multi-channel
dwBuf[6] : [Input] 0 → no save to szSend &szReceive
 1 → Save to szSend &szReceive
fBuf : Float Input/Ouput argument table.
fBuf[0] : [Output] The analog output value
szSend : [Input] Command string to be sent to I-87000 series modules.
szReceive : [Output] Result string receiving from I-87000 series modules .

Return Value:

0: The function was successfully processed.

Other: The processing failed.

Refer to Chapter 6.7: “Error Code Definitions” for details of other returned values.

Examples:

```
float fBuf[12];  
char szSend[80];  
char szReceive[80];  
DWORD dwBuf[12];  
DWORD m_port=3;  
DWORD m_address=1;  
DWORD m_timeout=100;  
DWORD m_checksum=0;
```

```
Open_Com(COM3, 9600, Data8Bit, NonParity, OneStopBit);
dwBuf[0] = m_port;
dwBuf[1] = m_address;
dwBuf[2] = 0x87024;
dwBuf[3] = m_checksum;
dwBuf[4] = m_timeout;
dwBuf[5] = 1;
dwBuf[6] = 1;
fBuf[0] = 2.55;          //+2.55V
AnalogOut_87K(dwBuf, fBuf, szSend, szReceive);
Close_Com(COM3);
```

Remark:

■ AnalogOutReadBack_87K

Description:

This function is used to read back the analog value of analog output module for I-87000 series modules. There are two types of read back functions, as described in the following:

1. Last value is read back by \$AA6 command
2. Analog output of current path is read back by \$AA8 command

Syntax:

[C]

WORD AnalogOutReadBack_87K(DWORD dwBuf[], float fBuf[],char szSend[],
char szReceive[])

Parameter:

dwBuf: DWORD Input/Output argument talbe

dwBuf[0] : [Input] COM port number, from 1 to 255

dwBuf[1] : [Input] Module address, form 0x00 to 0xFF

dwBuf[2] : [Input] Module ID, 0x87024

dwBuf[3] : [Input] 0= Checksum disable; 1= Checksum enable

dwBuf[4] : [Input] Timeout setting , normal=100 milliseconds

dwBuf[5] : [Input] The defined analog output channel No.

dwBuf[6] : [Input] 0 → no save to szSend &szReceive
 1 → Save to szSend &szReceive

fBuf : Float Input/Ouput argument table.

fBuf[0] : [Output] Analog output read back value

szSend : [Input] Command string to be sent to I-87000 series modules.

szReceive : [Output] Result string receiving from I-87000 series modules.

Return Value:

0: The function was successfully processed.

Other: The processing failed.

Refer to Chapter 6.7: “Error Code Definitions” for details of other returned values.

Examples:

```
float Volt;  
float fBuf[12];  
char szSend[80];  
char szReceive[80];  
DWORD dwBuf[12];
```

```

DWORD m_port=3;
DWORD m_address=1;
DWORD m_timeout=100;
DWORD m_checksum=0;
Open_Com(COM3, 9600, Data8Bit, NonParity, OneStopBit);
dwBuf[0] = m_port;
dwBuf[1] = m_address;
dwBuf[2] = 0x87024;
dwBuf[3] = m_checksum;
dwBuf[4] = m_timeout;
dwBuf[5] = 1;
dwBuf[6] = 1;
AnalogOutReadBack_87K (dwBuf, fBuf, szSend, szReceive);
Volt = fBuf[0];
Close_Com(COM3);

```

Remark:

■ **ReadConfigurationStatus_87K**

Description:

This function is used to read configuration status of analog output module for I-87000 series modules.

Syntax:

<p>[C]</p> <p>WORD ReadConfigurationStatus_87K(DWORD dwBuf[], float fBuf[],char szSend[], char szReceive[])</p>
--

Parameter:

- dwBuf: DWORD Input/Output argument talbe
- dwBuf[0] : [Input] COM port number, from 1 to 255
- dwBuf[1] : [Input] Module address, form 0x00 to 0xFF
- dwBuf[2] : [Input] Module ID, 0x87024
- dwBuf[3] : [Input] 0= Checksum disable; 1= Checksum enable
- dwBuf[4] : [Input] Timeout setting , normal=100 milliseconds
- dwBuf[5] : [Input] The defined analog output channel No.
- dwBuf[6] : [Input] 0 → no save to szSend & szReceive

1 → Save to szSend & szReceive

dwBuf[7] : [Input] Slot number
dwBuf[8] : [Output] Output range: 0x30, 0x31,0x32
dwBuf[9] : [Output] Slew rate
fBuf : Not used.
szSend : [Input] Command string to be sent to I-87000 series modules.
szReceive : [Output] Result string receiving from I-87000 series modules.

Return Value:

0: The function was successfully processed.

Other: The processing failed.

Refer to Chapter 6.7: “Error Code Definitions” for details of other returned values.

Examples:

```
float fBuf[12];  
char szSend[80];  
char szReceive[80];  
DWORD Status;  
DWORD Rate;  
DWORD dwBuf[12];  
DWORD m_port=3;  
DWORD m_address=1;  
DWORD m_timeout=100;  
DWORD m_checksum=0;  
Open_Com(COM3, 9600, Data8Bit, NonParity, OneStopBit);  
dwBuf[0] = m_port;  
dwBuf[1] = m_address;  
dwBuf[2] = 0x87024;  
dwBuf[3] = m_checksum;  
dwBuf[4] = m_timeout;  
dwBuf[5] = 1;  
dwBuf[6] = 1;  
dwBuf[7] = 1;  
ReadConfigurationStatus_87K (dwBuf, fBuf, szSend, szReceive);  
Status = dwBuf[8];  
Rate = dwBuf[9];  
Close_Com(COM3);
```

Remark:

■ SetStartUpValue_87K

Description:

This function is used to setting start-up value of analog output module for I-87000 series modules.

Syntax:

```
[ C ]  
WORD SetStartUpValue_87K(DWORD dwBuf[], float fBuf[],char szSend[],  
char szReceive[])
```

Parameter:

dwBuf: DWORD Input/Output argument talbe
dwBuf[0] : [Input] COM port number, from 1 to 255
dwBuf[1] : [Input] Module address, form 0x00 to 0xFF
dwBuf[2] : [Input] Module ID, 0x87024
dwBuf[3] : [Input] 0= Checksum disable; 1= Checksum enable
dwBuf[4] : [Input] Timeout setting , normal=100 milliseconds
dwBuf[5] : [Input] The defined analog output channel No.
dwBuf[6] : [Input] 0 → no save to szSend & szReceive
 1 → Save to szSend & szReceive
dwBuf[7] : [Input] Slot number
fBuf : Not used.
szSend : [Input] Command string to be sent to I-87000 series modules.
szReceive : [Output] Result string receiving from I-87000 series modules.

Return Value:

0: The function was successfully processed.

Other: The processing failed.

Refer to Chapter 6.7: "Error Code Definitions" for details of other returned values.

Examples:

```
float fBuf[12];  
char szSend[80];  
char szReceive[80];  
DWORD dwBuf[12];  
DWORD m_port=3;  
DWORD m_address=1;  
DWORD m_timeout=100;  
DWORD m_checksum=0;
```

```
Open_Com(COM3, 9600, Data8Bit, NonParity, OneStopBit);  
dwBuf[0] = m_port;  
dwBuf[1] = m_address;  
dwBuf[2] = 0x87024;  
dwBuf[3] = m_checksum;  
dwBuf[4] = m_timeout;  
dwBuf[5] = 1;  
dwBuf[6] = 1;  
dwBuf[7] = 1;  
SetStartUpValue_87K(dwBuf, fBuf, szSend, szReceive);  
Close_Com(COM3);
```

Remark:

■ ReadStartUpValue_87K

Description:

This function is used to setting start-up value of analog output module for I-87000 series modules.

Syntax:

```
[ C ]  
WORD SetStartUpValue_87K(DWORD dwBuf[], float fBuf[],char szSend[],  
char szReceive[])
```

Parameter:

dwBuf: DWORD Input/Output argument talbe
dwBuf[0] : [Input] COM port number, from 1 to 255
dwBuf[1] : [Input] Module address, form 0x00 to 0xFF
dwBuf[2] : [Input] Module ID, 0x87024
dwBuf[3] : [Input] 0= Checksum disable; 1= Checksum enable
dwBuf[4] : [Input] Timeout setting , normal=100 milliseconds
dwBuf[5] : [Input] The defined analog output channel No.
dwBuf[6] : [Input] 0 → no save to szSend & szReceive
 1 → Save to szSend & szReceive
dwBuf[7] : [Input] Slot number
fBuf : Float input/output argument table.
fBuf[0] : Start-Up value.
szSend : [Input] Command string to be sent to I-87000 series modules.
szReceive : [Output] Result string receiving from I-87000 series modules.

Return Value:

0: The function was successfully processed.

Other: The processing failed.

Refer to Chapter 6.7: "Error Code Definitions" for details of other returned values.

Examples:

```
Float StartUp;  
float fBuf[12];  
char szSend[80];  
char szReceive[80];  
DWORD dwBuf[12];  
DWORD m_port=3;  
DWORD m_address=1;
```

```
DWORD m_timeout=100;
DWORD m_checksum=0;
Open_Com(COM3, 9600, Data8Bit, NonParity, OneStopBit);
dwBuf[0] = m_port;
dwBuf[1] = m_address;
dwBuf[2] = 0x87024;
dwBuf[3] = m_checksum;
dwBuf[4] = m_timeout;
dwBuf[5] = 0;
dwBuf[6] = 1;
dwBuf[7] = 1;
ReadStartUpValue_87K(dwBuf, fBuf, szSend, szReceive);
StartUp = fBuf[0];
Close_Com(COM3);
```

Remark:

6.5 Error Code Explanation

Error Code	Explanation
0	NoError
1	FunctionError
2	PortError
3	BaudrateError
4	DataError
5	StopError
6	ParityError
7	ChecksumError
8	ComPortNotOpen
9	SendThreadCreateError
10	SendCmdError
11	ReadComStatusError
12	StrCheck Error
13	CmdError
14	X
15	TimeOut
16	X
17	ModuleId Error
18	AdChannelError
19	UnderRang
20	ExceedRange
21	InvalidateCounterValue
22	InvalidateCounterValue
23	InvalidateGateMode
24	InvalidateChannelNo
25	ComPortInUse

6.6 3-axis Encoder Functions

■ I8090_REGISTRATION

Description:

In order to distinguish more than one I-8090W card in the LP-8x21 platform, the I-8090W modules should be registered before using it. If there are no I-8090W modules in the LP-8x21 at the given address, this function will return 0 which means a failure.

Syntax:

```
[ C ]  
unsigned char I8090_REGISTRATION(unsigned char slot, unsigned int address)
```

Parameter:

slot : [Input] Specifies the slot where the I/O module is inserted. (Range: 1 to 8)
address : This parameter is not used in the LP-8x21.

Return Value:

1: Success registration
0: Failure registration

Examples:

```
unsigned char slot=1;  
unsigned int address=0x0;  
I8090_REGISTRATION(slot, address); // I-8090W is inserted in slot 1 of LinPAC.
```

Remark:

This function can be applied on module: I-8090W.

■ I8090_INIT_CARD

Description:

This function is applied to reset the I-8090W counter values of three axes in a specific slot of LinPAC and set the modes of three counters.

Syntax:

```
[ C ]  
void I8090_INIT_CARD(unsigned char cardNo, unsigned char x_mode,  
                    unsigned char y_mode, unsigned char z_mode)
```

Parameter:

cardNo : [Input] Specifies the slot where the I/O module is inserted. (Range: 1 to 8)
x_mode : [Input] The X axis counter mode. Refer to the Remarks.
y_mode : [Input] The Y axis counter mode. Refer to the Remarks.
z_mode : [Input] The Z axis counter mode. Refer to the Remarks.

Return Value:

None

Examples:

```
unsigned char slot=1;  
unsigned int address=0x0;  
I8090_REGISTRATION(slot, address);  
I8090_INIT_CARD(slot, ENC_QUADRANT, ENC_QUADRANT,  
                ENC_QUADRANT);  
  
//The X, Y, Z axis encoder mode are ENC_QUADRANT mode.
```

Remark:

There are three modes for each axis of I-8090W :

- (1) ENC_QUADRANT
- (2) ENC_CW_CCW
- (3) ENC_PULSE_DIR

■ I8090_GET_ENCODER

Description:

This function is used to obtain the counter value of the selected axis on the specified encoder card. This counter value is defined in the short (16-bit) format.

Syntax:

```
[ C ]  
unsigned int I8090_GET_ENCODER(unsigned char cardNo, unsigned char axis)
```

Parameter:

cardNo : [Input] Specifies the slot where the I/O module is inserted. (Range: 1 to 8)
axis : [Input] The selected axis. 1: X_axis; 2: Y_axis; 3: Z_axis

Return Value:

A 16 bits unsigned integer value.

Examples:

```
unsigned char slot=1;  
unsigned int address=0x0;  
unsigned int data;  
I8090_REGISTRATION(slot, address);  
I8090_INIT_CARD(slot, ENC_QUADRANT, ENC_QUADRANT,  
                ENC_QUADRANT);  
data= I8090_GET_ENCODER(slot, X_axis);  
//The data value is the X-axis encoder value.
```

Remark:

This function can be applied on module: I-8090W.

■ I8090_RESET_ENCODER

Description:

This function is used to reset the counter value to be zero for the selected axis on the specified encoder card.

Syntax:

```
[ C ]  
void I8090_RESET_ENCODER(unsigned char cardNo, unsigned char axis)
```

Parameter:

cardNo : [Input] Specifies the slot where the I/O module is inserted. (Range: 1 to 8)
axis : [Input] The selected axis. 1: X_axis; 2: Y_axis; 3: Z_axis

Return Value:

None

Examples:

```
unsigned char slot=1;  
unsigned int address=0x0;  
I8090_REGISTRATION(slot, address);  
I8090_INIT_CARD(slot, ENC_QUADRANT, ENC_QUADRANT,  
                ENC_QUADRANT);  
I8090_RESET_ENCODER(slot, X_axis); //Set X-axis counter value to be zero.
```

Remark:

This function can be applied on module: I-8090W.

■ I8090_GET_ENCODER32

Description:

This function is used to obtain the counter value of the selected axis on the specified encoder card. The counter value is defined in the long (32-bit) format. Users must call I8090_ENCODER32_ISR() function before using this function.

Syntax:

```
[ C ]  
long I8090_GET_ENCODER32(unsigned char cardNo,unsigned char axis)
```

Parameter:

cardNo : [Input] Specifies the slot where the I/O module is inserted. (Range: 1 to 8).
axis : [Input] The selected axis. 1: X_axis; 2: Y_axis; 3: Z_axis

Return Value:

A 32 bits integer value.

Examples:

```
unsigned char slot=1;  
unsigned int address=0x0;  
long data;  
I8090_REGISTRATION(slot, address);  
I8090_INIT_CARD(slot, ENC_QUADRANT, ENC_QUADRANT,  
                ENC_QUADRANT);  
I8090_ENCODER32_ISR(slot);  
data=I8090_GET_ENCODER32(slot, X_axis);  
// The data value is the X-axis encoder value.
```

Remark:

This function can be applied on module: I-8090W.

■ I8090_RESET_ENCODER32

Description:

This function is applied to reset the counter variable of the function I8090_Get_Encoder32.

Syntax:

```
[ C ]  
void I8090_RESET_ENCODER32(unsigned char cardNo, unsigned char axis)
```

Parameter:

cardNo : [Input] Specifies the slot where the I/O module is inserted. (Range: 1 to 8)
axis : [Input] The selected axis. 1: X_axis; 2: Y_axis; 3: Z_axis

Return Value:

None

Examples:

```
unsigned char slot=1;  
unsigned int address=0x0;  
I8090_REGISTRATION(slot, address);  
I8090_INIT_CARD(slot, ENC_QUADRANT, ENC_QUADRANT,  
                ENC_QUADRANT);  
I8090_RESET_ENCODER(slot, X_axis); // X-axis encoder value set zero.
```

Remark:

This function can be applied on module: I-8090W.

■ I8090_GET_INDEX

Description:

This function is used to get the value of the “INDEX” register on the specified card.

Syntax:

```
[ C ]  
unsigned char I8090_GET_INDEX(unsigned char cardNo)
```

Parameter:

cardNo : [Input] Specifies the slot where the I/O module is inserted. (Range: 1 to 8).

Return Value:

Register	Add.	R/W	Bit 7	Bit 6	Bit 5	Bit 4	Bit 3	Bit 2	Bit 1	Bit 0
INDEX	0x08	R						ZI	YI	XI

Examples:

```
unsigned char slot, data;  
data=I8090_GET_INDEX(slot); //Returned value: data=0x07
```

Remark:

This function can be applied on module: I-8090W. The index input C+/C- can be read out from this register. These bits are highly active.

XI : Indicate the index of X-axis.

YI : Indicate the index of Y-axis.

ZI : Indicate the index of Z-axis.

■ I8090_ENCODER32_ISR

Description:

This function is used to calculate the pulse value between present and last time with a "long" type format. Therefore, I8090_ENCODER32_ISR() function should be executed periodically (2 to 10ms) using the timer interrupt or manual method.

Syntax:

```
[ C ]  
void I8090_ENCODER32_ISR(unsigned char cardNo)
```

Parameter:

cardNo : [Input] Specifies the slot where the I/O module is inserted. (Range: 1 to 8).

Return Value:

None

Examples:

```
unsigned char slot;  
long data;  
i8090_ENCODER32_ISR(slot); // should be called in 2 to 20ms.  
data=i8090_GET_ENCODER32(slot, X_axis);
```

Remark:

This function can be applied on module: I-8090W.

6.7 2-axis Stepper/Servo Functions

■ I8091_REGISTRATION

Description:

This function is used to assign a card number “cardNo” to the I-8091W card in the specified slot. In order to distinguish more than one of the I-8091 cards in the LP-8x21 platform, the I-8091W cards should be registered before using them. If there are no I-8091W modules at the given address, this command will return 0 which is a failure value.

Syntax:

```
[ C ]  
unsigned char I8091_REGISTRATION(unsigned char cardNo, int slot)
```

Parameter:

cardNO : [Input] The board number (0 to 19)

slot : [Input] Specifies the slot where the I/O module is inserted. (1 to 7)

Return Value:

1: card exist

0: card not exist

Examples:

```
#define CARD1 1  
int slot=1;  
i8091_REGISTRATION(CARD1, slot);  
// The I-8091W card is inserted in slot 1 of LP-8x21.
```

Remark:

This function can be applied on module: I-8091W.

■ i8091_RESET_SYSTEM

Description:

This function is used to reset and terminate the running command in the I-8091W module. Users can apply this command in software emergencies as a stop function. It can also clear all the card settings. After calling this function, users need to configure all the parameters in the I-8091W card.

Syntax:

```
[ C ]  
void i8091_RESET_SYSTEM(unsigned char cardNo)
```

Parameter:

cardNO : [Input] 0 to 19, The selected card number.

Return Value:

None

Examples:

```
#define CARD1 1  
int slot=1;  
i8091_REGISTRATION(CARD1, slot);  
i8091_RESET_SYSTEM(CARD1);  
// The I-8091W card inserted in slot 1 of LP-8x21
```

Remark:

This function can be applied on module: I-8091W.

■ i8091_SET_VAR

Description:

This function is used to set the DDA cycle, plus accelerating/decelerating speeds, low-speed and the high-speed values in the specified I-8091 card.

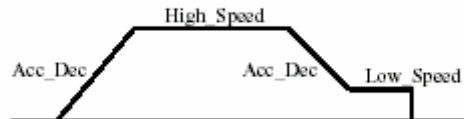

Syntax:

[C]

```
void i8091_SET_VAR(unsigned char cardNo, unsigned char DDA_cycle,  
                  unsigned char Acc_Dec, unsigned int Low_Speed, unsigned int High_Speed)
```

Parameter:

cardNO : [Input] 0 to 19, The selected card number.

DDA_cycle : [Input] 1<=DDA_cycle<=254.

Acc_Dec : [Input] 1<=Acc_Dec<=200.

Low_Speed : [Input] 1<=Low_Speed<=200.

High_Speed : [Input] Low_Speed<=High_Speed<=2047.

Return Value:

None

Examples:

```
#define CARD1 1  
int slot=1;  
i8091_REGISTRATION(CARD1, slot);  
i8091_SET_VAR(CARD1, 5, 2, 10, 150);
```

Remark:

This function can be applied on module: I-8091W.

■ i8091_SET_DEFDIR

Description:

This function is used to define the rotating directions of the X and Y axes on the controlling motors. Sometimes, the output direction of the X-axis or Y-axis is in an undesired direction because of the wire connection to the motor or gear train mechanism. In order to unify the output direction, the CW/FW directions of the X/Y axis are defined as an outside going motion through the motor control, and similarly the CCW/BW directions are defined as the inward motion through the motor control.

Syntax:

```
[C]  
void i8091_SET_DEFDIR(unsigned char cardNo, unsigned char defdirX,  
                    unsigned char defdirY)
```

Parameter:

cardNO : [Input] The board number (0 to 19)
defdirX : [Input] X axis direction definition
 (0:NORMAL_DIR, 1:REVERSE_DIR)
defdirY : [Input] Y axis direction definition
 (0:NORMAL_DIR, 1:REVERSE_DIR)

Return Value:

None

Examples:

```
#define CARD1 1  
int slot=1;  
i8091_REGISTRATION(CARD1, slot);  
i8091_SET_DEFDIR(CARD1, NORMAL_DIR, NORMAL_DIR);
```

Remark:

This function can be applied on module: I-8091W.

■ i8091_SET_MODE

Description:

This function is used to set the motor control modes of the X and Y axes in the specified I-8091W.

Syntax:

```
[ C ]  
void i8091_SET_MODE(unsigned char cardNo, unsigned char modeX,  
                    unsigned char modeY)
```

Parameter:

- cardNO : [Input] The board number (0 to 19)
- modeX : [Input] X axis output mode
(0: CW/CCW mode, 1: Pulse/Direction mode)
- modeY : [Input] Y axis output mode
(0: CW/CCW mode, 1: Pulse/Direction mode)

Return Value:

None

Examples:

```
#define CARD1 1  
int slot=1;  
i8091_REGISTRATION(CARD1, slot);  
i8091_SET_MODE(CARD1, CW_CCW, CW_CCW);
```

Remark:

This function can be applied on module: I-8091W.

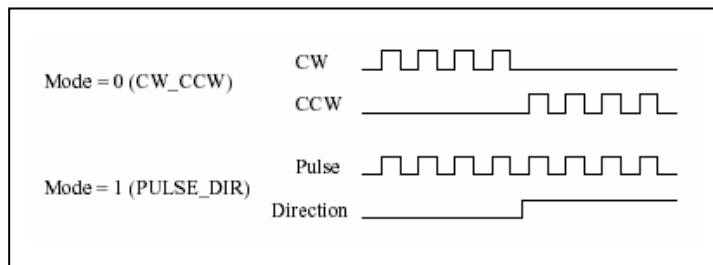

■ i8091_SET_SERVO_ON

Description:

This function is used to turn the servo function on/off to get the motor driver ready or to stop motor control.

Syntax:

```
[ C ]  
void i8091_SET_SERVO_ON(unsigned char cardNo, unsigned char sonX,  
                        unsigned char sonY)
```

Parameter:

cardNO : [Input] The board number (0 to 19)
modeX : [Input] X-axis servo/hold on switch (1:ON , 0:OFF)
modeY : [Input] X-axis servo/hold on switch (1:ON , 0:OFF)

Return Value:

None

Examples:

```
#define CARD1 1  
int slot=1;  
i8091_REGISTRATION(CARD1, slot);  
i8091_SET_SERVO_ON(CARD1, ON, ON);
```

Remark:

This function can be applied on module: I-8091W.

■ i8091_SET_NC

Description:

This function is used to set all of the following limit switches to N.C.(normally closed) or N.O.(normally open). If users set the “sw” parameter as N.O, then those limit switches are active low. If users set the value as N.C, those limit switches are then “active high”. The auto-protection system will automatically change the judgments, whatever it is, to N.O. or N.C.

Limit switches: ORG1, LS11, LS14, ORG2, LS21, LS24, EMG.

Syntax:

```
[ C ]  
void i8091_SET_NC(unsigned char cardNo, unsigned char sw)
```

Parameter:

cardNO : [Input] The board number (0 to 19)

sw : [Input] 0(NO) normally open (default), 1(YES) normally closed.

Return Value:

None

Examples:

```
#define CARD1 1  
int slot=1;  
i8091_REGISTRATION(CARD1, slot);  
i8091_SET_NC(CARD1, NO, NO);
```

Remark:

This function can be applied on module: I-8091W.

■ i8091_STOP_X

Description:

This function is used to stop the X-axis from running immediately.

Syntax:

```
[ C ]  
void i8091_STOP_X(unsigned char cardNo)
```

Parameter:

cardNO : [Input] The board number (0 to 19)

Return Value:

None

Examples:

```
#define CARD1 1  
int slot=1;  
i8091_REGISTRATION(CARD1, slot);  
i8091_STOP_X(CARD1);  
// The X-axis is stopped.
```

Remark:

This function can be applied on module: I-8091W.

This command would stop the X axis immediately.

■ i8091_STOP_Y

Description:

This function is used to stop the Y-axis from running immediately.

Syntax:

```
[ C ]  
void i8091_STOP_Y(unsigned char cardNo)
```

Parameter:

cardNO : [Input] The board number (0 to 19)

Return Value:

None

Examples:

```
#define CARD1 1  
int slot=1;  
i8091_REGISTRATION(CARD1, slot);  
i8091_STOP_Y(CARD1);  
// The Y-axis is stopped.
```

Remark:

This function can be applied on module: I-8091W.

This command would stop the Y axis immediately.

■ i8091_STOP_ALL

Description:

This function is used to stop both the X and Y axis immediately. It will clear all commands that are pending in the FIFO.

Syntax:

```
[ C ]  
void i8091_STOP_ALL(unsigned char cardNo)
```

Parameter:

cardNO : [Input] The board number (0 to 19)

Return Value:

None

Examples:

```
#define CARD1 1  
int slot=1;  
i8091_REGISTRATION(CARD1, slot);  
i8091_STOP_ALL(CARD1);  
//The X-axis and Y-axis are stopped.
```

Remark:

This function can be applied on module: I-8091W.

■ i8091_EMG_STOP

Description:

This function is the same as the i8091_STOP_ALL function, but can only be used in the interrupt routine. It can clear all the commands that are pending in the FIFO.

Syntax:

```
[ C ]  
void i8091_EMG_STOP(unsigned char cardNo)
```

Parameter:

cardNO : [Input] The board number (0 to 19)

Return Value:

None

Examples:

```
#define CARD1 1  
int slot=1;  
i8091_REGISTRATION(CARD1, slot);  
i8091_EMG_STOP(CARD1);  
//The X-axis and Y-axis are stopped.
```

Remark:

This function can be applied on module: I-8091W.

■ i8091_LSP_ORG

Description:

This function is used to stop specific (X/Y) axis in low-speed movement when the ORG1/ORG2 limit switch is in contact.

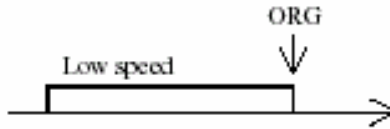

Syntax:

```
[ C ]  
void i8091_LSP_ORG(unsigned char cardNo, unsigned char DIR,  
                  unsigned char AXIS)
```

Parameter:

cardNO : [Input] The board number (0 to 19)
DIR : [Input] The moving direction. (0: CW, 1: CCW)
AXIS : [Input] The selected axis. (1: X_axis, 2: Y_axis)

Return Value:

None

Examples:

```
#define CARD1 1  
int slot=1;  
i8091_REGISTRATION(CARD1, slot);  
i8091_LSP_ORG(CARD1, CCW, X_axis);  
i8091_LSP_ORG(CARD1, CCW, Y_axis);
```

Remark:

This function can be applied on module: I-8091W.

■ i8091_HSP_ORG

Description:

This function drives the specified (X/Y) axis to search for their home position (ORG1/ORG2) in the high-speed mode motion and stops the motion when the ORG1/ORG2 limit switch is pushed.

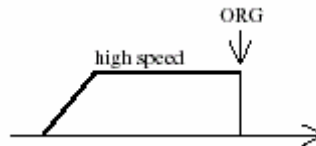

Syntax:

```
[ C ]  
void i8091_HSP_ORG(unsigned char cardNo, unsigned char DIR,  
                  unsigned char AXIS)
```

Parameter:

cardNO : [Input] The board number (0 to 19)
DIR : [Input] The moving direction. (0: CW, 1: CCW)
AXIS : [Input] The selected axis. (1: X_axis, 2: Y_axis)

Return Value:

None

Examples:

```
#define CARD1 1  
int slot=1;  
i8091_REGISTRATION(CARD1, slot);  
i8091_HSP_ORG(CARD1, CCW, X_axis);  
i8091_HSP_ORG(CARD1, CCW, Y_axis);
```

Remark:

This function can be applied on module: I-8091W.

■ i8091_LSP_PULSE_MOVE

Description:

This function drives the specified axis into motion toward the desired position from the given pulse number in low-speed mode.

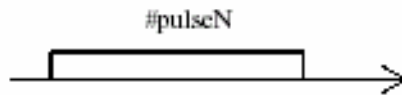

Syntax:

```
[ C ]  
void i8091_LSP_PULSE_MOVE(unsigned char cardNo, unsigned char AXIS,  
                           long pulseN)
```

Parameter:

cardNO : [Input] The board number (0 to 19)
AXIS : [Input] The selected axis (1: X_axis, 2: Y_axis)
pulseN : [Input] The moving number of pulse.

Return Value:

None

Examples:

```
i8091_LSP_PULSE_MOVE(CARD1, X_axis, 20000);  
i8091_LSP_PULSE_MOVE(CARD1, X_axis, -2000);  
i8091_LSP_PULSE_MOVE(CARD1, Y_axis, 20000);  
i8091_LSP_PULSE_MOVE(CARD1, Y_axis, -2000);  
// when pulseN>0, move toward CW/FW direction  
// when pulseN<0, move toward CCW/BW direction
```

Remark:

This function can be applied on module: I-8091W.

■ i8091_HSP_PULSE_MOVE

Description:

This function drives the specified axis into motion toward the desired position from the given pulse number in high-speed mode.

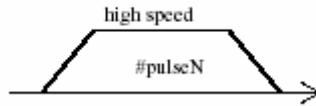

Syntax:

```
[C]  
void i8091_HSP_PULSE_MOVE(unsigned char cardNo, unsigned char AXIS,  
                           long pulseN)
```

Parameter:

- cardNO : [Input] The board number (0 to 19)
- AXIS : [Input] The selected axis (1: X_axis, 2: Y_axis)
- pulseN : [Input] The moving number of pulse.

Return Value:

None

Example:

```
i8091_HSP_PULSE_MOVE(CARD1, X_axis, 20000);  
i8091_HSP_PULSE_MOVE(CARD1, X_axis, -2000);  
i8091_HSP_PULSE_MOVE(CARD1, Y_axis, 20000);  
i8091_HSP_PULSE_MOVE(CARD1, Y_axis, -2000);  
// when pulseN>0, move toward CW/FW direction  
// when pulseN<0, move toward CCW/BW direction
```

Remark:

This function can be applied on module: I-8091W.

■ i8091_LSP_MOVE

Description:

This function drives the specified axis into motion toward the selected direction in low-speed mode. It can be stopped by the i8091_STOP_X function, or the i8091_STOP_Y function, or the i8091_STOP_ALL function.

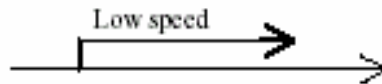

Syntax:

```
[ C ]  
void i8091_LSP_MOVE(unsigned char cardNo, unsigned char DIR, unsigned char AXIS)
```

Parameter:

cardNO : [Input] The board number (0 to 19)
DIR : [Input] The moving direction. (0: CW, 1: CCW)
AXIS : [Input] The selected axis (1: X_axis, 2: Y_axis)

Return Values:

None

Example:

```
i8091_LSP_MOVE(CARD1, CW, X_axis);  
i8091_LSP_MOVE(CARD1, CW, Y_axis);
```

Remark:

This function can be applied on module: I-8091W.

■ i8091_HSP_MOVE

Description:

This function drives the specified axis into motion toward the selected direction in high-speed mode. It can be stopped by the i8091_STOP_X, or i8091_STOP_Y, or i8091_STOP_ALL functions.

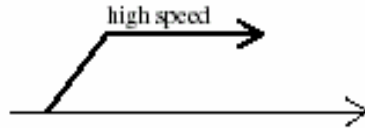

Syntax:

```
[ C ]  
void i8091_HSP_MOVE(unsigned char cardNo, unsigned char DIR, unsigned char AXIS)
```

Parameter:

cardNO : [Input] The board number (0 to 19)
DIR : [Input] The moving direction. (0: CW, 1: CCW)
AXIS : [Input] The selected axis (1: X_axis, 2: Y_axis)

Return Value:

None

Examples:

```
i8091_HSP_MOVE(CARD1, CW, X_axis);  
i8091_HSP_MOVE(CARD1, CW, Y_axis);
```

Remark:

This function can be applied on module: I-8091W.

■ i8091_CSP_MOVE

Description:

This function is used to accelerate/decelerate the motor on the selected axis into motion up/down to the desired speed. If commands are continuously applied to the I-8091, then this function can dynamically change the motor speed. The rotating motor can be stopped by using the following commands: `i8091_STOP_X()`, `i8091_STOP_Y()`, `i8091_STOP_ALL()`, or `i8091_SLOW_STOP()`.

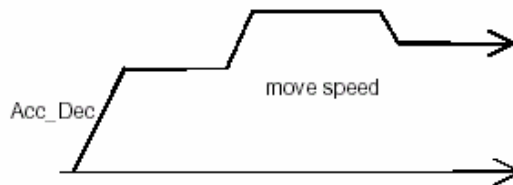

Syntax:

```
[C]
void i8091_CSP_MOVE(unsigned char cardNo, unsigned char dir,
                    unsigned char axis, unsigned int move_speed)
```

Parameter:

cardNO : [Input] The board number (0 to 19)
dir : [Input] The moving direction. (0: CW, 1: CCW)
axis : [Input] The selected axis. (1: X_axis, 2: Y_axis)
move_speed : [Input] $0 < \text{move_speed} \leq 2040$

Return Value:

None

Examples:

```
i8091_CSP_MOVE(CARD1, CW, X_axis, 10); //Delay(10000);
i8091_CSP_MOVE(CARD1, CW, X_axis, 20);
```

Remark:

This function can be applied on module: I-8091W.

■ i8091_SLOW_DOWN

Description:

This function is used to decelerate the motor motion to a specific low speed in order to be able to call either the i8091_STOP_X(), or i8091_STOP_Y(), or i8091_STOP_ALL functions so that the motor's motion can be stopped.

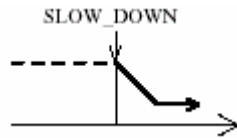

Syntax:

[C]

```
void i8091_SLOW_DOWN(unsigned char cardNo, unsigned char AXIS)
```

Parameter:

cardNO : [Input] The board number (0 to 19)

AXIS : [Input] The selected axis (1: X_axis, 2: Y_axis)

Return Value:

None

Examples:

```
i8091_HSP_MOVE(CARD1, CW, X_axis);
```

```
i8091_SLOW_DOWN(CARD1, X_axis);
```

```
i8091_STOP_X(CARD1);
```

Remark:

This function can be applied on module: I-8091W.

■ i8091_SLOW_STOP

Description:

This function is used to decelerate the speed of a specified axis and then stop it (as shown in following figure).

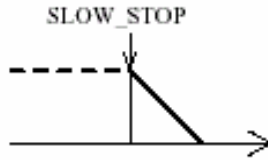

Syntax:

[C]

```
void i8091_SLOW_STOP(unsigned char cardNo, unsigned char AXIS)
```

Parameter:

cardNO : [Input] The board number (0 to 19)

AXIS : [Input] The selected axis (1: X_axis, 2: Y_axis)

Return Value:

None

Examples:

```
i8091_HSP_MOVE(CARD1, CW, Y_axis);
```

```
i8091_SLOW_STOP(CARD1, Y_axis);
```

Remark:

This function can be applied on module: I-8091W.

■ i8091_INTP_PULSE

Description:

This function is used to move a short distance (interpolation short line) in the X-Y plane. This command provides a method for users to generate an arbitrary curve in a X-Y plane.

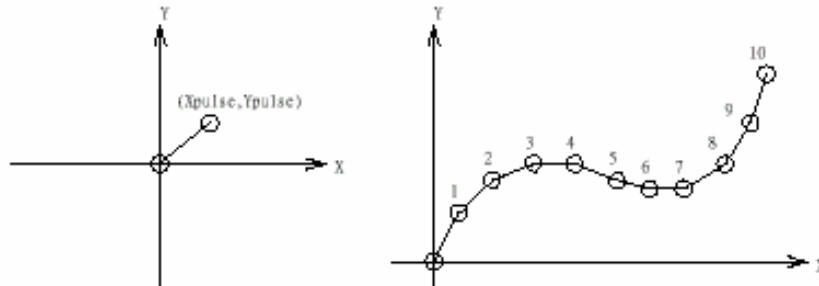

Syntax:

[C]

```
void i8091_INTP_PULSE(unsigned char cardNo, int Xpulse, int Ypulse)
```

Parameter:

cardNO : [Input] The board number (0 to 19)
Xpulse : [Input] - 2047<= # Xpulse <=2047
Ypulse : [Input] - 2047<= # Ypulse <=2047

Return Value:

None

Examples:

```
i8091_INTP_PULSE(CARD1, 20, 20);  
i8091_INTP_PULSE(CARD1, 20, 13);  
i8091_INTP_PULSE(CARD1, 20, 7);  
i8091_INTP_PULSE(CARD1, 20, 0);  
i8091_INTP_PULSE(CARD1,15, -5);
```

Remark:

This function can be applied on module: I-8091W.

■ i8091_INTP_LINE

Description:

This command will move a long distance (interpolation line) in the X-Y plane. The CPU on the I-8091W will generate a trapezoidal speed profile of the X-axis and Y-axis, and then execute interpolation by way of a DDA chip.

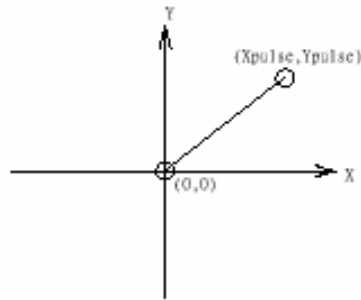

Syntax:

[C]

```
void i8091_INTP_LINE(unsigned char cardNo, int Xpulse, int Ypulse)
```

Parameter:

cardNO : [Input] The board number (0 to 19)
Xpulse : [Input] - 524287 <= # Xpulse <= 524287
Ypulse : [Input] - 524287 <= # Ypulse <= 524287

Return Value:

None

Examples:

```
i8091_INTP_LINE(CARD1, 2000, -3000);  
i8091_INTP_LINE(CARD1, -500, 200);
```

Remark:

This function can be applied on module: I-8091W.

■ i8091_INTP_LINE02

Description:

This function is used to move a long interpolation line in the X-Y plane. The host will automatically generate a trapezoidal speed profile of the X-axis and Y-axis via the state-machine-type calculation method. The i8091_INTP_LINE02 function only sets parameters into the driver. Users can directly utilize the do { } while (i8091_INTP_STOP() !=READY) method to apply the computing entity.

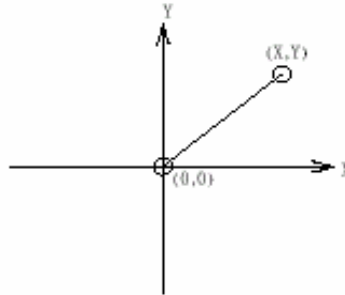

Syntax:

[C]

```
void i8091_INTP_LINE02(unsigned char cardNo, long x, long y,  
                        unsigned int speed, unsigned char acc_mode)
```

Parameter:

cardNO : [Input] The board number (0 to 19)
x : [Input] The end point of the line relates to the present position
y : [Input] The end point of the line relates to the present position
speed : [Input] 0 to 2040
acc_mode : [Input] 0: enables the acceleration and deceleration profiles
 1: disables the acceleration and deceleration profiles

Return Value:

None

Examples:

```
i8091_INTP_LINE02(CARD1, 1000, 1000, 100, 0);  
do { } while(i8091_INTP_STOP() !=READY); //call state machine
```

Remark:

This function can be applied on module: I-8091W.

■ i8091_INTP_CIRCLE02

Description:

This function is used to generate an interpolation circle in the X-Y plane. The host will automatically generate a trapezoidal speed profile of the X-axis and Y-axis via the state-machine-type calculation method. The i8091_INTP_CIRCLE02 function only sets parameters into the driver. Users can directly utilize the do { } while (i8091_INTP_STOP() !=READY) method to execute the computing entity.

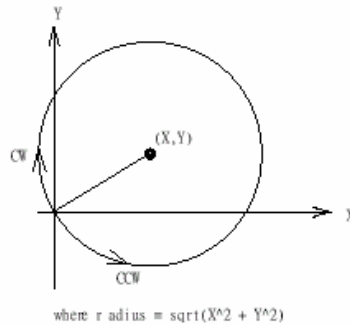

Syntax:

[C]

```
void i8091_INTP_CIRCLE02(unsigned char cardNo, long x, long y,  
                          unsigned chat dir, unsigned int speed, unsigned char acc_mode)
```

Parameter:

cardNO : [Input] The board number (0 to 19)
x : [Input] The center point of the circle relates to the present position
y : [Input] The center point of the circle relates to the present position
dir : [Input] The moving direction. (0: CW, 1: CCW)
speed : [Input] 0 to 2040
acc_mode : [Input] 0: enable acceleration and deceleration profile
 1: disable acceleration and deceleration profile

Return Value:

None

Examples:

```
i8091_INTP_CIRCLE02(CARD1, 2000, 2000, 100, 0);  
do { } while(i8091_INTP_STOP() !=READY); //call state machine
```

Remark:

This function can be applied on module: I-8091W.

■ i8091_INTP_ARC02

Description:

This command generates an interpolation arc in the X-Y plane. The host will automatically generate a trapezoidal speed profile of the X-axis and Y-axis via the state-machine-type calculation method. The i8091_INTP_ARC02() only sets parameters into the driver. Users can directly call the do { } while (i8091_INTP_STOP() !=READY) method to execute the computing entity.

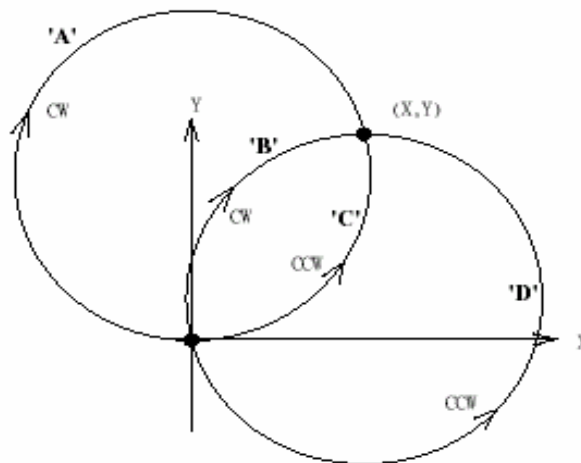

Syntax:

[C]

```
void i8091_INTP_ARC02(unsigned char cardNo, long x, long y, long R,
    unsigned char dir, unsigned int speed, unsigned char acc_mode)
```

Parameter:

- cardNO : [Input] The board number (0 to 19)
- x : [Input] The center point of the circle relates to the present position
- y : [Input] The center point of the circle relates to the present position
- R : [Input] The radius of arc
- dir : [Input] The moving direction (0: CW, 1: CCW)

R	dir	path of curve
R>0	CW	'B'
R>0	CCW	'C'
R<0	CW	'A'
R<0	CCW	'D'

- speed : [Input] 0 to 2040
- acc_mode : [Input] 0: enables the acceleration and deceleration profiles
1: disables the acceleration and deceleration profiles

Return Value:

None

Examples:

```
i8091_INTP_ARC02(CARD1, 2000, -2000, 2000, CW, 100, 0);  
do { } while(i8091_INTP_STOP()!=READY) ; //call state machine
```

Remark:

This function can be applied on module: I-8091W.

Restriction:

$$-2^{32} + 1 \leq x \leq 2^{32} - 1$$

$$-2^{32} + 1 \leq y \leq 2^{32} - 1$$

$$-2^{32} + 1 \leq R \leq 2^{32} - 1$$

$$R \geq \frac{\sqrt{x^2 + y^2}}{2}$$

■ i8091_INTP_STOP

Description:

This function must be applied when stopping the motor motion control for the above described 3 state-machine-type interpolation functions, to be precise the i8091_INTP_LINE02, i8091_INTP_CIRCLE02 and i8091_INTP_ARC02 functions. The state-machine-type interpolation functions only set parameters into the driver. The computing entity is in the i8091_INTP_STOP function. This function computes the interpolation profile. It will return READY(0) for when the interpolation command is completed, and return BUSY(1) for when it is not yet completed.

Syntax:

```
[ C ]  
unsigned char i8091_INTP_STOP(void)
```

Parameter:

None

Return Value:

0: READY

1: BUSY

Examples:

```
i8091_INTP_CIRCLE02(CARD1,2000,2000,100,0);  
do { } while(i8091_INTP_STOP()!=READY) ; //call state machine
```

Remark:

This function can be applied on module: I-8091W

■ i8091_LIMIT_X

Description:

This function is used to request the condition of the X-axis limit switches.

Syntax:

```
[ C ]  
unsigned char i8091_LIMIT_X(unsigned char cardNo)
```

Parameter:

cardNO : [Input] The board number (0 to 19)

Return Value:

a unsigned char value

MSB 7	6	5	4	3	2	1	0
/EMG	/FFFF	/FFEF	/LS14	xx	xx	/LS11	/ORG1

/ORG1 : original point switch of X-axis, low active.

/LS11, /LS14 : limit switches of X-axis, low active.

/EMG : emergency switch, low active.

/FFEF : active low, FIFO is empty

/FFFF : active low, FIFO is full

Examples:

```
unsigned char limit1;  
limit1 = i8091_LIMIT_X(CARD1);
```

Remark:

This function can be applied on module: I-8091W.

I-8091W User's Manual:

http://www.icpdas.com/root/product/solutions/machine_automation/download%20data/i8091/pack9091.pdf

■ i8091_LIMIT_Y

Description:

This function is used to request the condition of the Y-axis limit switches.

Syntax:

```
[ C ]  
unsigned char i8091_LIMIT_Y(unsigned char cardNo)
```

Parameter:

cardNO : [Input] The board number (0 to 19)

Return Value:

a unsigned char value

MSB 7	6	5	4	3	2	1	0
Ystop	Xstop	xx	/LS24	xx	xx	/LS21	/ORG2

/ORG2: original point switch of Y-axis, low active.

/LS21, /LS24: limit switches of Y-axis, low active.

Xstop: 1:indicate X-axis is stop.

Ystop: 1:indicate Y-axis is stop.

Examples:

```
unsigned char limit2;  
limit2 = i8091_LIMIT_Y(CARD1);
```

Remark:

This function can be applied on module: I-8091W.

I-8091W User's Manual:

http://www.icpdas.com/root/product/solutions/machine_automation/download%20data/i8091/pack9091.pdf

■ i8091_WAIT_X

Description:

This function is used to make the X-axis wait before going to the STOP state.

Syntax:

```
[ C ]  
void i8091_WAIT_X(unsigned char cardNo)
```

Parameter:

cardNO : [Input] The board number (0 to 19)

Return Value:

None

Example:

Remark:

This function can be applied on module: I8091W.

■ i8091_WAIT_Y

Description:

This function is used to make the Y-axis wait before going to the STOP state.

Syntax:

```
[ C ]  
void i8091_WAIT_Y(unsigned char cardNo)
```

Parameter:

cardNO : [Input] The board number (0 to 19)

Return Value:

None

Example:

Remark:

This function can be applied on module: I-8091W.

■ i8091_IS_X_STOP

Description:

This function is used to check whether the X-axis is in the stop state or not.

Syntax:

```
[ C ]  
unsigned char i8091_IS_X_STOP(unsigned char cardNo)
```

Parameter:

cardNO : [Input] The board number (0 to 19)

Return Value:

0 (NO) : not yet stop

1 (YES) : stop

Examples:

```
unsigned char data;  
data= i8091_IS_X_STOP(CARD1);
```

Remark:

This function can be applied on module: I-8091W.

■ i8091_IS_Y_STOP

Description:

This function is used to check whether the Y-axis is in the stop state or not.

Syntax:

```
[ C ]  
unsigned char i8091_IS_Y_STOP(unsigned char cardNo)
```

Parameter:

cardNO : [Input] The board number (0 to 19)

Return Value:

0 (NO) : not yet stop

1 (YES) : stop

Examples:

```
unsigned char data;  
data= i8091_IS_Y_STOP(CARD1);
```

Remark:

This function can be applied on module: I-8091W.

7. Demos for LP-8x21 Modules With C Language

In this section, we will focus on examples for the description and application of the control functions on the I-7000/I-8000/I-87k series modules for use with the LP-8x21. After installing the LP-8x21 SDK, the demo programs provided below can be found in the “c:/cygwin/LinCon8k/examples” folder.

7.1 DIO Control Demo for I-7k Modules

The **i7kdio.c** demo application illustrates how to control DI/DO function using an I-7050 module (8 DO channels and 7 DI channels) connected to an RS-485 network. The address of the module is 02 and the Baud Rate is 9600 bps.

The result of executing this demo program is that DO channels 0 to 7 on the I-7050 module will be set as the output channels, and DI channel 2 on the I-7050 module will be set as the input channel. The source code for the demo program is as follows:

```
#include<stdio.h>
#include<stdlib.h>
#include "msw.h"

char szSend[80], szReceive[80], ans;
WORD wBuf[12];
float fBuf[12];
/* ----- */
int main()
{
    int wRetVal;
    // Check Open_Com3
    wRetVal = Open_Com(COM3, 9600, Data8Bit, NonParity, OneStopBit);
    if (wRetVal > 0) {
        printf("open port failed!\n");
        return (-1);
    }
    // ***** 7050 DO && DI Parameter *****
    wBuf[0] = 3;           // COM Port
    wBuf[1] = 0x02;       // Address
    wBuf[2] = 0x7050;     // ID
    wBuf[3] = 0;          // CheckSum disabled
    wBuf[4] = 100;        // TimeOut , 100 milliseconds
```

```

wBuf[5] = 0x0f;           // Set 8 DO Channels to ON
wBuf[6] = 0;             // Debug string
// 7050 DO Output
wRetVal = DigitalOut(wBuf, fBuf, szSend, szReceive);
if (wRetVal)
    printf("DigitalOut_7050 Error !, Error Code=%d\n", wRetVal);

printf("The DO of 7050 : %u \n", wBuf[5]);

// 7050 DI Input
DigitalIn(wBuf, fBuf, szSend, szReceive);
printf("The DI of 7050 : %u \n", wBuf[5]);

Close_Com(COM3);
return 0;
}

```

Follow the procedure below to achieve the desired results:

STEP 1: Write i7kdio.c

Copy the above source code above to a blank text file and save it using the name - i7kdio.c or open the file from the C:\cygwin\LinCon8k\examples\i7k folder.

STEP 2: Compile i7kdio.c to an executable file - i7kdio.exe

Two methods can be used to compile the program, each of which is introduced here:

Method One – Using a Batch File (lcc.bat)

Open the LP-8x21 Build Environment by clicking the Start > Programs > ICPDAS > LP-8x21 SDK > LP-8x21 Build Environment to open **LP-8x21 SDK** window, and change the path to C:\cygwin\LinCon8k\examples\i7k. To compile the i7kdio.c file to an executable file, type **lcc i7kdio**. (refer to Fig. 7-1)

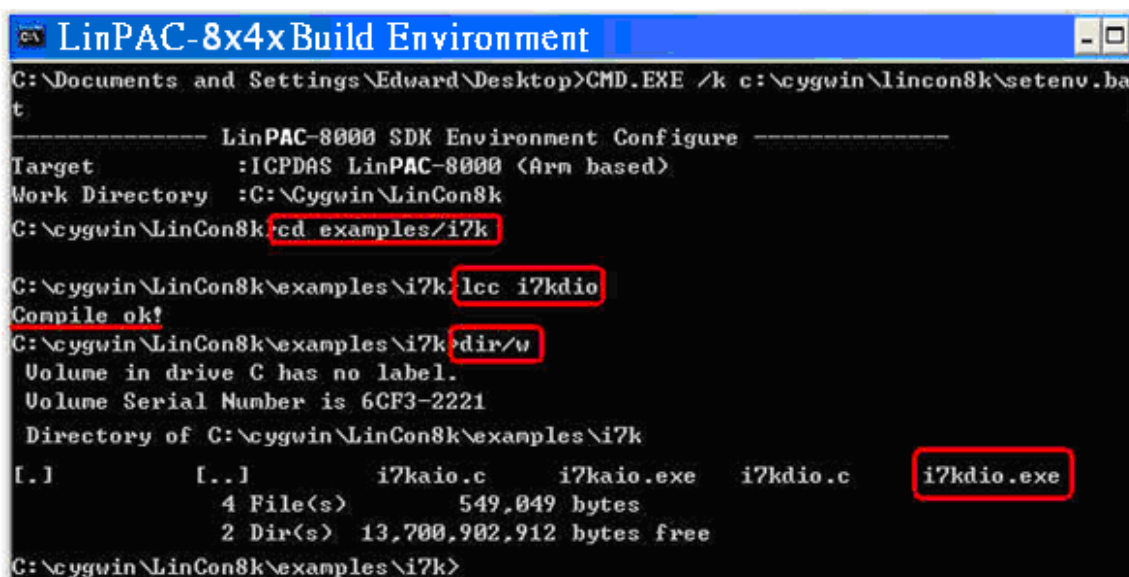
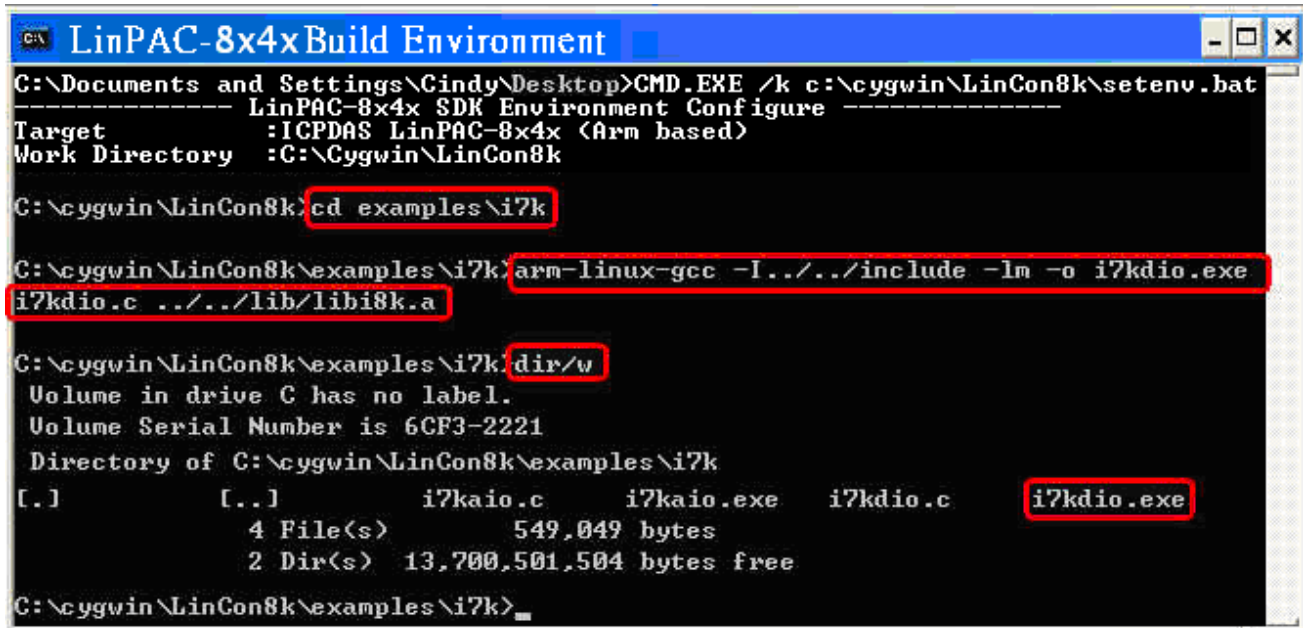

Fig. 7-1

Method Two – Using Compile Instructions

When using this method, type `cd C:\cygwin\LinCon8k\examples\i7k` command prompt to change the path. To compile `i7kdio.c` to an executable file, type `arm-linux-gnueabi-gcc -I../include -lm -o i7kdio.exe i7kdio.c ../lib/libi8k.a` (refer to Fig. 7-2).



```
C:\Documents and Settings\Cindy\Desktop>CMD.EXE /k c:\cygwin\LinCon8k\setenv.bat
----- LinPAC-8x4x SDK Environment Configure -----
Target           :ICPDAS LinPAC-8x4x (ARM based)
Work Directory   :C:\Cygwin\LinCon8k

C:\cygwin\LinCon8k>cd examples\i7k

C:\cygwin\LinCon8k\examples\i7k>arm-linux-gnueabi-gcc -I../include -lm -o i7kdio.exe
i7kdio.c ../lib/libi8k.a

C:\cygwin\LinCon8k\examples\i7k>dir/w
Volume in drive C has no label.
Volume Serial Number is 6CF3-2221
Directory of C:\cygwin\LinCon8k\examples\i7k
[.]          [..]          i7kaio.c      i7kaio.exe    i7kdio.c      i7kdio.exe
            4 File(s)          549,049 bytes
            2 Dir(s)        13,700,501,504 bytes free

C:\cygwin\LinCon8k\examples\i7k>
```

Fig. 7-2

STEP 3: Transfer i7kdio.exe to the LP-8x21

Two methods can be used to transfer the executable file to the LP-8x21, each of which is introduced here.

Method One – Using an FTP application

Step 1: Open a FTP application and create a new FTP connection. Enter the login details for the LP-8x21, including the Host name (or IP address), Username and Password. The default value for both the **User_Name** and the **Password** is “root”. Click the “**Connect**” button to connect to the ftp server on the LP-8x21. Refer to Fig.7-3 below for more details.

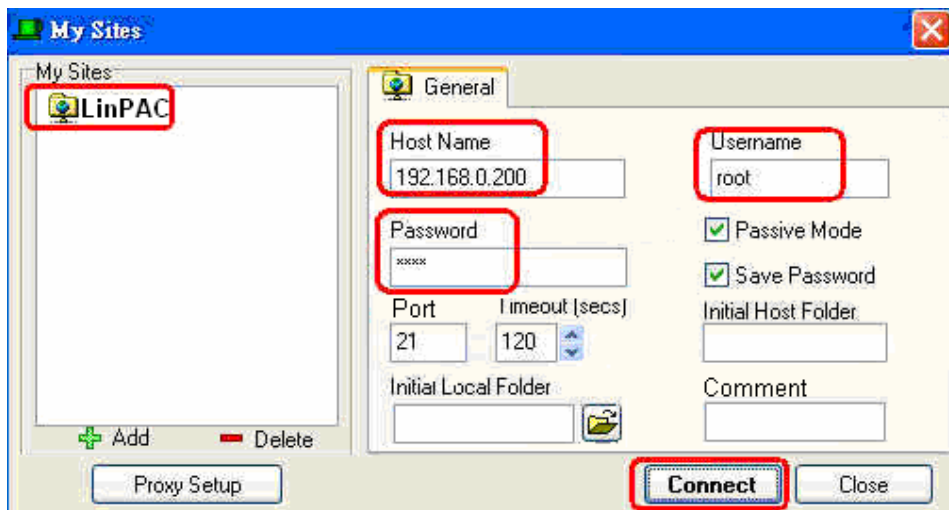

Fig.7-3

Step2: Upload the file **i7kdio.exe** file to the LP-8x21. (refer to Fig.7-4).

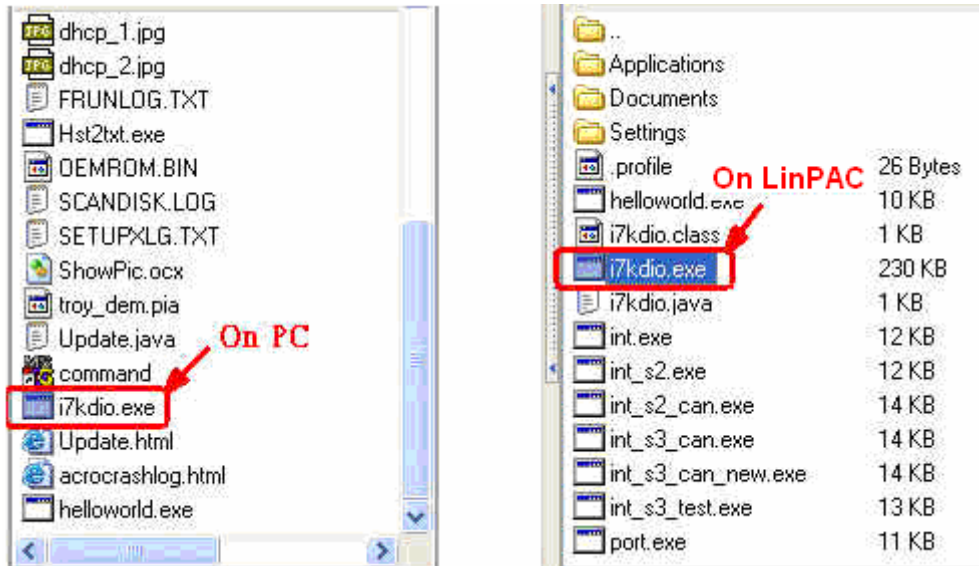

Fig.7-4

Step 3: Choose **i7kdio.exe** in the LP-8x21 and Click the right mouse button to select the **“Permissions”** option for the menu. Enter **“777”** in the Numeric textbox to set the file permissions to readable, writeable, and executable. Refer to FigS.7-5 and 7-6 below for more details.

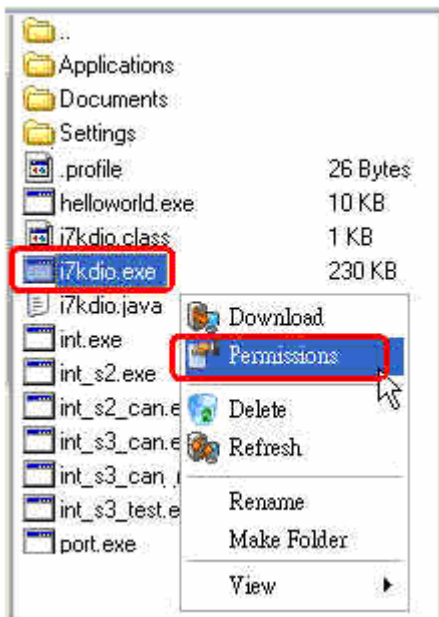

Fig.7-5

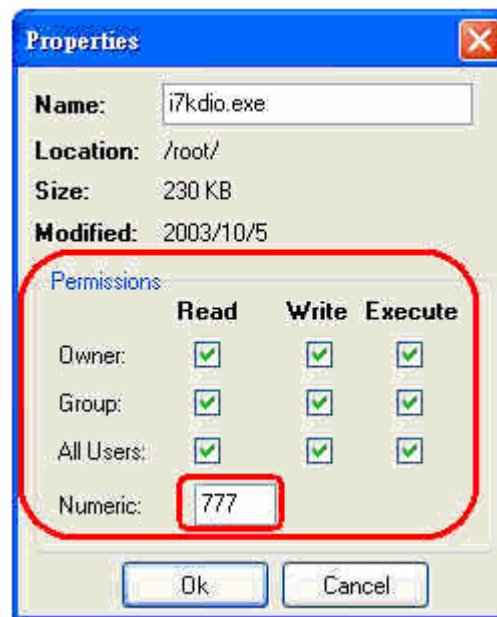

Fig.7-6

Method Two – Using a DOS Command Prompt

Open DOS Command Prompt and enter the IP Address of the server on the LP-8x21 in order to connect to the ftp server of the LP-8x21. Enter the **User Name** and **Password** (the default value is root) to login to the LP-8x21 ftp server.

Files must be transferred in binary mode, so type “**bin**” to set the mode.

At Command Prompt, type `put c:/cygwin/lincon8k/examples/i7k/i7kdio.exe i7kdio.exe` to transfer the `i7kdio.exe` file to the LP-8x21. Once the file has been transferred, the “Transfer complete” message will be displayed. Refer to Fig. 7-7 below for more details.

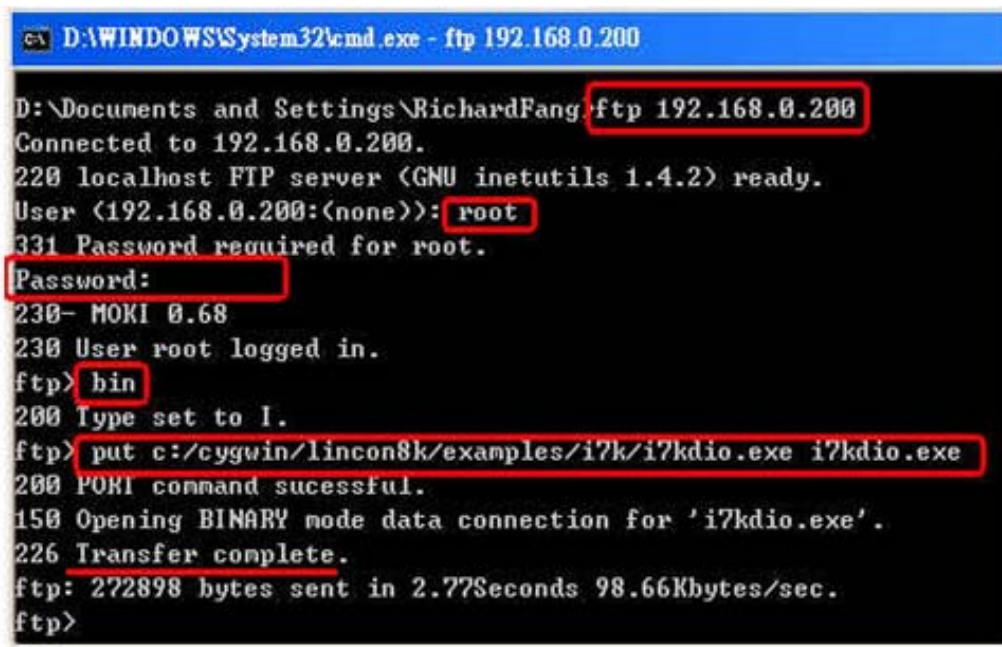

```
D:\WINDOWS\System32\cmd.exe - ftp 192.168.0.200
D:\Documents and Settings\RichardFang>ftp 192.168.0.200
Connected to 192.168.0.200.
220 localhost FTP server (GNU inetutils 1.4.2) ready.
User (192.168.0.200:(none)): root
331 Password required for root.
Password:
230- MOKI 0.68
230 User root logged in.
ftp> bin
200 Type set to I.
ftp> put c:/cygwin/lincon8k/examples/i7k/i7kdio.exe i7kdio.exe
200 PORT command successful.
150 Opening BINARY mode data connection for 'i7kdio.exe'.
226 Transfer complete.
ftp: 272898 bytes sent in 2.77Seconds 98.66Kbytes/sec.
ftp>
```

Fig. 7-7

STEP 4: Use Telnet to the LP-8x21 to execute `i7kdio.exe`

At the Command Prompt, type `telnet IP Address of the LP-8x21` to establish a connection to the LP-8x21. Enter **User Name** and **Password** (the default value is `root`) to login to the LP-8x21.

At Command Prompt, type `chmod 777 i7kdio.exe` to set the `i7kdio.exe` file to executable, and then type `i7kdio.exe` to execute the `i7kdio.exe` file. Refer to Figs. 7-8 and 7-9 below for more details.

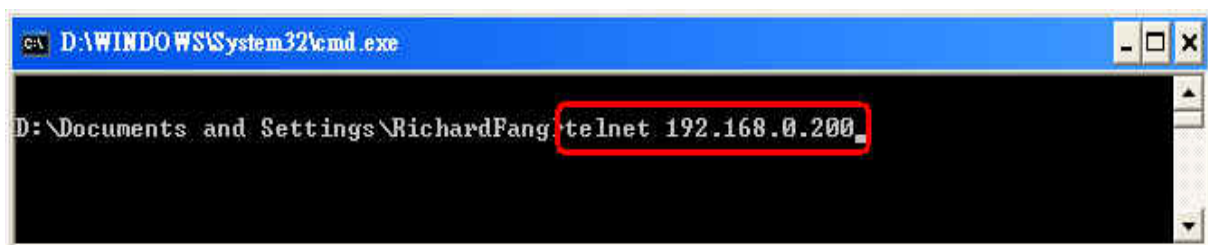

```
D:\WINDOWS\System32\cmd.exe
D:\Documents and Settings\RichardFang>telnet 192.168.0.200
```

Fig. 7-8

```
CA Telnet 192.168.0.200
LinPAC-8000 series
Linux embedded controller

linpac-8000 login: root
Password:
Distributor ID:      ICP DAS
Description:         LinPAC-8x4x
Release OS:          1.8
Codename:            PACLNX 0.90

installed modules list
slot 1 ... not installed
slot 2 ... not installed
slot 3 ... not installed
slot 4 ... not installed
#
# chmod 777 i7kdio.exe
# i7kdio.exe
The DO of 7050 : 255
The DI of 7050 : 123
#
```

Fig. 7-9

The message “**The DO of I-7050 : 255** ($=2^8 - 1$)” indicates that DO channels 0 to 7 will be used to output data, and the message “**The DI of I-7050 : 123** ($=127 - 2^2$)” indicates that DI channel 2 will be used as the input channel.

7.2 AIO Control Demo for I-7k Modules

The **i7kaio.c** demo application illustrates how to control the AI/AO functions using an I-7017 module (8 AI channels) and an I-7021 modules (1 AO channel) connected to an RS-485 network. The addresses for the I-7021 and I-7017 modules are 05 and 03, respectively, and the baudrate for both modules is 9600 bps.

The result of executing this demo program is that the AO channel on the I-7021 module will be set to output a voltage of 3.5V, and AI channel 2 on the I-7017 module will be set as the input channel. The source code for this demo program is as follows:

```
#include<stdio.h>
#include<stdlib.h>
#include "msw.h"
```

```

char szSend[80], szReceive[80];
WORD wBuf[12];
float fBuf[12];
/* ----- */
int main()
{
    int i,j, wRetVal;
    DWORD temp;

    wRetVal = Open_Com(COM3, 9600, Data8Bit, NonParity, OneStopBit);
    if (wRetVal > 0) {
        printf("open port failed!\n");
        return (-1);
    }

    //--- Analog output ----   ****   7021 -- AO   ****
    i = 0;
    wBuf[0] = 3;                // COM Port
    wBuf[1] = 0x05;            // Address
    wBuf[2] = 0x7021;          // ID
    wBuf[3] = 0;                // CheckSum disable
    wBuf[4] = 100;             // TimeOut , 100 milliseconds
    //wBuf[5] = i;              // Not used if module ID is 7016/7021
                                // Channel No.(0 to 1) if module ID is 7022
                                // Channel No.(0 to 3) if module ID is 7024

    wBuf[6] = 0;                // string debug
    fBuf[0] = 3.5;              // Analog Value

    wRetVal = AnalogOut(wBuf, fBuf, szSend, szReceive);
    if (wRetVal)                // There was an error with the Analog Output on the I-7021
        printf("AO of 7021 Error !, Error Code=%d\n", wRetVal);
    else
        printf("AO of 7021 channel %d = %f \n",i,fBuf[0]);

    //--- Analog Input ----   ****   7017 -- AI   ****
    j = 1;
    wBuf[0] = 3;                // COM Port
    wBuf[1] = 0x03;            // Address
    wBuf[2] = 0x7017;          // ID
    wBuf[3] = 0;                // CheckSum disabled
    wBuf[4] = 100;             // TimeOut , 100 milliseconds
    wBuf[5] = j;                // Channel of AI
    wBuf[6] = 0;                // Debug string

    wRetVal = AnalogIn(wBuf, fBuf, szSend, szReceive);
    if (wRetVal)                // There was an error with the Analog Input on the I-7017
        printf("AI of 7017 Error !, Error Code=%d\n", wRetVal);
    else
        printf("AI of 7017 channel %d = %f \n",j,fBuf[0]);

    Close_Com(COM3);
    return 0;
}

```

For this example, the programming and execution procedures are the same as those described in the section 7.1. Fig. 7-10 below illustrates the result of execution.

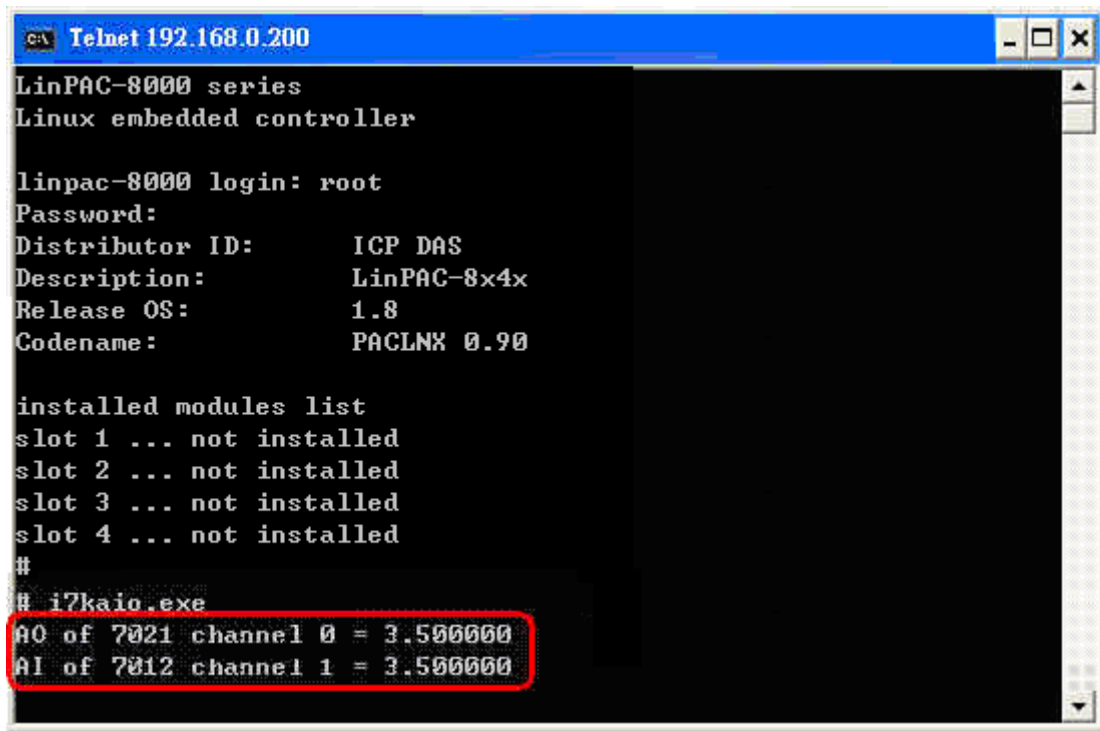

```
Telnet 192.168.0.200
LinPAC-8000 series
Linux embedded controller

linpac-8000 login: root
Password:
Distributor ID:      ICP DAS
Description:         LinPAC-8x4x
Release OS:          1.8
Codename:             PACLNx 0.90

installed modules list
slot 1 ... not installed
slot 2 ... not installed
slot 3 ... not installed
slot 4 ... not installed
#
# i7kaio.exe
AO of 7021 channel 0 = 3.500000
AI of 7012 channel 1 = 3.500000
```

Fig. 7-10

7.3 DIO Control Demo for I-87KW Modules

When using I-87KW DIO modules to perform I/O control on the LP-8x21, the program will be slightly different, depending on the location of the I-87KW modules. The code will need to be modified depending on the configuration of the I-87k modules. There are three possible variations, as described below:

- (1) If there are I-87KW DIO modules inserted **in the slots on the LP-8x21**, the “Open_Slot()” and “ChangeToSlot()” functions, must be called before other functions for the I-87KW modules and used, and the “Close_Slot()” function also needs to be called at the end of the program. Refer to the demo code provides in section 7.3.1. for more details.
- (2) If there are I-87KW DIO modules inserted **in the slots on I-87k I/O expansion unit**, refer to the demo code provided in section 7.3.2 for more information.
- (3) If there are I-87KW DIO modules inserted **in the slots on the I-8000 controller**, then these modules will be regarded as I-8KW modules. For more details, refer to the instructions for performing I/O control on I-8KW modules provided in section 7.5.2.

7.3.1 I-87KW Modules in slots of LP-8x21

The **i87kdio.c** demo program will illustrate how to control the DI/DO function using an I-87054W module (8 DO channels and 8 DI channels). The module is in slot 3 on the LP-8x21. The address and baudrate in the LP-8x21 are 00 and 115200 respectively, they were fixed by library. The result of this demo program is that DO channels 0 to 7 on the I-87054W module will be set as the output channels, and DI channel 1 on the I-87054W module will be set as the input channel. The source code for this demo program is as follows:

```
#include<stdio.h>
#include<stdlib.h>
#include "msw.h"

char szSend[80], szReceive[80];
DWORD dwBuf[12];
float fBuf[12];

int main()
{
    int i, wRetVal;
    DWORD temp;
    //Check Open_Slot
    wRetVal = Open_Slot(0);
    if (wRetVal > 0) {
        printf("open Slot failed. \n");
        return (-1);
    }
    //Check Open_Com1
    wRetVal = Open_Com(COM1, 115200, Data8Bit, NonParity, OneStopBit);
    if (wRetVal > 0) {
        printf("open port failed. \n");
        return (-1);
    }

    //Choose Slot3
    ChangeToSlot(3);

    //--- Digital Output ---- **(DigitalOut_87k())**
    dwBuf[0] = 1;           // COM Port
    dwBuf[1] = 00;         // Address
    dwBuf[2] = 0x87054;    // ID
    dwBuf[3] = 0;          // CheckSum disabled
    dwBuf[4] = 100;        // TimeOut , 100 milliseconds
    dwBuf[5] = 0xff;       // Set digital output
    dwBuf[6] = 0;          // Debug string
    wRetVal = DigitalOut_87k(dwBuf, fBuf, szSend, szReceive); // DO Output
```

```

printf("DO Value= %u", dwBuf[5]);

//--- digital Input ----  **(DigitalIn_87k())**
dwBuf[0] = 1;           // COM Port
dwBuf[1] = 00;         // Address
dwBuf[2] = 0x87054;    // ID
dwBuf[3] = 0;          // CheckSum disabled
dwBuf[4] = 100;        // TimeOut , 100 milliseconds

dwBuf[6] = 0;          // Debug string
getch();

DigitalIn_87k(dwBuf, fBuf, szSend, szReceive); // DI Input
printf("DI= %u",dwBuf[5])

//--- digital output ----  ** Close DO **
dwBuf[0] = 1;           // COM Port
dwBuf[1] = 00;         // Address
dwBuf[2] = 0x87054;    // ID
dwBuf[3] = 0;          // CheckSum disabled
dwBuf[4] = 100;        // TimeOut , 100 milliseconds
dwBuf[5] = 0x00;       // Digital output
dwBuf[6] = 0;          // Debug string
getch();                // Press any key to continue
wRetVal = DigitalOut_87k(dwBuf, fBuf, szSend, szReceive);

Close_Com(COM1);
Close_SlotAll();
return 0;
}

```

7.3.2 I-87KW Modules in slots on I-87KW I/O expansion unit

If the I-87KW DIO modules are inserted in the slots on an I-87KW I/O expansion unit, three parts of the program illustrated in section 7.3.1 above will need to be modified as follows:

- (1) The **Open_Slot()**, **ChangeToSlot()**, and **Close_SlotAll()** functions should be deleted.
- (2) The **address** and **baudrate** of any I-87KW modules connected to the RS-485 network will need to be configured using the DCON Utility, which can be downloaded from <http://www.icpdas.com/products/dcon/introduction.htm>.
- (3) The **Open com1** (i.e., the internal serial port on the LP-8x21) will need to be change to **open com3** (i.e., the RS-485 port on the LP-8x21).

The I-87054W is connected to an RS-485 network where the address is set to be 06 and the baudrate is 9600 bps, which must be configured using the DCON Utility. The source code for the **i87kdio_87k.c** demo program –is as follows:

```

#include<stdio.h>
#include<stdlib.h>
#include "msw.h"

char szSend[80], szReceive[80];
DWORD dwBuf[12];
float fBuf[12];

/* ----- */
int main()
{
    int i, wRetVal;
    DWORD temp;

    //Check Open_Com3
    wRetVal = Open_Com(COM3, 9600, Data8Bit, NonParity, OneStopBit);
    if (wRetVal > 0) {
        printf("open port failed. \n");
        return (-1);
    }

    //--- digital output ---- ** (DigitalOut_87k())**
    dwBuf[0] = 3;           // COM Port
    dwBuf[1] = 06;         // Address
    dwBuf[2] = 0x87054;     // ID
    dwBuf[3] = 0;           // CheckSum disable
    dwBuf[4] = 100;         // TimeOut , 100 milliseconds
    dwBuf[5] = 0xff;        // digital output
    dwBuf[6] = 0;           // string debug

    wRetVal = DigitalOut_87k(dwBuf, fBuf, szSend, szReceive); // DO Output
    printf("DO Value= %u", dwBuf[5]);

    //--- digital Input ---- ** (DigitalIn_87k())**
    dwBuf[0] = 3;           // COM Port
    dwBuf[1] = 06;         // Address
    dwBuf[2] = 0x87054;    // ID
    dwBuf[3] = 0;           // CheckSum disabled
    dwBuf[4] = 100;         // TimeOut , 100 milliseconds
    dwBuf[6] = 0;           // Debug string

    getch();
    DigitalIn_87k(dwBuf, fBuf, szSend, szReceive); // DI Input
    printf("DI= %u", dwBuf[5]);
}

```

```

//--- digital output ---- ** Close DO **
dwBuf[0] = 3;           // COM Port
dwBuf[1] = 06;         // Address
dwBuf[2] = 0x87054;    // ID
dwBuf[3] = 0;          // CheckSum disabled
dwBuf[4] = 100;        // TimeOut , 100 milliseconds
dwBuf[5] = 0x00;      // Digital output
dwBuf[6] = 0;          // Debug string
getch();               // Press any key to continue
wRetVal = DigitalOut_87k(dwBuf, fBuf, szSend, szReceive);

```

```

Close_Com(COM3);

```

```

return 0;
}

```

For this example, the programming and execution procedures are the same as those described in the section 7.1. Fig. 7-11 below illustrates the result of execution.

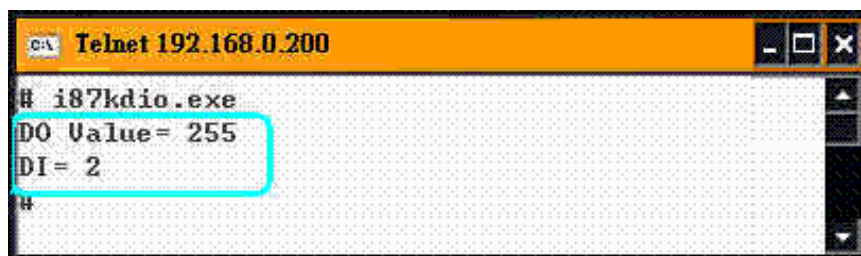

Fig. 7-11

7.3.3 I-87KW Modules in slots on I-8000 Controller

If the I-87KW DIO modules are inserted in the slots on an I-8000 controller, the I-87KW modules will be regarded as I-8KW modules. For more details, refer to the description of how to perform DI/DO control on I-8KW modules provided in the section 7.5.

7.4 AIO Control Demo for I-87KW Modules

When using I-87KW modules to perform I/O control on the LP-8x21, the program code will be slightly different depending on the location of the I-87KW modules. The code will need to be modified depending on the configuration of the I-8KW modules. There are three possible variations, as described below:

- (1) If there are I-87KW AIO modules inserted **in the slots on the LP-8x21**, the “Open_Slot” and “ChangeToSlot” functions must be called before other functions for the I-87KW modules are used, and the “Close_Slot()” function also needs to be called at the end of the program. Refer to the demo code provided in section 7.4.1.
- (2) If there are I-87KW AIO modules inserted **in the slots on the I-87k I/O expansion unit**, refer to the demo code provided in section 7.4.2 for more information.
- (3) If there are I-87KW AIO modules inserted **in the slots on the I-8000 controller**, then these modules will be regarded as I-8KW modules. For more details, refer to the instructions for performing I/O control on I-8KW modules provided in section 7.6.2.

7.4.1 I-87KW Modules in slots on an LP-8x21

The **i87kaio.c** demo program illustrates how to control the AI/AO using an the **I-87022W** module (2 AO channels) and an **I-87017W** module (8 AI channels). The I-87022W and I-87017W modules are inserted into slots 2 and 3 of the LP-8x21 reseparately. The addresses and baudrate fo both modules in the LP-8x21 are 00 and 115200 bps reseparately, they were fixed by library.

The result of executing this demo program is that AO channel 0 on the I-87022W module will be set to output a voltage of 2.5V, and AI channel 1 on the I-87017W module will be set as the input channel. The source code for this demo program is as follows:

```
#include<stdio.h>
#include<stdlib.h>
#include "msw.h"

char szSend[80], szReceive[80];
DWORD wBuf[12];
DWORD wBuf7[12];
float fBuf[12];
int main()
{
    int i,j, wRetVal;
```



```

DWORD temp;

//Check Open_Slot
wRetVal = Open_Slot(0);
if (wRetVal > 0) {
    printf("open Slot failed. \n");
    return (-1);
}

//Check Open_Com1
wRetVal = Open_Com(COM1, 115200, Data8Bit, NonParity, OneStopBit);
if (wRetVal > 0) {
    printf("open port failed. \n");
    return (-1);
}

ChangeToSlot(2);
//--- Analog output ---- **** 87022 -- AO ****
i=0;
wBuf[0] = 1;           // COM Port
wBuf[1] = 0x00;       // Address
wBuf[2] = 0x87022;   // ID
wBuf[3] = 0;         // CheckSum disable
wBuf[4] = 100;       // TimeOut , 100 milliseconds
wBuf[5] = i;         // Channel Number of AO
wBuf[6] = 0;         // string debug
fBuf[0] = 2.5;       // AO Value
wRetVal = AnalogOut_87k(wBuf, fBuf, szSend, szReceive);
if (wRetVal)          // There was an error with the Analog Output on the I-87022W
    printf("AO of 87022 Error, Error Code=%d\n", wRetVal);
else
    printf("AO of 87022 channel %d = %f \n",i,fBuf[0]);

ChangeToSlot(3);
//--- Analog Input ---- **** 87017 -- AI ****
j=1;
wBuf7[0] = 1;        // COM Port
wBuf7[1] = 0x00;     // Address
wBuf7[2] = 0x87017; // ID
wBuf7[3] = 0;       // CheckSum disabled
wBuf7[4] = 100;    // TimeOut , 100 milliseconds
wBuf7[5] = j;      //Channel Number of AI
wBuf7[6] = 0;     // Debug string
wRetVal = AnalogIn_87k(wBuf7, fBuf, szSend, szReceive);
if (wRetVal)       // There was an error with the Analog Output on the I-87017W
    printf("AI of 87017 Error, Error Code=%d\n", wRetVal);
else
    printf("AI of 87017 channel %d = %f \n",j,fBuf[0]);

Close_Com(COM1);
Close_SlotAll();
return 0;
}

```

7.4.2 I-87KW Modules in slots on an I-87KW I/O expansion unit

If the I-87KW modules are inserted in slots on an I-87KW I/O expansion unit, the three parts of the program illustrated in Section 7.4.1 above will need to be modified, as follows:

- (1) The **Open_Slot()**, **ChangeToSlot()**, and **Close_SlotAll()** functions should be deleted.
- (2) The **address** and **baudrate** of any I-87KW modules connected to the RS-485 network will need to be configured using the DCON Utility, which can be downloaded from <http://www.icpdas.com/products/dcon/introduction.htm>.
- (3) The **Open com1** (i.e., the internal serial port on the LP-8x21) will need to be changed to **open com3** (i.e., the RS-485 port on the LP-8x21)

The I-87022W and I-87017W addresses are connected to the RS-485 network and the addresses are set to 01 and 02 respectively, with the baudrate for both modules set to 9600 bps, which must be configured using the DCON Utility. The source code for the **i87kaio_87k.c** demo program is as follows:

```
#include<stdio.h>
#include<stdlib.h>
#include "msw.h"

char szSend[80], szReceive[80];
DWORD wBuf[12];
DWORD wBuf7[12];
float fBuf[12];

/* ----- */
int main()
{
    int i,j, wRetVal;
    DWORD temp;

    //Check Open_Com3
    wRetVal = Open_Com(COM3, 9600, Data8Bit, NonParity, OneStopBit);
    if (wRetVal > 0) {
        printf("open port failed. \n");
        return (-1);
    }

    //--- Analog output --- **** 87022 -- AO ****
    i=0;
    wBuf[0] = 3;           // COM Port
    wBuf[1] = 0x01;       // Address
    wBuf[2] = 0x87022;    // ID
    wBuf[3] = 0;          // CheckSum disabled
```

```

wBuf[4] = 100;           // TimeOut , 100 milliseconds
wBuf[5] = i;            // Channel Number of AO
wBuf[6] = 0;           // Debug string
fBuf[0] = 2.5;          // AO Value

wRetVal = AnalogOut_87k(wBuf, fBuf, szSend, szReceive);
if (wRetVal)
    printf("AO of 87022 Error , Error Code=%d\n", wRetVal);
else
    printf("AO of 87022 channel %d = %f \n",i,fBuf[0]);

//--- Analog Input ----  ****  87017 -- AI  ****
j=1;
wBuf7[0] = 3;           // COM Port
wBuf7[1] = 0x02;        // Address
wBuf7[2] = 0x87017;     // ID
wBuf7[3] = 0;           // CheckSum disabled
wBuf7[4] = 100;         // TimeOut , 100 milliseconds
wBuf7[5] = j;           //Channel Number of AI
wBuf7[6] = 0;           // Debug string

wRetVal = AnalogIn_87k(wBuf7, fBuf, szSend, szReceive);
if (wRetVal)
    printf("AI of 87017 Error !, Error Code=%d\n", wRetVal);
else
    printf("AI of 87017 channel %d = %f \n",j,fBuf[0]);

Close_Com(COM3);

return 0;
}

```

For this example, the programming and execution procedures are the same as those described in section 7.1. Fig. 7-12. below illustrates the result of execution.

```

c:\ Telnet 192.168.0.200
LinCon-8000 series
Linux embedded controller
lincon-8000 login: root
Password:
MOKI 0.90
# i87kain.exe
AO of 87022 channel 0 = 2.500000
AI of 87017 channel 1 = 2.507000
#

```

Fig. 7-12

7.4.3 I-87KW Modules in slots on an I-8000 Controller

If the I-87KW AIO modules are inserted in slots on an I-8000 controller, the modules will be regarded as I-8KW modules. For more details, refer to the description of how to perform AI/AO control on I-8KW modules provided in section 7.6.

7.5 DIO Control Demo for I-8KW Modules

The source file from the Libi8k.a library for -8KW modules that are inserted in the slots on an I-8000 controller is the **I8000.c** file. However, the source file from the Libi8k.a library for I-8KW modules that are inserted in the slots on the LP-8x21 is Slot.c file. Consequently, the functions used for I-8KW modules inserted in the slots on the LP-8x21 and in the slots on the I-8000 controller are completely different.

Two different demo programs can be used depend on the configuration of the I-8KW modules, as described below:

- (1) If there are I-8KW DIO modules inserted **in the slots on the LP-8x21**, refer to the demo code provided in section 7.5.1 for more information.
- (2) If there are I-8KW DIO modules inserted **in the slots on the I-8000 controller**, refer to the demo code provided in section 7.5.2 for more information.

7.5.1 I-8KW Modules in slots on an LP-8x21

The **i8kdio.c** demo program illustrates how to control the DI/DO functions using an I-8055W modules (8 DO channels and 8 DI channels) that is inserted into slot 3 on the LP-8x21.

The address and baudrate for the LP-8x21 are 00 and 115200 bps respectively, and they were fixed by library.

The result of executing this demo program is that DO channels 0 to 7 on the I-8055W module will be set as the output channels, and DI channel 0 on I-8055W module will be set as the input channel. The source code for this demo program is as follows:

```

#include<stdio.h>
#include<stdlib.h>
#include "msw.h"
char szSend[80], szReceive[80];
DWORD dwBuf[12];
float fBuf[12];
/* ----- */
int main()
{
    int i,j, wRetVal;
    WORD DOval,temp;
    wRetVal = Open_Slot(3);
    if (wRetVal > 0) {
        printf("open Slot failed. \n");
        return (-1);
    }

    //I-8055W_DO
    DO_8(3,255);
    printf("DO of I-8055 = 0x%x \n", 255);

    //I-8055W_DI
    printf("DI of I-8055 = %x",DI_8(3));

    Close_Slot(3);
    return 0;
}

```

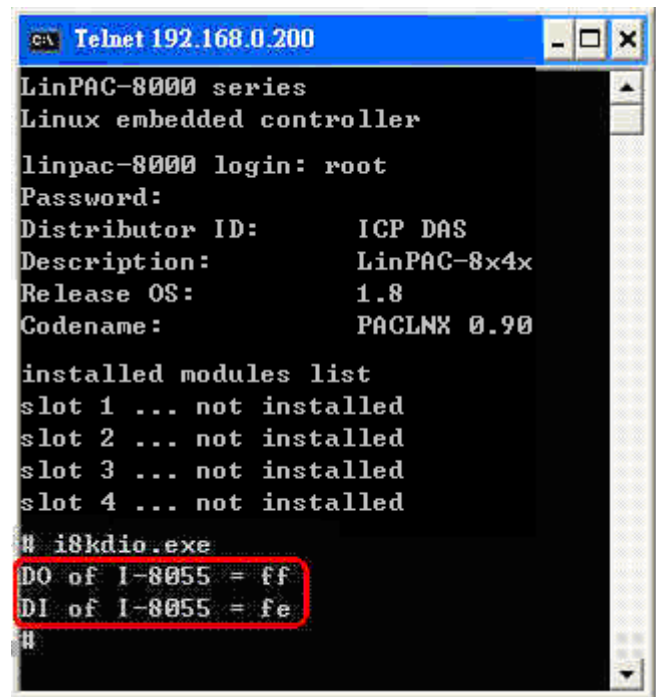

Fig. 7-13

For this example, the programming and execution procedures are the same as those described in section 7.1. Fig. 7-13 above illustrates the result of execution.

7.5.2 I-8KW Modules in slots on an I-8000 Controller

The **i8kdio_8k.c** demo program illustrates how to control the DI/DO using the I-8055W module (8 DO channels and 8 DI channels) on an I-8000 controller. Configure the hardware by following the procedure described below:

- (1) Insert the I-8055W module into slot 0 on the I-8000 controller.
- (2) Connect the **COM3** on the LP-8x21 to the COM1 on the I-8000 controller using an RS-232 cable.

The address of the I-8000 controller is 01 and the baudrate is 115200 bps, which must be configured using the DCON Utility. The result of executing this demo program is that DO

channels 0 to 7 on the I-8055W module to will be set as the output channel, and DI channel 0 on the I-8055W module will be set as input channel. The source code for this demo program is as follows:

```

#include<stdio.h>
#include<stdlib.h>
#include "msw.h"

char szSend[80], szReceive[80];
DWORD dwBuf[12];
float fBuf[12];
/* ----- */
int main()
{
    int i, wRetVal;
    DWORD temp;

    //Check Open_Com3
    wRetVal = Open_Com(COM3, 115200, Data8Bit, NonParity, OneStopBit);
    if (wRetVal > 0) {
        printf("open port failed. \n");
        return (-1);
    }

    //--- digital output ---- ** (DigitalOut_8K())**
    dwBuf[0] = 3;           // COM Port
    dwBuf[1] = 01;         // Address
    dwBuf[2] = 0x8055;     // ID
    dwBuf[3] = 0;          // CheckSum disabled
    dwBuf[4] = 100;        // TimeOut , 100 milliseconds
    dwBuf[5] = 0xff;       // Digital output
    dwBuf[6] = 0;          // Debug string
    dwBuf[7] = 1;          // slot number
    wRetVal = DigitalOut_8K(dwBuf, fBuf, szSend, szReceive);
    if (wRetVal)           // There was an error with the Analog Output on the I-8055
        printf("DO of I-8055 Error , Error Code=%d\n", wRetVal);
    else
        printf("DO of I-8055 = 0x%x" ,dwBuf[5]);

    //--- Digital Input ---- ** (DigitalIn_8K())**
    dwBuf[0] = 3;           // COM Port
    dwBuf[1] = 01;         // Address
    dwBuf[2] = 0x8055;     // ID
    dwBuf[3] = 0;          // CheckSum disabled
    dwBuf[4] = 100;        // TimeOut , 100 milliseconds
    dwBuf[6] = 0;          // Debug string
    dwBuf[7] = 1;          // slot number

```

```

getch();
Digitalln_8K(dwBuf, fBuf, szSend, szReceive);
printf("DI = %u",dwBuf[5]);

//--- Digital output ----    ** Close DO **
dwBuf[0] = 3;                // COM Port
dwBuf[1] = 01;              // Address
dwBuf[2] = 0x8055;          // ID
dwBuf[3] = 0;               // CheckSum disabled
dwBuf[4] = 100;             // TimeOut , 100 milliseconds
dwBuf[5] = 0x00;            // Digital output
dwBuf[6] = 0;               // Debug string
dwBuf[7] = 1;               // slot number

getch();                    // push any key to continue
wRetVal = DigitalOut_8K(dwBuf, fBuf, szSend, szReceive);
Close_Com(COM3);
return 0;
}

```

For this example, the programming and execution procedures are the same as those described in section 7.1. Fig. 7-14 below illustrates the result of execution.

```

c:\ Telnet 192.168.0.200
LinCon-8000 series
Linux embedded controller
lincon-8000 login: root
Password:
MOKI 0.90
# i8kdio_8k.exe
DO of 8055 = 0xff
DI = 1
#

```

Fig. 7-14

7.6 AIO Control Demo for I-8KW Modules

The source file from the Libi8k.a library for I-8KW modules inserted in the slots on an I-8000 controller is the **I8000.c** file. However, the source file from the Libi8k.a library for I-8KW modules that are inserted in the slots on the LP-8x21 is Slot.c file. Consequently, the functions used for the I-8KW modules inserted in the slot on the LP-8x21 and in the slots on the I-8000 controller are completely different.

Two different demo programs can be used depending on the configuration of the I-8KW modules, as described below:

- (1) If there are I-8KW AIO modules inserted in the slots on the LP-8x21, refer to the demo code provided in section 7.6.1 for more information.
- (2) If there are I-8KW AIO modules inserted in the slots on the I-8000 controller, refer to the demo code provided in section 7.6.2 for more information.

7.6.1 I-8KW Modules in the slots on an LP-8x21

The **i8kaio.c** demo program illustrates how to control the AI/AO functions using the I-8024W (4 AO channels) and I-8017HW (8 AI channels) modules, which are inserted in slot 1 and slot 2 on the LP-8x21 reseparately.

The address and baudrate in the LP-8x21 are 00 and 115200 bps reseparately, and they were fixed by library. The result of executing this demo is that AO voltage channel 0 on the I-8024W module to will be set to output 5.5 V and AI channel 2 on the I-8017HW module to will be set as the input channel. The source code for this demo program is as follows:

```
#include<stdio.h>
#include<stdlib.h>
#include "msw.h"

char szSend[80], szReceive[80];
DWORD dwBuf[12];
float fBuf[12];

/* ----- */
int main()
{
    int i, wRetVal,j;
    float fAi;
    int hAi, chAi, Succ;
    int Arr_hAi[5];
    float Arr_fAi[5];

    //I-8024W
    wRetVal = Open_Slot(1);
    if (wRetVal > 0) {
        printf("open Slot failed. \n");
        return (-1);
    }
}
```



```

//I8024W Initial
I8024_Initial(1);
//I8024_AO Output
I8024_VoltageOut(1,0,5.5);
Close_Slot(1);

//I-8017HW
wRetVal = Open_Slot(2);
if (wRetVal > 0) {
    printf("open Slot failed. \n");
    return (-1);
}
//I8017HW Initial
I8017_Init(2);
//I8017HW_Channel Setup
I8017_SetChannelGainMode(2,2,0,0);

// First Method : Get AI Value
hAi = I8017_GetCurAdChannel_Hex(2); //Get the uncalibrated AI Hex Value
printf("8017_AI_not_Cal_Hex =%x\n",hAi);
fAi = HEX_TO_FLOAT_Cal(hAi,2,0); //Uncalibrated AI Hex Value and then
modify it to a calibrated AI Float Value
printf("8017_AI_Cal_Float =%f\n\n",fAi);

// Second Method : Get AI Value
hAi = I8017_GetCurAdChannel_Hex_Cal(2); //Get the Calibrated AI Hex Value
printf("8017_AI_Cal_Hex =%x\n",hAi);
fAi = CalHex_TO_FLOAT(hAi,0);
//Modify the Calibrated AI Hex Value modify to a Calibrated AI Float Value
printf("8017_AI_Cal_Float =%f\n\n",fAi);

// Third Method : Get AI Value
fAi = I8017_GetCurAdChannel_Float_Cal(2); //Get the Calibrated AI Float Value
printf("8017_AI_Cal_Float =%f\n\n",fAi);

Close_Slot(2);
return 0;
}

```

For this example, the programming and execution procedures are the same as those described in section 7.1. Fig. 7-15 below illustrates the result of execution.

```
ca Telnet 192.168.0.200
LinCon-8000 series
Linux embedded controller
lincon-8000 login: root
Password:
MOKI 0.90
# i8kaio.exe
8017_AI_not_Cal_Hex =113h
8017_AI_Cal_Float =5.499573

8017_AI_Cal_Hex =4669
8017_AI_Cal_Float =5.500793

8017_AI_Cal_Float =5.500793
```

Fig. 7-15

7.6.2 I-8KW Modules in slots on an I-8000 Controller

The **i8kaio_8k.c** demo program illustrates how to control the AI/AO functions using the I-8024W (4 AO channels) and I-8017HW (8 AI channels) modules, which are inserted into slot 0 and slot 1 on the I-8000 controller. Configure the hardware by following the procedure described below:

- (1) Insert the I-8024W and I-8017HW modules in slot 0 and slot 1 on the I-8000 controller respectively.
- (2) Install 8k232.exe or R232_300.exe to flash memory of I-8000 controller as firmware.
- (3) Connect **COM3** on the LP-8x21 to COM1 on the I-8000 controller using an RS-232 cable.

The address of the I-8000 controller is 01 and baudrate is 115200 bps, which must be configured using the DCON Utility. The result of executing this demo program is that AO voltage channel 0 on the I-8024W module to will be set to output 3.5 V, and AI channel 2 on the I-8017HW module will be set as the input channel. The source code for this demo program is as follows:

```
#include<stdio.h>
#include<stdlib.h>
#include "msw.h"

char szSend[80], szReceive[80];
DWORD wBuf[12];
float fBuf[12];
```

```

int main()
{
    int i,j, wRetVal;
    DWORD temp;
    wRetVal = Open_Com(COM3, 115200, Data8Bit, NonParity, OneStopBit);
    if (wRetVal > 0) {
        printf("open port failed. \n");
        return (-1);
    }

    //--- Analog output ----   ****   8024 -- AO   ****
    i = 0;
    wBuf[0] = 3;                // COM Port
    wBuf[1] = 0x01;            // Address
    wBuf[2] = 0x8024;          // ID
    wBuf[3] = 0;                // CheckSum disabled
    wBuf[4] = 100;             // TimeOut , 100 milliseconds
    wBuf[5] = i;                // Channel No. of AO
    wBuf[6] = 0;                // Debug string
    wBuf[7] = 0;                // Slot Number
    fBuf[0] = 3.5;

    wRetVal = AnalogOut_8K(wBuf, fBuf, szSend, szReceive);
    if (wRetVal)
        printf("AO of 8024 Error, Error Code=%d\n", wRetVal);
    else
        printf("AO of 8024 channel %d = %f \n",i,fBuf[0]);

    //--- Analog Input ----   ****   8017H -- AI   ****
    j = 2;
    wBuf[0] = 3;                // COM Port
    wBuf[1] = 0x01;            // Address
    wBuf[2] = 0x8017;          // ID
    wBuf[3] = 0;                // CheckSum disabled
    wBuf[4] = 100;             // TimeOut , 100 milliseconds
    wBuf[5] = j;                // Channel of AI
    wBuf[6] = 0;                // Debug string
    wBuf[7] = 1;                // Slot Number

    wRetVal = AnalogIn_8K(wBuf, fBuf, szSend, szReceive);
    if (wRetVal)
        printf("AI of 8017H Error, Error Code=%d\n", wRetVal);
    else
        printf("AI of 8017H channel %d = %f \n",j,fBuf[0]);

    Close_Com(COM3);
    return 0;
}

```

For this example, the programming and execution procedures are the same as those described in section 7.1. Fig. 7-16 below illustrates the result of execution.

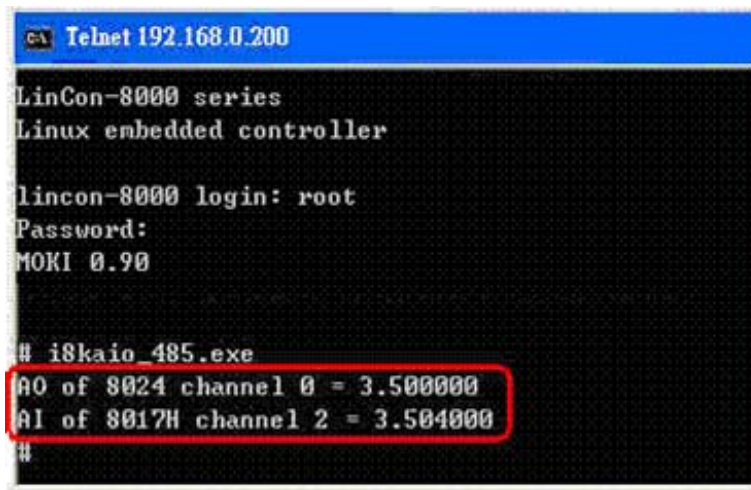

```
ca Telnet 192.168.0.200
LinCon-8000 series
Linux embedded controller

lincon-8000 login: root
Password:
MOKI 0.90

# i8kaio_485.exe
AO of 8024 channel 0 = 3.500000
AI of 8017H channel 2 = 3.504000
#
```

Fig. 7-16

7.7 Overview of the Module Control Demo Program

Fig. 7-17 provides a summary of the various communication functions that can be used depending on the for the different locations of the I-7000/I-8000/I-87000 modules when using the ICP DAS modules in conjunction with the LP-8x21, which can be helpful in understanding which communication functions should be used.

Note that the `Open_slot()/Close_Slot()` and `sio_open()/sio_close()` functions cannot be used for the same slot.

Module Location Communication Functions	I-8KW – In LP-8x21	I-87KW – In LP-8x21	I-87KW – In Expansion Unit	I-8KW or I-87KW – In I-8000 Controller	I-7K
Open_Slot()	✓	✓			
Open_Com()		✓	✓	✓	✓
Close_Slot()	✓	✓			
Close_Com()		✓	✓	✓	✓
ChangeToSlot()		✓			
sio_open() (I-811x and I-814x only)	✓				
sio_close() (I-811x and I-814x only)	✓				

Fig. 7-17

Fig. 7-18 provides an overview of the source files from the libi8k.a library that can be used depending on the different locations of I-7000/I-8000/I-87000 modules when using ICP DAS modules in conjunction with the LP-8x21, which can be helpful in understanding which source files should be called.

Module Location Source File	I7000.c	I8000.c	I87000.c	slot.c
I-7K	✓			
I-8KW or I-87KW in I-8000 Controller		✓		
I-87KW in Expansion Unit			✓	
I-87KW in LinPAC			✓	
I-8KW in LinPAC				✓

Fig. 7-18

8. Overview of the Serial Ports on the LP-8x21

The following is a description of the functionality for the three serial ports contained in the LP-8x21 embedded controller, and are based on the RS-232 or RS-485 interfaces. Fig 8-1 illustrates the ports contained on the LP-8821 and Fig 8-2 illustrates those on the LP-8121.

The information in this section is organized as follows:

- ttyO4— Internal communication with the I-87KW modules in slots
- ttyO5 – RS-232 (RxD, TxD and GND); Non-isolation; Console
- ttyS0 – RS-485 (D2+, D2-; self-tuner ASIC inside)
- ttyS1 – RS-232/RS-485
(RXD, TXD, CTS, RTS and GND for RS-232, Data+ and Data- for RS-485)
- ttyS34 – RS-232 (RXD, TXD, CTS, RTS, DSR, DTR, CD, RI and GND)

Device name	Definition in LP-8x21 SDK	Default baudrate
ttyO4	COM1	115200
ttyO5 (RS-232/console)	None	115200
ttyS0 (RS-485)	COM2	9600
ttyS1 (RS-232/485)	COM3(LP-8421/8821 only)	9600
ttyS34 (RS-232)	COM36(LP-8421/8821 only)	9600

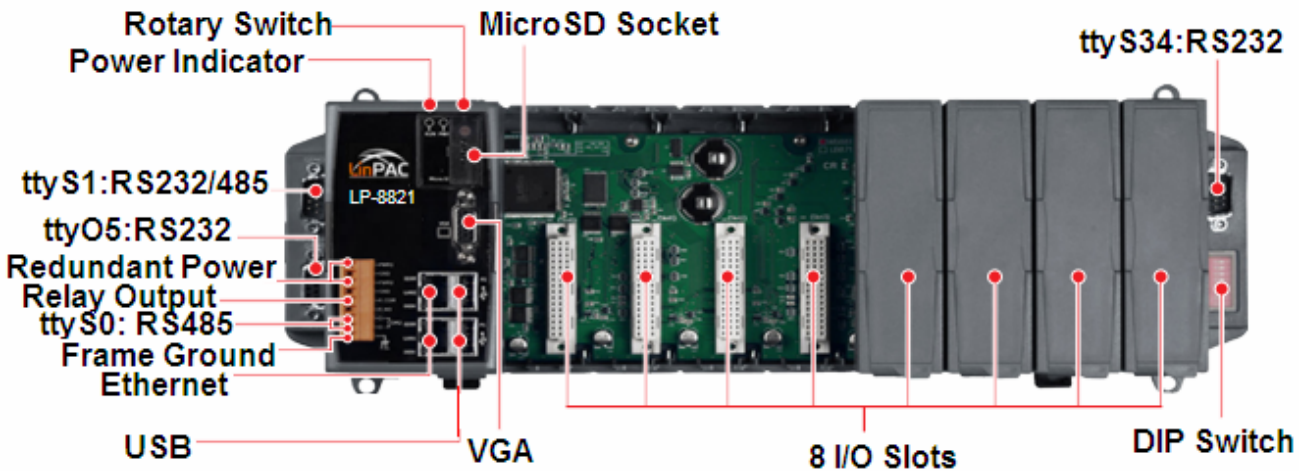

Fig. 8-1

Use the **stty** command to query or configure the COM port. For example, to modify the baudrate 9600 to 115200 bps via /dev/ttyS1 port:

```
# stty -F /dev/ttyS1 ispeed 115200 ospeed 115200
```

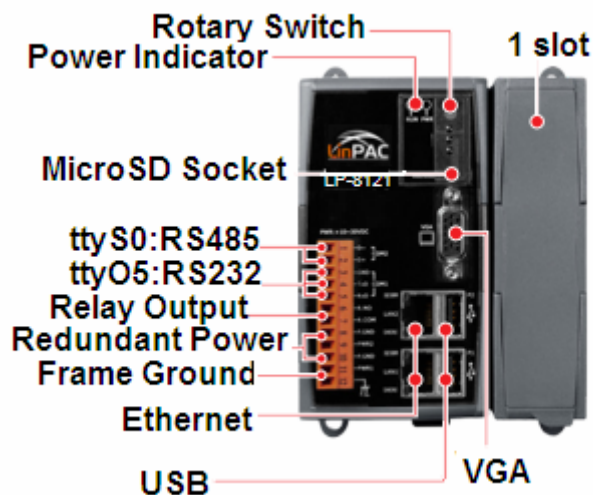

Fig. 8-2

8.1 /dev/ttyO4 Port (COM1)

The /dev/ttyO4 port is an the internal I/O expansion port on the LP-8x21, and is used to connect to an I-87KW series module inserted into the LP-8x21 embedded controller. A serial command must be used to control the I-87KW series module.

To control the I-87KW module, the Com port parameters and call the **Open_Com()** function to open the COM1 port based on the appropriate settings. Finally, call the **ChangeToSlot(slot)** function to specify which slot will be controlled. This is like the serial address, meaning that control commands can be sent to an I/O module that is inserted in the specified slot. Consequently, the serial address for the slot that contains the module is 0. A detailed example is provided below:

For Example:

```
int slot=1; char data=8, parity=0, stopbit=1 ;
unsigned char port=1;           // for all modules in COM1 port of LP-8x21
DWORD baudrate=115200;
Open_Slot(slot);
Open_Com(port, baudrate, data, parity, stopbit);
ChangeSlotToI-87k(slot);
// send command...
Close_Com(port);
Close_Slot(slot);
```

8.2 /dev/ttyS1 OR /dev/ttyS34 Port (COM3 or COM36)

This /dev/ttyS1 or /dev/ttyS34 port is located on the right-upper corner on the LP-8421/8821, and is a standard **RS-232** serial port that provides TxD, RxD, RTS, CTS, GND, non-isolated and a maximum speed of 115200 bps.

This port can also be used to connect to an I-7520 module in order to provide general RS-485 communication functionality. The /dev/ttyS1 or /dev/ttyS34 port can also be used to connect to a wireless modem so that the module can be controlled from a remote device. The application example and code is demonstrated below:

- Test using C language:

```
unsigned char port=3;
DWORD baudrate=9600;
char data=8;
char parity=0;
char stopbit=1;
Open_Com(port, baudrate, data, parity, stopbit);
// Send a command...
Close_Com(port);
```

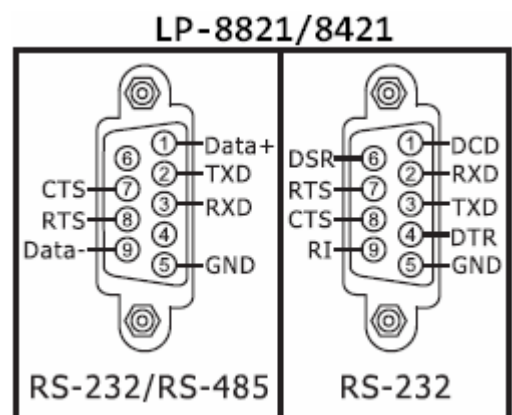

- Test using the command line interface: (PC connected to /dev/ttyS1 on the LP-8x21)

A) Open “**Hyper Terminal**” on the Host PC to monitor the test process. The default settings for COM3 port are 9600, 8, N, 1

B) Send data via /dev/ttyS1 port:

On the LP-8x21:

Type the command: **echo test>/dev/ttyS1**

Check that the word “test” is displayed on the “Hyper Terminal” screen on th PC

C) Receive data via the /dev/ttyS1 port:

On the LP-8x21:

Type the command: **cat /dev/ttyS1**

On the PC:

Enter some text in the “Hyper Terminal” screen on the PC

Check that the some words on the LP-8x21.

8.3 /dev/ttyS0 OR /dev/ttyS1 Port (COM2 or COM3)

The /dev/ttyS0 or /dev/ttyS1 port provides **RS-485** serial communication functionality (DATA+ and DATA-) and is located on the bottom-right corner on the LP-8x21. This port allow a connection to be made to modules that contain an RS-485 interface such as the I-7000, I-87k and I-8000 serial modules (DCON Module), meaning that ICP DAS I-7000/I-87k/I-8000 series modules can be directly controlled via this port with any converter. ICP DAS provides a very easy to use library of functions (libi8k.a) that can used to easily communicate with I-7000/I-87k/I-8000 series modules. Below is an application example of the program code demo.

- Test using C language:
unsigned char port=2; DWORD baudrate=9600; char data=8, parity=0, stopbit=1;
Open_Com(port, baudrate, data, char parity, stopbit);
// send command...
- Test using command line: (PC <---> i-7520 <---> /dev/ttyS on the LP-8x21 - see Fig 8-3)
 - A) Open “**Hyper Terminal**” on the Host PC to monitor the test process. The default settings for the /dev/ttyS0 port are 9600, 8, N, 1
 - B) Send data via /dev/ttyS0 port:
On the LP-8x21:
Type command: **echo test>/dev/ttyS0**
Check that the word “test” is displayed on the “Hyper Terminal” screen on the PC.
 - C) Receive data via the /dev/ttyS0 port:
On the LP-8x21:
Type the command: **cat /dev/ttyS0**
On the PC:
Enter some words in the “Hyper Terminal” screen on the PC
Check that the same text displayed on the LP-8x21.

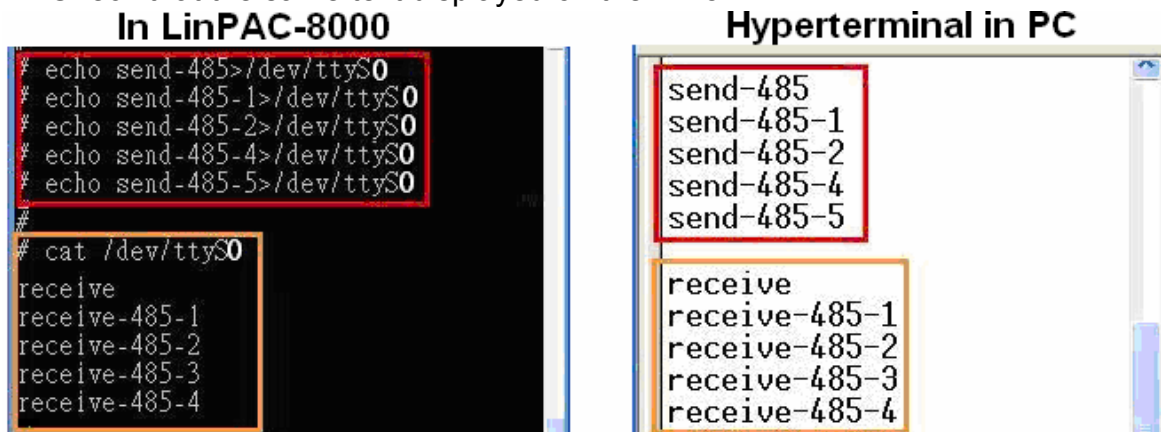

Fig. 8-3

9. Additional Support

This chapter provides additional information related to the modules supported, together with instructions that can be used to enhance the functionality and efficiency of the LP-8x21 module.

9.1 Support for N-Port Modules (I-8114W, I-8112iW, etc.)

N-port communication modules provide **two** or **four serial ports** and can be inserted into the slot of an LP-8x21 embedded controller. In this way, additional serial ports can be used on the LP-8x21 embedded controller, meaning that the maximum number of serial ports available on the LP-8x21 will be expanded to **thirty-four**.

The LP-8x21 embedded controller is a multi-tasking unit, meaning that all the serial ports can be controlled simultaneously. **The number of each serial port on the I-8114W and I-8112iW modules are presented in Figs.10-1 and 10-2.** The information illustrated in Fig. 10-5 is for the LP-8121 only, and is **fixed** based on their slot position.

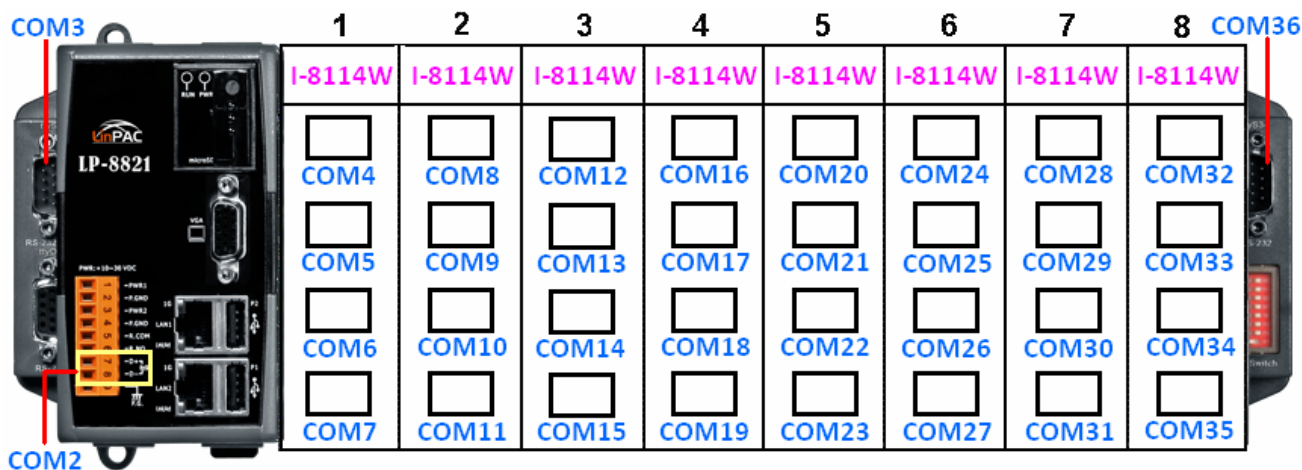

Fig.10-1

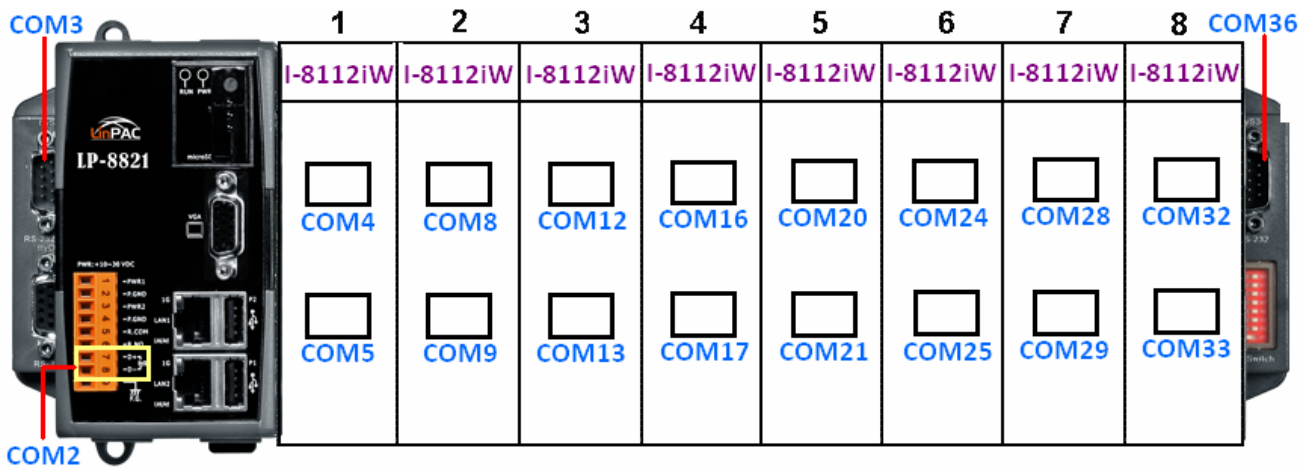

Fig.10-2

Figs.10-3 and 10-4 illustrated the serial port numbers that correspond to the **device name** on the LP-8x21.

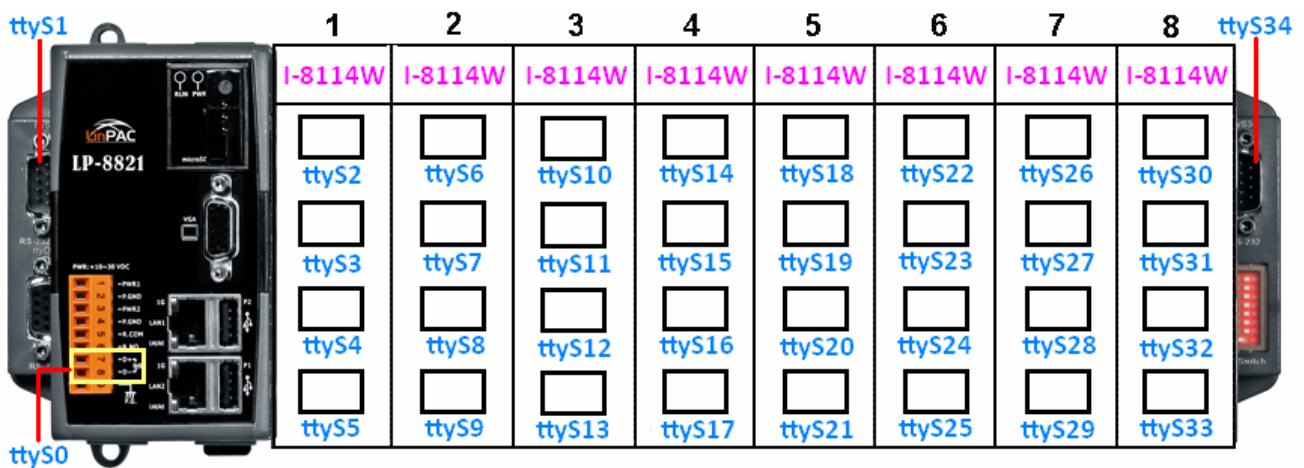

Fig.10-3

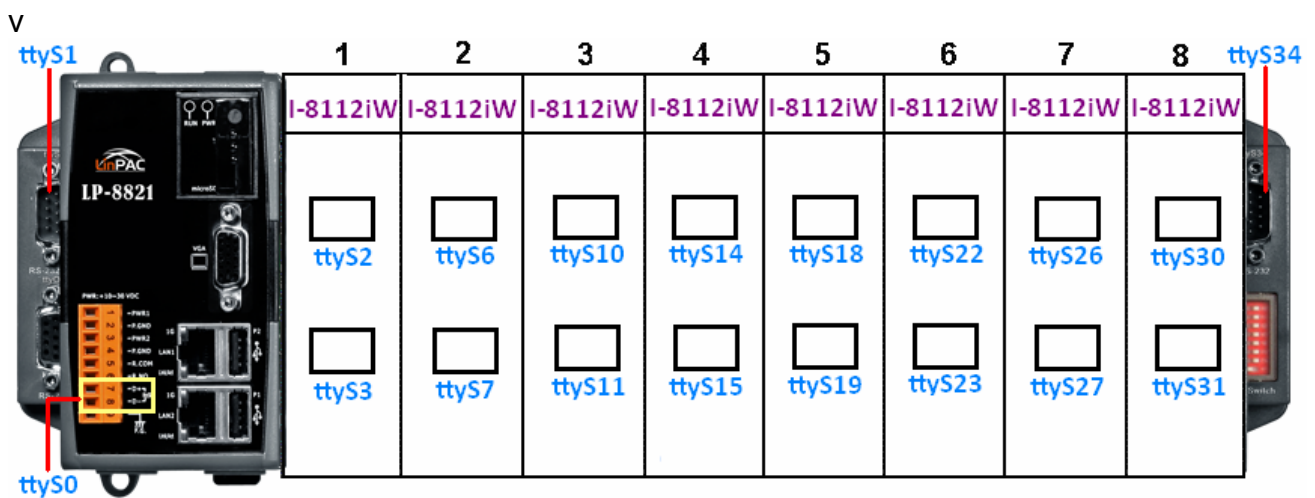

Fig.10-4

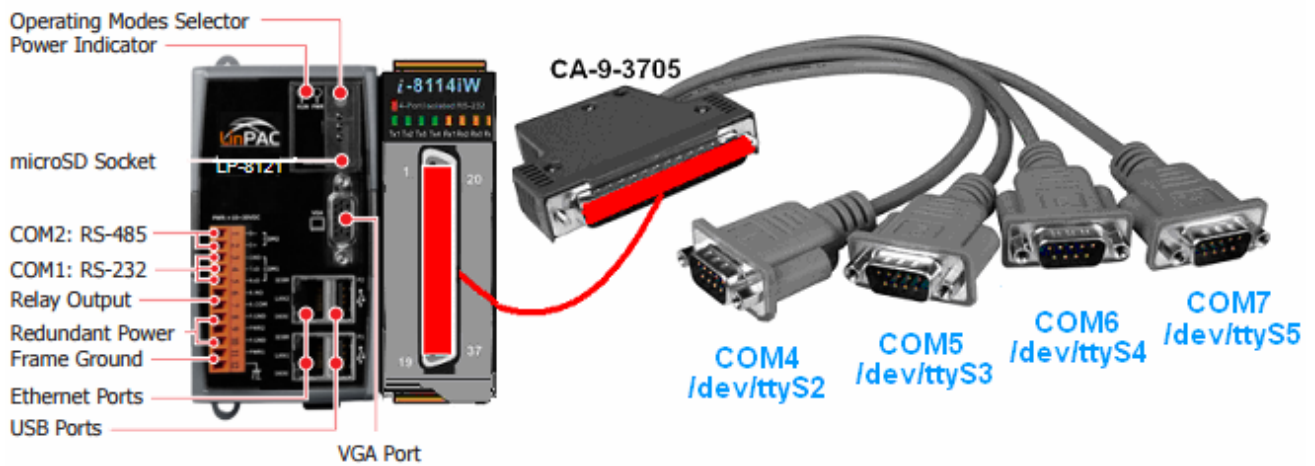

Fig.10-5

Selection guide for High-profile I-8K modules:

Module	Interface	Ports	Max. Channels	Max. Speed (Kbps)	Isolation (V)
I-8112iW	RS-232	2	16	115.2	2500
I-8114W	RS-232	4	32	115.2	—
I-8114iW	RS-232	4	32	115.2	2500
I-8142iW	RS-422/RS-485	2	16	115.2	2500
I-8144iW	RS-422/RS-485	4	32	115.2	2500

For more information relating to these modules, refer to:

http://www.icpdas.com/products/Remote_IO/i-8ke/selection_rs232_i8k.htm

The `i7kdio_8114.c` demo program illustrates how to use an I-8114W module that is inserted into an LP-8x21 embedded controller. In this demo program, the I-7044 module (8 DO and 4 DI channels) is controlled through the second serial port on the I-8114W module that is inserted into the slot 2 on the LP-8x21, which, in turn, is connected to an RS-485 network. The address of the I-7044 module is 02 and the baudrate is 115200 bps. Fig.10-6 provides an illustration of the control diagram.



Fig.10-6

The result of executing this demo program is that the state of the DO channels can be controlled, and the program returns the state of the DI channels. The source code for the demo program is as follows:

```
#include<stdio.h>
#include<stdlib.h>
#include "msw.h"
```

```
char szSend[80], szReceive[80], ans;
WORD wBuf[12];
float fBuf[12];
int main()
```

```
{
    int wRetVal, j=0;
    char i[10];
```

```
// Check Open_Com9 on the I-8114W
wRetVal = Open_Com(COM9, 115200, Data8Bit, NonParity, OneStopBit);
```

```
if (wRetVal > 0) {
    printf("Failed to open port. \n");
    return (-1);
}
```

```
// ***** 7044 DO & DI Parameters *****
wBuf[0] = 9; // COM Port
wBuf[1] = 0x02; // Address
wBuf[2] = 0x7044; // ID
wBuf[3] = 0; // Checksum disable
wBuf[4] = 100; // Timeout , 100 milliseconds
wBuf[6] = 0; // Debug string
```

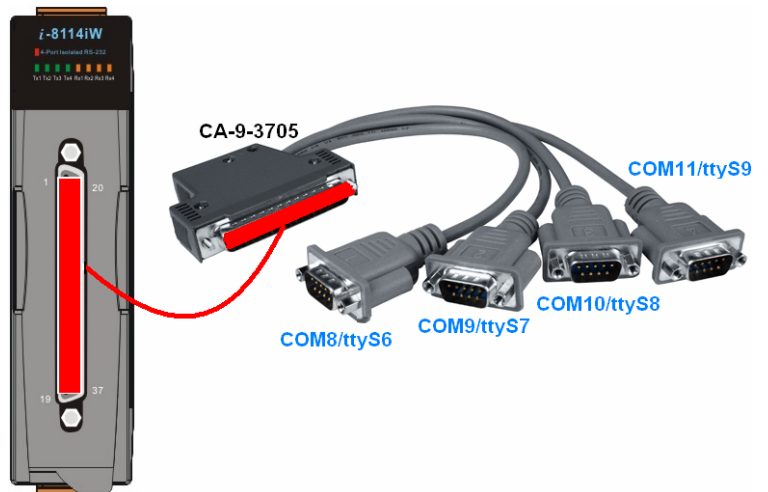

```

// 7044 DO
while(j!=113) {
    printf("Enter the DO value, or press 'q' to quit -> ");
    scanf("%s",i);

    if (i[0]=='q') {
        wBuf[5] = 0;                // All DO Channels OFF
        wRetVal = DigitalOut(wBuf, fBuf, szSend, szReceive);
        break;
    }
    j=atoi(i);
    if (j>=0 & j<=255)
        wBuf[5] = j;                // DO Channels ON
    else if (j>255)
        wBuf[5] = 255;

    wRetVal = DigitalOut(wBuf, fBuf, szSend, szReceive);
    if (wRetVal)                    // There was an error with the Digital Output on the I-7044
        printf("Digital Output of 7044 is error, Error Code=%d\n", wRetVal);
    else
        printf("The DO value of 7044 is: %u \n", wBuf[5]);

    // 7044 DI
    DigitalIn(wBuf, fBuf, szSend, szReceive);
    printf("The DI of 7044 : %u \n", wBuf[5]);
}
Close_Com(COM9);
return 0;
}

```

For this example, the programming and execution procedures are the same as those described in Section 7.1. Fig. 10-7 below illustrates the result of the execution.

```

Telnet 192.168.0.200
#
# i7kdio_8114.exe
Input DO value or press 'q' to quit!! -> 3
The DO of 7044 : 3
The DI of 7044 : 14
Input DO value or press 'q' to quit!! -> q
#

```

Fig. 10-7

Appendix A. Service Information

This appendix will show how to contact ICP DAS when you have problems in the LP-8x21 or other products.

Internet Service :

The [internet service](#) provided by ICP DAS will be satisfied and it includes [Technical Support](#), [Driver Update](#), [OS_Image](#), [LinPAC_SDK](#) and [User's Manual Download](#) etc. Users can refer to the following web site to get more information :

1. ICP DAS Web Site :

<http://www.icpdas.com>

1. Software Download :

<http://www.icpdas.com/download/index.htm>

3. Java Supported Document :

<http://www.icpdas.com/download/java/index.htm>

4. E-mail for Technical Support :

service@icpdas.com

service.icpdas@gmail.com

Appendix B. Redundant Power

The LinPAC provides two power inputs that can be connected simultaneously to live DC power sources. If one of the power inputs fails, the other live source acts as a backup to automatically support the LinPAC's power needs.

The LinPAC provides relay contact outputs to warn technicians on the shop floor when the power fails.

