

L2+ 8-Port 10/100/1000T 802.3at PoE + 2-Port 10/100/1000T + 2-Port 100/1000X SFP Managed Switch

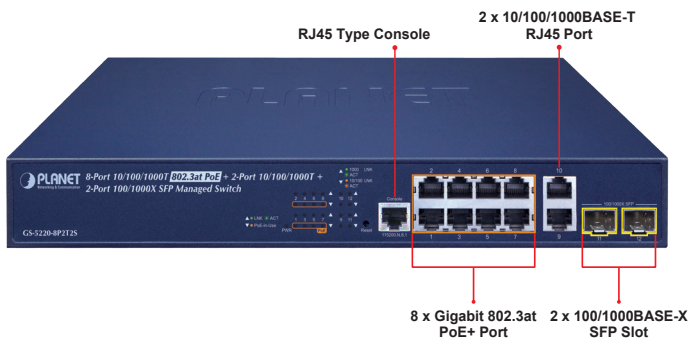

Perfect Managed PoE+ Switch with L2+/L4 Switching and Security

PLANET GS-5220-8P2T2S Layer 2 Managed Gigabit Switch supports both **IPv4 and IPv6 protocols** and **Layer 3 static routing**, and provides **8 10/100/1000BASE-T ports** featuring **36-watt 802.3at PoE+**, **2 additional Gigabit copper ports** and another **2 extra 100/1000BASE-X SFP fiber slots**. Each of the eight Gigabit ports provides 36 watts of power, with a total power budget of up to **240 watts** for the different types of PoE applications being employed. It provides a quick, safe and cost-effective Power over Ethernet network solution to IP security surveillance for small businesses and enterprises.



Network with Cybersecurity Helps Minimize Security Risks

The GS-5220-8P2T2S comes with enhanced cybersecurity to fend off cyberthreats and cyberattacks, it supports SSHv2, TLSv1.2, SNMPv3 protocols to provide strong protection against advanced threats. Served as a key point to transmit data to customer's critical equipment in a business network, the cybersecurity feature of the GS-5220-8P2T2S protects the switch management and enhances the security of the mission-critical network without any extra deployment cost and effort.



Physical Port

- 10-Port 10/100/1000BASE-T RJ45 copper with 8-Port IEEE 802.3at/af Power over Ethernet Injector function
- 2 100/1000BASE-X mini-GBIC/SFP slots
- RJ45 console interface for basic management and setup

Power over Ethernet

- Complies with IEEE 802.3at Power over Ethernet Plus/end-span PSE
- Up to 8 IEEE 802.3af/802.3at devices powered
- Supports PoE power up to 36 watts for each PoE port
- Auto detects powered device (PD)
- Circuit protection prevents power interference between ports
- Remote power feeding up to 100 meters in standard mode and 250m in extended mode
- PoE management features
 - PoE admin-mode control
 - PoE management mode selection
 - Per port PoE function enable/disable
 - PoE port power feeding priority
 - Per PoE port power limit
 - PoE Port Status monitoring
 - PD classification detection
 - Sequence port PoE
 - PoE extension
- Intelligent PoE features
 - Temperature threshold control
 - PoE usage threshold control
 - PoE schedule
 - PD alive check
 - LLDP PoE neighbors

Layer 2 Features

- Prevents packet loss with back pressure (half-duplex) and IEEE 802.3x pause frame flow control (full-duplex)
- High performance of Store-and-Forward architecture and runt/CRC filtering eliminates erroneous packets to optimize the network bandwidth
- Storm Control support
 - Broadcast/Multicast/Unicast

Built-in Unique PoE Functions for Surveillance Management

As a managed PoE Switch for surveillance network, the GS-5220-8P2T2S features the following intelligent PoE management functions:

- PoE Schedule
- PD Alive Check
- Scheduled Power Recycling
- SMTP/SNMP Trap Event Alert

PoE Schedule for Energy Saving

Besides being used for IP surveillance, the GS-5220-8P2T2S is certainly applicable to build any PoE network including VoIP and wireless LAN. Under the trend of energy saving worldwide and contributing to the environmental protection on the Earth, the GS-5220-8P2T2S can effectively control the power supply besides its capability of giving high watts power. The “PoE schedule” function helps you to enable or disable PoE power feeding for each PoE port during specified time intervals and it is a powerful function to help SMBs and enterprises save energy and budget.

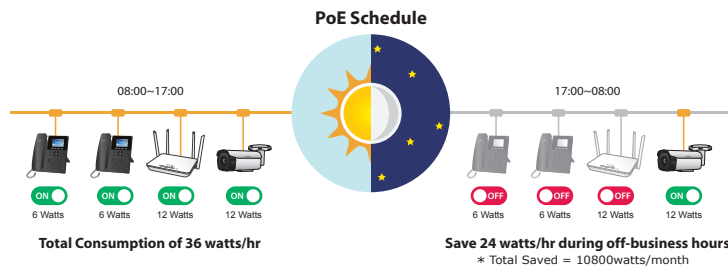

Intelligent Powered Device Alive Check

The GS-5220-8P2T2S can be configured to monitor a connected PD status in real time via ping action. Once the PD stops working and it is without response, the GS-5220-8P2T2S will resume the PoE port power and bring the PD back to work. It will greatly enhance the network reliability through the PoE port resetting the PD's power source, thus reducing administrator management burden.

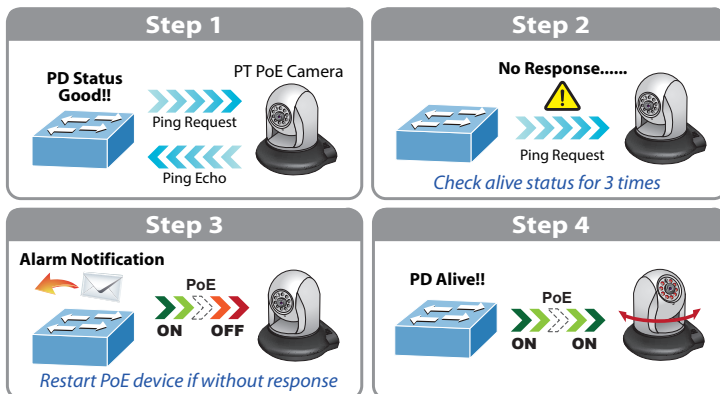

- Supports **VLAN**
 - IEEE 802.1Q tagged VLAN
 - Up to 4K VLANs groups, out of 4095 VLAN IDs
 - Supports provider bridging (VLAN Q-in-Q, IEEE 802.1ad)
 - Private VLAN Edge (PVE)
 - Port Isolation
 - MAC-based VLAN
 - IP Subnet-based VLAN
 - Protocol-based VLAN
 - VLAN Translation
 - Voice VLAN
 - GVRP
- Supports **Spanning Tree Protocol**
 - IEEE 802.1D Spanning Tree Protocol
 - IEEE 802.1w Rapid Spanning Tree Protocol
 - IEEE 802.1s Multiple Spanning Tree Protocol, spanning tree by VLAN
 - BPDU Filtering/BPDU Guard
- Supports **Link Aggregation**
 - 802.3ad Link Aggregation Control Protocol (LACP)
 - Cisco ether-channel (static trunk)
 - Maximum 6 trunk groups, up to 12 ports per trunk group
 - Up to 24Gbps bandwidth (full duplex mode)
- Provides port mirror (many-to-1)
- Port back up function
- Port mirroring to monitor the incoming or outgoing traffic on a particular port
- Loop protection to avoid broadcast loops
- Compatible with Cisco uni-directional link detection(UDLD) that monitors a link between two switches and blocks the ports on both ends of the link if the link fails at any point between the two devices

Layer 3 IP Routing Features

- Supports maximum 32 static routes and route summarization

Quality of Service

- Ingress Shaper and Egress Rate Limit per port bandwidth control
- 8 priority queues on all switch ports
- Traffic classification
 - IEEE 802.1p CoS
 - TOS/DSCP / IP Precedence of IPv4/IPv6 packets

Scheduled Power Recycling

The GS-5220-8P2T2S allows each of the connected PDs to reboot at a specified time each week. Therefore, it will reduce the chance of PD crash resulting from buffer overflow.

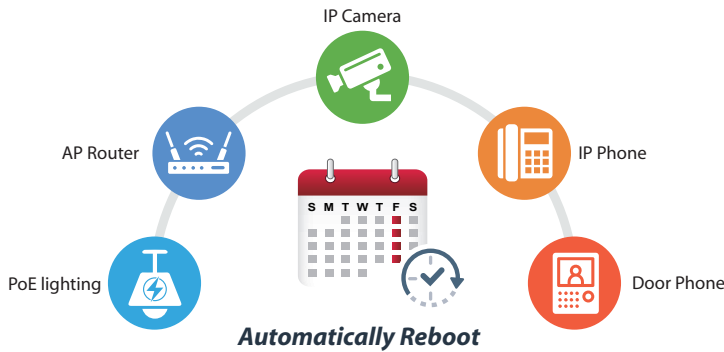

SMTP/SNMP Trap Event Alert

Though most NVR or camera management software offers SMTP email alert function, the GS-5220-8P2T2S further provides event alert function to help to diagnose the abnormal device owing to whether or not there is a break of the network connection, loss of PoE power or the rebooting response by the PD Alive Check process.

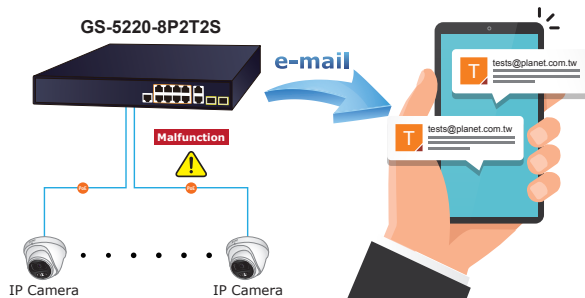

Convenient and Smart ONVIF Devices with Detection Feature

PLANET has newly developed an awesome feature -- ONVIF Support -- which is specifically designed for cooperating with video IP surveillances. From the GS-5220-8P2T2S GUI, you just need one click to search and show all of the ONVIF devices via network application. In addition, you can upload floor images to the switch and remotely monitor what is going on in the production line. Moreover, you can get real-time surveillance's information and online/offline status, and can have PoE reboot control from GUI.



- IP TCP/UDP port number
- Typical network application
- Strict priority and Weighted Round Robin (WRR) CoS policies
- Supports QoS and In/Out bandwidth control on each port
- Traffic-policing policies on the switch port
- DSCP remarking

Multicast

- Supports IPv4 IGMP Snooping v1, v2 and v3
- Supports IPv6 MLD Snooping v1 and v2
- Querier mode support
- IPv4 IGMP Snooping port filtering
- IPv6 MLD Snooping port filtering
- Multicast VLAN Registration (MVR) support

Security

- Authentication
 - IEEE 802.1x Port-based / MAC-based network access authentication
 - Built-in RADIUS client to co-operate with the RADIUS servers
 - TACACS+ login users access authentication
 - RADIUS/TACACS+ users access authentication
- Access Control List
 - IP-based Access Control List (ACL)
 - MAC-based Access Control List
- Source MAC/IP address binding
- **DHCP Snooping** to filter un-trusted DHCP messages
- **Dynamic ARP Inspection** discards ARP packets with invalid MAC address to IP address binding
- **IP Source Guard** prevents IP spoofing attacks
- IP address access management to prevent unauthorized intruder

Management

- IPv4 and IPv6 dual stack management
- Switch Management Interfaces
 - Web switch management
 - Console/Telnet Command Line Interface
 - SNMP v1 and v2c switch management
 - SSHv2, TLSv1.2 and SNMP v3 secure access
- **IPv6** IP Address/NTP/DNS management
- Built-in Trivial File Transfer Protocol (TFTP) client
- BOOTP and DHCP for IP address assignment

Solution for IPv6 Networking

With the support for IPv6/IPv4 protocol, and easy and friendly management interfaces, the GS-5220-8P2T2S is the best choice for IP surveillance, VoIP and wireless service providers to connect with the IPv6 network. It also helps SMBs to step in the IPv6 era with the lowest investment and without having to replace the network facilities even though ISPs establish the IPv6 FTTx edge network.

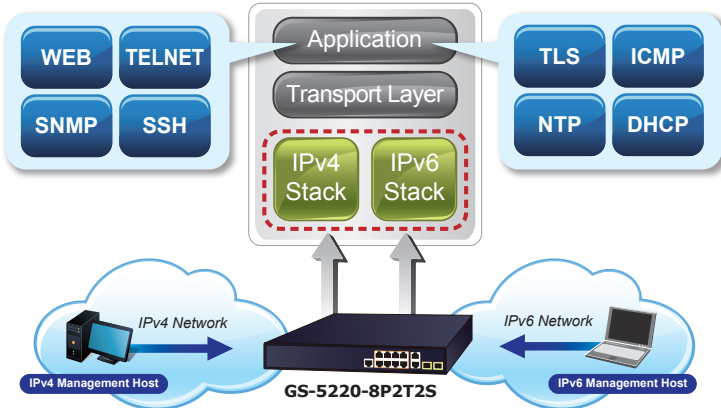

IPv4 and IPv6 VLAN Routing for Secure and Flexible Management

To help customers stay on top of their businesses, the GS-5220-8P2T2S not only provides ultra high transmission performance and excellent layer 2 technologies, but also offers IPv4/IPv6 VLAN routing feature which allows to crossover different VLANs and different IP addresses for the purpose of having a highly-secure, flexible management and simpler networking application.

Robust Layer 2 Features

The GS-5220-8P2T2S can be programmed for advanced switch management function, such as dynamic port link aggregation, **Q-in-Q VLAN**, **Multiple Spanning Tree Protocol (MSTP)**, Layer 2/4 QoS, bandwidth control and **IGMP/MLD snooping**. The GS-5220-8P2T2S allows the operation of a high-speed trunk combining multiple ports. Supporting 6 trunk groups, it enables a maximum of up to 12 ports per trunk and supports connection fail-over as well.

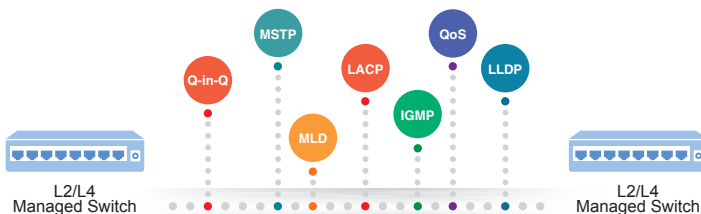

Powerful Security

The GS-5220-8P2T2S offers comprehensive **layer 2 to layer 4 access control list (ACL)** for enforcing security to the edge. It can be used to restrict network access by denying packets based on source and destination IP address, TCP/UDP port number or defined typical network applications. Its protection mechanism also comprises **802.1x Port-based** and **MAC-based** user and device authentication. With the **private VLAN** function, communication between edge ports can be prevented to ensure user privacy.

- System Maintenance
 - Firmware upload/download via HTTP
 - Reset button for system reboot or reset to factory default
 - Dual Images
- DHCP Relay
- DHCP Option82
- DHCP Server
- User Privilege levels control
- NTP (Network Time Protocol)
- UPnP
- Link Layer Discovery Protocol (LLDP) and LLDP-MED
- Network Diagnostic
 - SFP-DDM (Digital Diagnostic Monitor)
 - ICMPv6/ICMPv4 Remote Ping
 - Cable Diagnostic technology provides the mechanism to detect and report potential cabling issues
- SMTP/Syslog remote alarm
- Four RMON groups (history, statistics, alarms and events)
- SNMP trap for interface Linkup and Linkdown notification
 - System Log
 - PLANET Smart Discovery Utility for deployment management
 - PLANET NMS system and CloudViewer for deployment management
 - Provides ONVIF for co-operating with PLANET video IP surveillances

Enhanced Security and Traffic Control

The GS-5220-8P2T2S also provides **DHCP Snooping**, **IP Source Guard** and **Dynamic ARP Inspection** functions to prevent IP snooping from attack and discard ARP packets with invalid MAC address. The network administrator can now build highly-secure corporate networks with considerably less time and effort than before.

User-friendly Secure Management

For efficient management, the GS-5220-8P2T2S is equipped with console, web and SNMP management interfaces. With the built-in web-based management interface, the GS-5220-8P2T2S offers an easy-to-use, platform independent management and configuration facility. The GS-5220-8P2T2S supports SNMP and it can be managed via any management software based on the standard SNMP v1 and v2 protocols. For reducing product learning time, the GS-5220-8P2T2S offers Cisco-like command via Telnet or console port and customer doesn't need to learn new command from these switches. Moreover, the GS-5220-8P2T2S offers remote secure management by supporting SSHv2, TLSv1.2, SNMPv3 connection which can encrypt the packet content at each session.



Flexible and Extendable Solution

The 2 mini-GBIC SFP slots built in the GS-5220-8P2T2S support dual speed as it features 100BASE-FX and 1000BASE-SX/LX SFP (Small Form-factor Pluggable) fiber-optic modules. Now the administrator can flexibly choose the suitable SFP transceiver according to not only the transmission distance, but also the transmission speed required. The distance can be extended from 550 meters to 2km (multi-mode fiber) and up to 10/20/40/60/80/120 kilometers (single-mode fiber or WDM fiber). They are well suited for applications within the enterprise data centers and distributions.

Intelligent SFP Diagnosis Mechanism

The GS-5220-8P2T2S supports **SFP-DDM (Digital Diagnostic Monitor)** function that greatly helps network administrator to easily monitor real-time parameters of the SFP transceivers, such as optical output power, optical input power, temperature, laser bias current, and transceiver supply voltage.

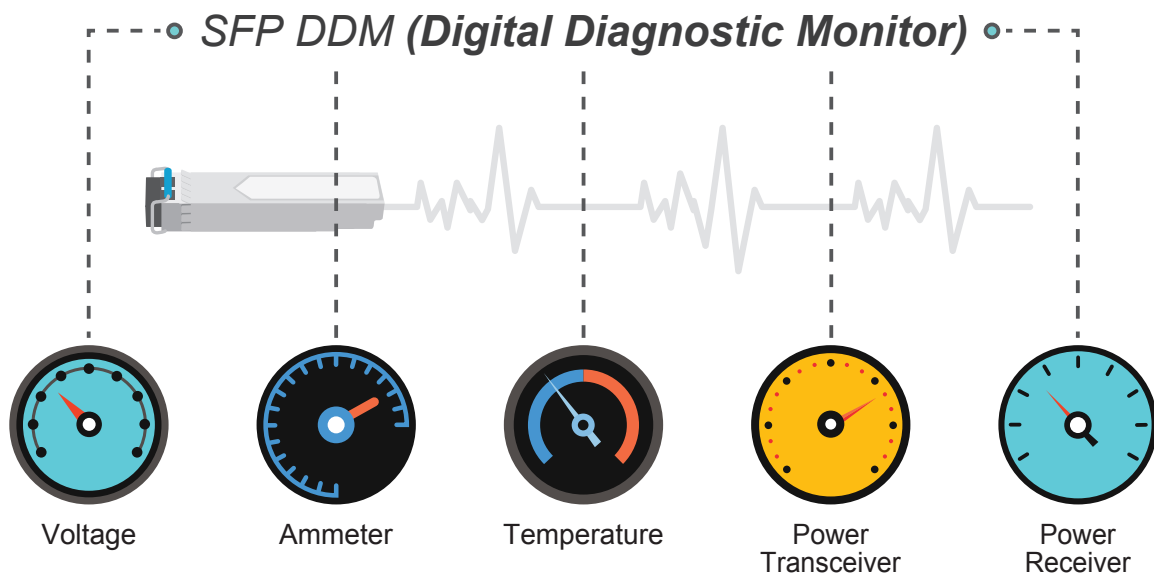

Applications

IP Office Department/Workgroup PoE Switch

As the business expands, the additional telephones required could be installed at less cost via the implementation of PoE IP telephony system than that of the traditional circuit wiring telephony system. The GS-5220-8P2T2S helps enterprises to efficiently create an integrated data, voice, and powered VoIP network. Any IEEE 802.3af/at compliant IP phones can be installed without any power cable because it can be powered via the standard Ethernet cable from the connected GS-5220-8P2T2S. With the GS-5220-8P2T2S, IP telephony deployment becomes more reliable and cost effective, which helps enterprises save tremendous cost when upgrading from the traditional telephony system to IP telephony communications infrastructure.

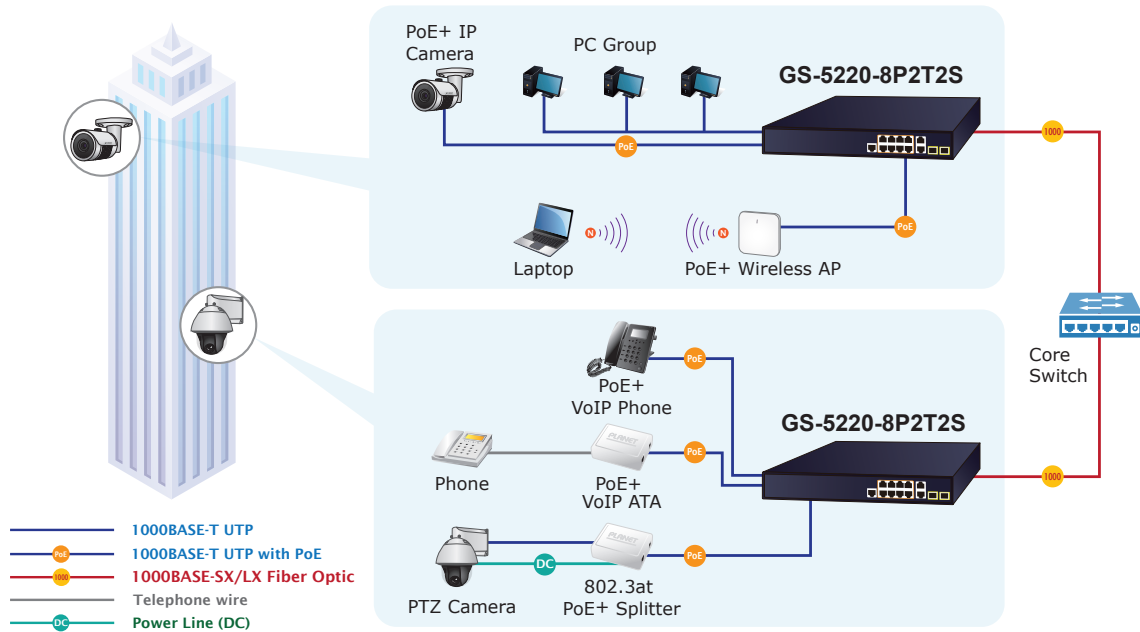

Layer 2+ VLAN Static Routing and PoE Application

With the built-in robust IPv4/IPv6 Layer 3 traffic routing protocols, the GS-5220-8P2T2S ensures reliable routing between VLANs and network segments. The routing protocols can be applied by VLAN interface with up to 32 routing entries. The GS-5220-8P2T2S is certainly a cost-effective and ideal solution for enterprises.

Providing up to 8 Gigabit PoE+ ports and in-line power interface, the GS-5220-8P2T2S PoE+ Managed Switch can easily build a centrally-controlled power network shared by wireless Gigabit AP, IP phone system, or mega-pixel IP camera system group for the enterprises.

VLAN Routing + PoE Applications

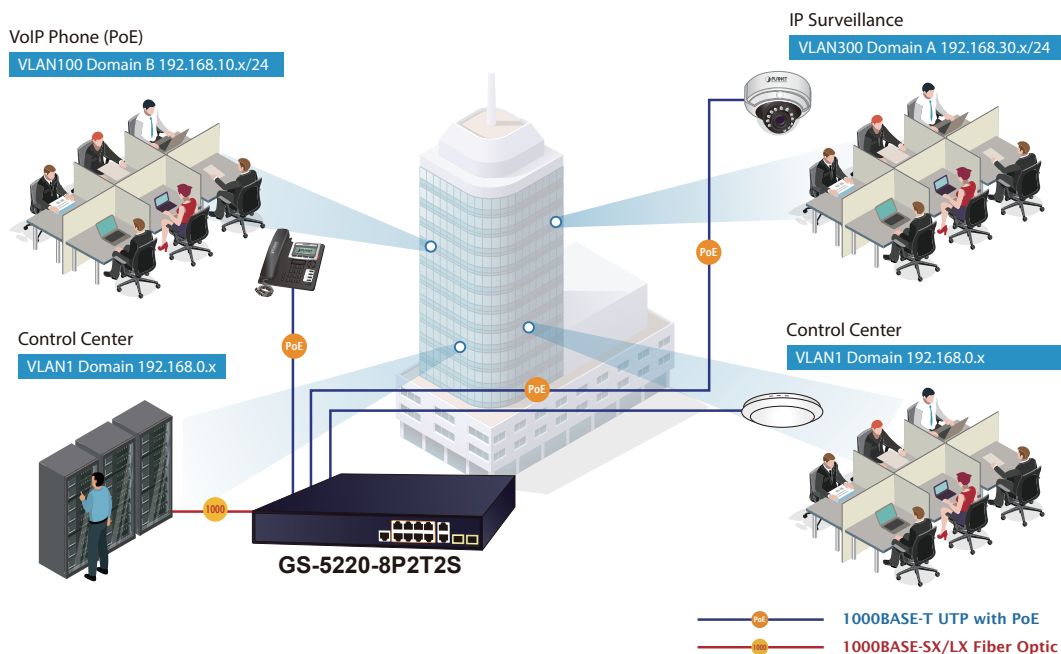

Specifications

Product	GS-5220-8P2T2S
Hardware Specifications	
Copper Ports	10 10/ 100/1000BASE-T RJ45 auto-MDI/MDI-X ports
SFP mini-GBIC Interfaces	2 x 100/1000BASE-X SFP interfaces with Port-11 to Port-12 Supports 100/1000Mbps dual mode and DDM
PoE Injector Port	8 ports with 802.3at/af PoE injector function with Port-1 to Port-8
Console	1 x RJ45 serial port (115200, 8, N, 1)
Reset Button	< 5 sec: System reboot > 5 sec: Factory Default
Smart Fan	1
Power Requirements	100~240V AC, 50/60Hz, 4A
Power Consumption (Full Loading)	282 watts/962BTU
ESD Protection	6KV DC
Dimensions (W x D x H)	330 x 200 x 44 mm, 1U high
Weight	3.9 kg
LED	<p>System: Power (Green)</p> <p>PoE Ethernet Interfaces (Port 1 to Port 8): LNK/ACT (10/100/1000Mbps, Green), PoE In-Use (Amber)</p> <p>10/100/1000BASE-T Ports (Port 9 to port 10): 1000 (LNK/ACT, Green), 10/100 (LNK/ACT, Amber)</p> <p>100/1000Mbps SFP Interfaces (Port 11 to Port 12): 1000 (LNK/ACT, Green), 100 (LNK/ACT, Amber)</p>
Switching	
Switch Architecture	Store-and-Forward
Switch Fabric	24Gbps /non-blocking
Throughput	17.76Mpps@64Bytes
Address Table	8K entries, automatic source address learning and ageing
SDRAM	128Mbytes
Flash	64Mbytes
Flow Control	IEEE 802.3x pause frame for full duplex Back pressure for half duplex
Jumbo Frame	9K bytes
Power over Ethernet Specifications	
PoE Standard	IEEE 802.3at Power over Ethernet Plus PSE
PoE Power Supply Type	End-span
PoE Power Output	Per port 54V DC, 590mA. max. 30.8 watts
Power Pin Assignment	1/2(+), 3/6(-)
PoE Power Budget	240 watts max. @25 degrees C 200 watts max. @50 degrees C
Number of PDs, 7 watts	8 units
Number of PDs, 15.4 watts	8 units
Number of PDs, 30 watts	8 units
PoE Management	
Active POE Device Alive Detection	Yes
PoE Power Recycling	Yes, daily or predefined schedule
PoE Schedule	4 schedule profiles
PoE System Management	System PoE admin control PoE Management Mode options Over-temperature threshold alarm PoE usage threshold alarm
Layer 3 Functions	
IP Interface	Max. 8 VLAN interfaces
Routing Table	Max. 32 routing entries
Routing Protocols	IPv4 software static routing IPv6 software static routing
Layer 2 Functions	
Port Configuration	Port disable/enable Auto-negotiation 10/100/1000Mbps full and half duplex mode selection Flow Control disable/enable
Port Status	Display each port's speed duplex mode, link status, flow control status, auto negotiation status, trunk status
Port Mirroring	TX/RX/Both Many-to-1 monitor

Port Backup	4 groups with Active/Backup port assign
VLAN	802.1Q tag-based VLAN Q-in-Q tunneling Private VLAN Edge (PVE) MAC-based VLAN Protocol-based VLAN VLAN Translation Voice VLAN MVR (Multicast VLAN Registration) GVRP Up to 4K VLAN groups, out of 4095 VLAN IDs
Link Aggregation	IEEE 802.3ad LACP/static trunk Supports 6 trunks groups with 12 ports per trunk group
Spanning Tree Protocol	IEEE 802.1D Spanning Tree Protocol IEEE 802.1w Rapid Spanning Tree Protocol IEEE 802.1s Multiple Spanning Tree Protocol
QoS	Traffic classification based, strict priority and WRR 8-Level priority for switching - Port Number - 802.1p priority - 802.1Q VLAN tag - DSCP/TOS field in IP packet
IGMP Snooping	IPv4 IGMP Snooping (v1/v2/v3) IPv4 IGMP Querier mode support Up to 255 multicast groups
MLD Snooping	IPv6 MLD Snooping ((v1/v2) IPv6 MLD Querier mode support Up to 255 multicast groups
Bandwidth Control	Per port bandwidth control Ingress: 10Kbps~3276Mbps Egress: 10Kbps~3276Mbps
Security Functions	
Access Control List	IP-based ACL/MAC-based ACL ACL based on: - MAC Address - IP Address - Ethertype - Protocol Type - VLAN ID - DSCP - 802.1p Priority Up to 256 entries
Security	Port security IP source guard Dynamic ARP inspection Command line authority control based on user level
AAA	RADIUS client TACACS+ client
Network Access Control	IEEE 802.1x port-based network access control MAC-based authentication Local/RADIUS authentication
Management Functions	
Basic Management Interfaces	Console; Telnet; Web Browser; SNMP v1, v2c
Secure Management Interfaces	SSHv2, TLSv1.2, SNMPv3
System Management	Firmware upgrade by HTTP protocol through Ethernet network Configuration upload/download through HTTP Remote Syslog System log LLDP protocol NTP PLANET Smart Discovery Utility

Event Management	Remote Syslog Local System log SMTP
ONVIF	ONVIF device discovery ONVIF device monitoring Floor Map
SNMP MIBs	RFC 1213 MIB-II RFC 2863 IF-MIB RFC 1493 Bridge MIB RFC 1643 Ethernet MIB RFC 2863 Interface MIB RFC 2665 Ether-Like MIB RFC 2737 Entity MIB RFC 2819 RMON MIB (Groups 1, 2, 3 and 9) RFC 2618 RADIUS Client MIB RFC 3411 SNMP-Frameworks-MIB IEEE 802.1X PAE LLDP MAU-MIB Power over Ethernet MIB
Standards Conformance	
Regulatory Compliance	FCC Part 15 Class A, CE
Standards Compliance	IEEE 802.3 10BASE-T IEEE 802.3u 100BASE-TX/100BASE-FX IEEE 802.3z 1000BASE-SX/LX IEEE 802.3ab 1000BASE-T IEEE 802.3x flow control and back pressure IEEE 802.3ad port trunk with LACP IEEE 802.1D Spanning Tree protocol IEEE 802.1w Rapid Spanning Tree protocol IEEE 802.1s Multiple Spanning Tree protocol IEEE 802.1p Class of service IEEE 802.1Q VLAN tagging IEEE 802.1x Port Authentication Network Control IEEE 802.1ab LLDP IEEE 802.3af Power over Ethernet IEEE 802.3at Power over Ethernet PLUS RFC 768 UDP RFC 793 TFTP RFC 791 IP RFC 792 ICMP RFC 2068 HTTP RFC 1112 IGMP version 1 RFC 2236 IGMP version 2 RFC 3376 IGMP version 3 RFC 2710 MLD version 1 RFC 3810 MLD version 2
Environment	
Operating	Temperature: 0 ~ 50 degrees C Relative Humidity: 5 ~ 95% (non-condensing)
Storage	Temperature: -10 ~ 70 degrees C Relative Humidity: 5 ~ 95% (non-condensing)

Ordering Information

GS-5220-8P2T2S

L2+ 8-Port 10/100/1000T 802.3at PoE + 2-Port 10/100/1000T + 2-Port 100/1000X SFP Managed Switch

Related PoE Products

WGSW-24040HP4	L2+ 24-Port 10/100/1000Mbps 802.3at PoE+ Managed Switch with 4 Shared SFP Ports (440 watts)
WGSW-20160HP	L2+ 16-Port 10/100/1000BASE-T 802.3at PoE + 4G TP/SFP Combo Managed Switch
POE-161S	IEEE 802.3at Gigabit Power over Ethernet Plus Splitter with 5V/12VDC output (10/100/1000Mbps)
POE-162S	IEEE 802.3at Gigabit Power over Ethernet Plus Splitter with 12V/24VDC output (10/100/1000Mbps)
IPOE-162S	Industrial IEEE 802.3at Gigabit High Power over Ethernet Splitter
POE-E201	IEEE 802.3at Power over Gigabit Ethernet Extender
POE-E202	1-Port 802.3at PoE+ to 2-port 802.3af/at Gigabit PoE Extender

Available 1000Mbps Modules

Gigabit Ethernet Transceiver (1000BASE-X SFP)

Model	DDM	Speed (Mbps)	Connector Interface	Fiber Mode	Distance	Wavelength (nm)	Operating Temp.
MGB-GT	--	1000	Copper	--	100m	--	0 ~ 60 degrees C
MGB-SX(V2)	YES	1000	LC	Multi Mode	550m	850nm	0 ~ 60 degrees C
MGB-SX2(V2)	YES	1000	LC	Multi Mode	2km	1310nm	0 ~ 60 degrees C
MGB-LX(V2)	YES	1000	LC	Single Mode	20km	1310nm	0 ~ 60 degrees C
MGB-L40	YES	1000	LC	Single Mode	40km	1310nm	0 ~ 60 degrees C
MGB-L80	YES	1000	LC	Single Mode	80km	1550nm	0 ~ 60 degrees C
MGB-L120(V2)	YES	1000	LC	Single Mode	120km	1550nm	0 ~ 60 degrees C

Gigabit Ethernet Transceiver (1000BASE-BX, Single Fiber Bi-directional SFP)

Model	DDM	Speed (Mbps)	Connector Interface	Fiber Mode	Distance	Wavelength (TX)	Wavelength (RX)	Operating Temp.
MGB-LA10(V2)	YES	1000	WDM(LC)	Single Mode	10km	1310nm	1550nm	0 ~ 60 degrees C
MGB-LB10(V2)		1000	WDM(LC)	Single Mode	10km	1550nm	1310nm	0 ~ 60 degrees C
MGB-LA20(V2)	YES	1000	WDM(LC)	Single Mode	20km	1310nm	1550nm	0 ~ 60 degrees C
MGB-LB20(V2)		1000	WDM(LC)	Single Mode	20km	1550nm	1310nm	0 ~ 60 degrees C
MGB-LA40(V2)	YES	1000	WDM(LC)	Single Mode	40km	1310nm	1550nm	0 ~ 60 degrees C
MGB-LB40(V2)		1000	WDM(LC)	Single Mode	40km	1550nm	1310nm	0 ~ 60 degrees C
MGB-LA80	YES	1000	WDM(LC)	Single Mode	80km	1490nm	1550nm	0 ~ 60 degrees C
MGB-LB80		1000	WDM(LC)	Single Mode	80km	1550nm	1490nm	0 ~ 60 degrees C

Available 100Mbps Modules

Fast Ethernet Transceiver (100BASE-X SFP)

Model	Speed (Mbps)	Connector Interface	Fiber Mode	Distance	Wavelength (nm)	Operating Temp.	Operating Temp.
MFB-FX	100	LC	Multi Mode	2km	1310nm	0 ~ 60 degrees C	0 ~ 60 degrees C
MFB-F20	100	LC	Single Mode	20km	1310nm	0 ~ 60 degrees C	0 ~ 60 degrees C
MFB-F40	100	LC	Single Mode	40km	1310nm	0 ~ 60 degrees C	0 ~ 60 degrees C
MFB-F60	100	LC	Single Mode	60km	1310nm	0 ~ 60 degrees C	-40 ~ 75 degrees C
MFB-F120	100	LC	Single Mode	120km	1310nm	0 ~ 60 degrees C	-40 ~ 75 degrees C

Fast Ethernet Transceiver (100BASE-BX, Single Fiber Bi-directional SFP)

Model	Speed (Mbps)	Connector Interface	Fiber Mode	Distance	Wavelength (TX)	Wavelength (RX)	Operating Temp.
MFB-FA20	100	WDM(LC)	Single Mode	20km	1310nm	1550nm	0 ~ 60 degrees C
MFB-FB20	100	WDM(LC)	Single Mode	20km	1550nm	1310nm	0 ~ 60 degrees C