



**QUICK
REFERENCE
GUIDE**



“Connecting the World of Hydraulics”

Set up your online account!



Log in to www.omindustrial.com

Online Account Benefits:

- Place online orders with your current payment terms
- Search (live) inventory for all locations
- View drawings and photos of parts
- View current prices

CREATE ACCOUNT

User Name:

Remember Me

Password:

Sign Up

Table of Contents

Parts Nomenclature / Glossary	3
Thread Charts	4
Brass Adapters & Fittings	5-6
• JIC Adapters	
• Pipe Adapters	
• Compression Adapters	
• SAE 45° Flare Adapters	
• Hose Barb Fittings	
• Push-On Hose Barb Fittings	
• D.O.T. Airbrake Fittings	
• Push to Connect D.O.T. Fittings	
Carbon Steel Tube Fittings & Adapters	7-15
• Tube Fittings & Adapters	
• Flange Adapters & Accessories	
• O-Ring Face Seal Fittings	
• Test Gauge Fittings	
• Compression Fittings (Flareless Bite Type)	
• Braze Fittings & Beaded Hose Adapters	
Live Swivels	15
International Adapters & Fittings	16-18
• Conversion Adapters	
• DIN Metric Bite Type Fittings	
Stainless Steel Adapters, Fittings, & Tubing	19-22
• Tube Fittings & Adapters	
• Conversion Adapters (International Threads)	
• Tubing	
• Instrumentation Fittings (Single & Double Ferrule)	
Kits & Accessories	23
• Cap & Plug Kits	
• O-Ring Kits	
Hose	24-25
• Hydraulic Hose	
• Industrial Hose	
Hose Crimp Fittings	26
• HY Series	
• 43 Series	
• BW Series	
• 73 Series	

Parts Nomenclature

Sample Part Number

FS6801-L-04-04-NWO-FG



Prefix Options:

C: Bite Type (Compression)
 DM: Din Metric
 FS: Face Seal
 SS: Stainless Steel
 SS-C: SS Compression
 SS-IN: SS Instrumentation
 TGT: Test Gauge Tee
 B: Brass
 B-C: Brass Compression
 B-F: Brass SAE 45° Flare
 B-HB: Brass Hose Barb
 B-PO: Brass Push-On



Series Options:

C: Cap
 HHP: Hollow Hex Plug
 LH: Large Hex
 L: Light (Metric)
 L: Long
 LL: Extra Long
 LLL: Extra Extra Long
 LN: Bulkhead Lock Nut
 P: Plug
 S: Heavy (Metric)
 SHP: Square Head Plug
 TS: Tube Spud



Part Options:

ASY: Assembly
 FG: Forged Flats of Hex
 NWO: Nut Washer O-Ring
 O: O-Ring
 Tube: One Piece Swept Style
 BS: Bar Stock

FS6801-L

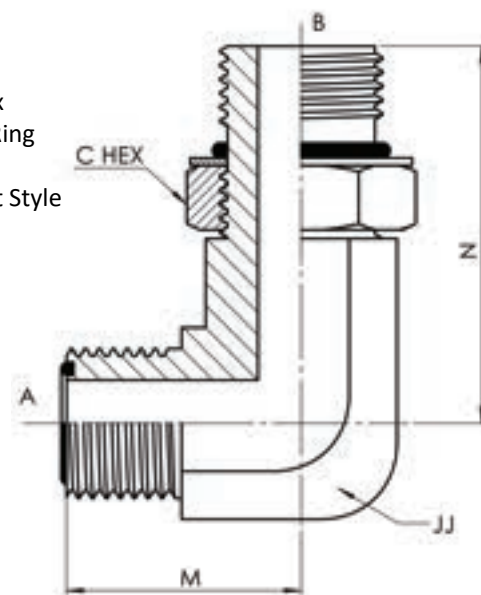

- The standard product is produced in carbon steel and requires no prefix
- Sizes are measured in sixteenths of an inch
- Metric Bite Type fittings are ordered by tube size in millimeters
- Metric Port fittings are ordered by thread O.D. and thread pitch in millimeters
- BSPP fittings are British, but still measured fractionally in sixteenths of an inch

Glossary

ABN: Air Brake for Nylon Tubing
 BT: Bite Type
 CL: Close Nipple
 D.O.T.: Department of Transportation
 FBSPP: Female British Standard Pipe Parallel
 FBSPPS: Female British Standard Pipe Parallel Swivel
 FFS: Female Face Seal
 FFSS: Female Face Seal Swivel
 FJ: Female JIC
 FJS: Female JIC Swivel
 FJIS: Female JIS (Japanese Industrial Standard)
 FK: Female Komatsu
 FM: Female Metric
 FMA: Female Metric Adjustable
 FORB: Female O-Ring Boss
 FP: Female Pipe
 FPS: Female Pipe Swivel
 HB: Hose Barb
 JIC: Joint Industrial Council, 37° Flare
 JIS: Japanese Industrial Standard
 LS: Live Swivel
 MAORB: Male Adjustable O-Ring Boss
 MBT: Metric Bite Type
 MBSPP: Male British Standard Pipe Parallel
 MBSPPA: Male British Standard Pipe Parallel Adjustable

MBSPPAORB: Male British Standard Pipe Parallel Adjustable O-Ring Boss
 MBSPT: Male British Standard Pipe Tapered
 MFS: Male Face Seal
 MJ: Male JIC
 MJIS: Male JIS (Japanese Industrial Standard)
 MK: Male Komatsu
 MM: Male Metric
 MMA: Male Metric Adjustable
 MMAORB: Male Metric Adjustable O-Ring Boss
 MMBSP: Male Metric British Standard Pipe Parallel
 MMORB: Male Metric O-Ring Boss
 MMT: Male Metric Tapered
 MORB: Male O-Ring Boss
 MP: Male Pipe
 MPS: Male Pipe Swivel
 N: Nipple
 PC: Push to Connect
 PO: Peflex O-Ring
 POHB: Push-On Hose Barb
 SAE: Society of Automotive Engineering
 SHP: Square Head Plug
 SLD: Solid
 SSL: Stainless Steel Live Swivel

Thread Charts (Metric and International)











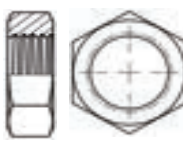



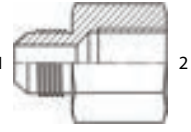

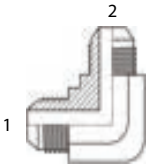
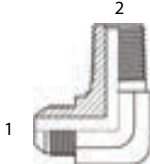
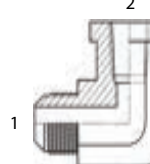
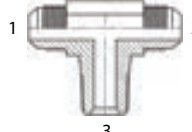





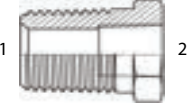

JIC - SAE - Metric

Dash Size	2	3	4	5	6	8	10	12	14	16	20	24	32	40	48
Tube O.D.	1/8	3/16	1/4	5/16	3/8	1/2	5/8	3/4	7/8	1	1¼	1½	2	2½	3
Hose I.D.	1/8	3/16	1/4	5/16	3/8	1/2	5/8	3/4		1	1¼	1½	2	2½	3
JIC 37-Flare Thread	5/16-24	3/8-24	7/16-20	1/2-20	9/16-18	3/4-16	7/8-14	1½-12	1¾-12	1¾-12	1¾-12	1¾-12	2½-12	3-12	3½-12
SAE O-Ring Thread	5/16-24	3/8-24	7/16-20	1/2-20	9/16-18	3/4-16	7/8-14	1½-12	1¾-12	1¾-12	1¾-12	1¾-12	2½-12		
NPTF Pipe Thread	1/8-27		1/4-18		3/8-18	1/2-14		3/4-14		1-11½	1¼-11½	1½-11½	2-11½	2½-8	3-8
NPSM Swivel Thread	1/8-27		1/4-18		3/8-18	1/2-14		3/4-14		1-11½	1¼-11½	1½-11½	2-11½		
Face Seal Thread			9/16-18		11/16-16	13/16-16	1-14	13/18-12		1¾-12	11¾-12	2-12			
Code 61 Flange Head O.D.						1.19		1.50		1.75	2.00	2.38	2.81	3.31	4.00
Code 62 Flange Head O.D.						1.25		1.62		1.88	2.12	2.50	3.12		
British Thread BSP/BSPT	1/8-28		1/4-19		3/8-19	1/2-14		3/4-14		1-11	1¼-11	1½-11			
Compression Thread	5/16-24	3/8-24	7/16-20	1/2-20	9/16-18	3/4-16	7/8-14	1½-12	1¾-12	1¾-12	1¾-12	1¾-12	2½-12		
Metric Thread	10	12	14	16	18	20	22	24	26	27	30	33	36	42	48
	M10x1.0	M12x1.5	M14x1.5	M16x1.5	M18x1.5	M20x1.5	M22x1.5	M24x1.5t	M26x1.5	M27x2.0	M30x2.0	M33x2.0	M36x2.0	M42x2.0	M48x2.0

Metric Threads (Light & Heavy)

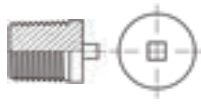
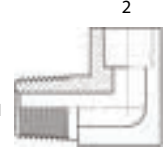
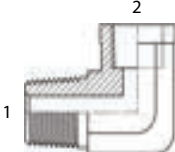
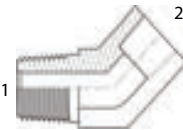

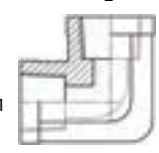
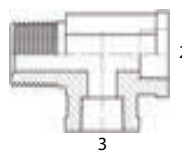
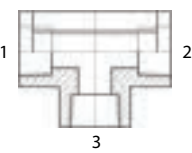
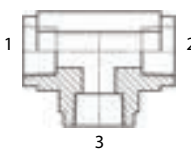











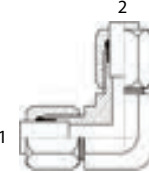
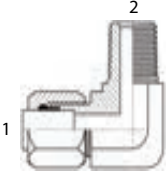
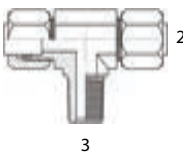
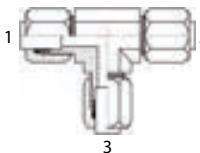



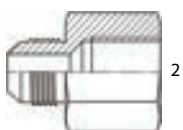



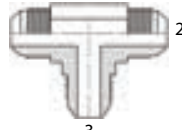

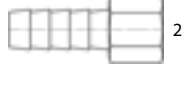
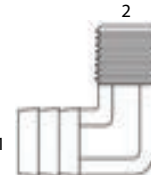
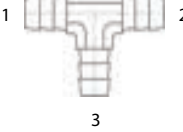
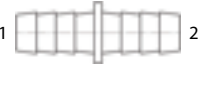

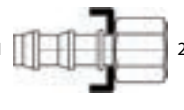
Tube Size - Light	Thread Size	Tube Size - Heavy	Thread Size
06L	M 12 x 1.5	06S	M 14 x 1.5
08L	M 14 x 1.5	08S	M 16 x 1.5
10L	M 16 x 1.5	10S	M 18 x 1.5
12L	M 18 x 1.5	12S	M 20 x 1.5
15L	M 22 x 1.5	14S	M 22 x 1.5
18L	M 26 x 1.5	16S	M 24 x 1.5
22L	M 30 x 2.0	20S	M 30 x 2.0
28L	M 36 x 2.0	25S	M 36 x 2.0
35L	M 45 x 2.0	30S	M 42 x 2.0
42L	M 52 x 2.0	38S	M 52 x 2.0

Brass Adapters & Fittings

 B-0304-C JIC Cap Nut	 B-0306 Bulkhead Locknut	 B-0318 JIC Tube Nut	 B-0319 JIC Tube Sleeve	 B-2403 MJ-MJ Straight	 B-2404 MJ-MP Straight
 B-2405 MJ-FP Straight	 B-2408 MJ Plug	 B-2500-FG MJ-MJ 90° Elbow	 B-2501-FG MJ-MP 90° Elbow	 B-2502-FG MJ-FP 90° Elbow	 B-2601-FG MJ-MJ-MP Tee
 B-2602-FG MJ-MJ-FP Tee	 B-2603-FG MJ-MJ-MJ Tee	 B-2700 MJ-MJ Bulkhead Straight	 B-2701-FG MJ-MJ Bulkhead 90° Elbow	 B-5000 FP-FP Straight	 B-5404 MP-MP Hex Straight
 B-5404-CL MP Close Nipple	 B-5404-N MP-MP Long Nipple	 B-5405 MP-FP Straight Expander	 B-5406 MP-FP Straight Bushing	 B-5406-C Pipe Cap	 B-5406-HHP Hollow Hex Pipe Plug
 B-5406-P External Hex Pipe Plug	 B-5406-SHP Square Head Pipe Plug (Hollow/Solid)	 B-5502-BS MP-FP 90° Street Elbow Bar Stock	 B-5502-FG MP-FP 90° Street Elbow	 B-5503-BS MP-FP 45° Street Elbow Bar Stock	 B-5503-FG MP-FP 45° Street Elbow
 B-5504-BS FP-FP 90° Elbow Bar Stock	 B-5504-FG FP-FP 90° Elbow	 B-5602-FG MP-FP-FP Tee	 B-5605-BS FP-FP-FP Tee Bar Stock	 B-5605-FG FP-FP-FP Tee	 B-C0318 Compression Nut



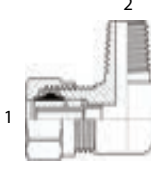

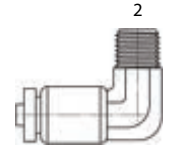
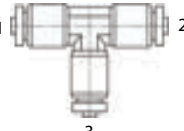





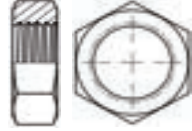

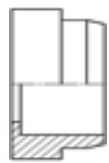
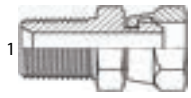
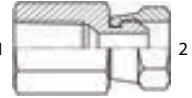
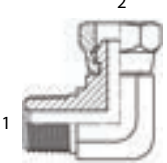
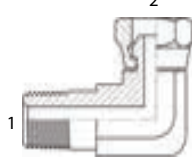
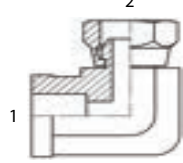

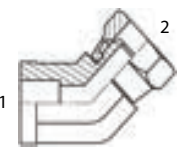
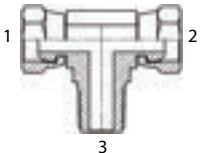
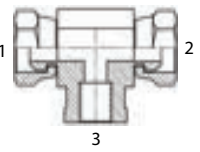
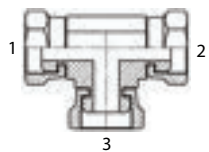
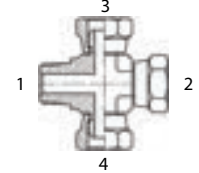
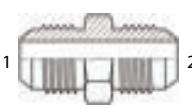
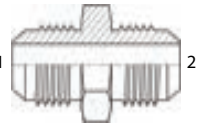
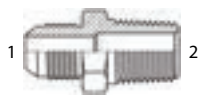
** All brass airbrake push to connect and nylon tube fittings meet D.O.T. FMVSS71.106 performance, as well as functional requirements J246 & SAE J1131. They are designed for all D.O.T. truck and trailer applications. **

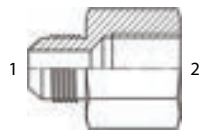
Brass Adapters & Fittings

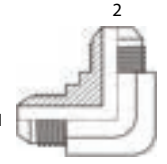
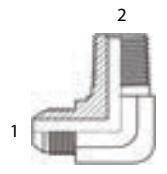
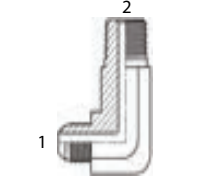
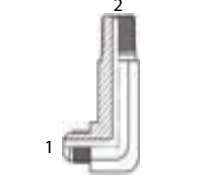

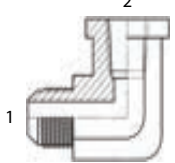
 B-C0319 Compression Sleeve	 B-C2403 BT-BT Straight	 B-C2404 BT-MP Straight	 B-C2405 BT-FP Straight	 B-C2500-FG BT-BT 90° Elbow	 B-C2501-FG BT-MP 90° Elbow
 B-C2601-FG BT-BT-MP Tee	 B-C2603-FG BT-BT-BT Tee	 B-F0302 Flare Short Nut	 B-F0304 Flare Standard Nut	 B-F2403 MF-MF Straight	 B-F2404 MF-MP Straight
 B-F2405 MF-FP Straight	 B-F2408 MF Plug	 B-F2500-FG MF-MF 90° Elbow	 B-F2501-FG MF-MP 90° Elbow	 B-F2603-FG MF-MF-MF Tee	 B-HB3102 HB-MP Straight
 B-HB3104 HB-FP Straight	 B-HB3109-FG HB-MP 90° Elbow	 B-HB3133-FG HB-HB-HB Tee	 B-HB3178 HB-HB Splicer	 B-PO2272 POHB-MP Straight	 B-PO2274 POHB-FP Straight
 B-PO2287 POHB-Female Dual Seat Swivel-37°/45°	 B-PO2294 POHB-Tube	 B-PO2296 POHB-POHB	 B-ABN0318 Air Brake Nylon Nut D.O.T.	 B-ABN0319 Air Brake Nylon Sleeve D.O.T.	 B-ABN2403 ABN-ABN Straight D.O.T.
 B-ABN2404 ABN-MP Straight D.O.T.	 B-ABN2501-BS ABN-MP 90° Elbow D.O.T.	 B-PC2403 PC-PC Straight D.O.T.	 B-PC2404 PC-MP Straight D.O.T.	 B-PC2501-FG PC-MP 90° Elbow D.O.T.	 B-PC2603-FG PC-PC-PC Tee D.O.T.

** All brass airbrake push to connect and nylon tube fittings meet D.O.T. FMVSS71.106 performance, as well as functional requirements J246 & SAE J1131. They are designed for all D.O.T. truck and trailer applications. **

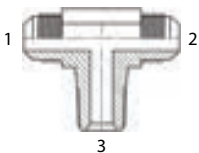
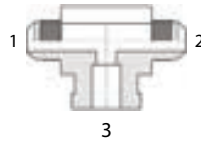
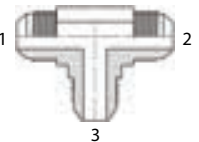
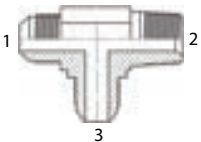

Carbon Steel Tube Fittings & Adapters

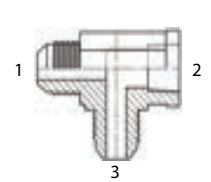
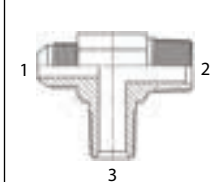
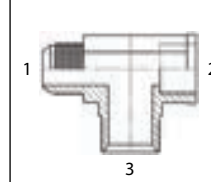
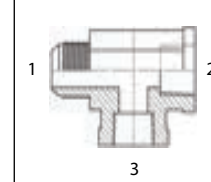
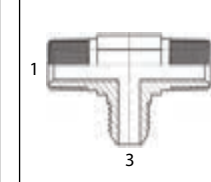
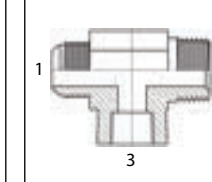
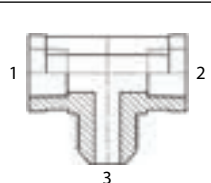
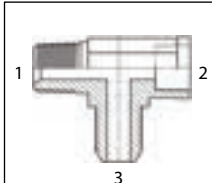
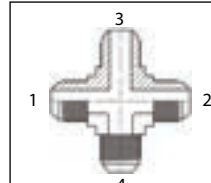
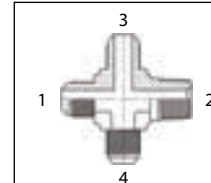
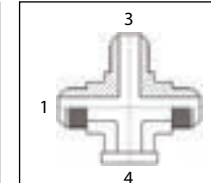
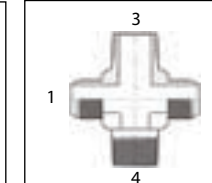
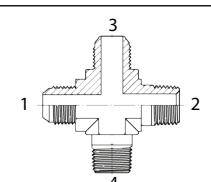
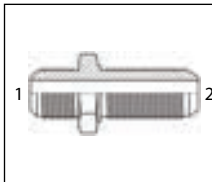
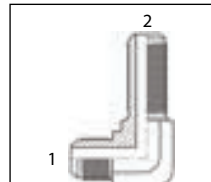
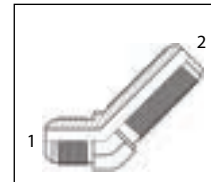
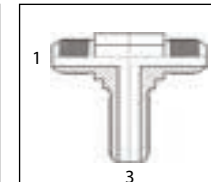
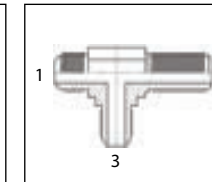
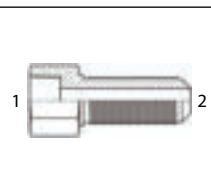
 0304-C JIC Cap Nut	 0306 Bulkhead Locknut	 0318 JIC Tube Nut	 0319 JIC Tube Sleeve	 1404 MP-FPS Straight	 1405 FP-FPS Straight
 1501-FG MP-FPS 90° Elbow	 1501-L-FG MP-FPS 90° Elbow Long	 1502-FG FP-FPS 90° Elbow	 1503-FG MP-FPS 45° Elbow	 1504-FG FP-FPS 45° Elbow	 1601-FG FPS-FPS-MP Tee
 1602-FG FPS-FPS-FP Tee	 1603-FG FPS-FPS-FPS Tee	 1604-FG MP-FPS-FPS-FPS Cross	 2403 MJ-MJ Straight	 2403-LH MJ-MJ Straight Large Hex	 2404 MJ-MP Straight
 2404-L MJ-MP Straight Long	 2404-LL MJ-MP Straight X-Long	 2405 MJ-FP Straight	 2406 FJ-MJ Straight Reducer	 2408 MJ Plug	 2500-FG MJ-MJ 90° Elbow
 2501-FG MJ-MP 90° Elbow	 2501-L-FG MJ-MP 90° Elbow Long	 2501-LL-FG MJ-MP 90° Elbow X-Long	 2501-LLL-FG MJ-MP 90° Elbow XX-Long	 2502-FG MJ-FP 90° Elbow	 2503-FG MJ-MP 45° Elbow
 2504-FG MJ-MJ 45° Elbow	 2505-FG MJ-FP 45° Elbow	 2601-FG MJ-MJ-MP Tee	 2602-FG MJ-MJ-FP Tee	 2603-FG MJ-MJ-MJ Tee	 2605-FG MJ-MP-MJ Tee

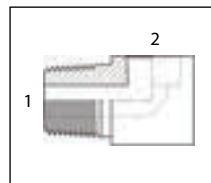
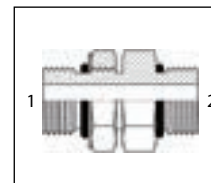
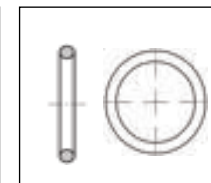
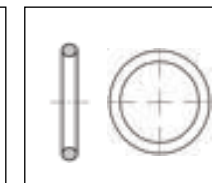
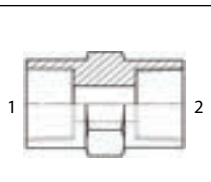
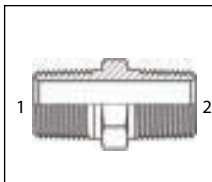
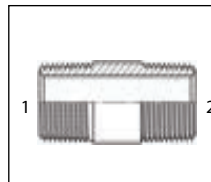
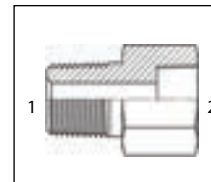
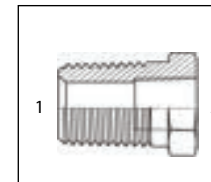
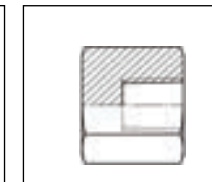
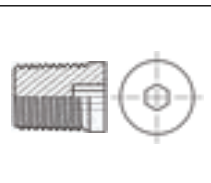
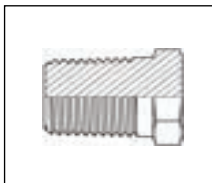
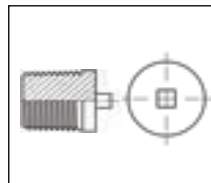
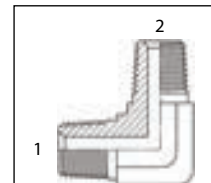
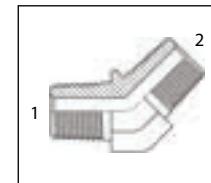
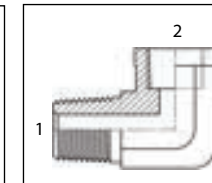



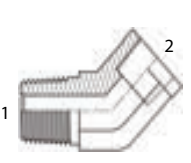
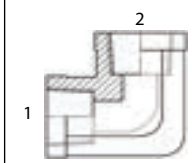
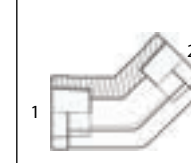
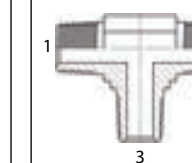
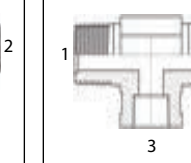
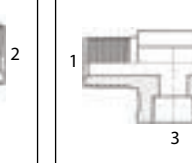
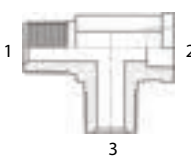
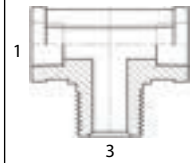
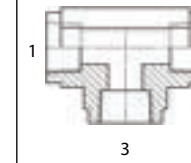
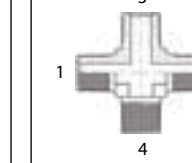
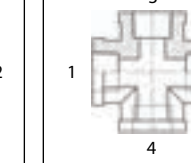
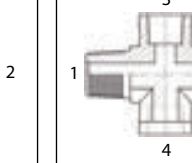
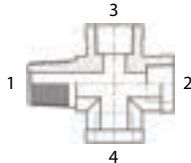
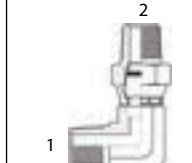
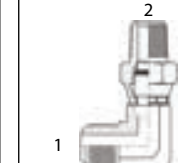
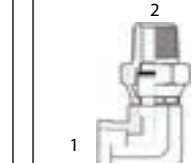
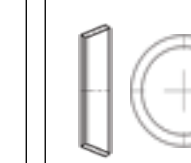
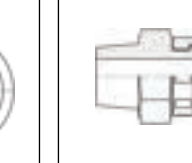
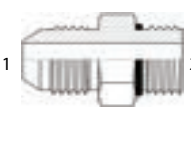
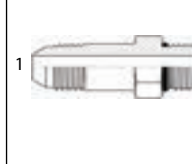
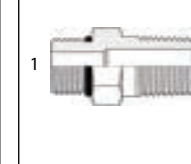
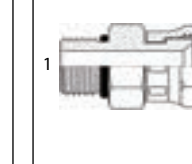
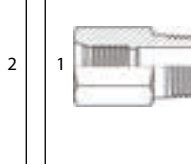
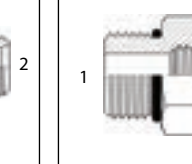

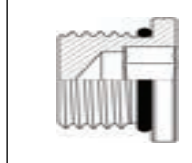
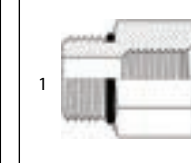
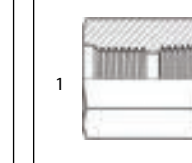
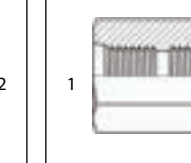
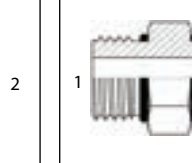
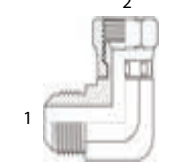
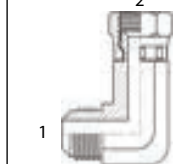
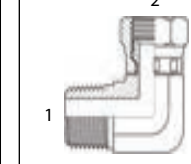
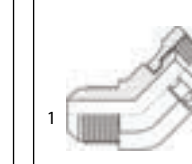
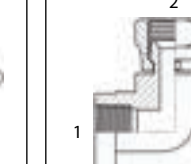
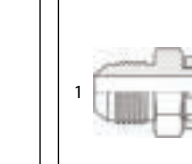



Carbon Steel Tube Fittings & Adapters

 <p>2606-FG MJ-FP-MJ Tee</p>	 <p>2607-FG MJ-MP-MP Tee</p>	 <p>2608-FG MJ-FP-MP Tee</p>	 <p>2609-FG MJ-FP-FP Tee</p>	 <p>2610-FG MP-MP-MJ Tee</p>	 <p>2611-FG MJ-MP-FP Tee</p>
 <p>2612-FG FP-FP-MJ Tee</p>	 <p>2613-FG MP-FP-MJ Tee</p>	 <p>2650-FG MJ-MJ-MJ-MJ Cross</p>	 <p>2651-FG MJ-MP-MJ-MJ Cross</p>	 <p>2652-FG MJ-MJ-MJ-FP Cross</p>	 <p>2653-FG MJ-MJ-MP-MP Cross</p>
 <p>2654-FG MJ-MP-MJ-MP Cross</p>	 <p>2700 MJ-MJ Bulkhead Straight</p>	 <p>2701-FG MJ-MJ Bulkhead 90° Elbow</p>	 <p>2702-FG MJ-MJ Bulkhead 45° Elbow</p>	 <p>2703-FG MJ-MJ-MJ Blkhd Branch Tee</p>	 <p>2704-FG MJ-MJ-MJ Bulkhead Run Tee</p>
 <p>2705 FP-MJ Bulkhead Straight</p>	 <p>2706 MP-MJ Bulkhead Straight</p>	 <p>3051 MP-FP Low Profile 90° Elbow</p>	 <p>3474-NWO MAORB-MORB Straight</p>	 <p>4000 Buna O-Ring (Boss Threads)</p>	 <p>4001 Viton O-Ring (Boss Threads)</p>
 <p>5000 FP-FP Straight</p>	 <p>5404 MP-MP Hex Nipple</p>	 <p>5404-N MP-MP Straight Nipple Long</p>	 <p>5405 MP-FP Straight Expander</p>	 <p>5406 MP-FP Reducer Bushing</p>	 <p>5406-C Pipe Cap</p>
 <p>5406-HHP Hollow Hex Pipe Plug</p>	 <p>5406-P External Hex Pipe Plug</p>	 <p>5406-SHP Square Head Pipe Plug</p>	 <p>5500-FG MP-MP 90° Elbow</p>	 <p>5501-FG MP-MP 45° Elbow</p>	 <p>5502-FG MP-FP 90° Street Elbow</p>

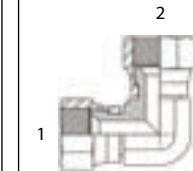
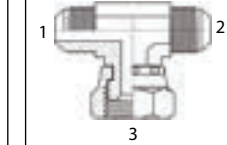
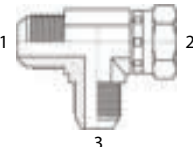
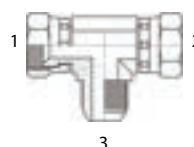
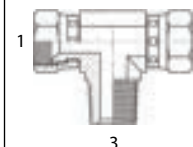
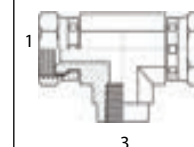
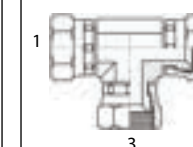
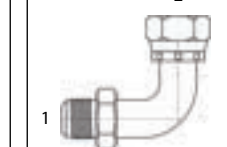
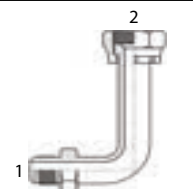
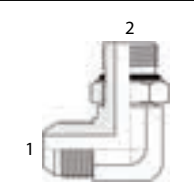
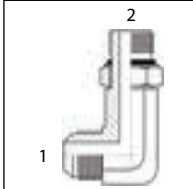
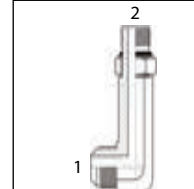
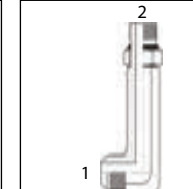
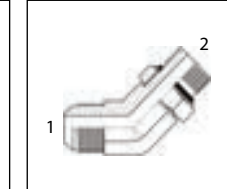
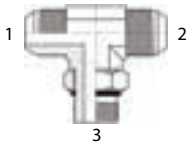
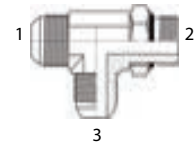
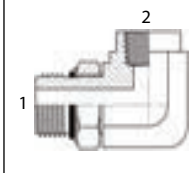
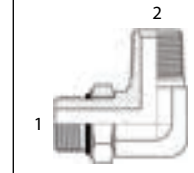
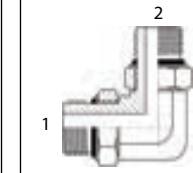
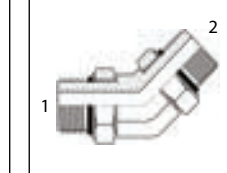
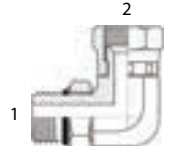

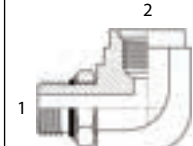
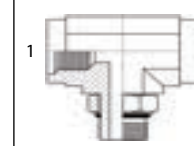
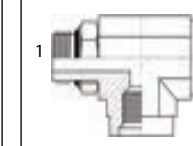
Carbon Steel Tube Fittings & Adapters

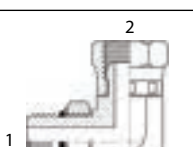
 <p>5503-FG MP-FP 45° Elbow</p>	 <p>5504-FG FP-FP 90° Elbow</p>	 <p>5505-FG FP-FP 45° Elbow</p>	 <p>5600-FG MP-MP-MP Tee</p>	 <p>5601-FG MP-MP-FP Tee</p>	 <p>5602-FG MP-FP-FP Tee</p>
 <p>5603-FG MP-FP-MP Tee</p>	 <p>5604-FG FP-FP-MP Tee</p>	 <p>5605-FG FP-FP-FP Tee</p>	 <p>5650-FG MP-MP-MP-MP Cross</p>	 <p>5652-FG FP-FP-FP-FP Cross</p>	 <p>5653-FG MP-MP-FP-FP Cross</p>
 <p>5655-FG MP-FP-FP-FP Cross</p>	 <p>5700-FG MP-MPS 90° Elbow</p>	 <p>5701-FG MJ-MPS 90° Elbow</p>	 <p>5702-FG FP-MPS 90° Elbow</p>	 <p>6000 Back-Up Washer</p>	 <p>6316 FJS Butt Weld</p>
 <p>6400-O MJ-MORB Straight</p>	 <p>6400-L-O MJ-MORB Straight Long</p>	 <p>6401-O MORB-MP Straight</p>	 <p>6402-O MORB-FJS Straight</p>	 <p>6404 FORB-MP Straight</p>	 <p>6405-O MORB-FP Straight</p>
 <p>6408-O MORB External Hex Plug</p>	 <p>6408-HHP-O MORB Hollow Hex Plug</p>	 <p>6410-O MORB-FORB Straight Reducer</p>	 <p>6420 FORB-FP Straight</p>	 <p>6425 FORB-FORB Straight</p>	 <p>6464-O MORB-MORB Straight</p>
 <p>6500-FG MJ-FJS 90° Elbow</p>	 <p>6500-L-FG MJ-FJS 90° Elbow Long</p>	 <p>6501-FG MP-FJS 90° Elbow</p>	 <p>6502-FG MJ-FJS 45° Elbow</p>	 <p>6503-FG FP-FJS 90° Elbow</p>	 <p>6504 MJ-FJS Straight</p>





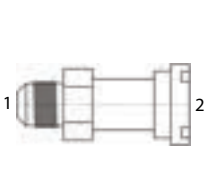
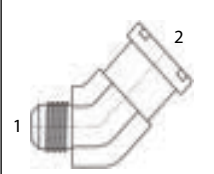
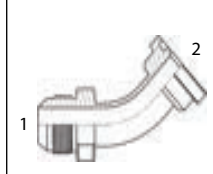
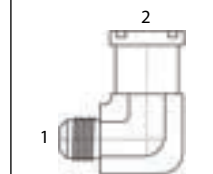
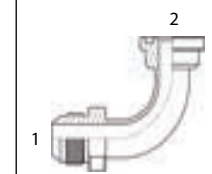
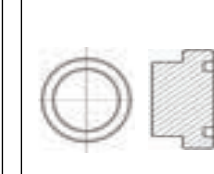
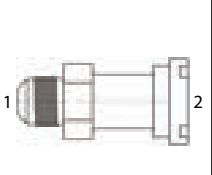
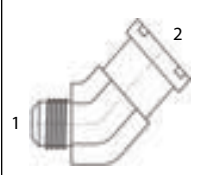
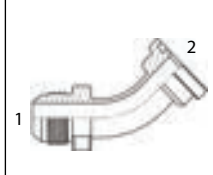
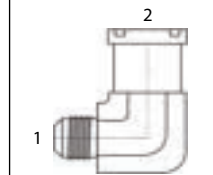
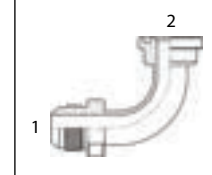
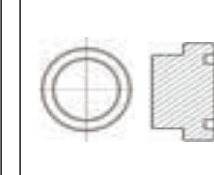

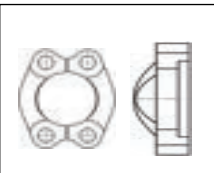
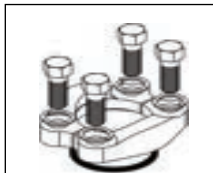
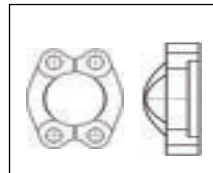
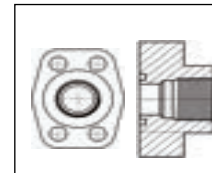
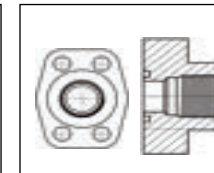
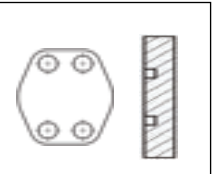
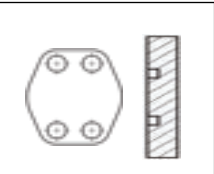
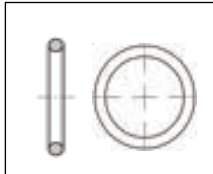



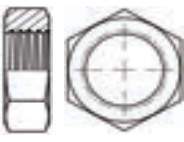

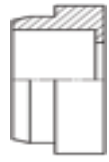
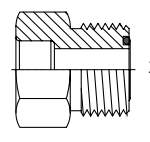
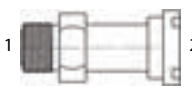
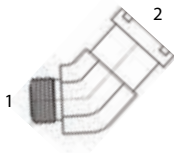
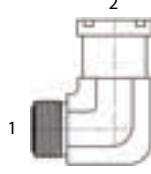
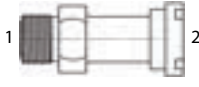
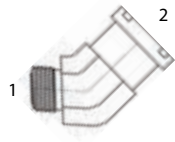
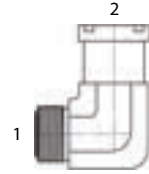

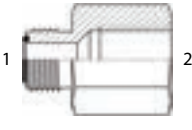

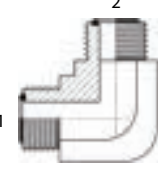
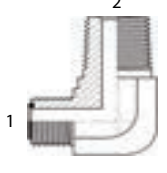
Carbon Steel Tube Fittings & Adapters

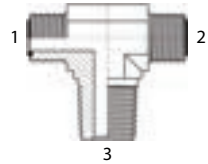
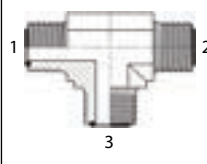
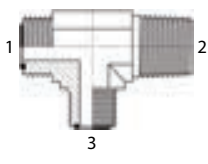
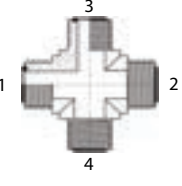
 <p>6505 MP-FJS Straight</p>	 <p>6506 FP-FJS Straight</p>	 <p>6507-FG FP-FJS 45° Elbow</p>	 <p>6565 FJS-FJS Straight</p>	 <p>6566-FG FJS-FJS 90° Elbow Forged</p>	 <p>6600-FG MJ-MJ-FJS Tee</p>
 <p>6602-FG MJ-FJS-MJ Tee</p>	 <p>6603-FG FJS-FJS-MJ Tee</p>	 <p>6604-FG FJS-FJS-MP Tee</p>	 <p>6605-FG FJS-FJS-FP Tee</p>	 <p>6606-FG FJS-FJS-FJS Tee</p>	 <p>6701 MJ-FJS Swept 90° Elbow</p>
 <p>6701-L MJ-FJS Swept 90° Elbow Long</p>	 <p>6801-NWO-FG MJ-MAORB 90° Elbow</p>	 <p>6801-L-NWO-FG MJ-MAORB 90° Elbow Long</p>	 <p>6801-LL-NWO-FG MJ-MAORB 90° Elbow X-Long</p>	 <p>6801-LLL-NWO-FG MJ-MAORB 90° Elbow XX-Long</p>	 <p>6802-NWO-FG MJ-MAORB 45° Elbow</p>
 <p>6803-NWO-FG MJ-MJ-MAORB Tee</p>	 <p>6804-NWO-FG MJ-MAORB-MJ Tee</p>	 <p>6805-NWO-FG MAORB-FP 90° Elbow</p>	 <p>6806-NWO-FG MAORB-MP 90° Elbow</p>	 <p>6807-NWO-FG MAORB-MAORB 90° Elbow</p>	 <p>6808-NWO-FG MAORB-MAORB 45° Elbow</p>
 <p>6809-NWO-FG MAORB-FJS 90° Elbow</p>	 <p>6810-NWO-FG MAORB-FJS 45° Elbow</p>	 <p>6815-NWO-FG MAORB-FORB 90° Elbow</p>	 <p>6832-NWO-FG FORB-FORB- MAORB Tee</p>	 <p>6835-NWO-FG MAORB-FORB- FORB Tee</p>	 <p>6900-O MORB-FPS Straight</p>
 <p>6901-NWO-FG MAORB-FPS 90° Elbow</p>	 <p>6902-NWO-FG MAORB-FPS 45° Elbow</p>				

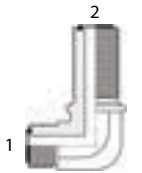

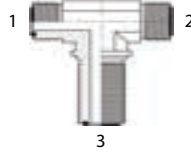
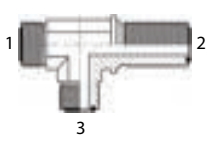
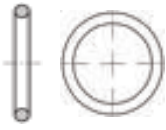
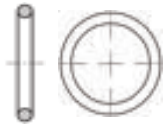



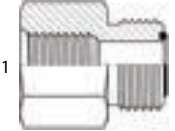
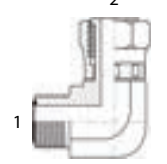



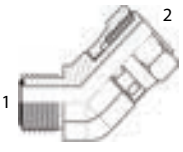

Flange Adapters & Accessories

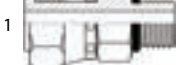
 <p>1700 MJ-Code 61 Flange Straight</p>	 <p>1703-FG MJ-Code 61 Flange Forged 45° Elbow</p>	 <p>1703-Tube MJ-Code 61 Flange Swept 45° Elbow</p>	 <p>1704-FG MJ-Code 61 Flange Forged 90° Elbow</p>	 <p>1704-Tube MJ-Code 61 Flange Swept 90° Elbow</p>	 <p>1724 O-Ring Face Code 61 Flange Plug</p>
 <p>1800 MJ-Code 62 Flange Straight</p>	 <p>1803-FG MJ-Code 62 Flange Forged 45° Elbow</p>	 <p>1803-Tube MJ-Code 62 Flange Swept 45° Elbow</p>	 <p>1804-FG MJ-Code 62 Flange Forged 90° Elbow</p>	 <p>1804-Tube MJ-Code 62 Flange Swept 90° Elbow</p>	 <p>1824 O-Ring Face Code 62 Flange Plug</p>
 <p>1901-KIT Code 61 Split Flange Kit</p>	 <p>1901-Halves Code 61 Split Flange Halves (Pair)</p>	 <p>1902-KIT Code 62 Split Flange Kit</p>	 <p>1902-Halves Code 62 Split Flange Halves (Pair)</p>	 <p>1927-61-KIT FP-Code 61 Flange Block Kit</p>	 <p>1927-62-KIT FP-Code 62 Flange Block Kit</p>
 <p>1979-61 Code 61 Flange Shipping Plate</p>	 <p>1979-62 Code 62 Flange Shipping Plate</p>	 <p>4005 Flange O-Ring</p>			

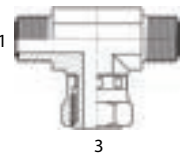
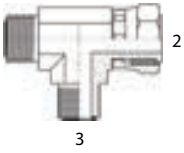
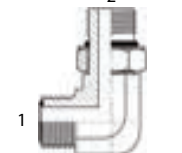
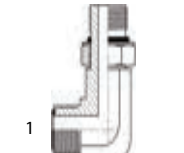
O-Ring Face Seal Fittings

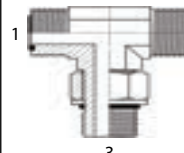
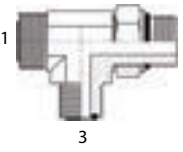
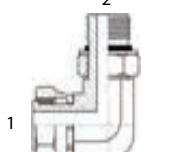
 FS0304-C-ASY Cap Assembly	 FS0306 Bulkhead Locknut	 FS0318 Nut	 FS0319 Sleeve	 FS0403 Bore-MFS Straight	 FS1700 MFS-Code 61 Flange Straight
 FS1703-FG MFS-Code 61 Flange 45° Elbow	 FS1704-FG MFS-Code 61 Flange 90° Elbow	 FS1800 MFS-Code 62 Flange Straight	 FS1803-FG MFS-Code 62 Flange 45° Elbow	 FS1804-FG MFS-Code 62 Flange 90° Elbow	 FS2403 MFS-MFS Straight
 FS2404 MFS-MP Straight	 FS2405 MFS-FP Straight	 FS2406 FFS-MFS Straight	 FS2408 MFS Plug	 FS2500-FG MFS-MFS 90° Elbow	 FS2501-FG MFS-MP 90° Elbow
 FS2503-FG MFS-MP 45° Elbow	 FS2601-FG MFS-MFS-MP Tee	 FS2603-FG MFS-MFS-MFS Tee	 FS2605-FG MFS-MP-MFS Tee	 FS2650-FG MFS-MFS-MFS- MFS Cross	 FS2700 MFS-MFS Bulkhead Straight
 FS2701-FG MFS-MFS Bulkhead 90° Elbow	 FS2702-FG MFS-MFS Bulkhead 45° Elbow	 FS2703-FG MFS-MFS-MFS Blkhd Branch Tee	 FS2704-FG MFS-MFS-MFS Bulkhead Run Tee	 FS4000 Buna O-Ring	 FS4001 Viton O-Ring
 FS6400-O MFS-MORB Straight	 FS6400-L-O MFS-MORB Straight Long	 FS6402 MFS-FJS Straight	 FS6403 MFS-MJ Straight	 FS6410 FORB-MFS Straight	 FS6500-FG MFS-FFSS 90° Elbow

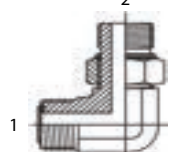
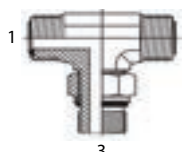
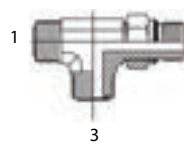





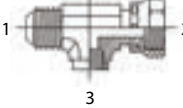
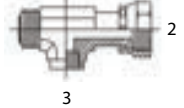



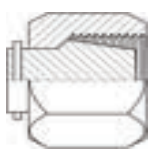
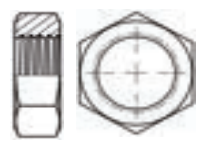







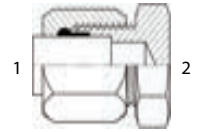
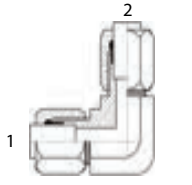
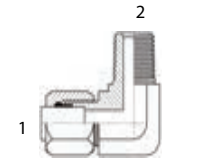
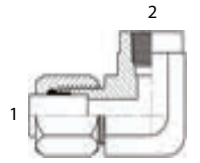

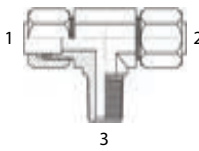
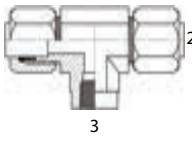
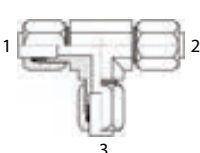
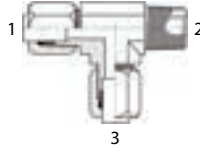
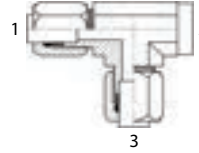
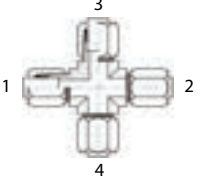
O-Ring Face Seal Fittings

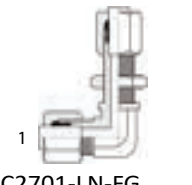
 <p>FS6502-FG MFS-FFSS 45° Elbow</p>	 <p>FS6503-FG FFS-FFSS 90° Elbow</p>	 <p>FS6504 FFS-MJ Straight</p>	 <p>FS6505 FFS-MP Straight</p>	 <p>FS6540-O FFS-MORB Straight</p>	 <p>FS6565 FFS-FFSS Straight</p>
 <p>FS6600-FG MFS-MFS-FFSS Branch Tee</p>	 <p>FS6602-FG MFS-FFSS-MFS Run Tee</p>	 <p>FS6801-NWO-FG MFS-MAORB 90° Elbow</p>	 <p>FS6801-L-NWO-FG MFS-MAORB 90° Elbow Long</p>	 <p>FS6802-NWO-FG MFS-MAORB 45° Elbow</p>	 <p>FS6803-NWO-FG MFS-MFS-MAORB Branch Tee</p>
 <p>FS6804-NWO-FG MFS-MAORB-MFS Run Tee</p>	 <p>FS6809-NWO-FG FFS-MAORB 90° Elbow</p>	 <p>FS7202-NWO-FG MFS-MBSPAORB 90° Elbow</p>	 <p>FS7205-NWO-FG MFS-MMAORB 90° Elbow</p>	 <p>FS7210-NWO-FG MFS-MFS- MMAORB Br Tee</p>	 <p>FS7215-NWO-FG MFS-MMAORB- MFS Run Tee</p>
 <p>FS7300-NWO-FG MFS-MMAORB 45° Elbow</p>	 <p>FS7640-O MFS-MMORB Straight</p>				

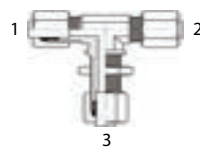
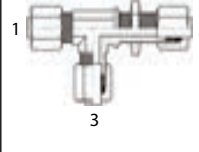
Test Gauge Fittings

 <p>TGT-6504 MJ-FJS-Pipe Port Tee</p>	 <p>TGT-FS2406 MFS-FFSS-Pipe Port Tee</p>
--	--

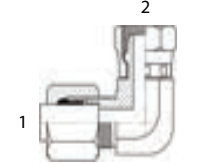
Compression Fittings (Flareless Bite Type)

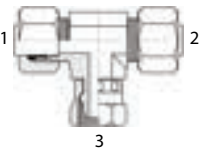
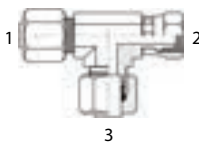
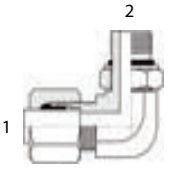
 C304-C Compression Cap Assembly	 C0306 Compression Locknut	 C0318 Compression Nut	 C0319 Compression Ferrule	 C2402 BT-MJ Straight	 C2403 BT-BT Straight
 C2403-LH BT-BT Straight Large Hex	 C2404 BT-MP Straight	 C2405 BT-FP Straight	 C2406 Tube-BT Straight Reducer	 C2408 Compression Plug	 C2500-FG BT-BT 90° Elbow
 C2501-FG BT-MP 90° Elbow	 C2502-FG BT-FP 90° Elbow	 C2503-FG BT-MP 45° Elbow	 C2504-FG BT-BT 45° Elbow	 C2601-FG BT-BT-MP Branch Tee	 C2602-FG BT-BT-FP Branch Tee
 C2603-FG BT-BT-BT Tee	 C2605-FG BT-MP-BT Run Tee	 C2606-FG BT-FP-BT Run Tee	 C2650-FG BT-BT-BT-BT Cross	 C2700-LN BT-BT Bulkhead Straight	 C2701-LN-FG BT-BT Bulkhead 90° Elbow
 C2702-LN-FG BT-BT Bulkhead 45° Elbow	 C2703-LN-FG BT-BT-BT Bulkhead Branch Tee	 C2704-LN-FG BT-BT-BT Bulkhead Run Tee	 C2705-LN BT-FP Bulkhead Straight	 C2706-LN BT-MP Bulkhead Straight	 C2707-LN BT-MJ Bulkhead Straight
 C6400-O BT-MORB Straight	 C6500-FG BT-BTS 90° Elbow	 C6502-FG BT-BTS 45° Elbow	 C6600-FG BT-BT-BTS Tee	 C6602-FG BT-BTS-BT Tee	 C6801-NWO-FG BT-MAORB 90° Elbow

Compression Fittings (Flareless Bite Type)

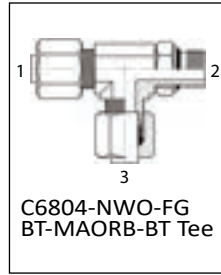
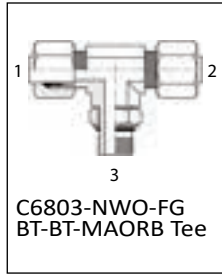

** Please note that our compression fittings are Ermetto style **

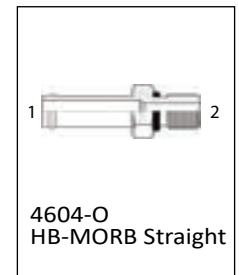
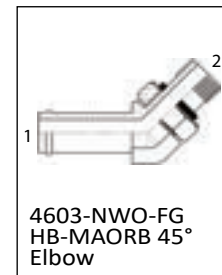
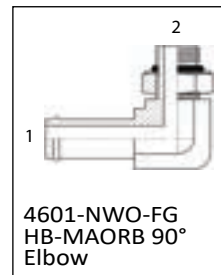
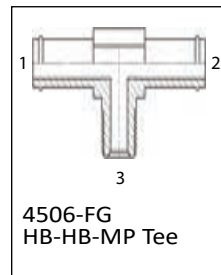
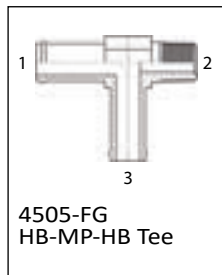
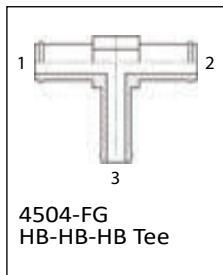
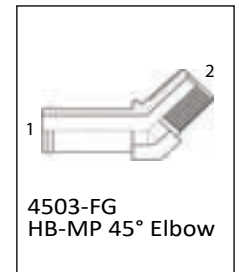
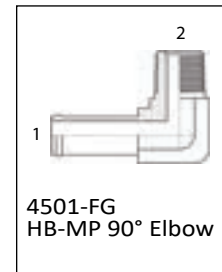
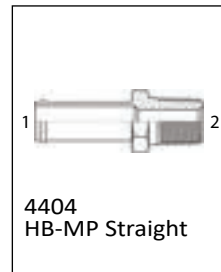
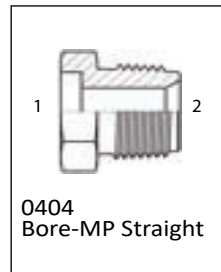
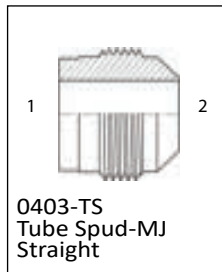
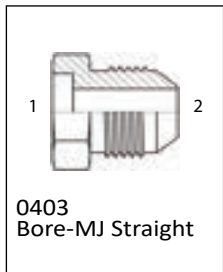

Braze Fittings & Beaded Hose Adapters



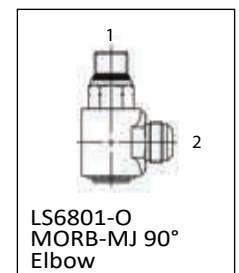
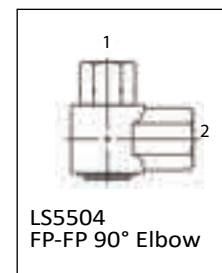
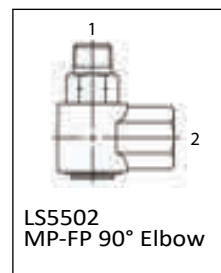
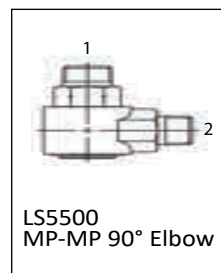
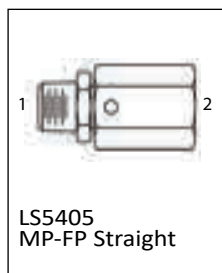
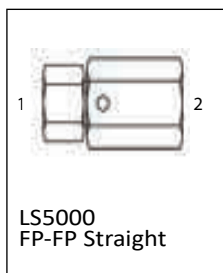
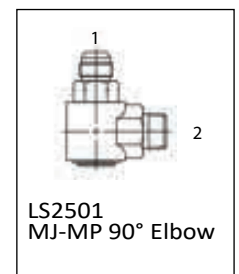
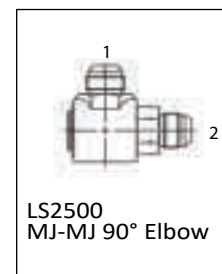
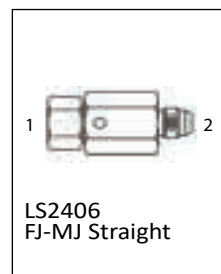
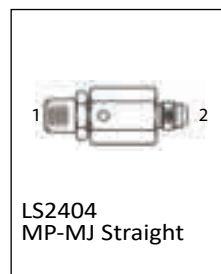
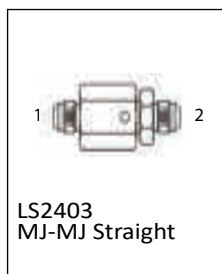
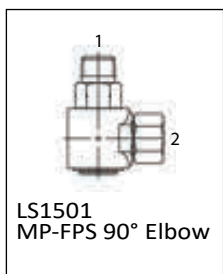

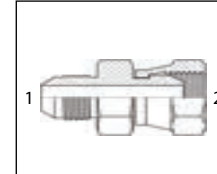
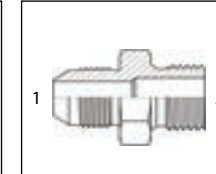

Live Swivels

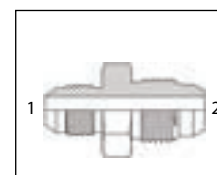
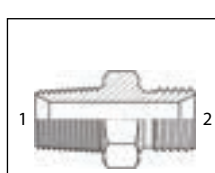
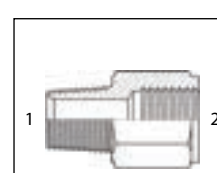
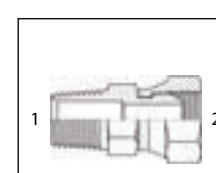
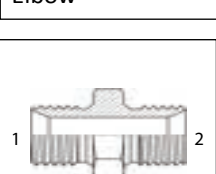

Conversion Adapters (International Threads)



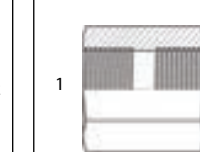
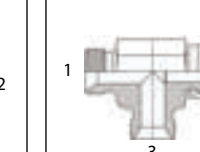
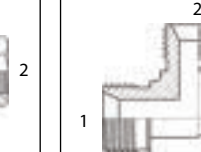
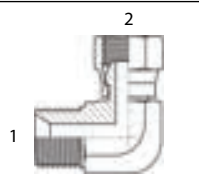
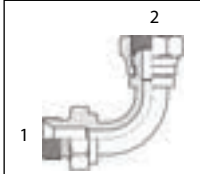
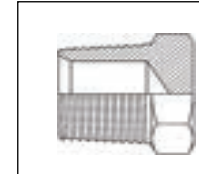
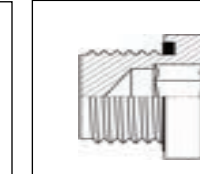
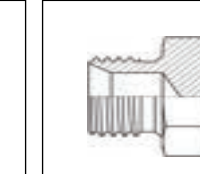
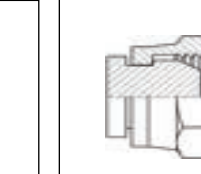





 7000 MJ-MBSPT Straight	 7002 MJ-MBSPP Straight	 7003 MJ-FBSPP Straight	 7004 MJ-FBSPPS Straight	 7005 MJ-MM Port Straight	 7005-L MJ-MM DP Light Straight
 7005-S MJ-MM DP Heavy Straight	 7007-L MJ-FMS Light Straight	 7007-S MJ-FMS Heavy Straight	 7009 MJ-MK Straight	 7022 FJS-MBSPP Straight	 7023 FJS-FBSPPS Straight
 7025 FJS-MM Straight	 7030 MP-MBSPT Straight	 7032 MP-MBSPP Straight	 7033 MP-FBSPP Straight	 7034 MP-FBSPPS Straight	 7040 FP-MBSPT Straight
 7042 FP-MBSPP Straight	 7045 FP-MM Straight	 7062 MORB-MBSPP Straight	 7102-NWO-FG MJ-MBSPPAORB 45° Elbow	 7202-NWO-FG MJ-MBSPPAORB 90° Elbow	 7204-FG MJ-FBSPPS 90° Elbow
 7205-NWO-FG MJ-MMAORB 90° Elbow	 7222-FG FJS-MBSPP 90° Elbow	 7588-P MJIS Plug	 7599-P Komatsu Plug	 7688-C MJIS Cap	 7699-C Komatsu Cap
 8055 MM-MM Straight	 8555-HHP-O MMORB Hollow Hex Plug	 8555-P MM External Hex Plug	 8800 Metric Bonded Seal	 9000 MBSPT-MBSPT Straight	 9022 MBSPP-MBSPP Straight

Conversion Adapters (International Threads)

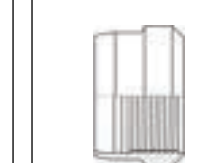
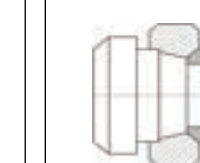

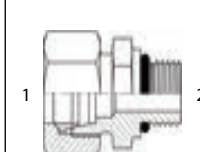

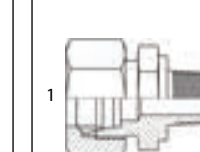

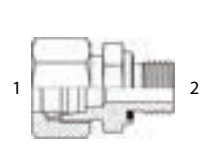
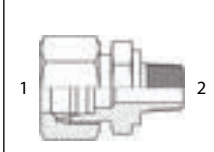

 <p>9023 MBSPP-FBSPP Straight</p>	 <p>9024 MBSPP-FBSPPS Straight</p>	 <p>9025 MBSPP-MM Straight</p>	 <p>9033 FBSPP-FBSPP Straight</p>	 <p>9090-FG MBSPP-FBSPP- MBSPP Run Tee</p>	 <p>9222-FG MBSPP-MBSPP 90° Elbow</p>
 <p>9224-FG MBSPP-FBSPPS 90° Elbow</p>	 <p>9224-L MBSPP-FBSPPS Swept 90° Elbow L</p>	 <p>9500-P MBSPT External Hex Plug</p>	 <p>9522-HHP-O MBSPP Hollow Hex Plug</p>	 <p>9522-P MBSPP Hex Plug</p>	 <p>9644-C FBSPP Cap</p>
 <p>9900 British Bonded Seal</p>					

** Seals sold separately **

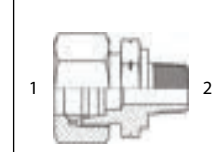
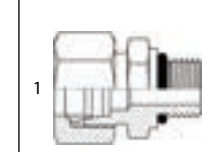
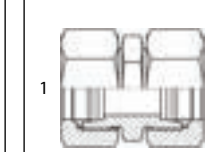
DIN Metric Bite Type Fittings (Available in Light and Heavy)

 <p>DM8002 Bulkhead Locknut</p>	 <p>DM8003 Tube Cap</p>	 <p>DM8004 Tube Plug</p>	 <p>DM8005 Single Bite Flareless Sleeve</p>	 <p>DM8006 Double Bite Flareless Sleeve</p>	 <p>DM8008 Flareless Nut</p>
 <p>DM8030 MBT-MM Straight</p>	 <p>DM8031-PO MBT-MM w/ PO Straight</p>	 <p>DM8032 MBT-MM ISO Straight</p>	 <p>DM8033 MBT-MMT Straight</p>	 <p>DM8034 MBT-FM Straight</p>	 <p>DM8041 MBT-MBSPP Straight</p>

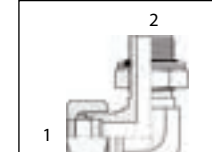
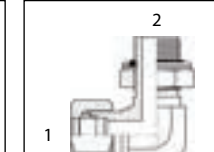
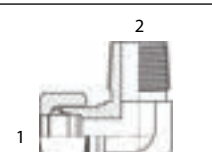
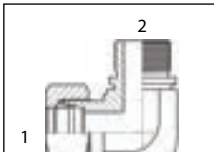
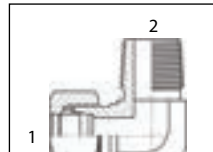
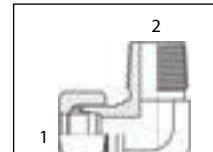
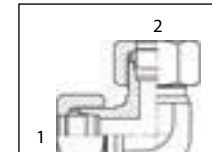
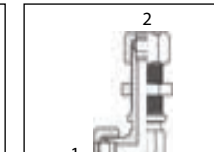
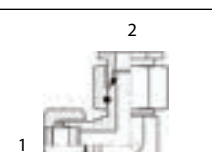
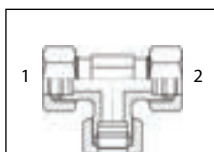
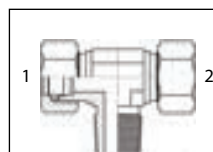

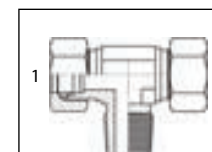
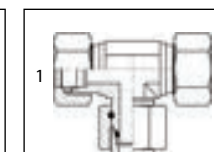
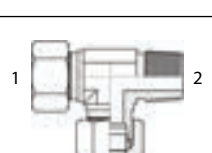
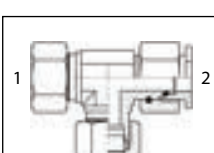
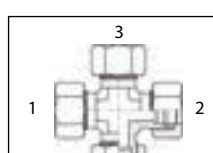







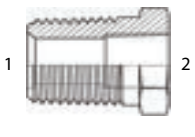

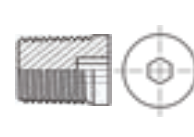

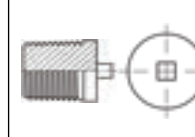
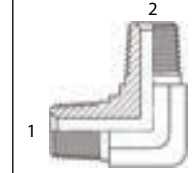
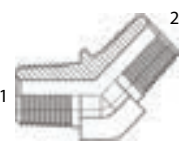
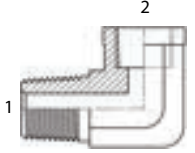

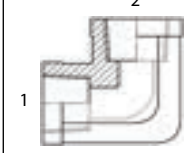
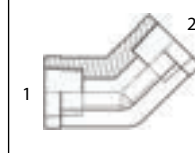
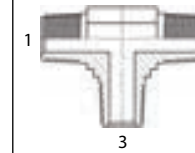
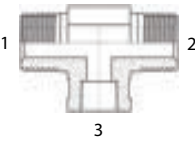
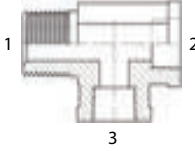
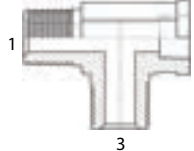
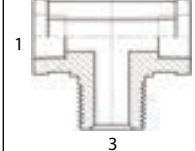
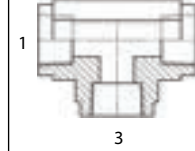
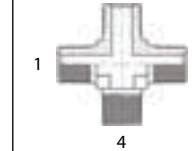
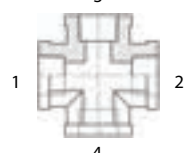
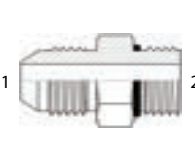

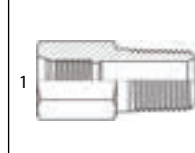
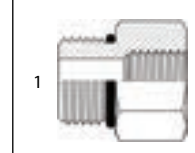
DIN Metric Bite Type Fittings (Available in Light and Heavy)

 <p>DM8041-PO MBT-MBSPP w/ PO Straight</p>	 <p>DM8043 MBT-MBSPT Straight</p>	 <p>DM8044 MBT-FBSPP Straight</p>	 <p>DM8050 MBT-MP Straight</p>	 <p>DM8051-O MBT-MORB Straight</p>	 <p>DM8060 MBT-MBT Straight</p>
 <p>DM8061-LN MBT-MBT Bulkhead</p>	 <p>DM8062 MBT-FMA Straight</p>	 <p>DM8067 FMA-FMA Straight</p>	 <p>DM8098 MBT-MBT Welding Bulkhead</p>	 <p>DM8214-PO-FG MBT-MMA 90° Elbow</p>	 <p>DM8215-PO-FG MBT-MBSPPA 90° Elbow</p>
 <p>DM8233-FG MBT-MMT 90° Elbow</p>	 <p>DM8241-FG MBT-MBSPP 90° Elbow</p>	 <p>DM8243-FG MBT-MBSPT 90° Elbow</p>	 <p>DM8250-FG MBT-MP 90° Elbow</p>	 <p>DM8260-FG MBT-MBT 90° Elbow</p>	 <p>DM8261-LN-FG MBT-MBT Blkhd 90° Elbow</p>
 <p>DM8263-FG MBT-FMA 90° Elbow</p>	 <p>DM8360-FG MBT-MBT-MBT Tee</p>	 <p>DM8361-FG MBT-MBT-MMT Branch Tee</p>	 <p>DM8365-FG MBT-MMT-MBT Run Tee</p>	 <p>DM8443-FG MBT-MBT-MBSPT Branch Tee</p>	 <p>DM8463-FG MBT-MBT-FMA Branch Tee</p>
 <p>DM8543-FG MBT-MBSPT-MBT Run Tee</p>	 <p>DM8563-FG MBT-FMA-MBT Run Tee</p>	 <p>DM8660-FG MBT-MBT-MBT- MBT Cross</p>			

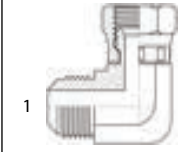
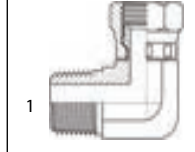
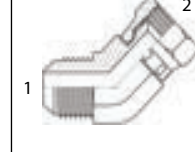
Stainless Steel Tube Fittings & Adapters

 <p>SS-0304-C JIC Cap Nut</p>	 <p>SS-0306 Bulkhead Locknut</p>	 <p>SS-0318 JIC Tube Nut</p>	 <p>SS-0319 JIC Tube Sleeve</p>	 <p>SS-0403 Bore-MJ Straight</p>	 <p>SS-1404 MP-FPS Straight</p>
 <p>SS-1405 FP-FPS Straight</p>	 <p>SS-1501 MP-FPS 90° Elbow</p>	 <p>SS-1502 FP-FPS 90° Elbow</p>	 <p>SS-2403 MJ-MJ Straight</p>	 <p>SS-2404 MJ-MP Straight</p>	 <p>SS-2405 MJ-FP Straight</p>
 <p>SS-2406 FJ-MJ Straight Reducer</p>	 <p>SS-2408 MJ Plug</p>	 <p>SS-2500 MJ-MJ 90° Elbow</p>	 <p>SS-2501 MJ-MP 90° Elbow</p>	 <p>SS-2502 MJ-FP 90° Elbow</p>	 <p>SS-2503 MJ-MP 45° Elbow</p>
 <p>SS-2504 MJ-MJ 45° Elbow</p>	 <p>SS-2601 MJ-MJ-MP Tee</p>	 <p>SS-2602 MJ-MJ-FP Tee</p>	 <p>SS-2603 MJ-MJ-MJ Tee</p>	 <p>SS-2605 MJ-MP-MJ Tee</p>	 <p>SS-2606 MJ-FP-MJ Tee</p>
 <p>SS-2650 MJ-MJ-MJ-MJ Cross</p>	 <p>SS-2700 MJ-MJ Bulkhead Straight</p>	 <p>SS-2701 MJ-MJ Bulkhead 90° Elbow</p>	 <p>SS-2702 MJ-MJ Bulkhead 45° Elbow</p>	 <p>SS-2703 MJ-MJ-MJ Bulkhead Branch Tee</p>	 <p>SS-2704 MJ-MJ-MJ Bulkhead Run Tee</p>
 <p>SS-2705 FP-MJ Bulkhead Straight</p>	 <p>SS-2706 MP-MJ Bulkhead Straight</p>	 <p>SS-5000 FP-FP Straight</p>	 <p>SS-5404 MP-MP Hex Straight</p>	 <p>SS-5404-N MP-MP Long Nipple</p>	 <p>SS-5405 MP-FP Straight Expander</p>

Stainless Steel Tube Fittings & Adapters

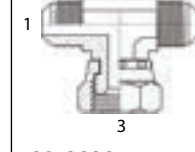
 <p>SS-5406 MP-FP Reducer Bushing</p>	 <p>SS-5406-C Pipe Cap</p>	 <p>SS-5406-HHP Hollow Hex Pipe Plug</p>	 <p>SS-5406-P External Hex Pipe Plug</p>	 <p>SS-5406-SHP Square Head Pipe Plug</p>	 <p>SS-5500 MP-MP 90° Elbow Plug</p>
 <p>SS-5501 MP-MP 45° Elbow</p>	 <p>SS-5502 MP-FP 90° Street Elbow</p>	 <p>SS-5503 MP-FP 45° Elbow</p>	 <p>SS-5504 FP-FP 90° Elbow</p>	 <p>SS-5505 FP-FP 45° Elbow</p>	 <p>SS-5600 MP-MP-MP Tee</p>
 <p>SS-5601 MP-MP-FP Tee</p>	 <p>SS-5602 MP-FP-FP Tee</p>	 <p>SS-5603 MP-FP-MP Tee</p>	 <p>SS-5604 FP-FP-MP Tee</p>	 <p>SS-5605 FP-FP-FP Tee</p>	 <p>SS-5650 MP-MP-MP-MP Cross</p>
 <p>SS-5652 FP-FP-FP-FP Cross</p>	 <p>SS-6400-O MJ-MORB Straight</p>	 <p>SS-6401-O MORB-MP Straight</p>	 <p>SS-6402-O MORB-FJS Straight</p>	 <p>SS-6404 FORB-MP Straight</p>	 <p>SS-6405-O MORB-FP Straight</p>
 <p>SS-6408-O MORB External Hex Plug</p>	 <p>SS-6408-HHP-O MORB Hollow Hex Plug</p>	 <p>SS-6410-O MORB-FORB Straight Reducer</p>	 <p>SS-6500 MJ-FJS 90° Elbow</p>	 <p>SS-6501 MP-FJS 90° Elbow</p>	 <p>SS-6502 MJ-FJS 45° Elbow</p>
 <p>SS-6503 FP-FJS 90° Elbow</p>	 <p>SS-6504 MJ-FJS Straight</p>	 <p>SS-6505 MP-FJS Straight</p>	 <p>SS-6506 FP-FJS Straight</p>	 <p>SS-6565 FJS-FJS Straight</p>	 <p>SS-6600 MJ-MJ-FJS Tee</p>

Stainless Steel Tube Fittings & Adapters

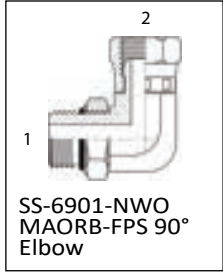
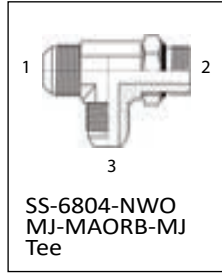
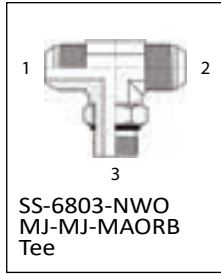
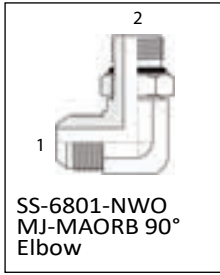
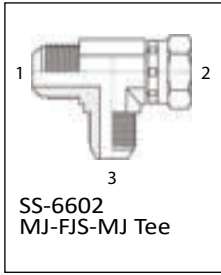

Stainless Steel Conversion Adapters (International Threads)

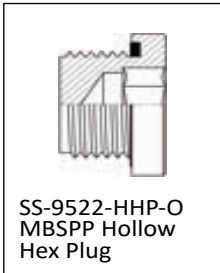
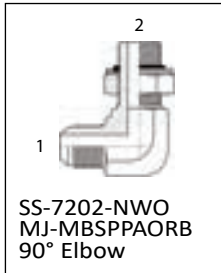
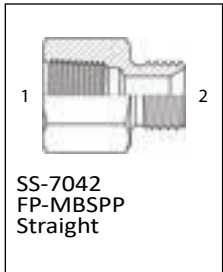
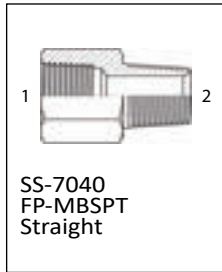
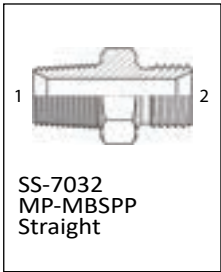
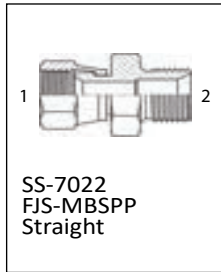
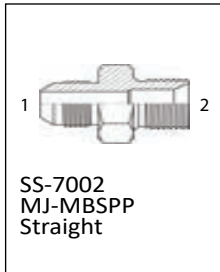
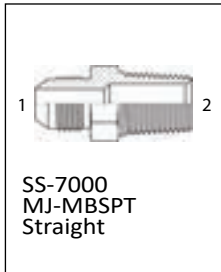

** Seals sold separately **











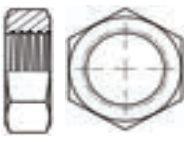
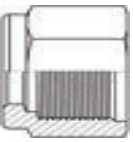
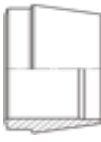
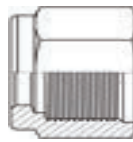











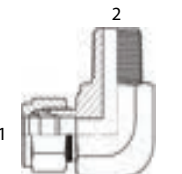
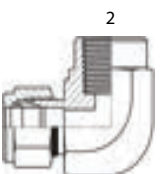

Stainless Steel Tubing

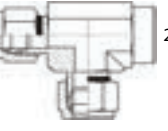
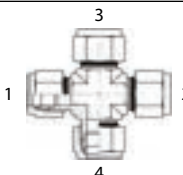

OMi offers stainless steel seamless tubing in both 304/304L and 316/316L grades. Meets ASTM A269, and MTRs available upon request.

Part Number: SS304-TP, SS316-TP
 Length: 10 ft, 20 ft
 Tube OD size: 1/4", 3/8", 1/2", 5/8", 3/4", 1"
 Wall thickness: .035, .049, .065

Stainless Steel Compression & Instrumentation Fittings

 SS-IN0304-C IN Cap	 SS-C0306 Compression Bulkhead Locknut	 SS-C0318 Compression Nut	 SS-C0319 Compression Sleeve	 SS-IN0318 IN Nut	 SS-IN0319-B IN Back Ferrule
 SS-IN0319-F IN Front Ferrule	 SS-IN2402 IN-MJ Straight	 SS-IN2403 IN-IN Straight Union	 SS-IN2404 IN-MP Straight Connector	 SS-IN2405 IN-FP Straight Connector	 SS-IN2406 Tube-IN Reducer
 SS-IN2408 IN Plug	 SS-IN2425 IN-BW Male Connector	 SS-IN2426 IN-SW Male Connector	 SS-IN2500 IN-IN Union 90° Elbow	 SS-IN2501 IN-MP 90° Elbow	 SS-IN2502 IN-FP 90° Elbow
 SS-IN2503 IN-MP 45° Elbow	 SS-IN2601 IN-IN-MP Branch Tee	 SS-IN2602 IN-IN-FP Branch Tee	 SS-IN2603 IN-IN-IN Union Tee	 SS-IN2605 IN-MP-IN Run Tee	 SS-IN2606 IN-FP-IN Run Tee
 SS-IN2650 IN-IN-IN-IN Cross	 SS-IN2700-LN IN Bulkhead-IN Straight	 SS-IN2705-LN IN Bulkhead-FP Straight	 SS-IN2706-LN IN Bulkhead-MP Straight	 SS-IN2707-LN IN Bulkhead-MJ Straight	 SS-IN6400-O IN-MORB Straight

** Fittings are available in single ferrule and double ferrule designs. Parts above represent double ferrule design. For single ferrule substitute "C" for "IN". **

Kits

Cap & Plug Kits

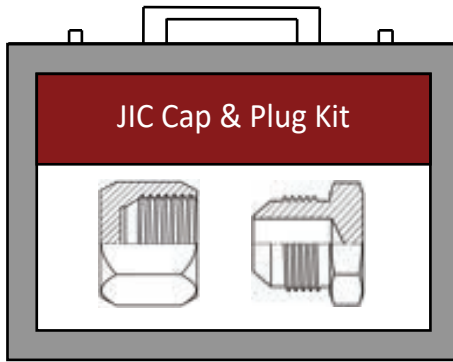

KIT-JIC
JIC Cap and Plug Kit
0304-C, 2408

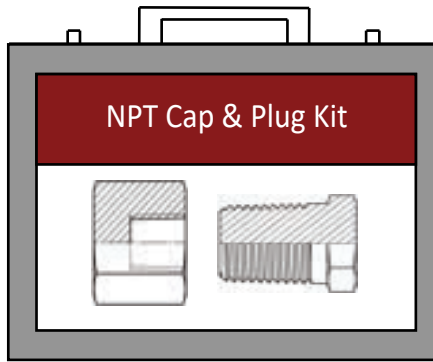

KIT-NPT
NPT Cap and Plug Kit
5406-C, 5406-P

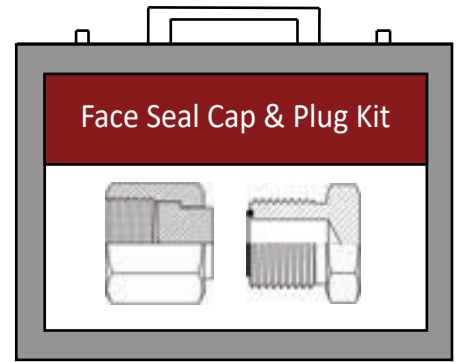

KIT-FS
FS Cap and Plug Kit
FS0304-C, FS2408

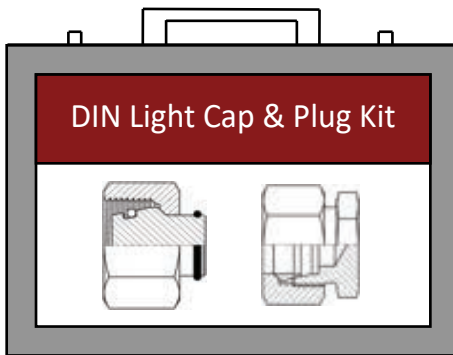

KIT-DIN-L
DIN Metric Cap and Plug Kit -
Light Series
DM8003-L, DM8004-L

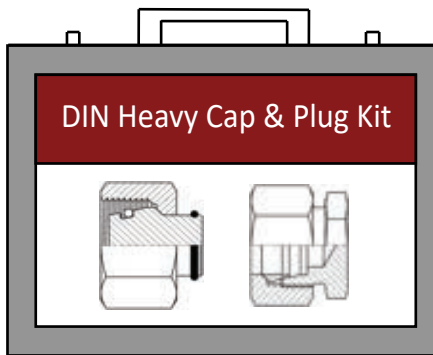

KIT-DIN-S
DIN Metric Cap and Plug Kit -
Heavy Series
DM8003-S, DM8004-S

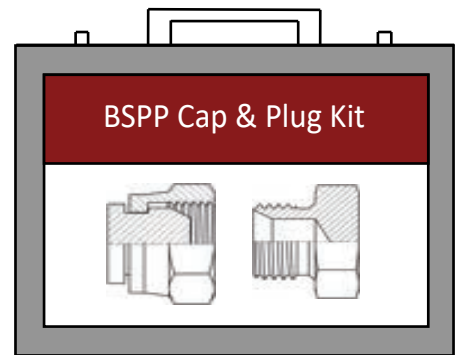

KIT-BSPP
BSPP Cap and Plug Kit
9644-C, 9522-P

O-Ring Kits



KIT-ORING-BOSS
4000 Series O-Ring Kit

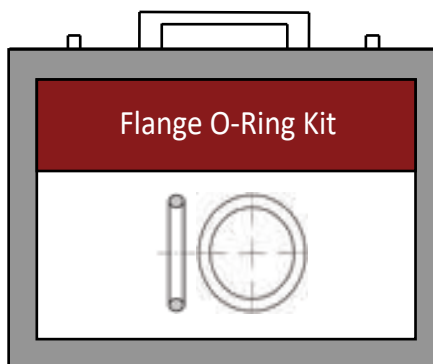

KIT-ORING-FLANGE
4005 Series O-Ring Kit



KIT-ORING-FS
FS4000 Series O-Ring Kit

Hydraulic Hoses

SAE 100R1AT DIN EN853 1SN

OM1SN

OMi-HOSE

HI-PERFORMANCE BRAIDED SERIES-TYPE-EN 853 1SN
MEETS AND EXCEEDS SAE 100R1AT FLAME RETARDANT COVER
MSHA IC - 316/1

DIN EN 853 1SN/SAE 100 R1 AT

DASH SIZE	4	5	6	8	10	12	16	20	24	32
ID Inch	1/4	5/16	3/8	1/2	5/8	3/4	1	1 1/4	1 1/2	2
MAX WP psi	3260	3110	2610	2320	1880	1520	1270	910	720	580

REINFORCEMENT: One braid of high-tensile steel wire

COVER: Environment resistant synthetic rubber (Wrap or Smooth Cover)

SAE 100R2AT DIN EN853 2SN

OM2SN

OMi-HOSE

HI-PERFORMANCE BRAIDED SERIES-TYPE-EN 853 2SN
MEETS AND EXCEEDS SAE 100R2AT FLAME RETARDANT COVER
MSHA IC - 316/1

DIN EN 853 2SN/SAE 100 R2 AT

DASH SIZE	4	5	6	8	10	12	16	20	24	32
ID Inch	1/4	5/16	3/8	1/2	5/8	3/4	1	1 1/4	1 1/2	2
MAX WP psi	5800	5080	5000	5000	3625	3120	2395	1815	1305	1160

REINFORCEMENT: Two braids of high-tensile steel wire

COVER: Environment resistant synthetic rubber (Wrap or Smooth Cover)

DIN EN856 4SH

OM4SH

OMi-HOSE

PULSE-MASTER SERIES 4SH EN 856 MSHA IC - 316/1

DIN EN 856 4SH

DASH SIZE	12	16	20	24	32
ID Inch	3/4	1	1 1/4	1 1/2	2
MAX WP psi	6090	5510	4714	4205	3650

REINFORCEMENT: Four high-tensile steel spirals

COVER: Ozone resistant synthetic rubber, MSHA approved (flame resistant)

SAE 100R13 DIN EN856 R13

OMR13

OMi-HOSE

PULSE-MASTER SERIES 13 SAE100R13 MSHA IC316/1

SAE 100R13

DASH SIZE	12	16	20	24	32
ID Inch	3/4	1	1 1/4	1 1/2	2
MAX WP psi	5075	5075	5075	5075	5075

REINFORCEMENT: Four or Six high-tensile steel spirals
(up to 16 dash size is four wires)

COVER: Environment resistant synthetic rubber (flame resistant)

SAE 100 R15

OMR15

OMi-HOSE

PULSE-MASTER SERIES 15 SAE100R15 MSHA IC-316/1

SAE 100 R15

DASH SIZE	6	8	10	12	16	20	24
ID Inch	3/8	1/2	5/8	3/4	1	1 1/4	1 1/2
MAX WP psi	6090	6090	6090	6090	6090	6090	6090

REINFORCEMENT: Four or Six high-tensile steel spirals
(up to 16 dash size is four wires)

COVER: Environment resistant synthetic rubber, MSHA approved
(flame resistant)

SAE 100 R16

OMR16

OMi-HOSE

HI-PERFORMANCE BRAIDED COMPACT
SERIES-TYPE SAE100R16-DIN EN857 2SC
FLAME RETARDANT COVER MSHA IC - 316/1

SAE 100 R16

DASH SIZE	4	5	6	8	10	12	16	20
ID Inch	1/4	5/16	3/8	1/2	5/8	3/4	1	1 1/4
MAX WP psi	5800	5075	4785	4000	3625	3120	2395	1815

REINFORCEMENT: Two braids of high-tensile steel wire

COVER: Environment resistant synthetic rubber, MSHA approved
(flame resistant)

Hydraulic Hoses

SAE 100 R17

OMR17

OMi-HOSE

HI-PERFORMANCE BRAIDED COMPACT SERIES -TYPE
SAE100R17 FLAME RETARDANT COVER MSHA IC-316/1

SAE 100 R17

DASH SIZE	4	5	6	8	10	12	16
ID Inch	1/4	5/16	3/8	1/2	5/8	3/4	1
MAX WP psi	3045	3045	3045	3045	3045	3045	3045

REINFORCEMENT: One or Two braids of high-tensile steel wire
(up to 8 dash size is one wire)

COVER: Environment resistant synthetic rubber (Wrap or Smooth Cover),
MSHA approval (flame resistant)

Industrial Hoses

Tank Truck Petroleum Suction &
Discharge Hose 150 PSI

OMPSD150

OMi-HOSE

TANK TRUCK OIL SUCTION AND DISCHARGE
RUBBER HOSE - WP 150 PSI

TANK TRUCK

SIZE Inch	2	2.5	3	3.5	4	5	6	8
MAX WP psi	150	150	150	150	150	150	150	150

REINFORCEMENT: Multiple textile cords and helix wire

COVER: NBR/NITRILE

Tank Truck Petroleum Suction &
Discharge Hose 300 PSI

OMPSD300

OMi-HOSE

TANK TRUCK OIL SUCTION AND DISCHARGE
RUBBER HOSE - WP 300 PSI

TANK TRUCK

SIZE Inch	2	2.5	3	3.5	4	5	6	8
MAX WP psi	300	300	300	300	300	300	300	300

REINFORCEMENT: Multiple textile cords and helix wire

COVER: NBR/NITRILE

UHMW PE Chemical Hose

OMMW150

OMi-HOSE

UHMW CHEMICAL SUCTION AND DISCHARGE
HOSE - WP 150 PSI

UHMW PE GREEN CHEMICAL SMOOTH

SIZE Inch	1	1 1/2	2	2 1/2	3
MAX WP psi	150	150	150	150	150

REINFORCEMENT: High-tensile textile with helix steel wire

COVER: EPDM synthetic rubber

Pressure Washer Hose - 1W

OMPW-4K

OMi-HOSE

PRESSURE WASHER HOSE - WP 4,000PSI

DASH SIZE	6	8
ID Inch	3/8	1/2
MAX WP psi	4000	4000

REINFORCEMENT: One high-tensile steel braid

COVER: Ozone resistant synthetic rubber, MSHA approved
(flame resistant)

Pressure Washer Hose - 2W

OMPW-6K

OMi-HOSE

PRESSURE WASHER HOSE - WP 6,000PSI

DASH SIZE	6	8
ID Inch	3/8	1/2
MAX WP psi	6000	6000

REINFORCEMENT: Two high-tensile steel braids



COVER: Ozone resistant synthetic rubber, MSHA approved
(flame resistant)

Hose Crimp Fittings

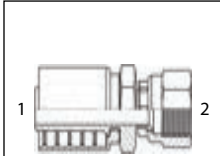
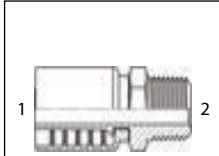
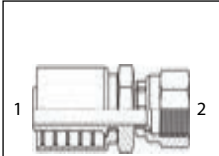
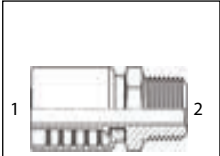
HY-Series: Fittings are similar to Weatherhead U-series. They can be used with SAE 100R1, 100R2, R16 and R17.

Carbon Steel			Stainless Steel		
	OMHY-FJS Hose-FJS Straight	OMHY-MP Hose-MP Straight		SS-OMHY-FJS Hose-FJS Straight	SS-OMHY-MP Hose-MP Straight

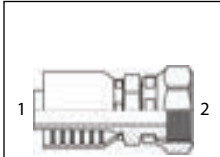
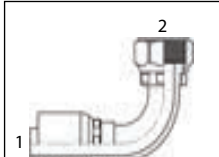
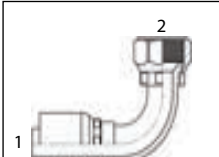
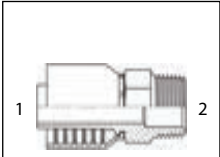
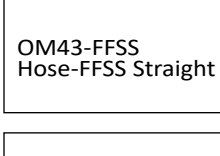
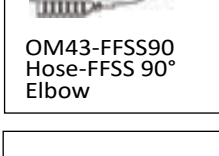
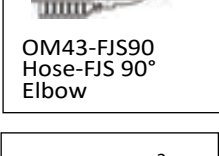
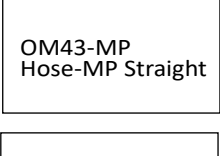
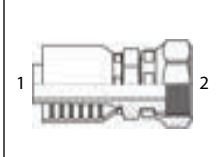
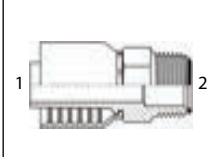
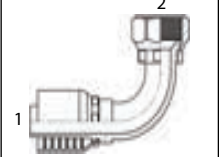

43-Series: Fittings are bite to wire. They can be used with SAE 100R1, 100R2, R16, R17 and 2SC.

Carbon Steel			Stainless Steel		
	OM43-FFSS Hose-FFSS Straight	OM43-FFSS90 Hose-FFSS 90° Elbow		SS-OM43-FFSS Hose-FFSS Straight	SS-OM43-FFSS90 Hose-FFSS 90° Elbow
Carbon Steel			Stainless Steel		
	OM43-FJS Hose-FJS Straight	OM43-FJS90 Hose-FJS 90° Elbow		SS-OM43-FJS Hose-FJS Straight	SS-OM43-FJS90 Hose-FJS 90° Elbow
Carbon Steel			Stainless Steel		
	OM43-MP Hose-MP Straight	OM43-MP Hose-MP Straight		SS-OM43-MP Hose-MP Straight	SS-OM43-MP Hose-MP Straight

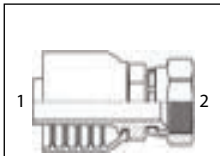
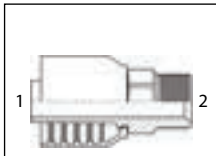
BW-Series: Fittings are bite to wire. They can be used with SAE 100R1, 100R2, R12, R16, R17 and 4SH.

Stainless Steel		
	SS-OMBW-FJS Hose-FJS Straight	SS-OMBW-MP Hose-MP Straight

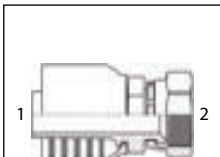
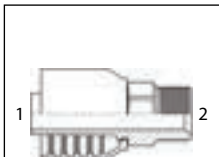
73-Series: Fittings are bite to wire. They can be used with 4 or 6 wire spiral hose.

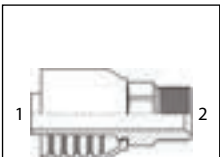
Carbon Steel			Stainless Steel		
	OM73-FJS Hose-FJS Straight	OM73-MP Hose-MP Straight		SS-OM73-FJS Hose-FJS Straight	SS-OM73-MP Hose-MP Straight



Quality

Factories ISO 9001:2015 certified
Material Test Reports & Certificate of Conformance available on domestic & import fittings
Meet or exceed applicable SAE & ASTM requirements

Price

Competitive prices on import and domestic items
Confident that we will lower your costs

Reliability

Stock in Houston: over 4,000 SKUs in Houston Warehouse
Just in time deliveries/blanket orders

Service

Technical expertise is one phone call away
Same-Day shipping on orders received by 4:00 p.m. CST

Manufacturing Capabilities

We offer stamping/forming, casting (die casting, vacuum casting, investment casting), injection molding & machining, both domestic and import. Custom fittings and kit assemblies also available.
Private labeling and special container pricing also offered.

OM INDUSTRIAL PRODUCTS CORP. CORPORATE OFFICE

3334 Creekmont Drive, Houston, TX 77091

P: (713) 462-7900 • F: (713) 462-7957

Toll Free: 1-888-OM-FITTINGS (1-888-663-4884) • Toll Free Fax: 1-888-697-6951

www.omindustrial.com • sales@omindustrial.com

MIDWEST OFFICE

623 S. 1st Street, Clinton, Iowa 52732

P: (563) 278-5640 • clinton@omindustrial.com