

# N2LOK

Hardware Trading Pty Ltd

**INOXUS**  
SERIES

LIMITED WARRANTY  
**7**  
YEAR  
MECHANICAL

LIMITED WARRANTY  
**5**  
YEAR  
FINISH

Thank you for choosing the Inoxus Series mortise Roller Bolt Kit which will give many years of reliable service.

## Installation Instructions for Mortise Roller Bolt Kit

### Door Preparation

**1** Select the preferred position on your door where you want the Mortise Roller Bolt to be placed. Note this will depend on the style of the door and existing preparations or pre-installed door furniture.

**2** Place template on the centre line of the door edge then mark off the centres for the 14.3mm (9/16") diameter holes.

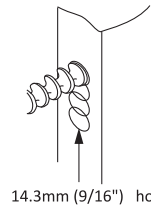
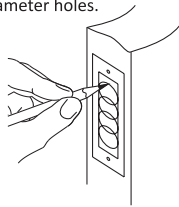

**3** Drill pilot holes at the 4 centre points using a 2.5mm (3/32") drill bits.

**4** Using a 14.3mm (9/16") drill and the pilot holes as a guide drill 4 holes to a depth of 57mm (2-1/4") deep.

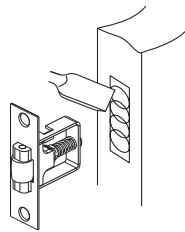

**5** Use a Chisel to clean out the cavity so the Main Assembly can fit this cavity with ease.

**6** With the Main Assembly centrally in the cavity use a sharp pencil to show the outline of the Face Plate then remove.

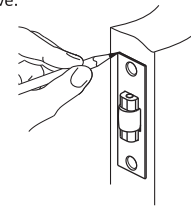

**7** Carefully Chisel within the Face Plate outline to an even depth of 2.5mm (3/32").

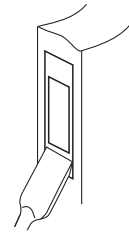

**8** Slide Mortise Roller Bolt Main Assembly back into the cavity then install SSS Face Plate onto the Main Assembly then drill 2 holes with a 2.5mm (3/32") drill bit centrally through the 2 holes in the SSS Face Plate then install 2 CSK fixing screws until firm & face plate is flush to door edge.

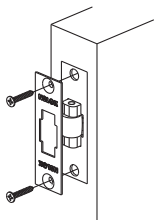

Optional Strike Plates



**9** Shut against door jamb then mark the centre for the strike plate on the jamb then open door.

**10** Place the desired strike in the correct & centred position and mark the outline with a sharp pencil, now chisel with the outline to an even depth of 1mm (3/64").

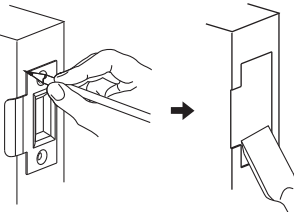

**11** Using the template again to mark with a sharp pencil the roller cut out under the striker, which is 19mm wide and 36mm high as shown on the template then chisel to an even depth of 5mm (3/16") with in this outline.

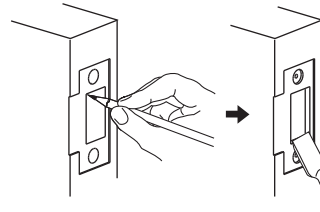

**12** Place the Strike Plate in position then drill 2 fixing holes with a 2.5mm(3/32") drill bit centrally through the 2 holes in the SSS Strike Plate, then install the 2 csk fixing screws until firm & the Strike Plate is flush with the door jamb surface.

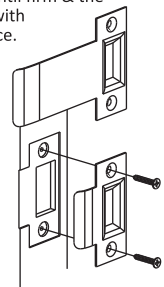

### Adjusting the Roller Bolt

1. The Roller Bolt can be adjusted to suit the gap between the door and the jamb, establish the require amount of projection of the Roller Bolt is needed for smooth and firm self latching.
2. With Main Assembly removed from the door , loosen the Locking Nut then turn the Adjusting Screw to the desired projection.
3. To Retract the Roller Bolt turn the Adjusting Screw in a Clockwise direction then tighten the Locking Nut.
4. To Extend the Roller Bolt turn the Adjusting Screw in a Counter Clockwise direction then tighten the Locking Nut.
5. Reinstall the Main Assembly the SSS Face Plate with the 2 CSK fixing screws to complete the installation

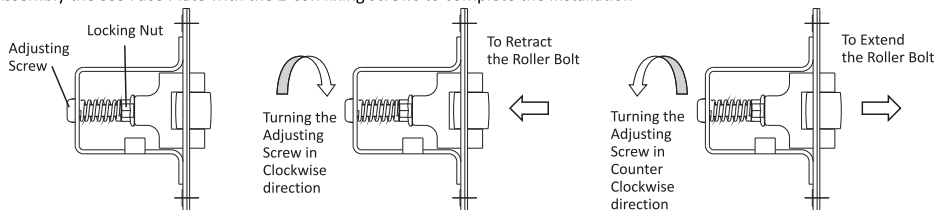

# Mortise Roller Bolt Template

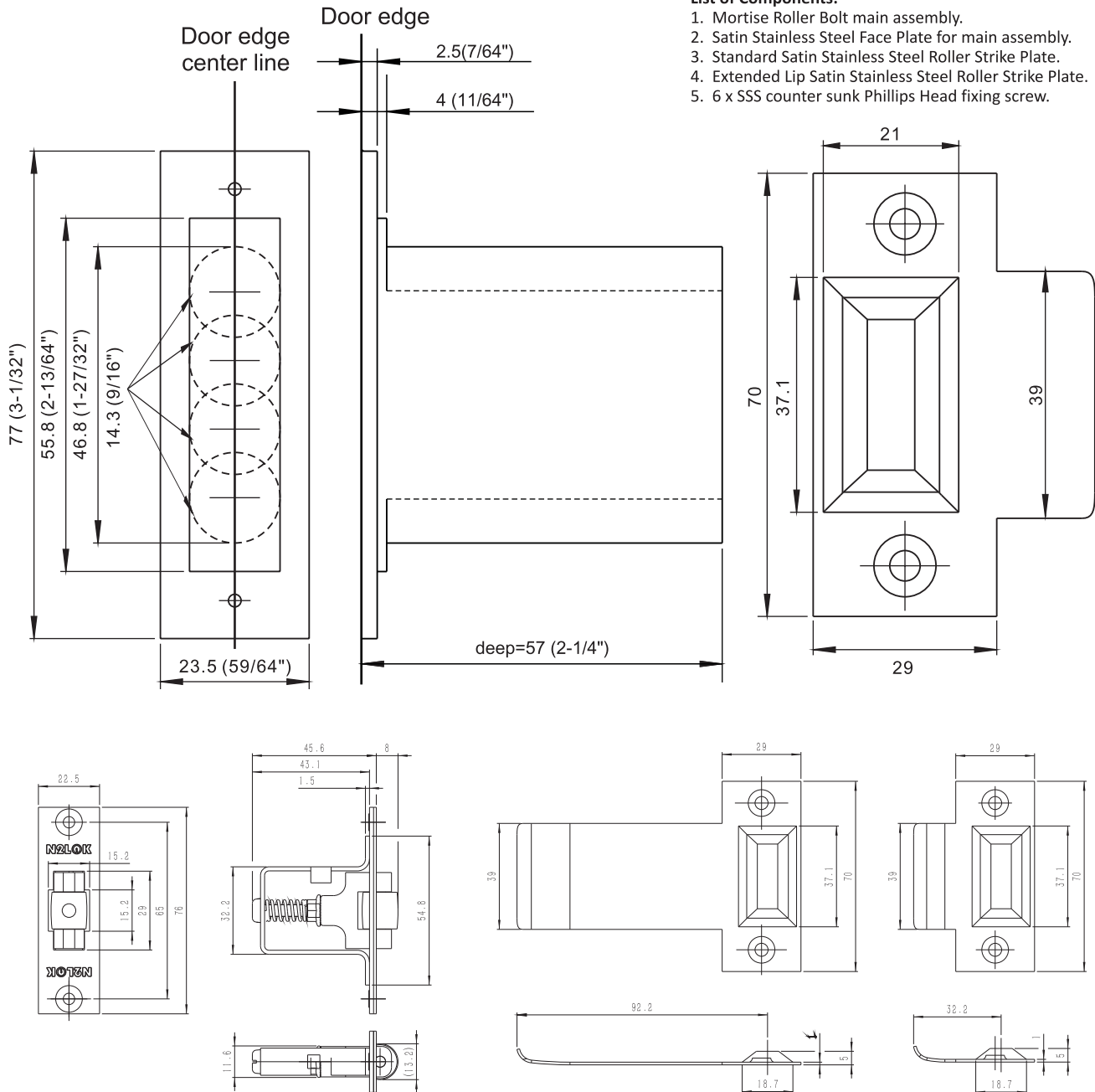

## List of Components:

1. Mortise Roller Bolt main assembly.
2. Satin Stainless Steel Face Plate for main assembly.
3. Standard Satin Stainless Steel Roller Strike Plate.
4. Extended Lip Satin Stainless Steel Roller Strike Plate.
5. 6 x SSS counter sunk Phillips Head fixing screw.



This product is warranted to be free from mechanical & workmanship defects for 7 years and free from finish & surface defects for 5 years from the original date of purchase. Should a mechanical or finish defect occur within this warranty period just return the product along with proof of purchase to point of purchase for replacement. Premature finish deterioration due to the use of solvents, acid cleaners, paints, climatic conditions i.e. salt air or surface abrasion by keys or jewellery is not considered a defect & thus not covered by this warranty. The same applies for mechanical failure due to the incorrect installation, misuse or abuse will not be covered by this warranty. The removal & refitting of the product & any associated handling & transportation costs is not covered by this warranty. N2LOK reserves the right to modify product styles & finishes without notification. If the same product model is no longer available a similar product model will be supplied. Any accessories, spare parts & trim purchased separately to complete & compliment the lockset or hardware are not covered by this warranty.

