

M-STATION ACADEMY

# **ASSEMBLY MANUAL**



# ASSEMBLY CHAPTERS

---

<b>1. Parts &amp; Tools</b>	Page	3
<b>2. Front Frame</b> (step 1-9)	Page	4
<b>3. Back Frame</b> (step 10-11)	Page	10
<b>4. Front- &amp; Back Frame</b> (step 12-14)	Page	11
<b>5. Net</b> (step 15-21)	Page	13
<b>6. Safety strap &amp; Wheels</b> (step 22-23)	Page	20
<b>7. Smartphone Holder &amp; MuninPlay</b> (step 24-27)	Page	22

## Get involved

Upload your #mstation videos and images   

# PARTS & TOOLS



- 1) Make sure that all of the parts are included in the package before you start assembling the m-station. Please, be aware that the color of the parts may differ from the color of the depicted parts in the manual.
- 2) If any of the parts are missing or damaged please contact us at [service@muninsports.com](mailto:service@muninsports.com). If any of the parts are damaged please attach a photo in the e-mail.
- 3) You need a rubber mallet/hammer (not included). Do not use a regular hammer or pliers.

# FRONT FRAME

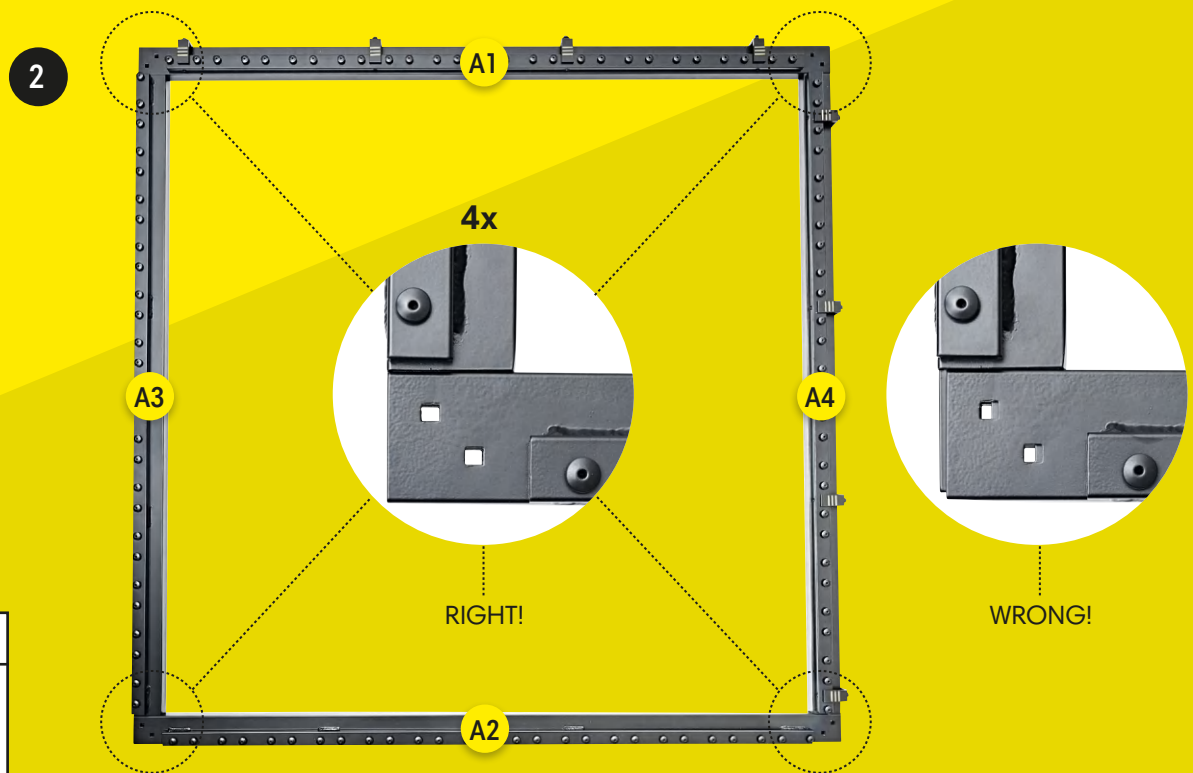
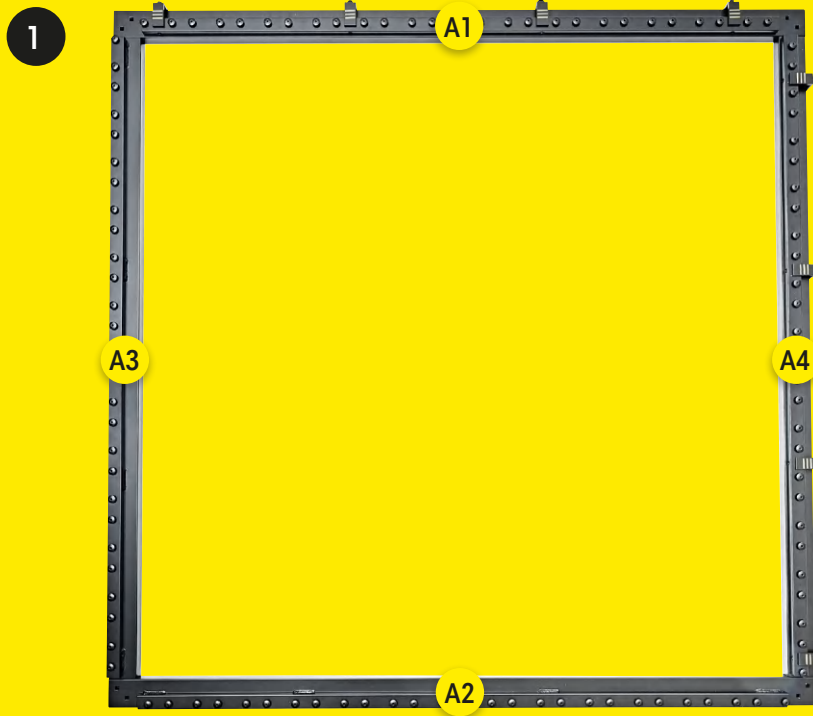

# FRONT FRAME

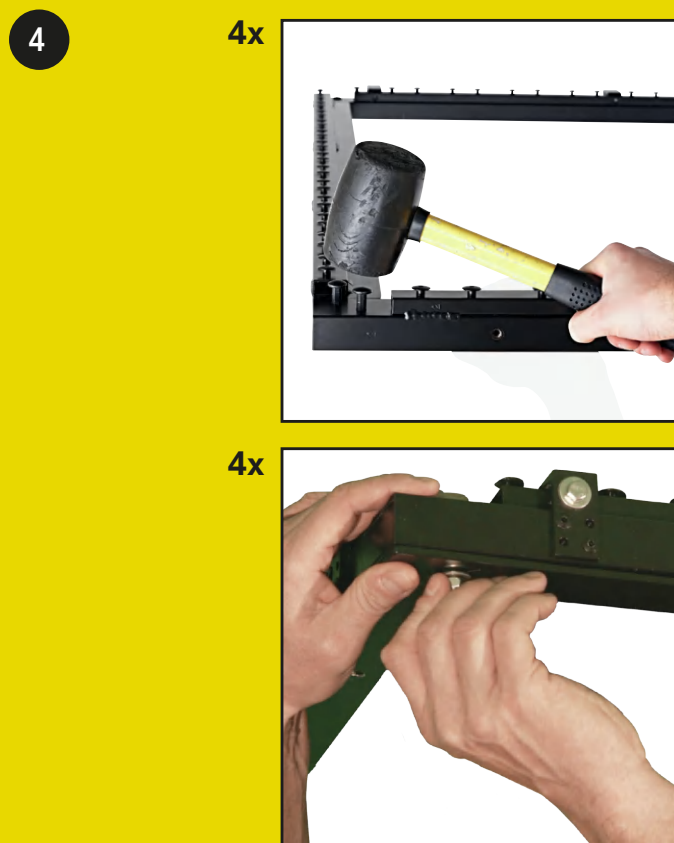
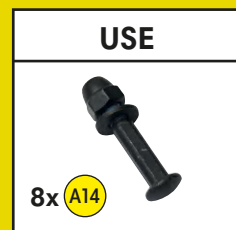
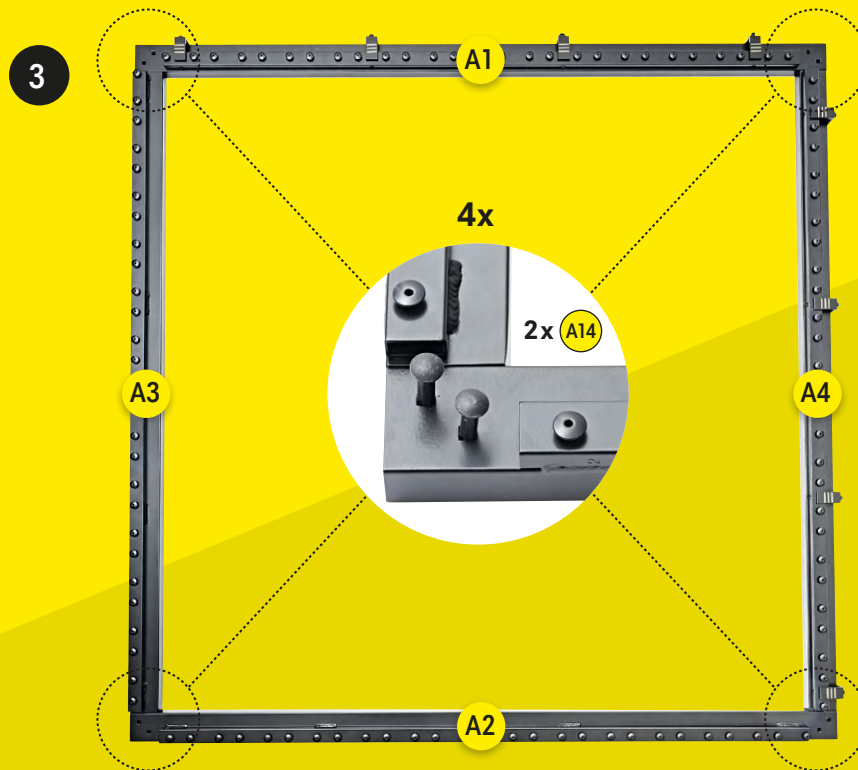

# FRONT FRAME

---

5

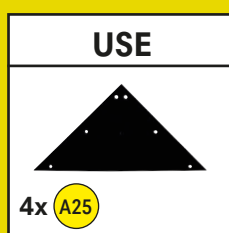
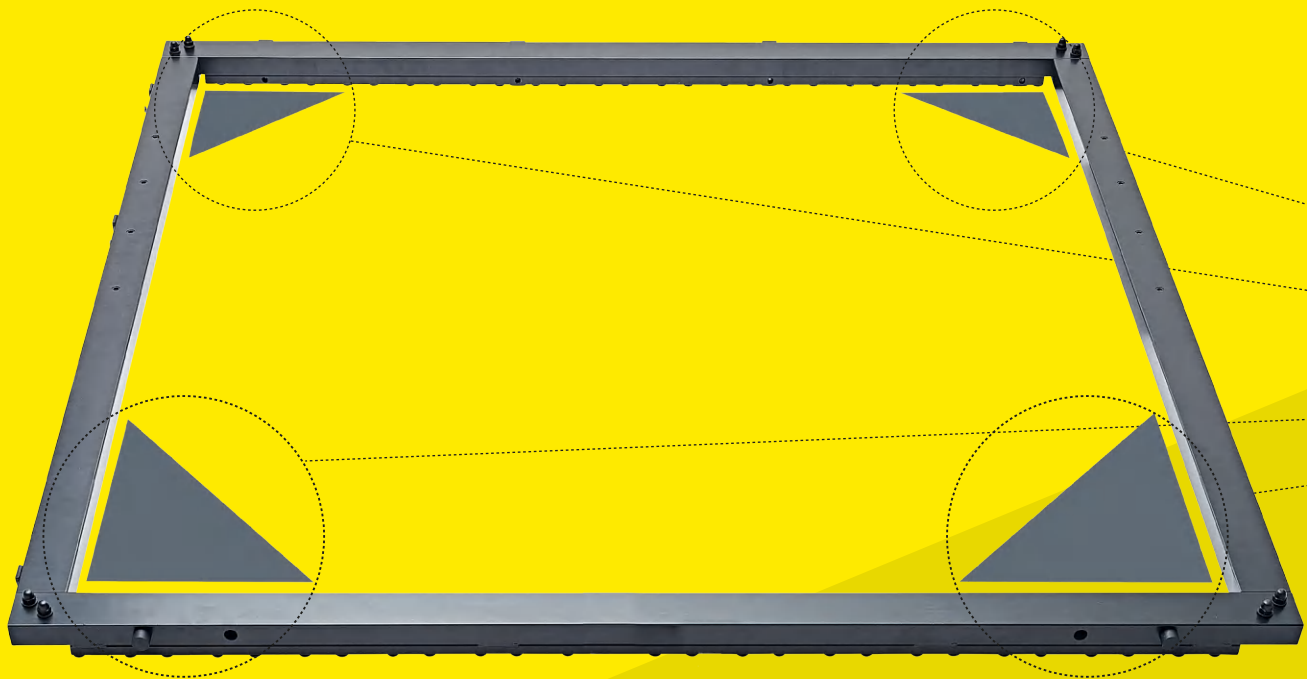

# FRONT FRAME

6

4x

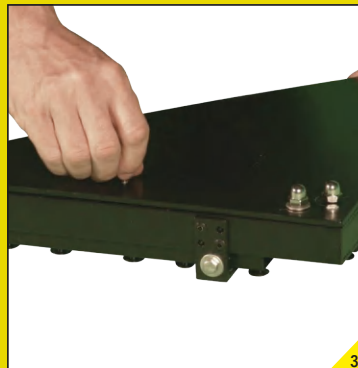

FIRST:  
TIGHTEN WITH TOOL P

SEKOND:  
TIGHTEN WITH TOOL Q

USE



16x A16

# FRONT FRAME

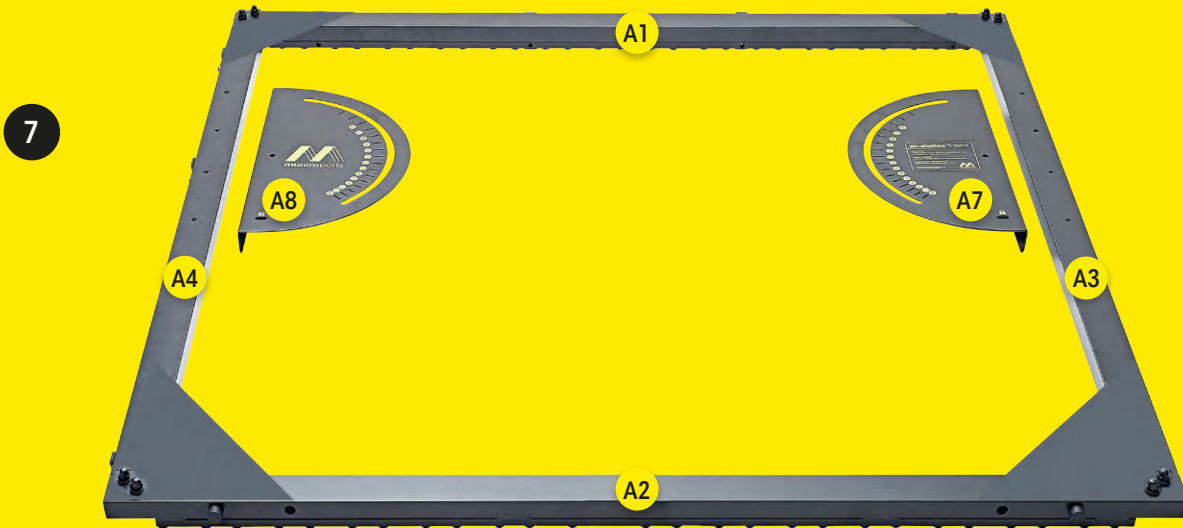



# FRONT FRAME

9

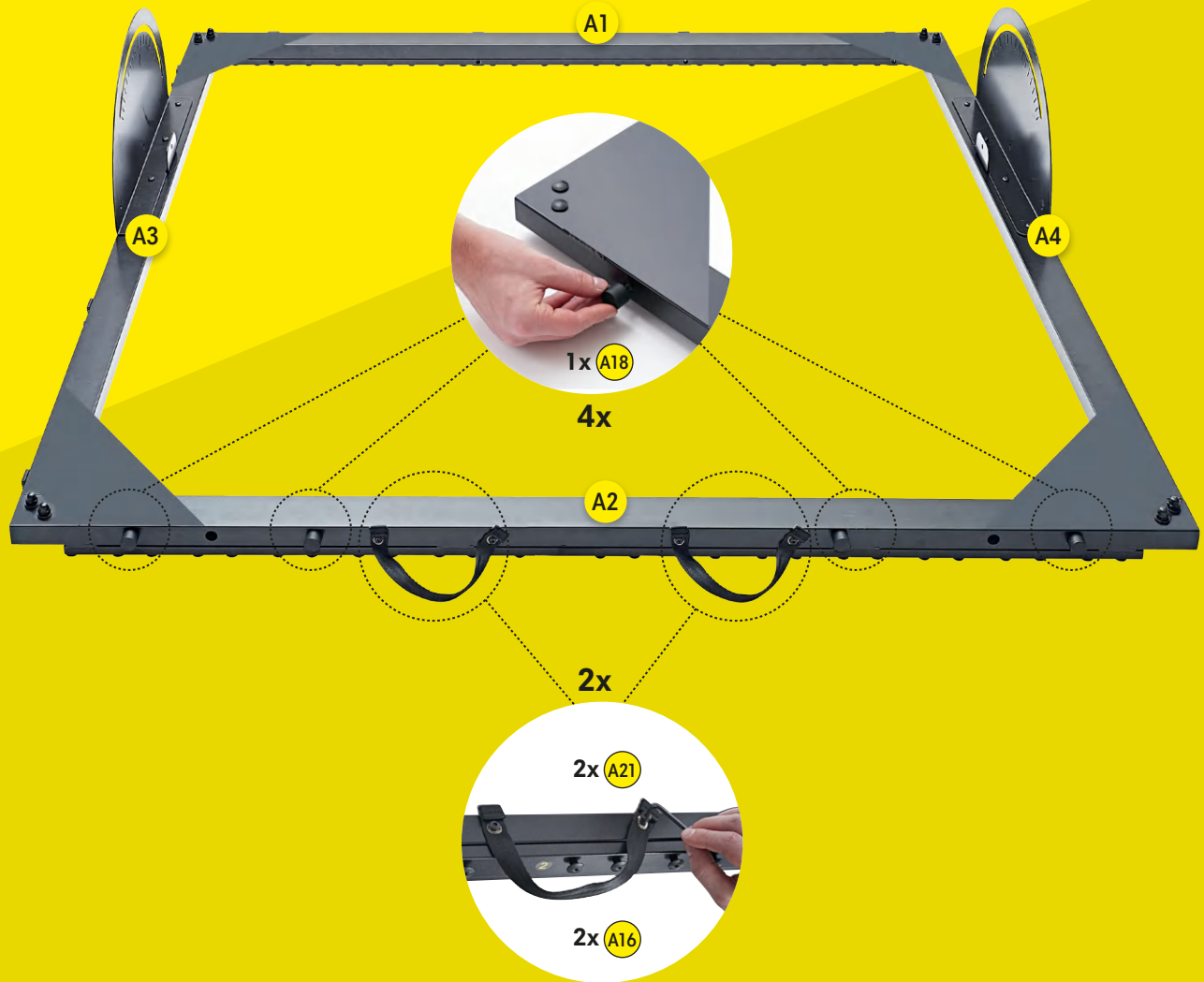

USE	USE	USE
 2x (A21)	 4x (A16)	 4x (A18)

# BACK FRAME

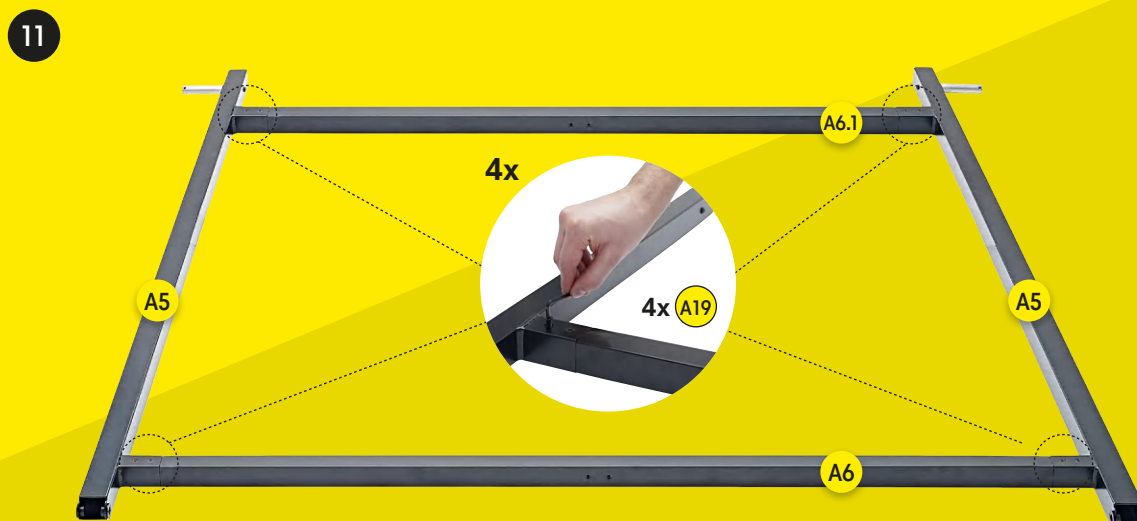
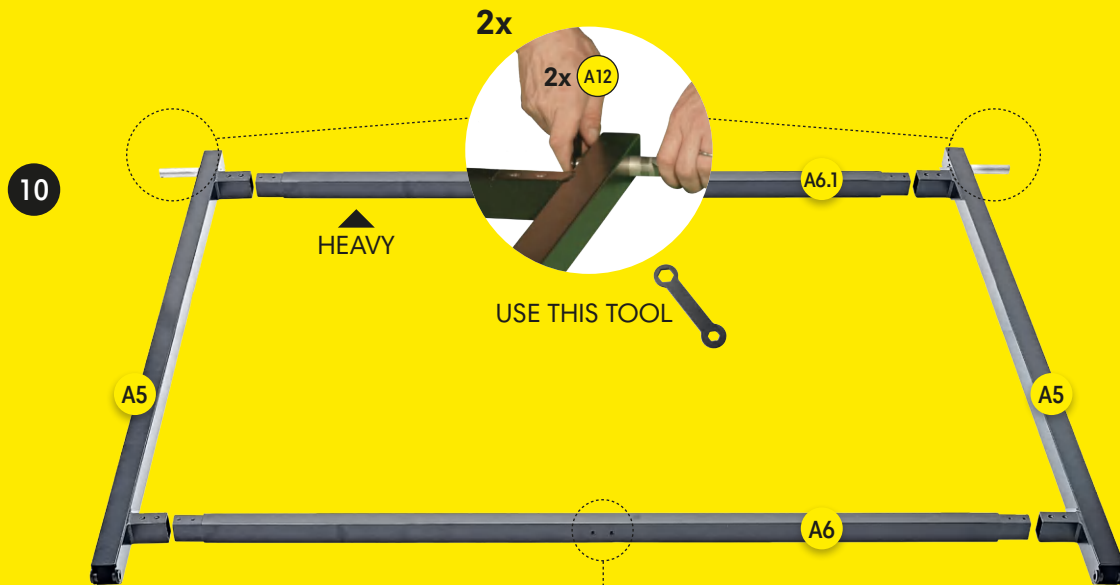

# FRONT- & BACK FRAME

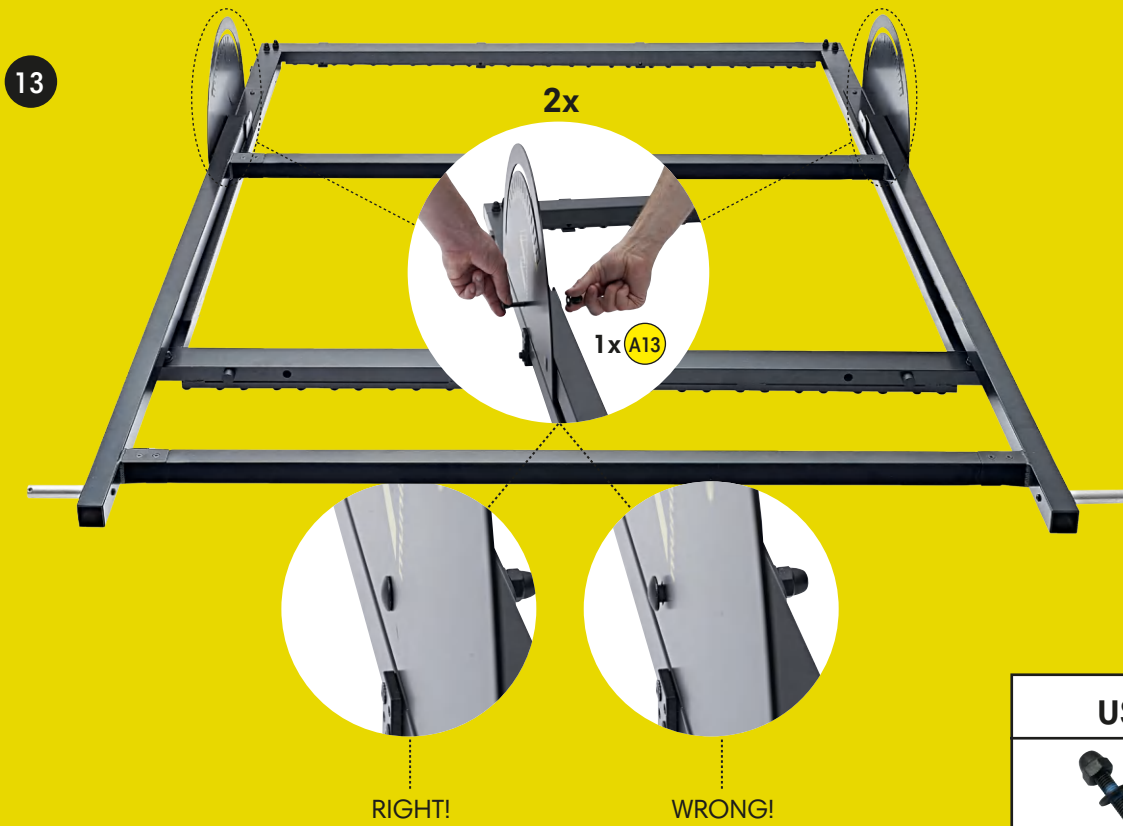
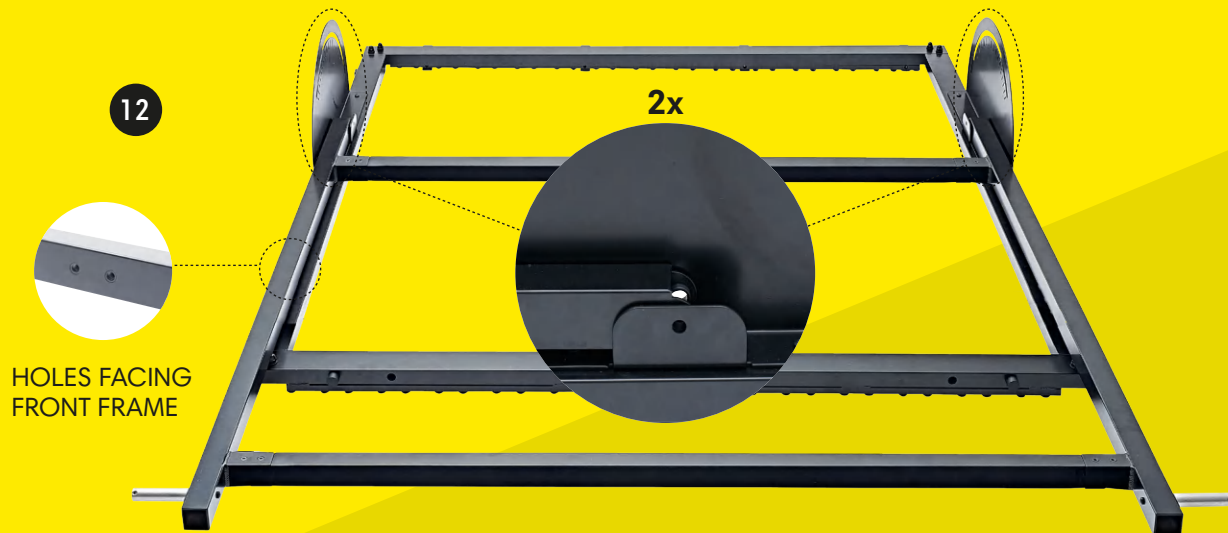

# FRONT- & BACK FRAME

14

2x

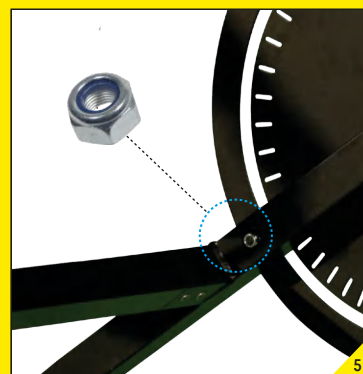

**IMPORTANT!**  
 Plastic  
 Plastic  
 Metal

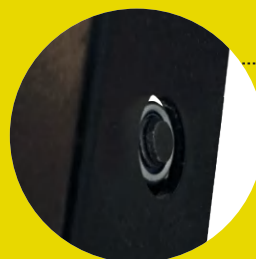

RIGHT!



WRONG!

# NET

15

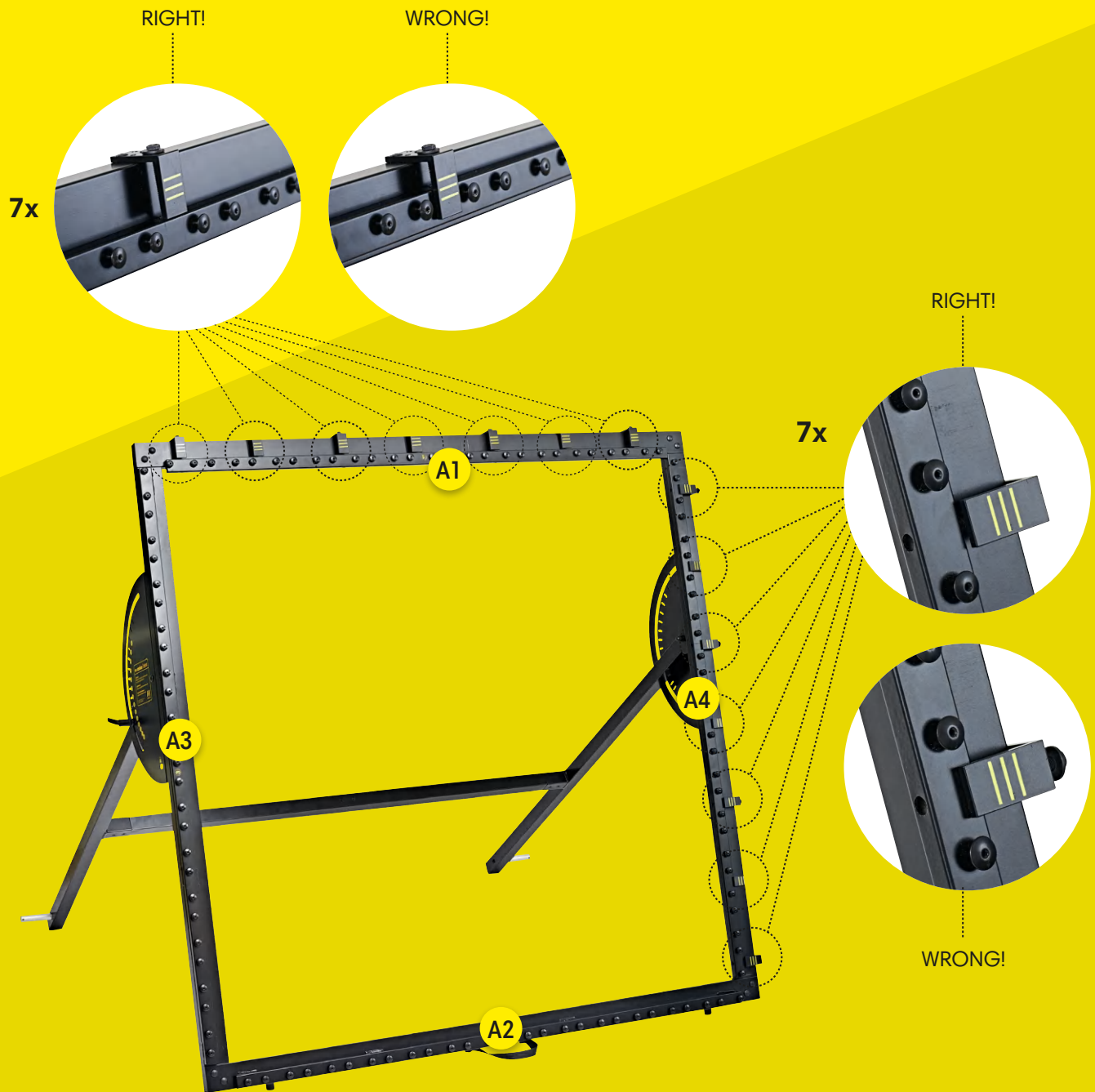

# NET

16

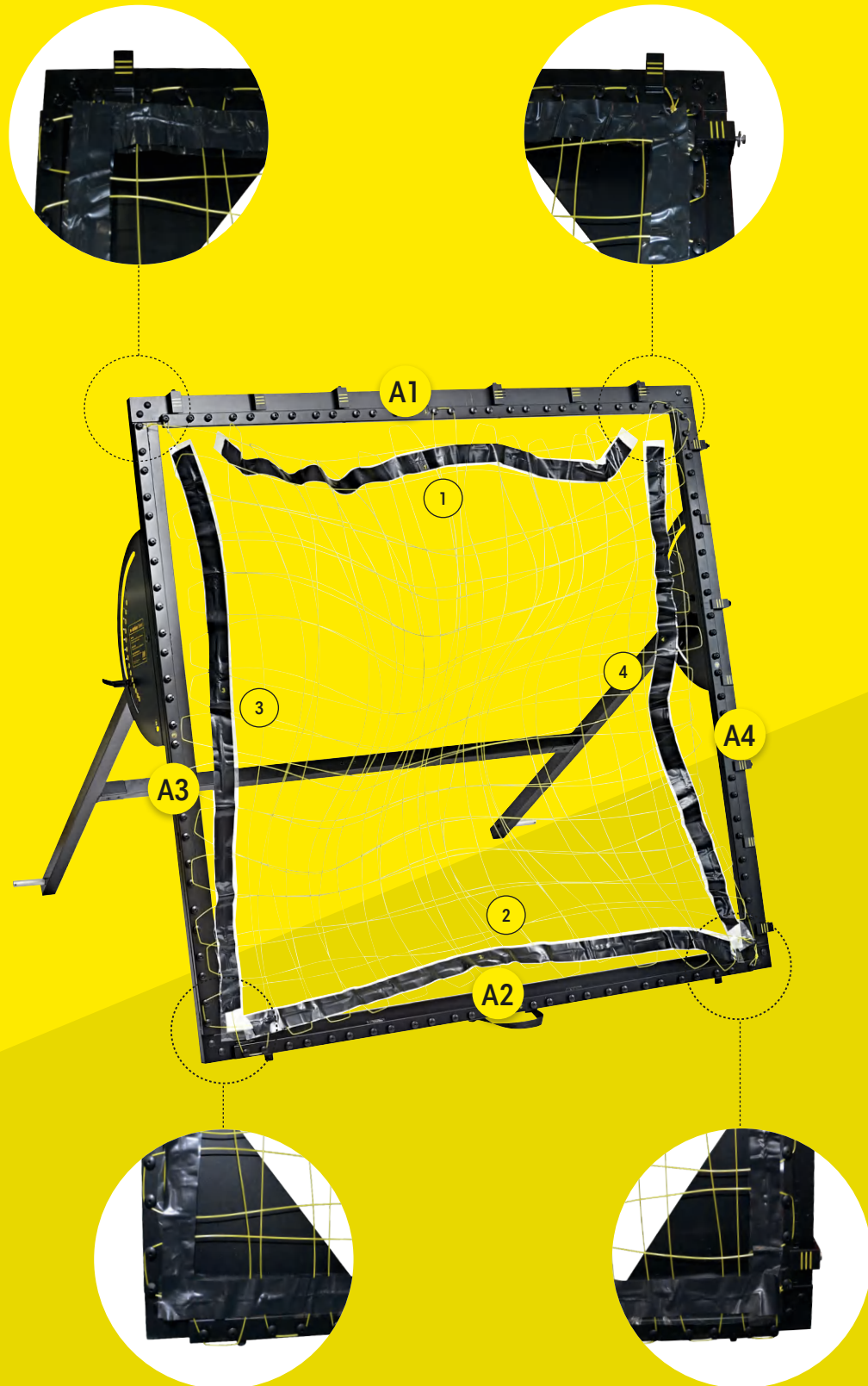



# NET

17

RIGHT!



WRONG!

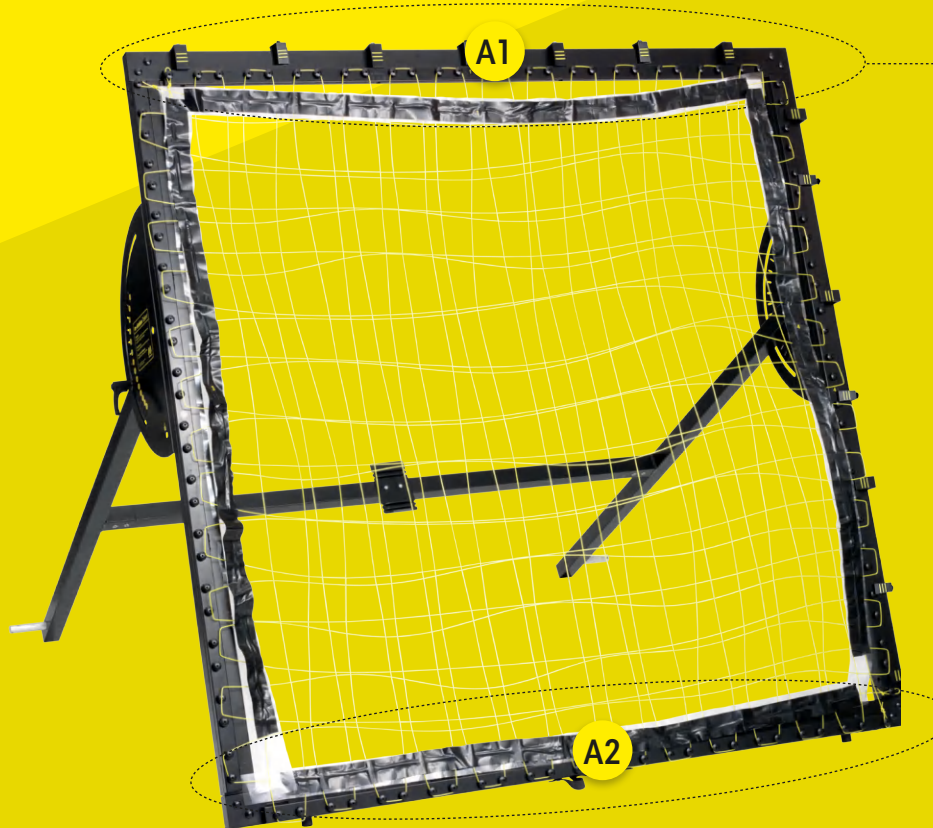

# NET

18

7x

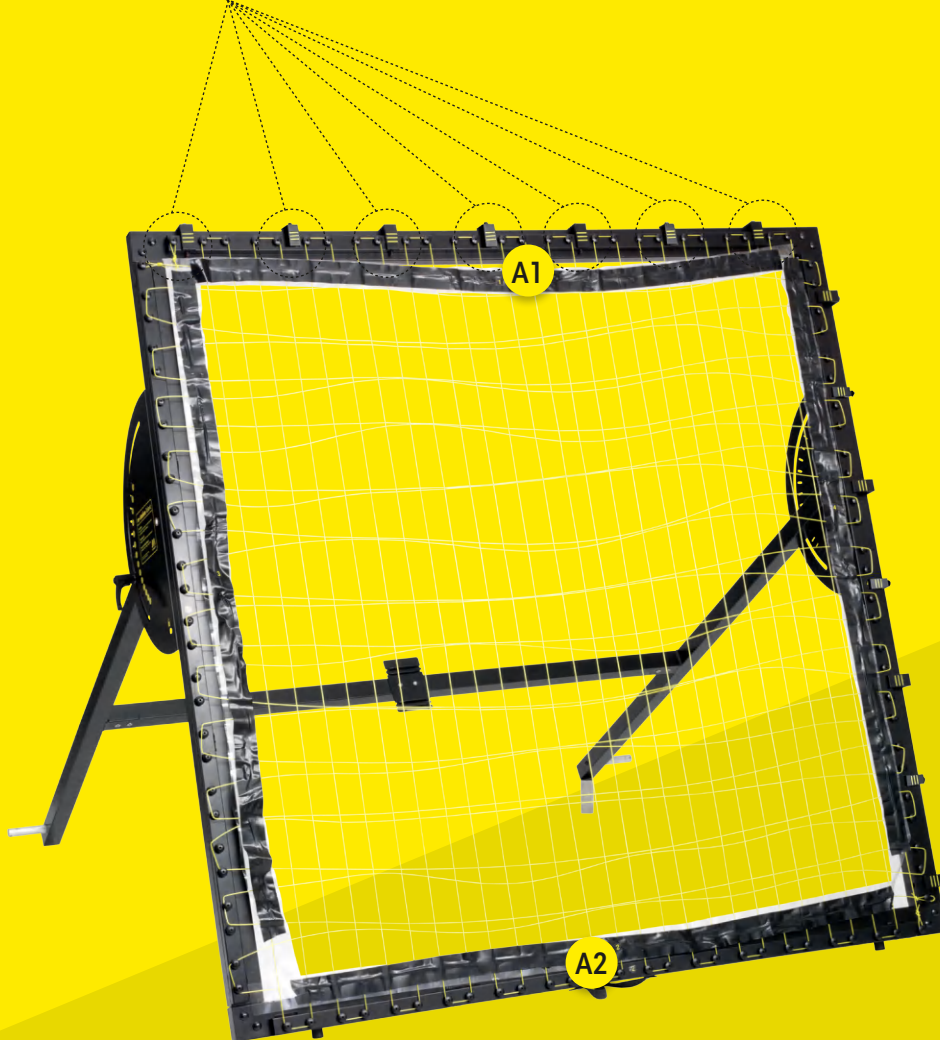
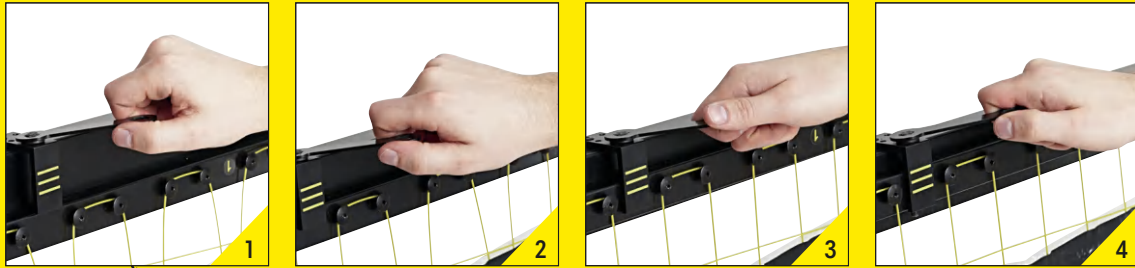

RIGHT!



WRONG!





# NET

19

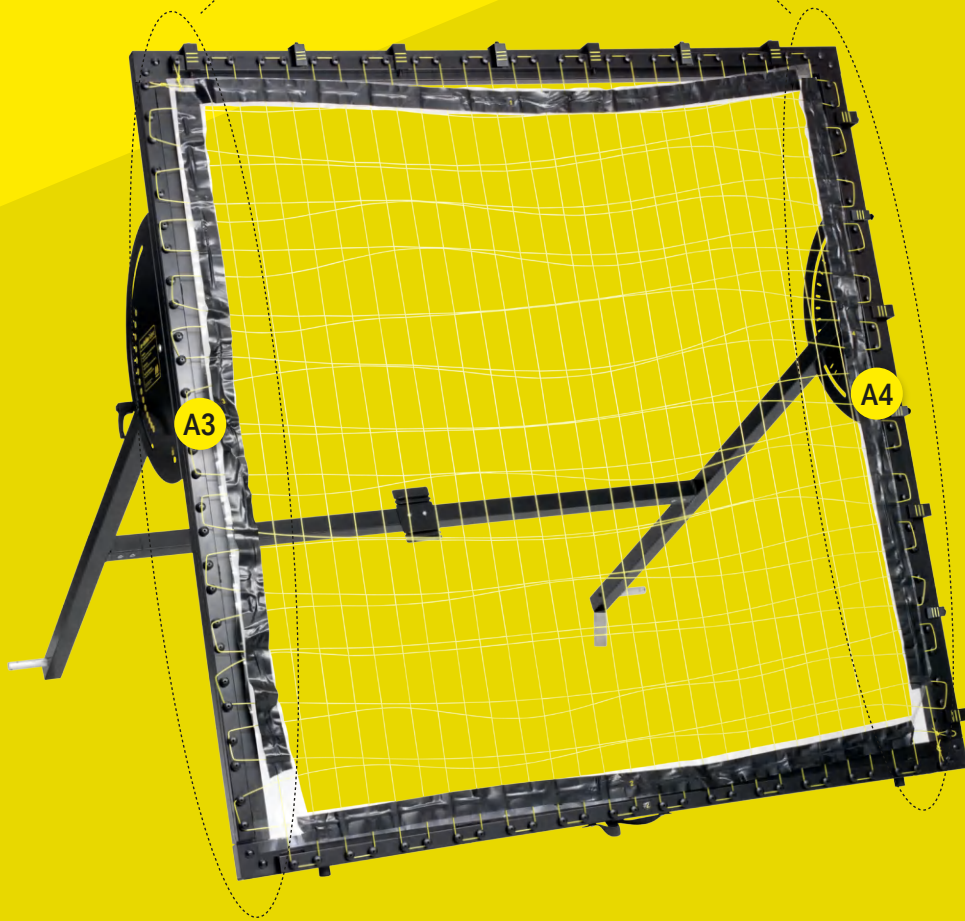

RIGHT!

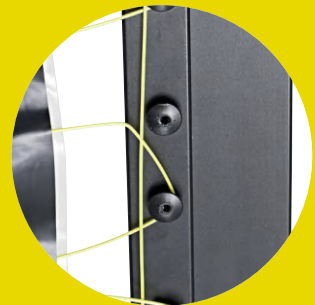

WRONG!



# NET

20

RIGHT!



WRONG!

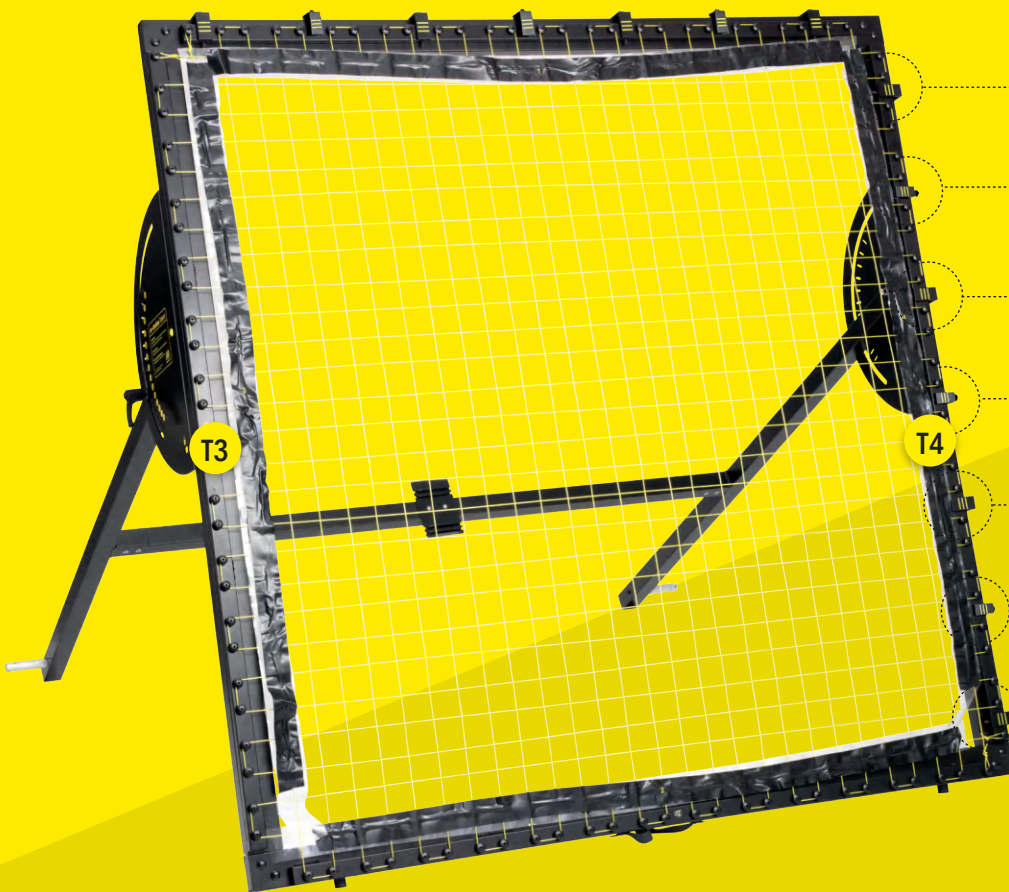
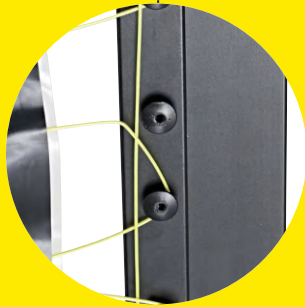

7x

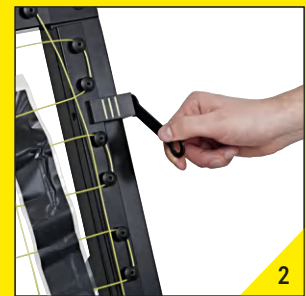

**DO NOT USE**



# NET

21

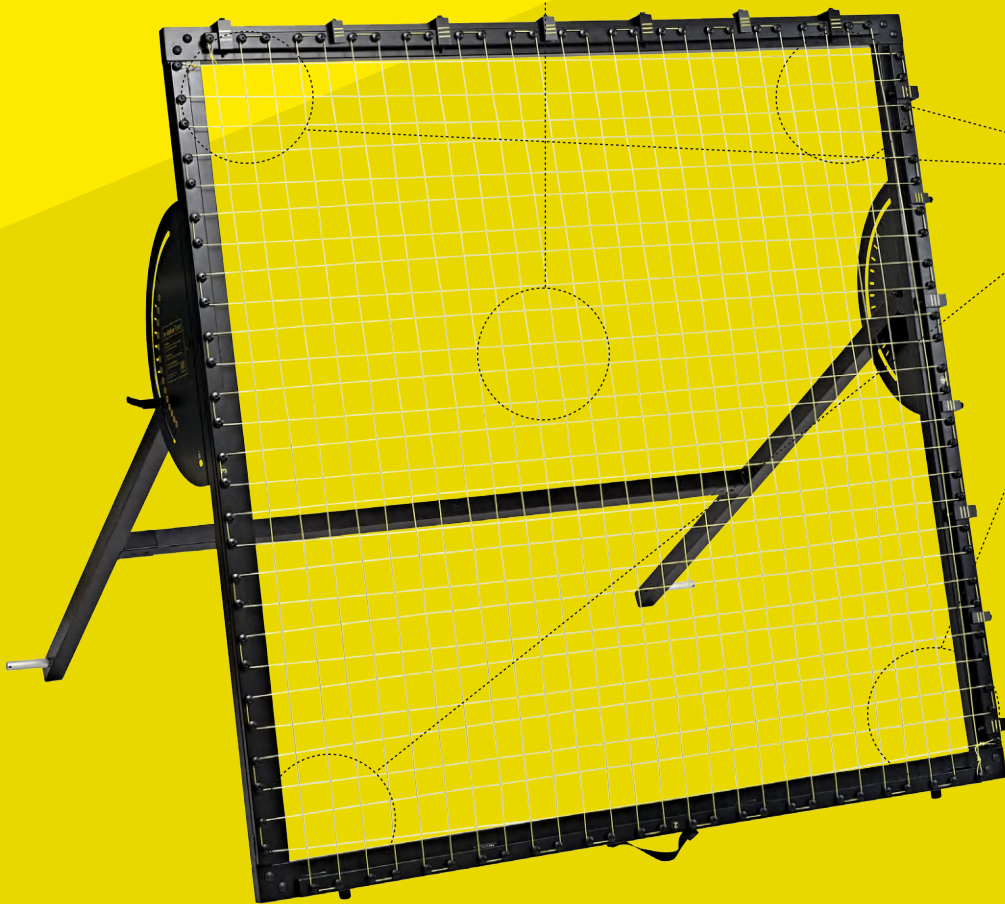

4x

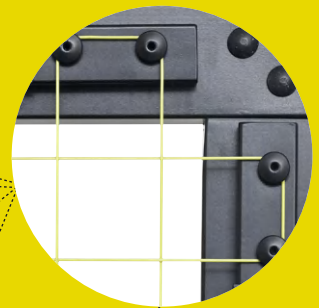

RIGHT!

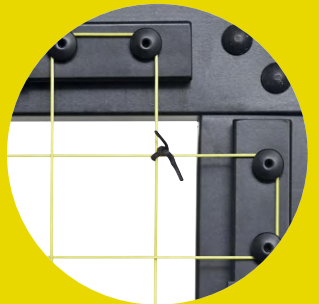

WRONG!



# NET

22

2x

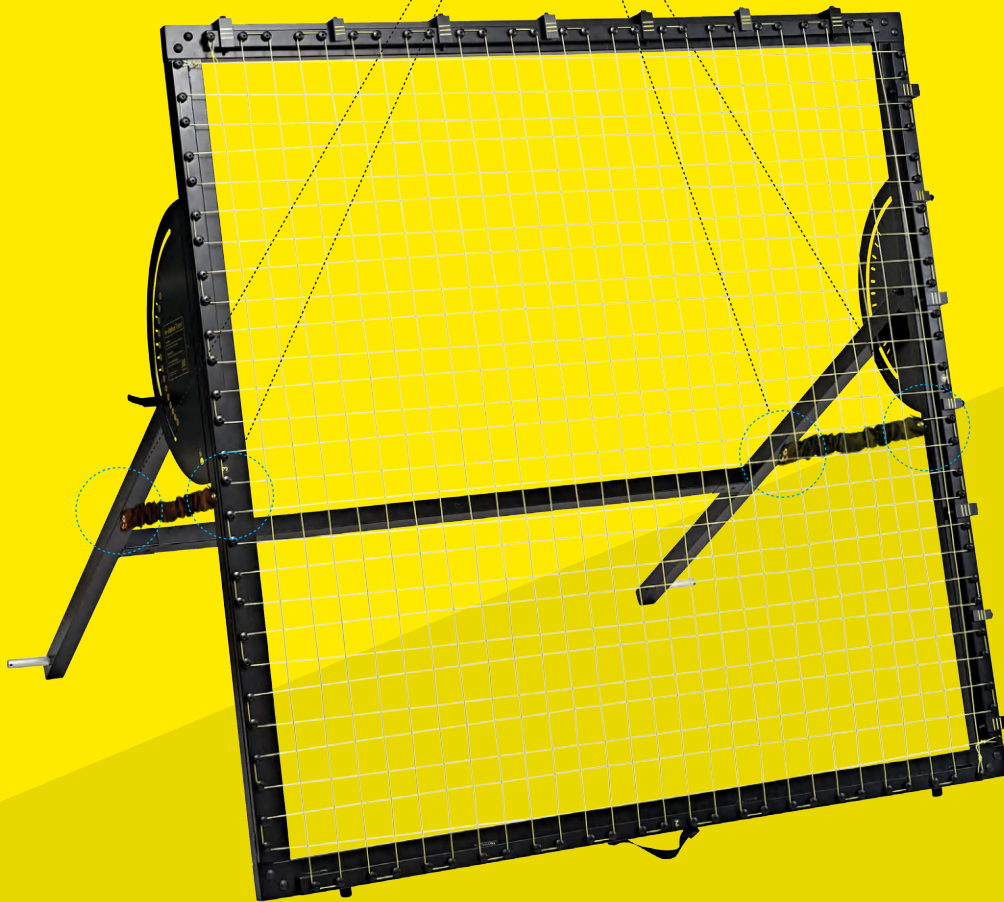
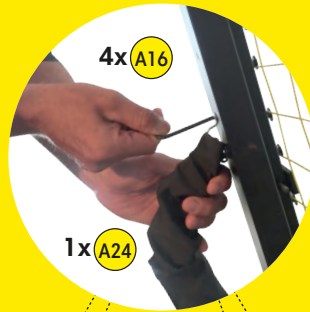



USE	USE
	
2x A24	8x A16

# WHEEL

23

2x





USE	USE
	
2x (A17)	2x (A10)

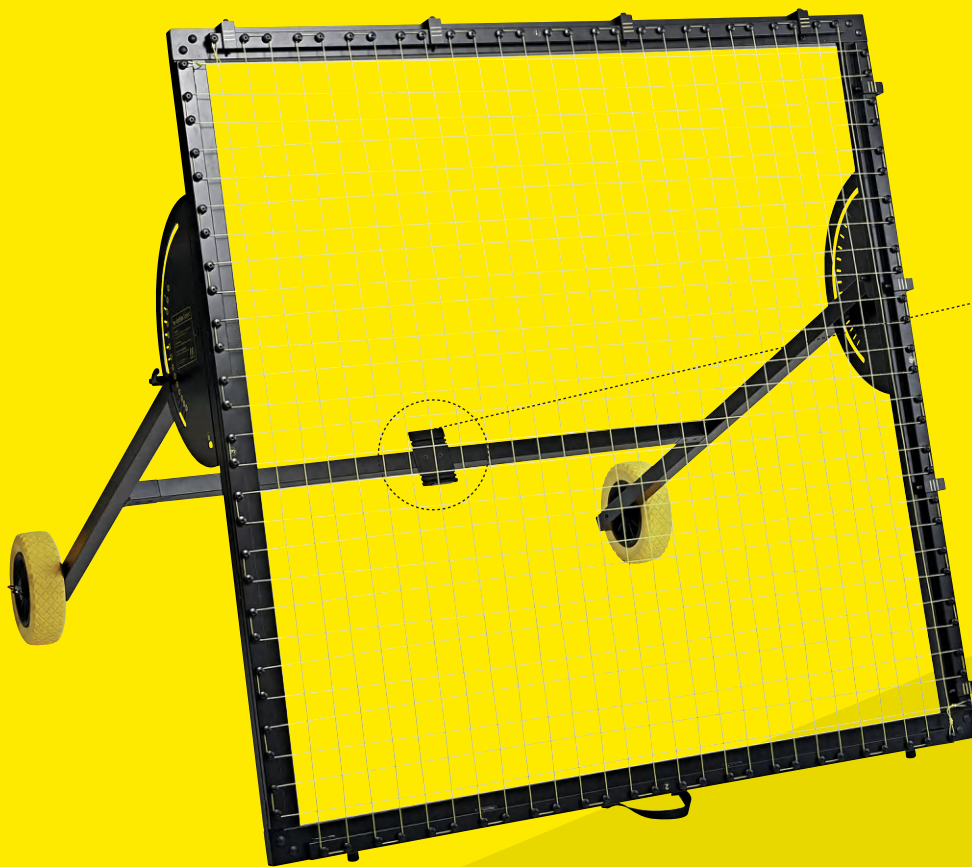

# SMARTPHONE HOLDER

24



USE	USE
	
2x (A19)	8x (A11)

# THE M-STATION PRODUCT RANGE

---

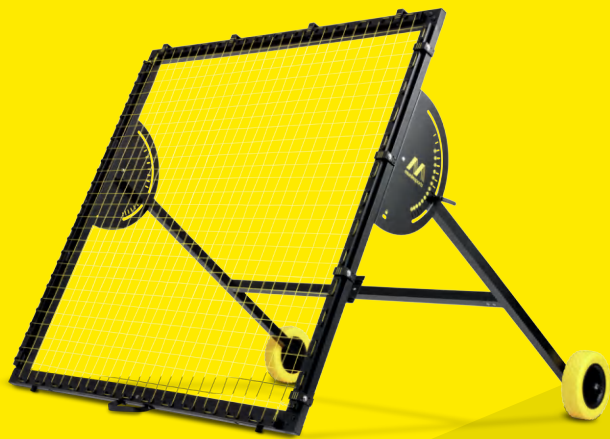

## Original edition

m-station Talent and the MuninPlay app are the only training system in the world to measure your technical skills. The MuninPlay app transforms your smartphone into your own personal coach and your backyard into a world class training facility.



## Basic edition

The great match between functionality and price. It has the patented string system with the superior rebound effect that has made the m-station family known as the best rebounders in the world. And it has a basic rear construction with two inclination settings. One for flat passes and one for high passes.

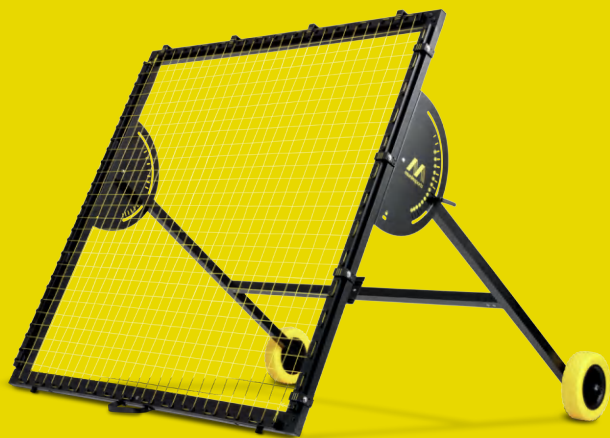

## Club edition

We have taken the original m-station Talent and given it an even stronger body. Reinforced aluminum parts and stronger nuts and bolts make the Club Edition perfect for hours of daily use in clubs and academies.

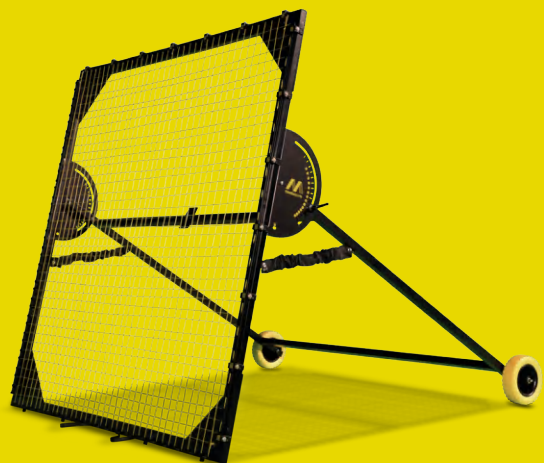

## Academy edition

If you want your players to develop their technical skills faster, the m-station Academy is your choice. Increased size and durability. The m-station is used by Real Madrid, Chelsea, Manchester United, Bayern München, Arsenal, and many more.

# GET STARTED WITH MUNINPLAY



**1. DOWNLOAD THE APP**  
the MuninPlay app is free and works with Android and iOS

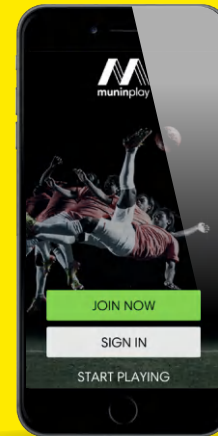

**2. CREATE PROFILE OR START PLAYING**  
Place your phone in the cradle behind the net on your m-station

## 108 SOCCER DRILLS



You can develop your skills much faster if you can measure how capable you are. If you know how quick you are on your feet, if you know how accurately you shoot, if you know how well you control the ball. MuninPlay makes it possible and gives you a unique insight into your skills.

There are 108 drills in MuninPlay, covering everything necessary to turn you into a complete soccer player. From passes, dribbles and first touches to finishing and speed. Each drill is illustrated with easily accessed practice cards and introductory videos. Watch in detail how to do each of the soccer training drills and see how to position m-station, cones and the goal to get the best result.



# PROFILE & STATS



With MuninPlay you get your own soccer profile. It will tell you how much you have practiced, what drills you have completed

and where your strengths are. It will provide you with lots of fun and inspirational data on your individual soccer skills.

# VIDEOS

Watch in details how to do each of the football training drills and see how to position m-station, cones and the goal to get the best result.



# SOCIAL

Find your friends in MuninPlay and check out their latest activities in the friends feed. Select the multiplayer option to compete with your friends and family at home or challenge them online.



# HOW MUNINPLAY WORKS

---

## 1. CHOOSE DRILL

Open MuninPlay on your phone and select the drill you want

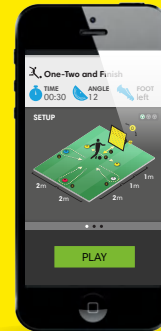

## 2. MOUNT THE PHONE

Place your phone in the cradle behind the net on your m-station

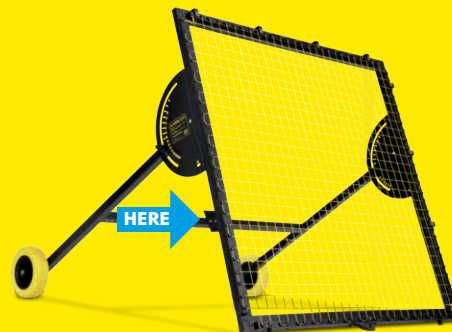

## 3. START PLAYING

Let the fun begin and play alone or with friends



## 4. VIEW STATS

View the stats on your performance and progression



# MUNINPLAY FEATURES

---



## PROFILE & STATS

Get your very own complete player profile. MuninPlay will tell you everything about your skills and your speed.



## VIDEO

Watch in detail how to make each drill and see how to position m-station, cones and goal to get the best result.



## TRAINING DRILLS

More than 100 drills covering everything necessary to turn you into a complete soccer player.



## REAL TIME AUDIO

Your personal coach shouts encouragements and thousands of spectators cheer you on as you perform.



## CHALLENGES

Challenge your friends directly from the app - even if you are standing in separate yards.



## NEWS FEED

Receive updates about your friends and see how much they have practiced, their high scores and much more.



## MULTIPLAYER

Play with your friends and family in your garden. MuninPlay crowns a winner after each game.



## RESULTS & RANKING

MuninPlay keeps track of your best results in each drill so you can compare your progress with your friends.

# GET INSPIRATION



## WHICH FOOTBALL STAR COULD YOUR CHILD BECOME?

**NEXT11.COM HOLDS THE ANSWER**

Based on height, weight, age, and position, the Next11 star-database will find four of the best players in the world who match your profile in terms of adult height and position on the pitch. Next11 will release your star potential with a tailored and free 15-week training program with super-cool position-specific video drills.

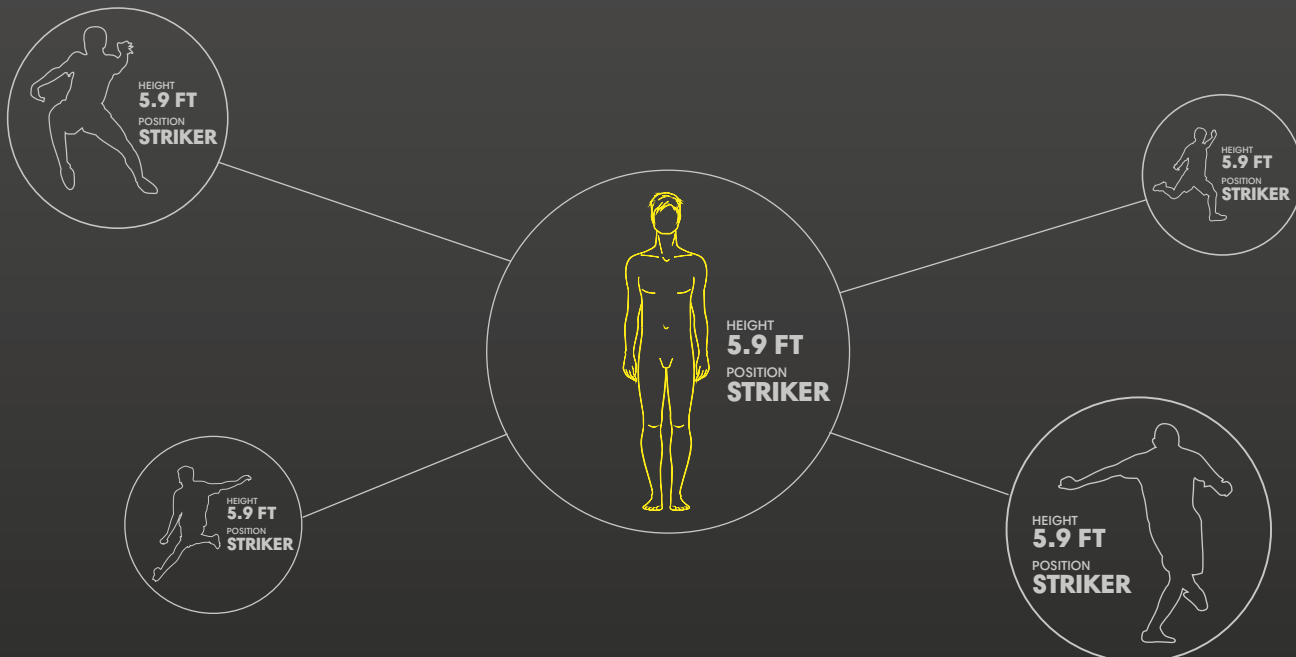
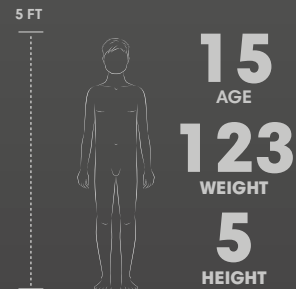

## DIVE



SPEED



PACE

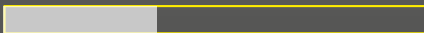

STAMINA



## FINISH WITH VOLLEY



SPEED



PACE

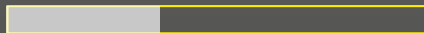

STAMINA

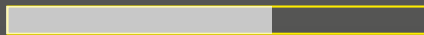

## CRUYFF TURN



SPEED



PACE

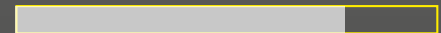

STAMINA

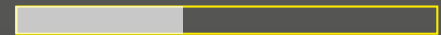

N  
NEXT 11



Niklas  
FC Horsens

15 CM 157  
Age Position Height

Your videos

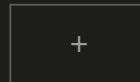

My boot  
Nike Viper

My favorite club  
Liverpool

My favorite player  
Iniesta

Next11  
boot ranking

PROFILE

TRAINING PROGRAM

ALL CREDS

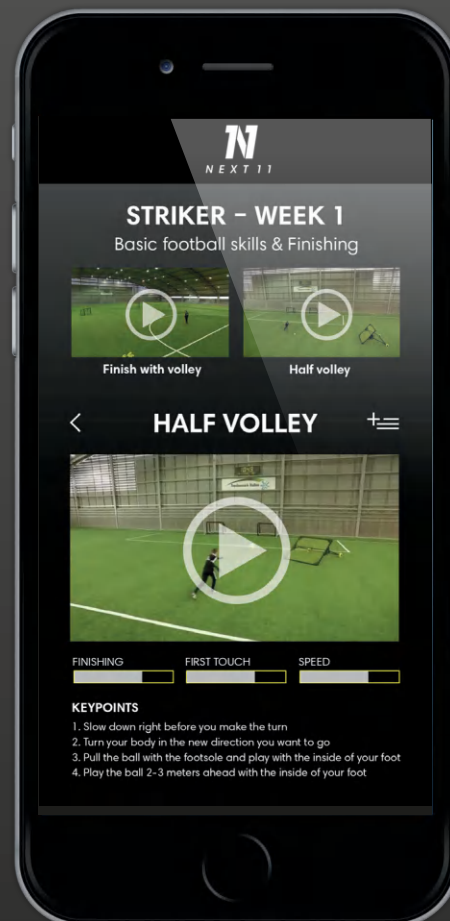

N  
NEXT 11

STRIKER - WEEK 1  
Basic football skills & Finishing



Finish with volley



Half volley

HALF VOLLEY



FINISHING FIRST TOUCH SPEED

KEYPOINTS

1. Slow down right before you make the turn
2. Turn your body in the new direction you want to go
3. Pull the ball with the footsole and play with the inside of your foot
4. Play the ball 2-3 meters ahead with the inside of your foot



## HOW TO SELECT TYPE OF PASSES

Untighten the handles in each side, choose the angle and tighten the handles firmly when the new angle is decided.

- Select 0:** Receive passes along the ground!  
**Select 1-12:** Receive passes in the air. The higher the number the higher the passes!



Munin Sports is not responsible for injury or damage to persons or property resulting from incorrect assembly of m-station. m-station is a training apparatus developed for professional football training. m-station must therefore never be used by children under the age of 12. Particular attention is drawn to the fact that small children, if m-station is not used in accordance with instructions, risk becoming trapped in the assembled netting. m-station must not be assembled, dismantled, moved or otherwise handled by a children. m-station must only be used for the exercises explicitly presented on [www.muninsports.com](http://www.muninsports.com). When adjusting the angle of m-station make sure to keep all bodyparts away from any moving parts of the product. Munin Sports disclaims all responsibility for injury and damage to persons or property caused during storage, exercises or other use being undertaken deviating from or in contradiction to the use presented on [www.muninsports.com](http://www.muninsports.com). Storage or use of m-station deviating from or in contradiction of instructions for use takes place at the user's own risk. Never make any changes to the product or use any sparepart not provided by Munin Sports. Review and tighten all screws and bolts every 2nd month.

