

M-STATION TALENT

# **ASSEMBLY MANUAL**



# ASSEMBLY CHAPTERS

---

<b>Parts &amp; Tools</b>	Page	3
<b>1. Front Frame</b> (step 1-7)	Page	4
<b>2. Back Frame</b> (step 8-9)	Page	8
<b>3. Front- &amp; Back Frame</b> (step 10-12)	Page	9
<b>4. Net</b> (step 13-19)	Page	11
<b>5. Wheels</b> (step 20)	Page	18
<b>6. Phone Holder &amp; MuninPlay app</b> (step 21)	Page	19

## Get involved

Upload your #mstation videos and images



# PARTS & TOOLS

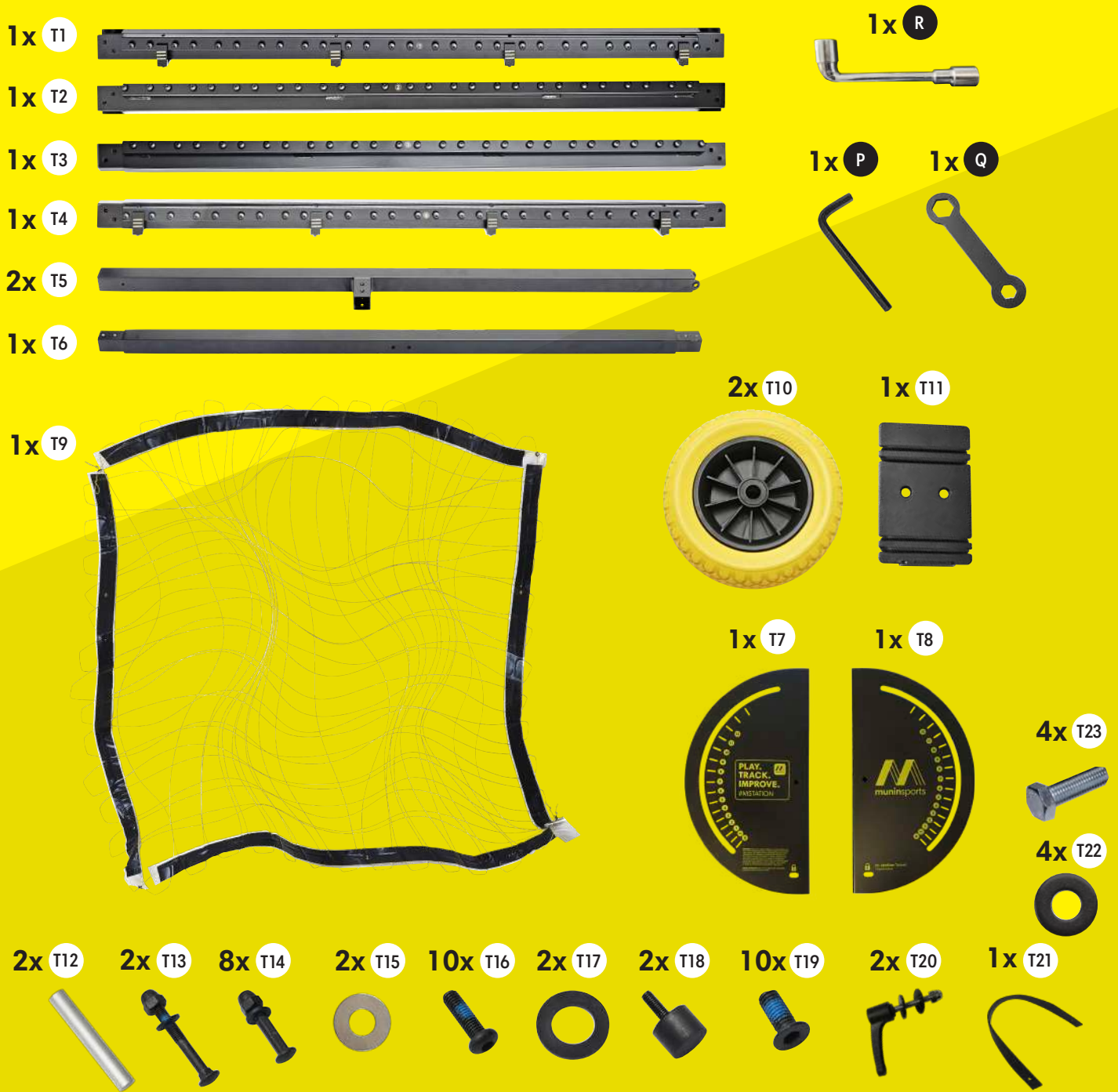

- 1) Make sure that all of the parts are included in the package before you start assembling the m-station Talent. Please, be aware that the color of the parts may differ from the color of the depicted parts in the manual.
- 2) If any of the parts are missing or damaged please contact us at [service@muninsports.com](mailto:service@muninsports.com). If any of the parts are damaged please attach a photo in the e-mail.
- 3) You need a rubber mallet/hammer (not included). Do not use a regular hammer or pliers.

# FRONT FRAME

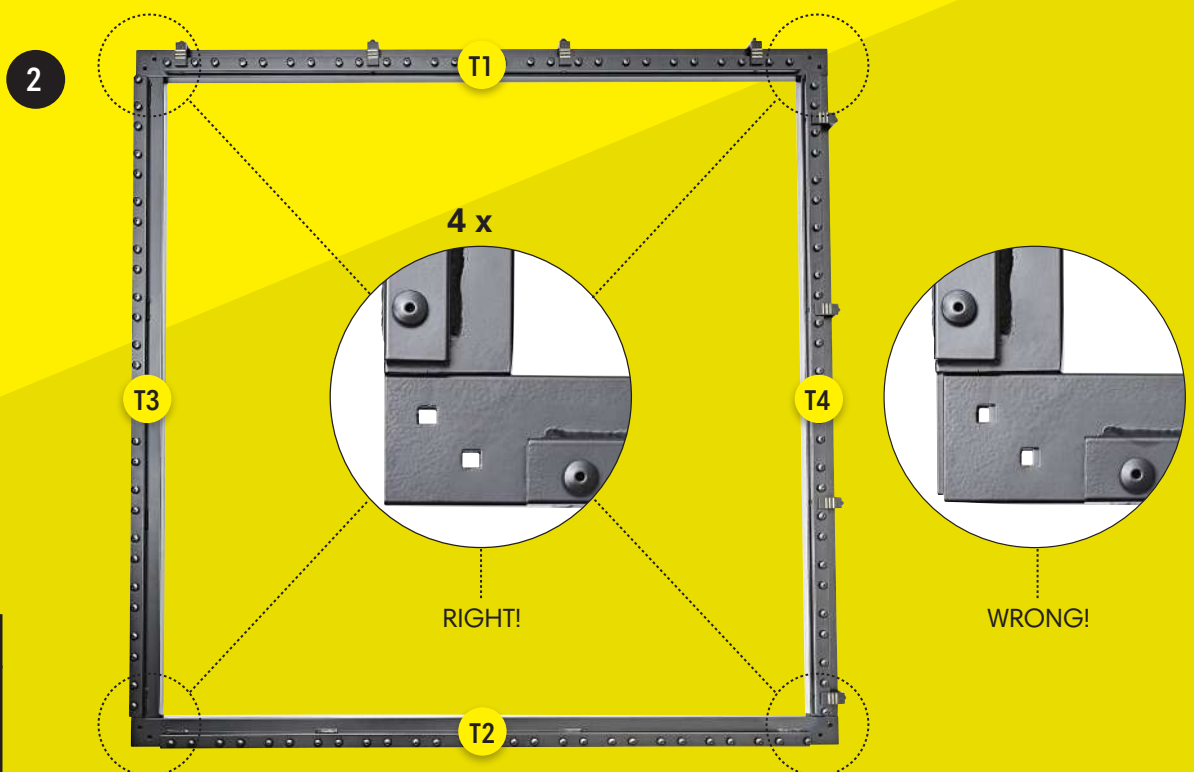
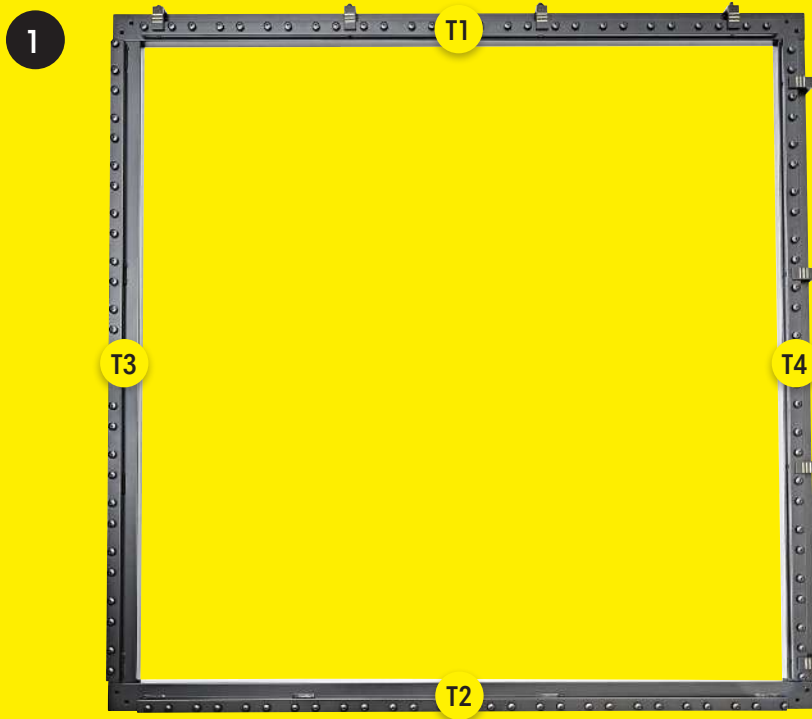

USE IF NECESSARY



# FRONT FRAME

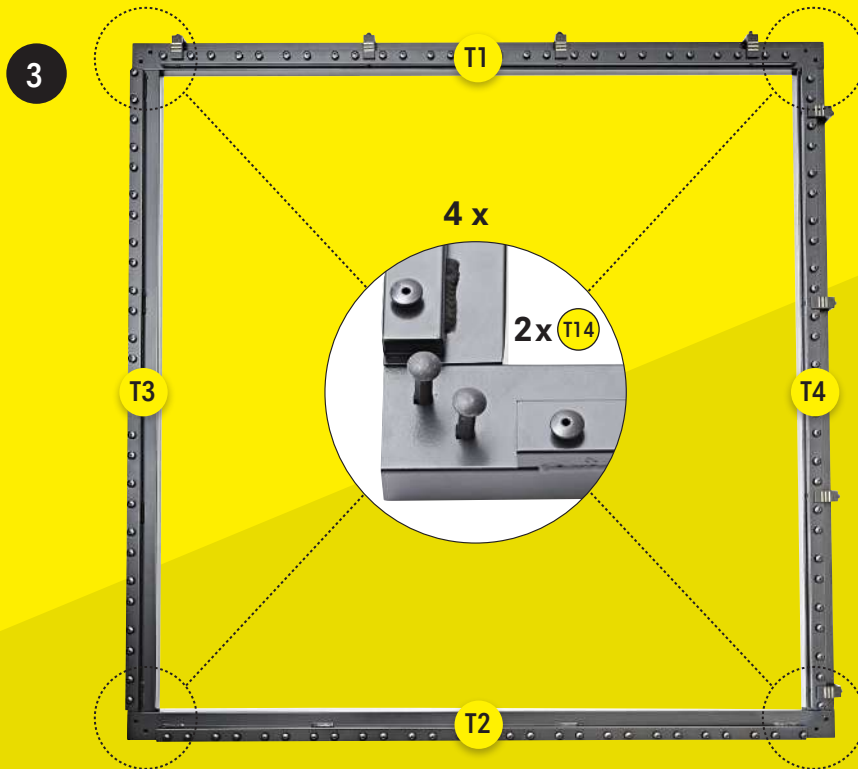

# FRONT FRAME

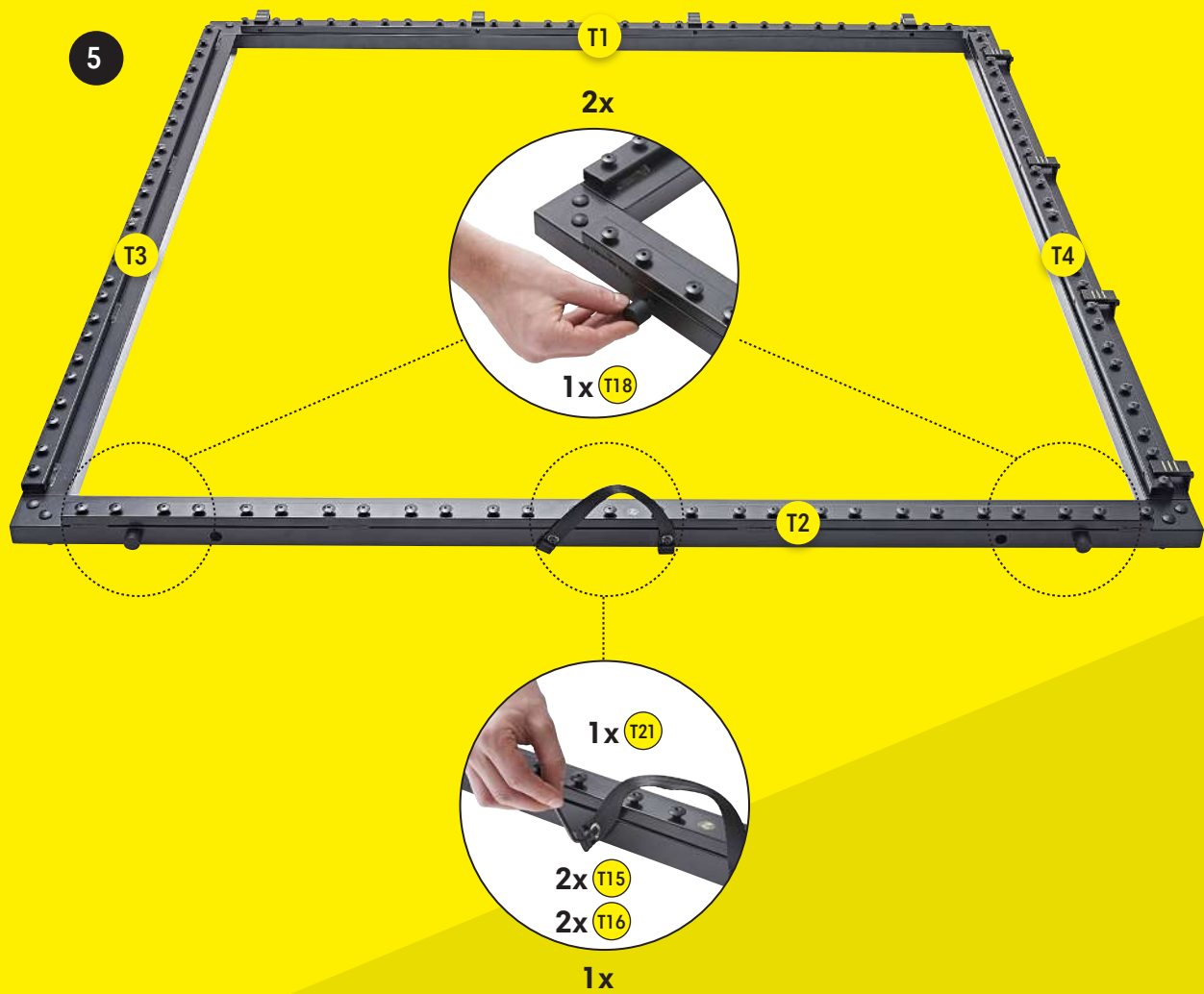

USE	USE	USE	USE
<b>1x T21</b>	<b>2x T15</b>	<b>2x T18</b>	<b>2x T16</b>

# FRONT FRAME

6

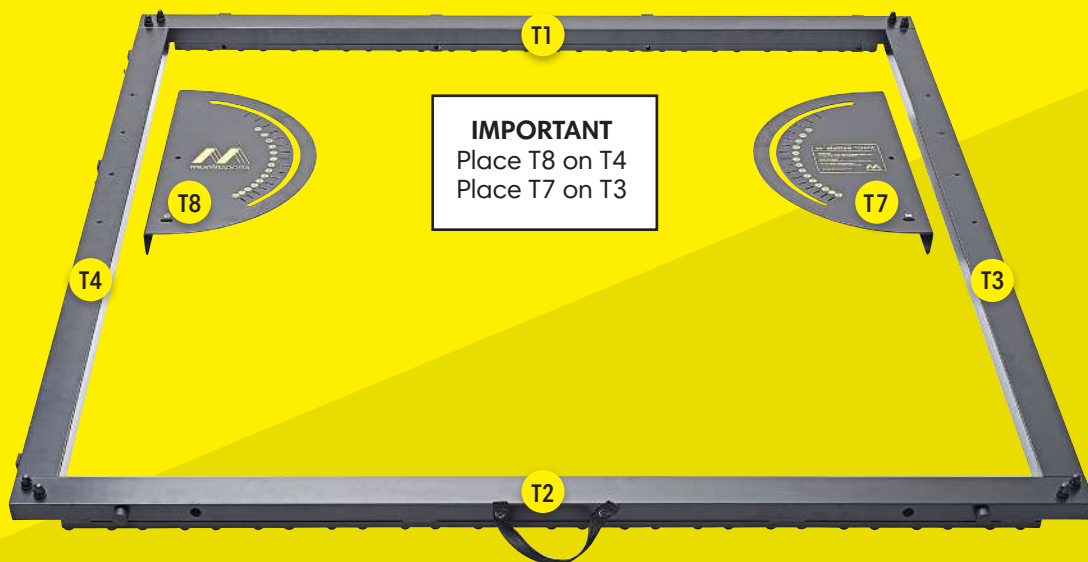

7

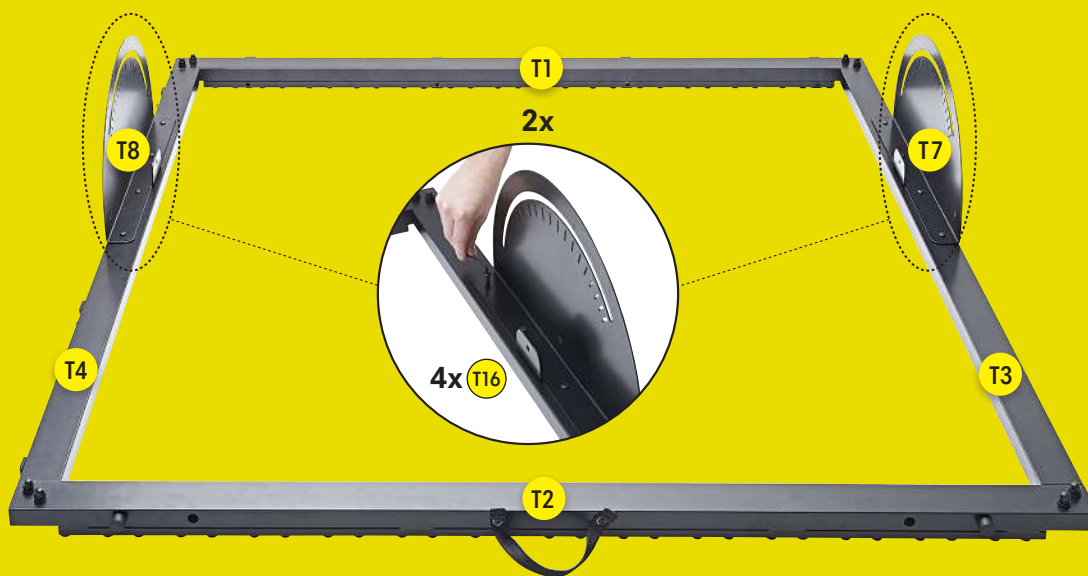



# BACK FRAME

8

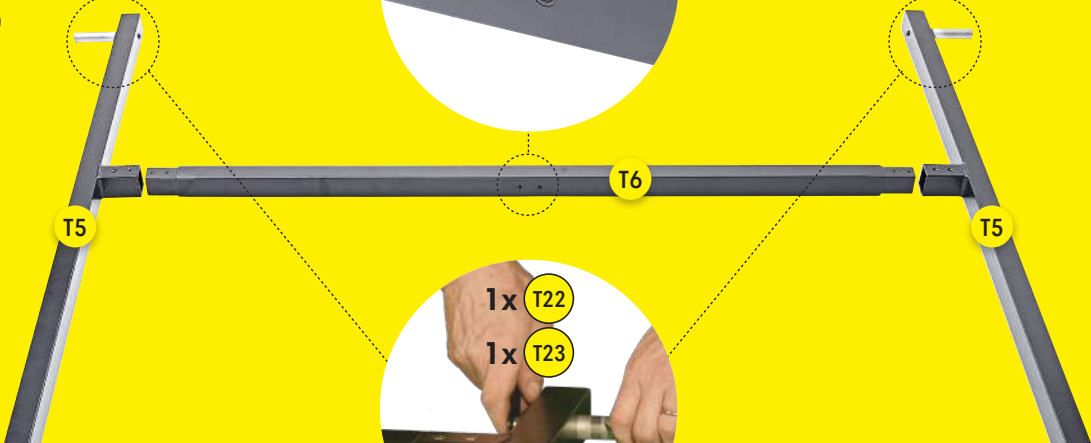

**IMPORTANT**  
Holes pointing  
in the opposite  
direction of T12



USE	USE
	
2x T12	2x T23

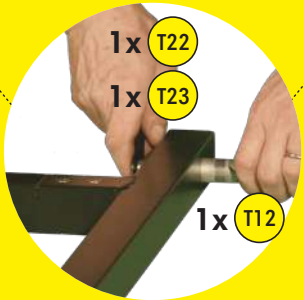

2x

USE

2x T22 Metal

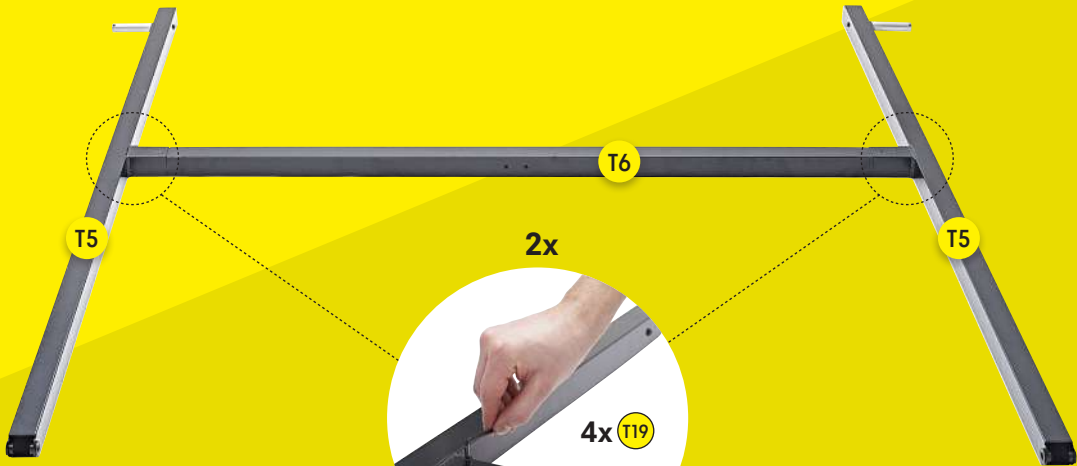
9



2x



4x T19

USE

8x T19



# FRONT- & BACK FRAME

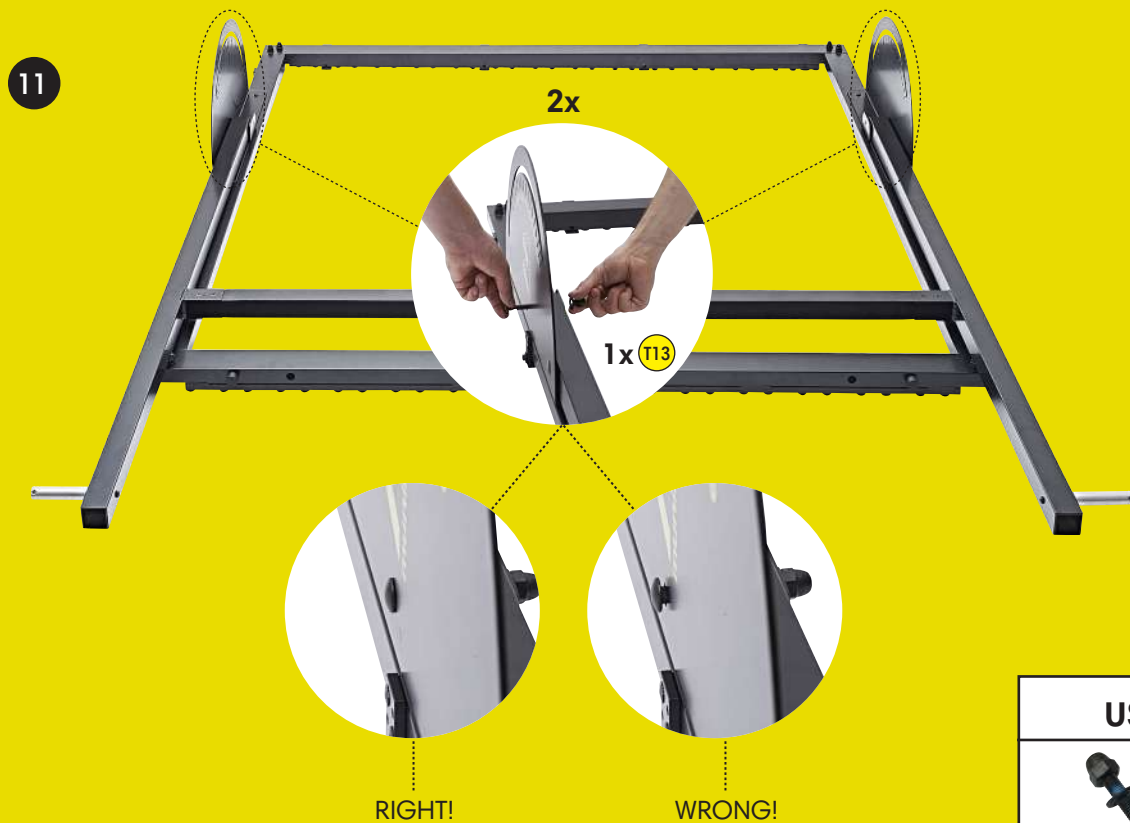
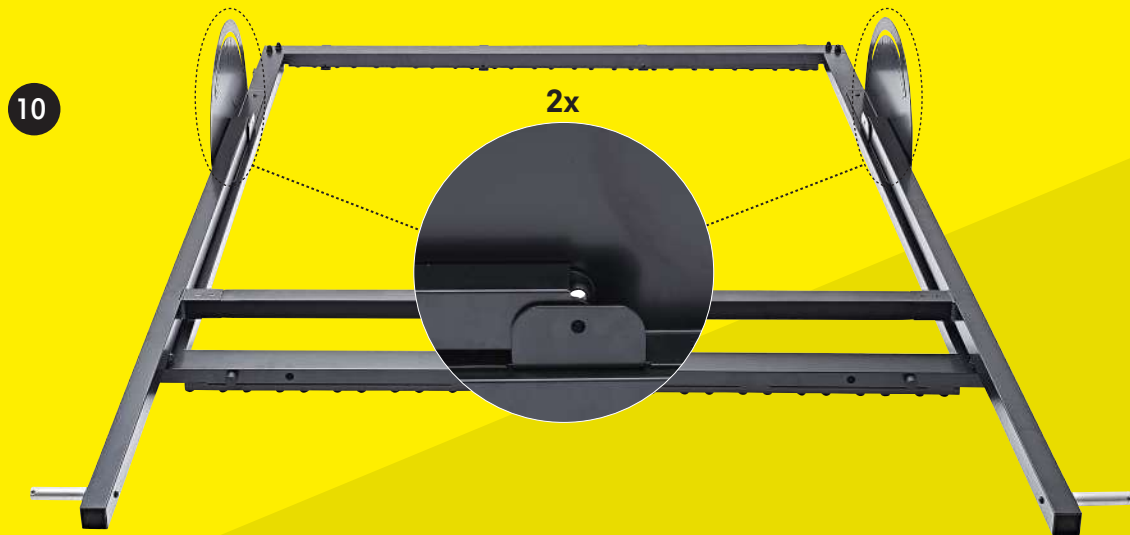

# FRONT- & BACK FRAME

12

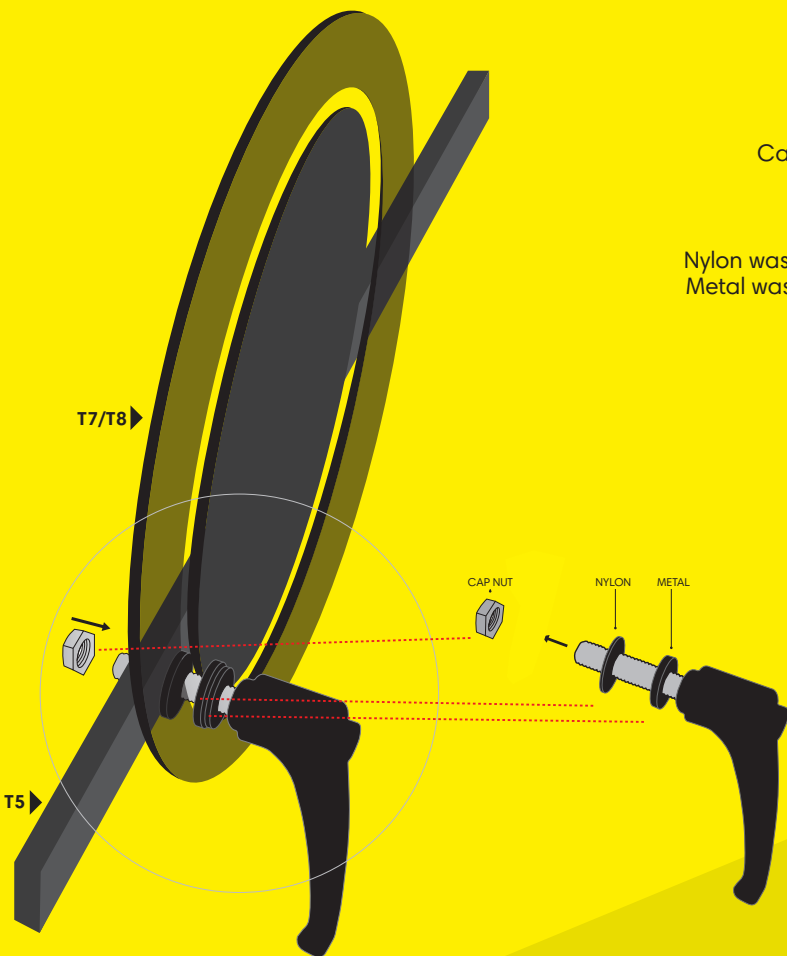

2x

Cap nut

Nylon washer  
Metal washer



Tighten cap nut



**USE**

2x T20

**IMPORTANT!**  
Cap nut  
Nylon  
Metal

# NET

13

WRONG!



RIGHT!



**IMPORTANT**  
Start by untightening the 4 screws until the bar is positioned as shown

4x

RIGHT!



4x

WRONG!

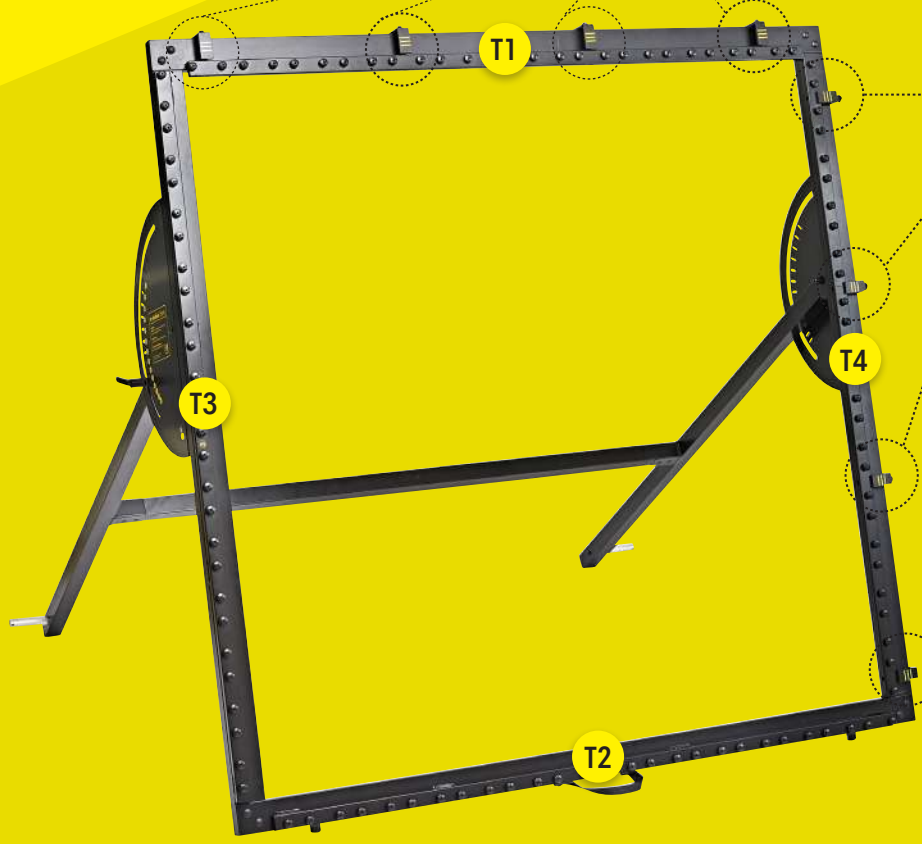

# NET

14



# NET

15

RIGHT!

WRONG!

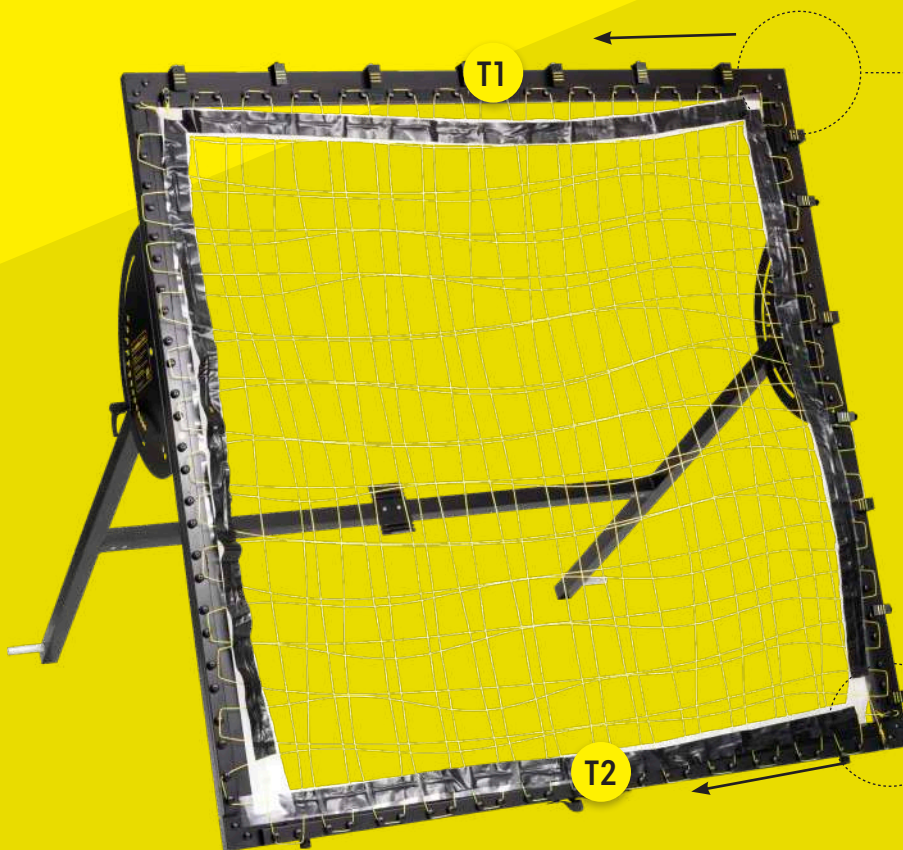

# NET

16

4x



**IMPORTANT**  
Tighten until the top of the bar is aligned with the top yellow line

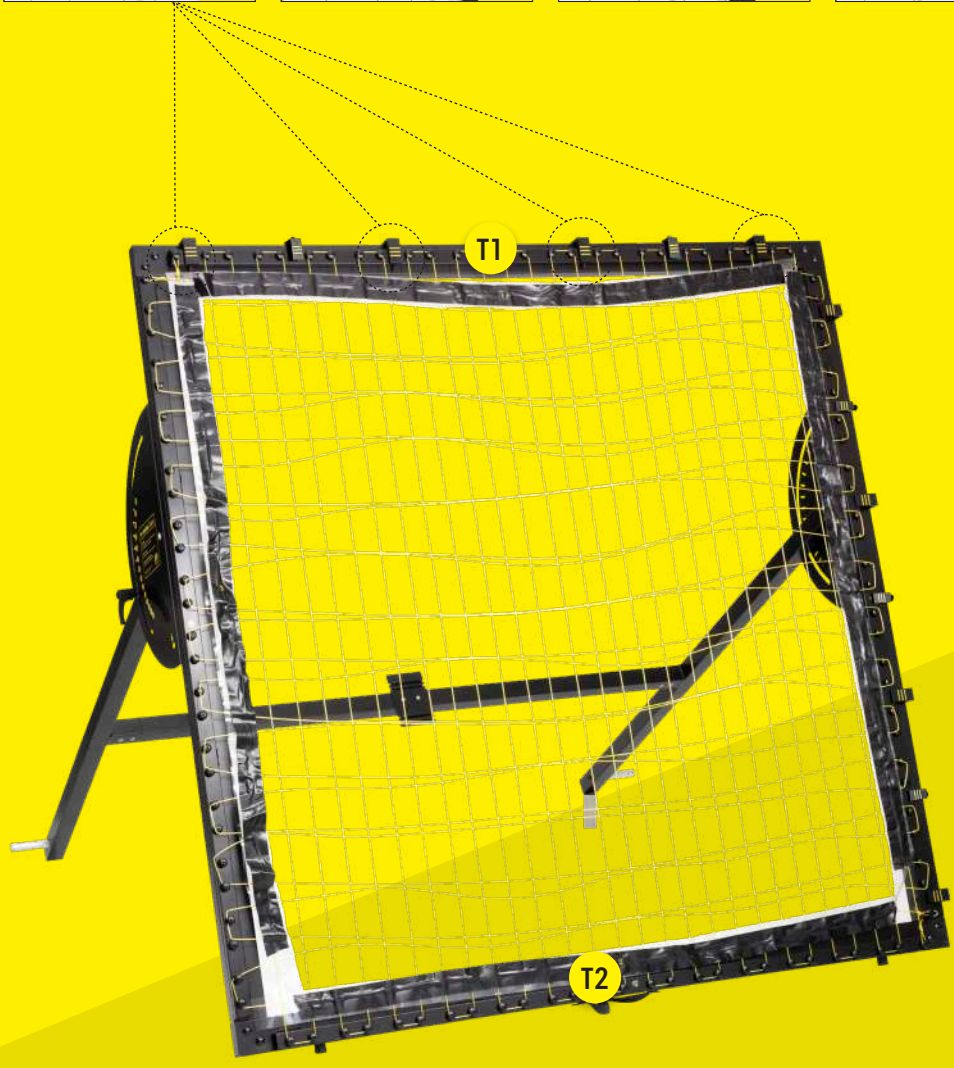

# NET

17

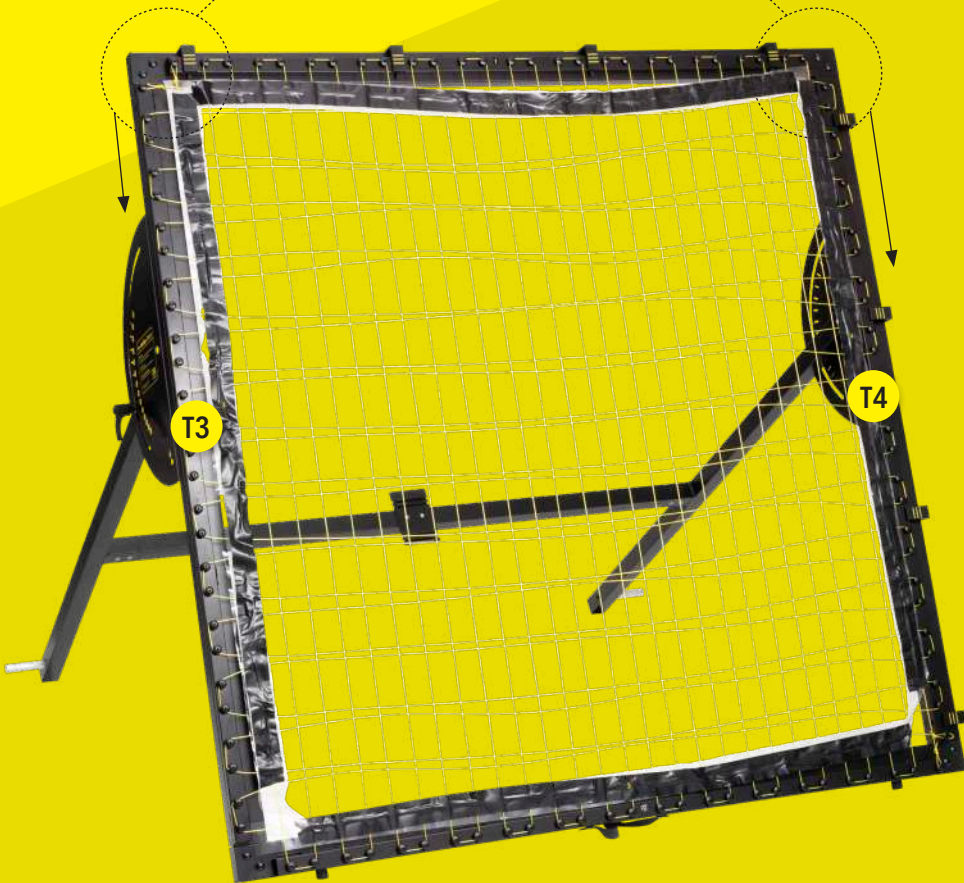

RIGHT!



WRONG!



# NET

18

RIGHT!



WRONG!

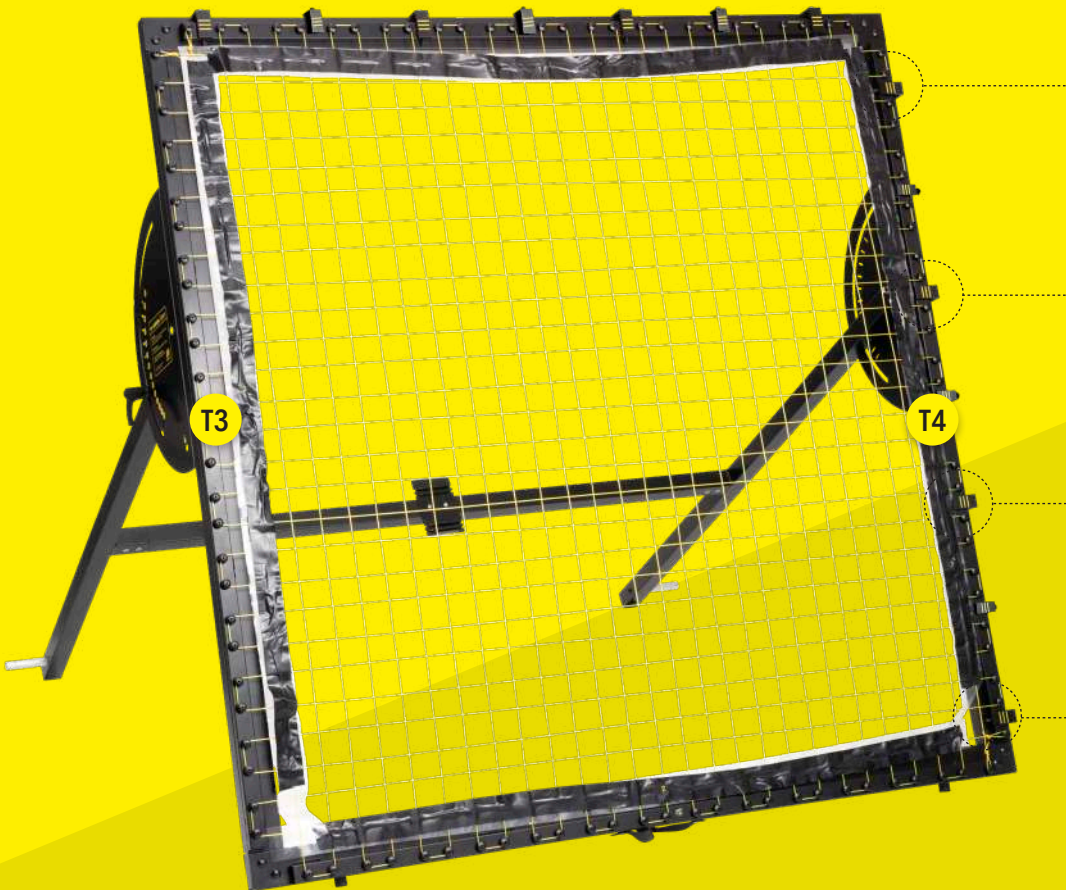

4x



**DO NOT USE**



**IMPORTANT**

Tighten until the bar is aligned with the outer yellow line



# NET

19



REMOVE TAPE

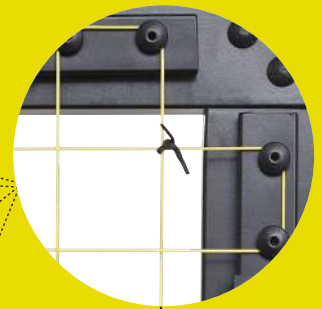
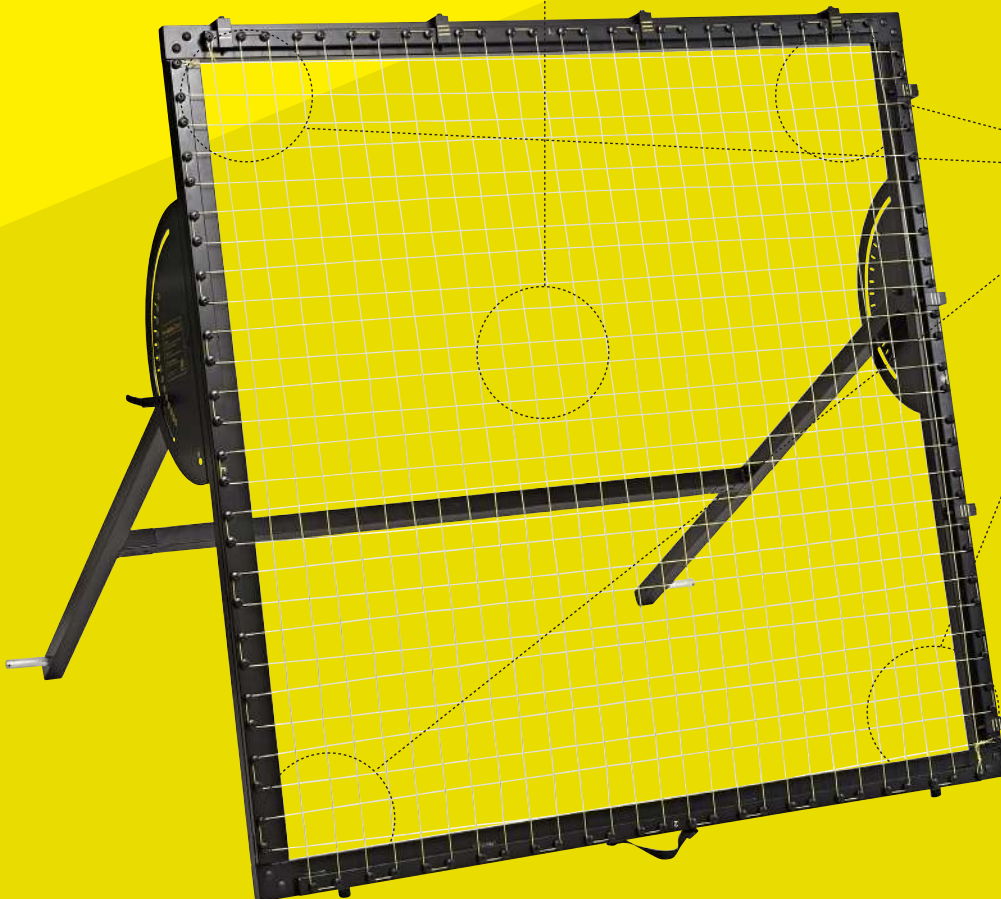

4x

REMOVE PLAST STRIPS

**DO NOT USE**





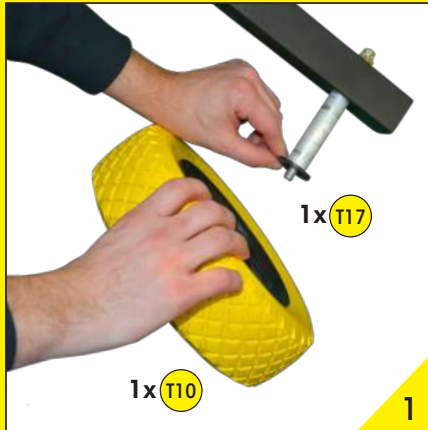

# WHEELS

20

2x



USE	USE	USE	USE
			
2x T17 Plastic	2x T10	2x T22 Metal	2x T23

# PHONE HOLDER & MUNINPLAY APP

21

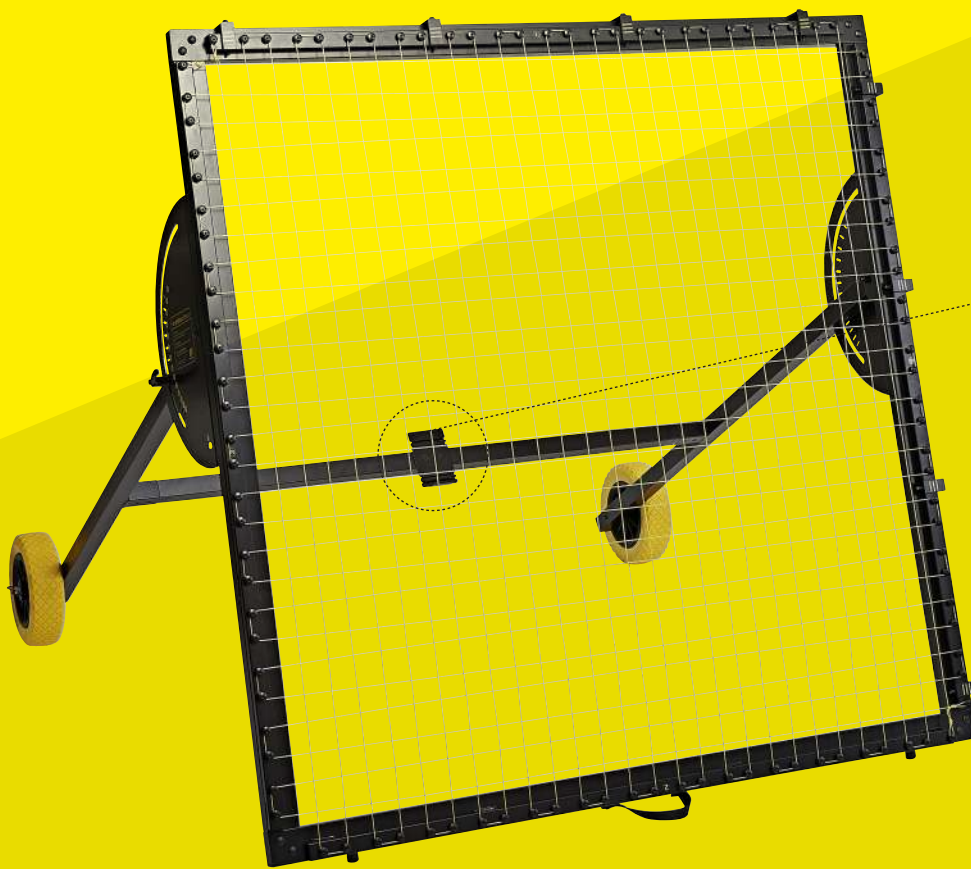

USE	USE
 2x T19	 1x T11

## Free MuninPlay app

With the MuninPlay app you can easily track and share your results. **Download** the MuninPlay app in App Store or Google Play.



# GET STARTED WITH MUNINPLAY



**1. DOWNLOAD THE APP**  
the MuninPlay app is free and works with Android and iOS

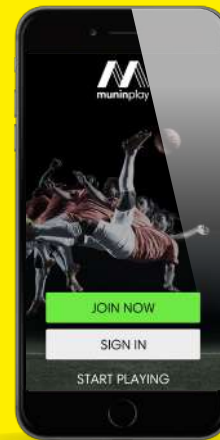

**2. CREATE PROFILE OR START PLAYING**  
Place your phone in the cradle behind the net on your m-station

## 108 SOCCER DRILLS



You can develop your skills much faster if you can measure how capable you are. If you know how quick you are on your feet, if you know how accurately you shoot, if you know how well you control the ball. MuninPlay makes it possible and gives you a unique insight into your skills.

There are 108 drills in MuninPlay, covering everything necessary to turn you into a complete soccer player. From passes, dribbles and first touches to finishing and speed. Each drill is illustrated with easily accessed practice cards and introductory videos. Watch in detail how to do each of the soccer training drills and see how to position m-station, cones and the goal to get the best result.

# PROFILE & STATS



With MuninPlay you get your own soccer profile. It will tell you how much you have practiced, what drills you have completed

and where your strengths are. It will provide you with lots of fun and inspirational data on your individual soccer skills.

# VIDEOS

Watch in details how to do each of the football training drills and see how to position m-station, cones and the goal to get the best result.



# SOCIAL

Find your friends in MuninPlay and check out their latest activities in the friends feed. Select the multiplayer option to compete with your friends and family at home or challenge them online.

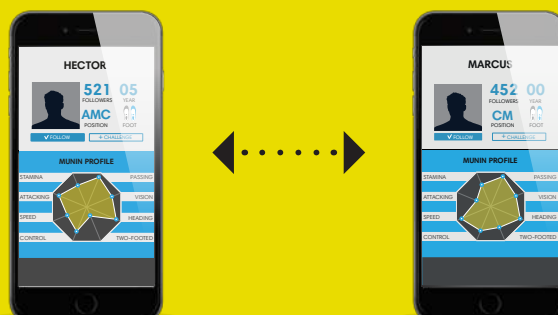

# HOW MUNINPLAY WORKS

---

## 1. CHOOSE DRILL

Open MuninPlay on your phone and select the drill you want

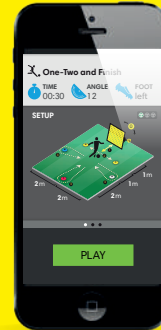

## 2. MOUNT THE PHONE

Place your phone in the cradle behind the net on your m-station

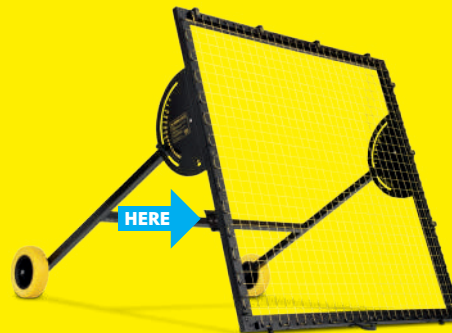

## 3. START PLAYING

Let the fun begin and play alone or with friends



## 4. VIEW STATS

View the stats on your performance and progression



# MUNINPLAY FEATURES

---



## PROFILE & STATS

Get your very own complete player profile. MuninPlay will tell you everything about your skills and your speed.



## VIDEO

Watch in detail how to make each drill and see how to position m-station, cones and goal to get the best result.



## TRAINING DRILLS

More than 100 drills covering everything necessary to turn you into a complete soccer player.



## REAL TIME AUDIO

Your personal coach shouts encouragements and thousands of spectators cheer you on as you perform.



## CHALLENGES

Challenge your friends directly from the app - even if you are standing in separate yards.



## NEWS FEED

Receive updates about your friends and see how much they have practiced, their high scores and much more.



## MULTIPLAYER

Play with your friends and family in your garden. MuninPlay crowns a winner after each game.



## RESULTS & RANKING

MuninPlay keeps track of your best results in each drill so you can compare your progress with your friends.



## HOW TO SELECT TYPE OF PASSES

Untighten the handles in each side, choose the angle and tighten the handles firmly when the new angle is decided.

**Select 0:** Receive passes along the ground!

**Select 1-12:** Receive passes in the air. The higher the number the higher the passes!

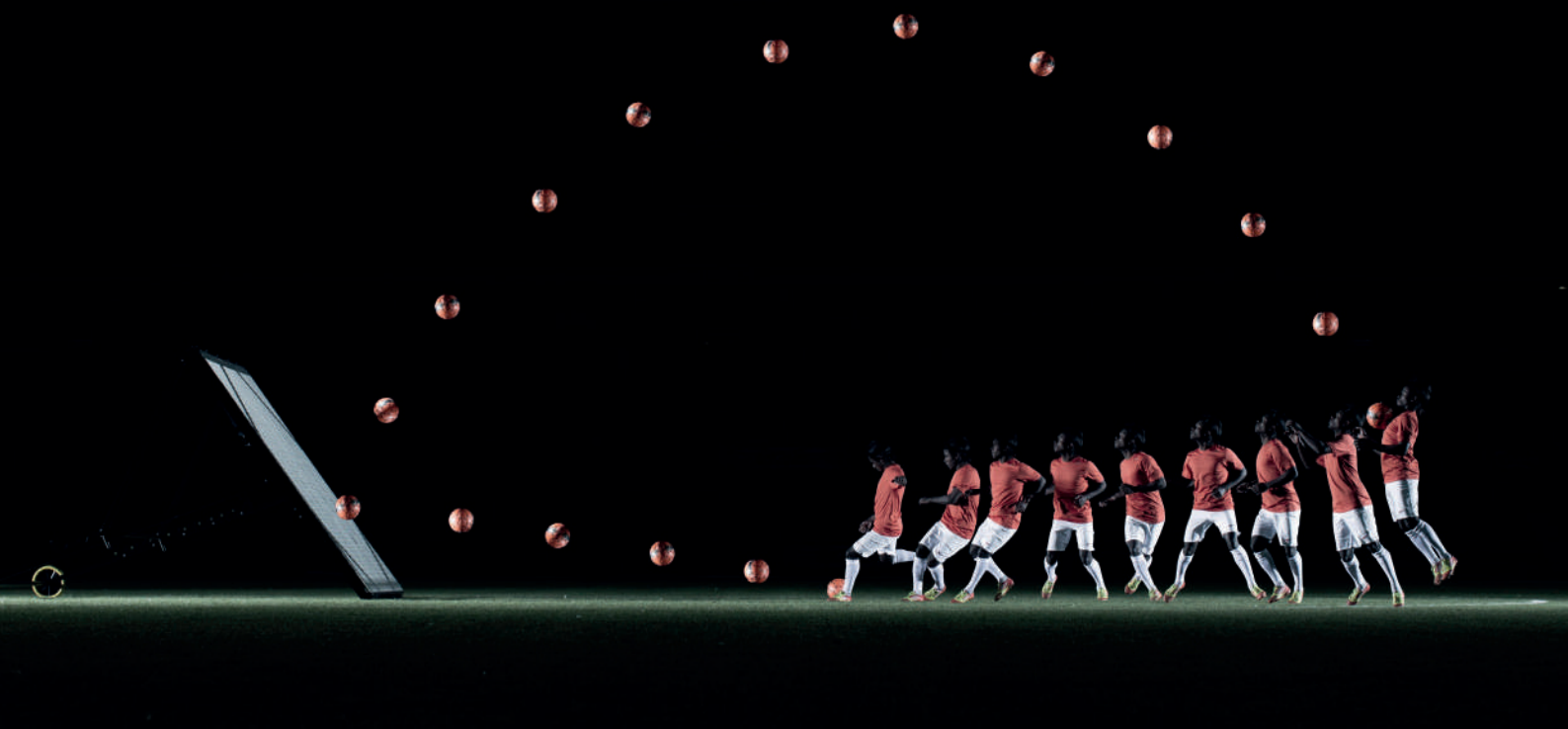

Munin Sports is not responsible for injury or damage to persons or property resulting from incorrect assembly of m-station. m-station is a training apparatus developed for professional football training. m-station must therefore never be used by children under the age of 12. Particular attention is drawn to the fact that small children, if m-station is not used in accordance with instructions, risk becoming trapped in the assembled netting. m-station must not be assembled, dismantled, moved or otherwise handled by a children. m-station must only be used for the exercises explicitly presented on [www.muninsports.com](http://www.muninsports.com). When adjusting the angle of m-station make sure to keep all bodyparts away from any moving parts of the product. Munin Sports disclaims all responsibility for injury and damage to persons or property caused during storage, exercises or other use being undertaken deviating from or in contradiction to the use presented on [www.muninsports.com](http://www.muninsports.com). Storage or use of m-station deviating from or in contradiction of instructions for use takes place at the user's own risk. Never make any changes to the product or use any sparepart not provided by Munin Sports. Review and tighten all screws and bolts every 2nd month.

