



VHF Digital Transmitter

TAVD-5000H

OPERATION MANUAL

Contents

| | |
|--|-----------|
| 1.INTRODUCTION | 1 |
| 2.GENERAL SAFEGUARDS | 2 |
| 2.1. SAFETY AND FIRST AID | 2 |
| 2.2. OPERATING SAFEGUARDS | 3 |
| 3.TERMS OF SALE | 4 |
| 4.WARRANTY | 7 |
| 5.PRINCIPLE OF OPERATION | 8 |
| 6.INSTALLATION | 9 |
| 6.1. UNPACKING AND INSPECTION | 9 |
| 6.2. PANEL CONNECTIONS | 10 |
| 6.3. INITIAL HOOK UP | 10 |
| 7.OPERATING PROCEDURE | 12 |
| 8.CONTROL INTERFACE | 15 |
| 8.1. TOUCH SCREEN CONTROL | 15 |
| 8.2. MAIN SCREEN | 15 |
| 8.3. MENU SCREEN | 17 |
| 8.3.1. RF LEVELS SCREEN | 18 |
| 8.3.2. POWER SUPPLIES SCREEN | 19 |
| 8.3.3. REMOTE INTERFACING SCREEN | 19 |
| 8.3.4. HISTORY SCREEN..... | 20 |
| 8.3.5. DATE AND TIME SCREEN..... | 21 |
| 8.3.6. VERSION SCREEN..... | 22 |
| 8.3.7. CONTACT SCREEN..... | 22 |
| 8.3.8. SETTINGS SCREEN | 23 |
| 9.WEB INTERFACE | 24 |
| 9.1. REMOTE CONTROL (VIA DB25) | 34 |
| 9.2. COMBINER CONTROL | 35 |
| 9.3. BACK PANEL MONITORING | 36 |
| 10.MONITOR AND CONTROL SYSTEM | 37 |
| 10.1. CONTROL SYSTEM OVERVIEW..... | 37 |
| 10.1.1. SYSTEM BLOCK DIAGRAM – 1 AMPLIFIER | 38 |
| 10.1.2. ADRENALINE BLOCK DIAGRAM | 39 |
| 10.2. RF MODULE | 40 |
| 10.3. DISPLAY INTERFACE MODULE..... | 40 |
| 10.4. TEMPERATURE SENSOR MODULE..... | 41 |
| 10.5. DC DISTRIBUTION MODULE | 41 |
| 11.HARDWARE COMPONENTS | 42 |
| 11.1. RF AMPLIFIER PALLET | 42 |
| 11.2. COUPLER | 42 |
| 11.3. RF COMBINER..... | 43 |
| 11.4. BANDPASS FILTER | 43 |
| 11.5. POWER SUPPLY | 43 |
| 12.FACILITY RECOMMENDATIONS | 46 |

| | | |
|------------|---|-----------|
| 12.1. | BUILDING RECOMMENDATIONS | 46 |
| 12.2. | ELECTRICAL SERVICE RECOMMENDATIONS..... | 46 |
| 12.3. | ANTENNA AND TOWER RECOMMENDATIONS..... | 46 |
| 12.4. | SHELTER SECURITY | 47 |
| 12.5. | HEATING AND COOLING REQUIREMENTS..... | 48 |
| 13. | MAINTENANCE | 49 |
| 14. | TROUBLESHOOTING | 50 |
| 15. | SPECIFICATIONS..... | 54 |

No part of this manual may be re-produced in any form without prior written permission from Technalogix Ltd. The information and specifications contained in this document is subject to change at any time without notice.

1. Introduction

Please take a few minutes to read the manual and familiarize yourself with your new Technalogix power amplifier.

This user manual, the Final Inspection Report, and of course our equipment, should be everything you need to get on the air with a superb broadcast signal. We understand that a capable and confident user will get the most out of our product and we have made every attempt to educate readers of all technical levels. If there is something that is not clear, or you require further information, please do not hesitate to contact us and we'll be glad to help out.

Technalogix Ltd.
8156 Edgar Industrial Close
Red Deer, Alberta, Canada
T4P 3R4

Phone: 403.347.5400
Fax: 403.347.7444
URL: www.technalogix.ca
Email: technical@technalogix.ca
sales@technalogix.ca

All information that is specific to your unit is contained within the Final Inspection Report included in the shipped equipment container. This report summarizes performance specifications and this manual provides wiring hookup details and outlines specific components found in the system.

We truly appreciate that you have chosen us as your RF equipment supplier. Happy transmission!

2. General Safeguards

This section is written as a general guide for safe operation of the equipment and is intended for those having previous knowledge and experience with these kinds of equipment. It is not intended to contain a complete statement of all safety precautions, which should be observed by personnel using this or other electronic equipment.

Documentation

Read, retain and follow these instructions before operating the equipment.

Environment

To reduce the risk of fire or electric shock, do not expose this equipment to rain or moisture. Refer all servicing to qualified service personnel.

Servicing

Do not attempt to service this equipment yourself as opening or removing covers can result in personal injury and will void the warranty. Refer all servicing to qualified service personnel.

2.1. Safety and First Aid

Personnel engaged in the installation, operation, maintenance, or servicing of this equipment are exposed to the hazard of high voltage. It is imperative that all safety regulations and precautions are consistently observed. Knowledge of first aid procedures is recommended. The following information is presented as a reference only. The user should ensure that they are properly trained in first aid and the necessary precautions, which may not be contained in this manual, are followed.

- At all times, avoid placing any part of the body in series between ground and circuit points, whether power is on or off.
- Dangerous voltage may be present in equipment even though power is off. Do not open the cabinet. Refer servicing to qualified service personnel.
- It is the duty of all personnel to be prepared to give adequate emergency first aid treatment and thereby prevent avoidable loss of life.
- Respiratory paralysis can cause death by suffocation within seconds. It is imperative that the approved methods of artificial respiration are initiated immediately until medical help arrives.
- A muscular spasm of unconsciousness may render the victim unable to break free of the electric power. If this is the case, turn the power off immediately. Do not touch the victim or you may share the same predicament!
- If the power cannot be turned off immediately, very carefully loop a dry rope, article of clothing, length of strong cloth or a rolled-up newspaper around the victim and pull the victim free of the power source. Carefully avoid touching the victim or clothing. Call for medical help immediately.

2.2. Operating Safeguards

Load Impedance

Technalogix transmitter equipment functions with a 50-ohm load impedance. It is imperative you maintain 50-ohm impedances throughout your system for your equipment to provide maximum power transfer to the antenna and decreased reflected power heading back towards the amplifier pallets. Failure to provide a 50-ohm path throughout the system may result in damage to your equipment. Before anything is turned on, ensure that there is a 50-ohm path from the output of each stage to the input of the next, all the way to the antenna.

Power Supply Voltages

In addition to maintaining proper 50-ohm impedances throughout the signal chain, it is also important, whenever possible, to make sure the RF drive going to the input of the power amplifier is removed before turning on or turning off the DC power supply. This is because the majority of the RF transistors used in the individual amplifier pallets are fabricated with LDMOS (Laterally Diffused Metal Oxide Semiconductor) technology. Typically, they do not like to make any RF power when their supply voltages are not within a specific range. When you first turn your power amplifier on or off, the DC power supply's output voltage may take a while to stable out to a safe operating voltage. Wait ten (10) seconds before applying the RF drive to ensure no issues arise.

Operating Warnings

Our transmitter equipment is designed to reliably generate a specific RF output power level. Failing to adhere to overdriven amplifier, high reflected power, and high temperature, and other warnings can decrease the reliability of your system and may result in damage to the unit. If you need to transmit to a little larger coverage, you are better off increasing antenna gain, and more importantly, antenna height above average terrain. On TV broadcast frequencies, insufficient antenna height puts an upper limit on your range, regardless of power levels, as the distance from your antenna to the radio horizon is limited.

The radiated power from the cabinet of this device is below the Industry Canada radio frequency exposure limits. The device should be used in such a manner that the potential for human contact with the antenna during normal operation is minimized.

3. Terms of Sale

Sales by Technalogix Ltd. ("Seller") are made only on terms which are contained in this policy. Seller hereby gives notice of its objection to any different/additional terms and conditions. All sales are expressly conditional upon Buyers' assent to the terms and conditions set forth below. These terms and conditions may be modified/ supplemented only by written document signed by authorized representative of the Seller. These terms and conditions supersede any prior and/or contemporaneous agreements/correspondence between Buyer and Seller. Any order received and accepted by Seller shall be construed as acceptance of Seller's offer to sell its products to the Buyer in accordance with terms and conditions of sale set forth herein. No waiver, whether express or implied, by Seller of any of the terms or conditions hereof shall be deemed a continuing waiver or trade custom between parties, but shall apply solely to the instance to which the waiver is directed.

Ordering Information

All orders must be in writing and/or accompanied by a Purchase Order. A minimum down payment is required with all orders. No orders are considered an order until the payment has been made.

Pricing Policy

All prices are FOB shipping point and prices do not include freight, handling, and insurance. All prices published/quoted by Seller may be changed at any time without notice. Unless otherwise specified, written quotations expire 30 days from date issued and subject to change/termination by notice during this period.

Taxes

Prices for all products do not include any sales, use, excise or other taxes. Buyer agrees to pay all applicable taxes, duties and other fees on product and services ordered. If Buyer claims an exemption from any tax, Buyer shall submit to Seller the appropriate exemption certificates.

Shipping

Shipping is the responsibility of the Buyer. This includes all freight, customs and brokerage charges, duties, and insurance.

Terms of Payment

Seller will provide credit terms to Buyer at its discretion. Such terms are subject to change at all times. If credit is provided, Seller will invoice Buyer on the date the product is ordered. Such invoices will be due and payable net thirty (30) days from the date of invoice, subject to credit is not established or maintained, terms shall be net cash on or prior to the Delivery Date. Seller reserves the right, at its sole discretion at any time to revoke any credit previously extended. Past due accounts shall be charged two percent (2%) per month, or the highest rate permitted by Alberta law, whichever is less, and will be added to the outstanding balance. In the event Buyer defaults on the payment, Buyer shall be liable for all collection costs, including reasonable attorney's fees and costs. Non-payment of past due accounts will result in a lien against parts and all subsequent assemblies or products that our components are in. Goods remain the property of Seller until invoice is paid in full.

Changes and Cancellation

Purchase orders that have been accepted by Seller may not be changed/ cancelled, in whole or part, without written Seller consent. All changes must be included in a change order reflecting purchase order and submitted to the Seller. All other changes will not be accepted/acknowledged. Changes may affect delivery dates. Expenses incurred because of changes shall be charged to Buyer. Buyer will be liable for Seller's costs incurred, plus a reasonable profit, for the portion of work terminated, in accordance with generally accepted accounting principles, together with cancellation charges. Orders for standard product may be changed by Buyer, with no penalty to Buyer, provided that Buyer provides Seller notification at least 30 days prior to scheduled ship date. Order changes received within 30 days of scheduled ship date may be subject to an order change charge; a schedule detailing these charges will be forwarded to Buyer when Buyer's change order is acknowledged. In no event can any aspect of the order be changed after the product shipment has occurred. Custom orders may be cancelled by Buyer, provided that Buyer pays Seller for completed work allocated to Buyer's order at time of termination of the work at selling price and all costs for work-in-progress and costs resulting from cancellation and reasonable profit therein. Specific cancellation charges dependent on the type of custom product ordered. A schedule detailing these charges will be forwarded to Buyer when Buyer's cancellation fee of up to 100% of the order, depending on the stage of completion of the order at the date the cancellation or revision is accepted.

Custom Products Policy

Custom items are not returnable. Items other than "off the shelf" products are considered custom and are products/materials which have been altered, amended and customized to your order, and not resalable.

Returns

Product return without written authorization by Seller will not be accepted. Returns accepted only with a valid Return Material Authorization (RMA). To receive authorization for product return, call Seller. There is a standard 25% restocking cost assessed on most returns. All returned products (non-repair) must be unused, and in original condition. No refund/credit given for damaged products. We do not accept postage-due/ C.O.D. packages at any time.

Excusable Delay

Seller shall not be liable for any loss or damage resulting from any delay in delivery or failure to deliver which is due to any cause beyond Seller's control, including, without limitation, acts of nature, unavailability of supplies or sources of energy, riots, wars, fires, floods, epidemics, lockouts, strikes and slowdowns, delays in delivery by supplies, or acts or omissions of the Buyer. The Buyer shall be liable for stage charges, including but not limited to all third party costs and expenses incurred by Seller, in holding or storing products for the Buyer or at the Buyer's request.

Assignment

Buyer shall not assign any duties nor assign any order or any interest therein without written consent of the Seller. Any such actual or attempted assignment shall entitle Seller to cancel the order upon written notice to the Buyer.

Installation

Seller assumes no obligation to install any product sold to place any products in working order at Buyer's premises and not responsible for freight damage.

Validity of Separate Clauses

If any provisions of this agreement shall be held invalid, illegal, or unenforceable, the validity, legality or enforceability of the remaining provisions shall not be affected or impaired thereby.

4. Warranty

Technalogix products have been completely tested and found to meet specifications and be in proper operating condition. Technalogix-manufactured products are warranted to be free from defects in materials and workmanship for a period of two (2) years from the date of shipment. Products sold through, but not directly manufactured by Technalogix, carry the original manufacturer's warranty. Seller will not be liable for damages of whatever nature arising out of or in connection with the equipment or its use thereof. Technalogix does not assume responsibility for injury or damage resulting from the practices of untrained or unqualified personnel in the handling of this equipment and does not include misuse, neglect or accident, incorrect wiring and/or improper installation, unauthorized repairs, modifications or use in violation of instructions issued by Seller, incidental or consequential damages as a result of any defect, reshipment cost or insurance of the unit or replacement units or parts, acts of nature, damages due to AC or DC power supplied by customer to power the equipment (see installation recommendation for surge protection), or acts of terrorism. Seller agrees, at our option, to remedy warranted defects or furnish a new part in exchange for any part of unit which, under normal installation, use and service, becomes defective. The user pays for transportation costs to and from repair facility. If you require on-site service, please contact our sales department for pricing and conditions.

5. Principle of Operation

The RF power amplifier is designed to take a modulated RF carrier at a low level (typically less than 10 dBm, but custom levels available), and amplifies the carrier to a level that is suitable for transmission through an antenna, or alternative load. The power amplifier feeds this load through an inline wattmeter and transmission line. For broadcast and over-the-air amplifier systems, the pattern of the antenna then dictates the range and coverage area.

The amplification is accomplished by one or many amplifier pallets internal to the power amplifier system. If there is more than one amplifier pallet stage, then the first pallet acts as a driver feeding Intermediate Power Amplifiers (IPAs) and/or final stage pallets. If multiple final pallets are required, then a splitter and combiner are also required before and after the final stages.

We manufacture amplifiers and transmission systems for a wide range of frequencies. Due to the fact that some of the internal components are frequency specific, not all RF amplifier systems are agile across all frequencies. For example, typically pallets for the North American broadcast markets are broken down into operation over VHF Band I (channel 2-6), VHF Band III (channels 7-13), and UHF (channels 14-69). Custom frequencies are available upon request, but please note that frequency selection must be made at time of order, as most RF amplifier systems are calibrated and tested to the frequency requested and are typically not field tuneable.

The RF amplifiers utilize readily available RF components wherever possible, thus enhancing the serviceability of the equipment. The amplifier modules are stable for high reliability and long service life and feature ultra linear amplification and individual channel RF output filtering, unless ordered otherwise.

The Block Diagram is included in this manual to illustrate the specific component flow of the RF amplifier system and to provide specific configuration and model information.

6. Installation

This section contains unpacking, inspection, and installation instructions for the power amplifier or transmitter. Please read the following sections carefully prior to setting up the equipment.

6.1. Unpacking and Inspection

Check the outside of the container. Carefully open the container and remove the power amplifier or transmitter and any accessories. Retain all packing material in the event that the equipment must be returned to the factory.



Exercise care in handling equipment during inspection to prevent damage to the equipment. Some pieces of the equipment may be heavy.

Visually inspect the enclosure of the power amplifier or transmitter for damage that may have occurred during shipment. Check for evidence of water damage, bent or warped chassis, loose screws or nuts, or extraneous packing material in connectors or fan failures. Inspect all connectors for bent connector pins. If the equipment is damaged, a claim should be filed against the freight carrier once the extent of the damage is assessed. Technalogix cannot stress too strongly the importance of immediate careful inspection of the equipment and subsequent immediate filing of the necessary claims against the carrier if necessary. If possible, inspect the equipment in the presence of the delivery person. If the equipment is damaged, the carrier is your first area of recourse. If the equipment is damaged and must be returned to the factory, phone for a return authorization number. Claims for loss or damage may not be withheld from any payment to Technalogix, nor may any payment due be withheld pending the outcome thereof. Technalogix cannot guarantee the carrier's performance.

6.2. Panel Connections

| | |
|----------------|---|
| AC IN: | Single phase AC input to feed internal AC/DC switching power supplies. Check with factory as not all power supplies are universal 110/220V. |
| RF OUT: | Modulated RF carrier output (N female or 7-16 DIN female standard) |
| REMOTE PORT: | Parallel parameter interface (DB25 female) |
| ETHERNET/SNMP: | Ethernet or Simple Network Management Protocol (SNMP) connection for remote control and monitoring (RJ45 jack) |
| CAN: | Control Area Network (CAN) expansion bus (RJ45) |
| RF IN: | Modulated RF carrier output (BNC female or SMA female standard) |

6.3. Initial Hook Up

1. If applicable, ensure that the antenna or alternative load has been swept and, ideally, has a return loss of greater than 20dB (VSWR = 1.2:1). This should be done before connecting the antenna/load cable to the system's output. The power amplifier's control system allows the user to change the VSWR trip point up to a maximum level of 1.8:1, unless a custom VSWR protection system has been requested. Strive for the lowest possible return loss to maximize transmission distance and improve operating performance. Unless requested otherwise at the time of purchase, VSWR levels between the trip point set by the user and 1.8:1 (or custom VSWR trip point) will cause a fold back in power. VSWR levels past 1.8:1 (or custom VSWR trip point) will cause the system to shut down or fold back with attenuation to avoid damage.
2. Place the amplifier in its permanent location near a receptacle supplying the required AC or DC mains voltage.
3. Place an appropriate AC or DC power line protector, conditioner, and/or surge suppressor across the supply line. This small investment is highly recommended to protect the equipment from power surges and spikes (not covered by warranty).
4. Install a lightning surge arrestor or Gas Discharge Tube (GDT) on the coax near the antenna or alternative load to protect the amplifier. This small investment is highly recommended to protect the equipment from lightning (not covered by warranty).
5. Connect the transmitting antenna, or alternative load's cable to the RF OUT female connector on the PA enclosure's RF output. On units that have a separate filter or filter/power supply enclosure after the power amplifier enclosure, connect the transmitting antenna, or alternative load cable on the last enclosure in the chain to the RF Out and connect the RF coaxial between the power amplifier and the second enclosure in the chain. The system must be loaded into a 50-ohm load before any power is turned on for over-the-air systems.

6. Check that your baseband source is present, whether it is from an RF generator, encoder, mux, or otherwise, to feed the modulator if the system is a transmitter, for broadcast applications. If the system is a translator, ensure that the modulated RF signal is present at the input to the processor/translator that will feed the power amplifier. In the case of alternative modulation schemes, ensure that the source feeding the front end of the power amplifier is present and stable.

Note that some of our (and other manufacturers') products contain input signal detection and will turn off the carrier in the event of a missing input signal. Checking for a valid input signal can potentially save a lot of time.

7. Hook up the modulator, processor, or source as shown in their respective manuals. Power level adjustment should be made through the power amplifier. If the front end modulator, processor, or source was not provided by Technalogix, ensure that its RF output level is turned down as far as possible. This will help ensure that the different product does not initially overdrive the power amplifier due to mismatched RF levels. You will have to adjust the RF level to achieve the specified output power on the amplifier. For front end equipment supplied by Technalogix, we have already factory set the source RF output level to properly drive the power amplifier. Please check the specifications sheet supplied with your amplifier to know what input level to the amplifier(s) is required to meet output power.



Do not connect the modulated signal from the RF OUT on the modulator, processor, or source to RF IN on the power amplifier at this time. Because of the characteristics of LDMOS devices, the RF drive should not be connected to the power amplifier until after the power supply and bias voltages are present and stable.

8. If the power amplifier system includes a power supply that is external to the power amplifier enclosure, install the DC power supply leads between the power supply enclosure and power amplifier enclosure. If the power supply is internal to the amplifier, then all DC wiring is already hooked up.

At this stage, the system is set up and ready to do a preliminary start up, as outlined in the "Operating Procedure" section.

7. Operating Procedure

Assuming the previous installation instructions have been completed and cautions noted, and the power amplifier is ready to receive a properly modulated RF signal, proceed with the following steps to place the system in operation. The power amplifier has been factory aligned for a specific frequency (per system specification), signal levels and optimum performance.



IT IS HIGHLY RECOMMENDED THAT YOU RUN YOUR SYSTEM INTO A DUMMY LOAD BEFORE INSTALLING TO MAKE SURE THERE IS NO DAMAGE SUSTAINED IN SHIPPING AND THE UNIT IS RUNNING PROPERLY

1. Verify that all control and RF cables are tight and properly seated in or on the mating connector.
2. Plug the modulator, processor, or RF source into AC mains (specified by the modulator/processor manufacturer), while the RF input to the power amplifier is still disconnected.
3. With the power amplifier loaded into the filter (if installed), and the filter loaded into the antenna, alternative load, or dummy load if there is an external filter in the system, power up the amplifier by turning on power supply either via the ON/OFF switch on the back of the power amplifier, or if the system has an external power supply, via the ON/OFF switch on the back of the power supply enclosure. In the case of three-phase mains, the power switch will be located on the power distribution enclosure and likely activates a contactor to supply AC to all of the systems' power supplies.
4. Verify that the power amplifier fans are all on. The power amplifier fans are powered via DC voltage so this is an indication that the power supply is started and running. There may be fans installed in the filter or power supply enclosures, if applicable.
5. If enabled, the internal soft start circuitry will turn the bias voltages off until the power supply to the amplifier pallets is fully stable. The front display indicates when the soft start is running via maximum attenuation on the touch screen display. Once complete, the Forward and Reflected Power, Power Supply, and Temperature readings will appear on the display.
6. Some units may display a low input level warning and attenuation may be added. This ensures that the power amplifier has placed maximum attenuation on its input and is ready to receive the RF drive signal. On systems with the touchscreen option installed, this attenuation is displayed in the lower right corner of the screen (39 dB is maximum attenuation).
7. With the RF drive signal still removed, view the idle (quiescent) currents. Compare these currents for the amplifier pallets against those listed in the Final Inspection Report and ensure they match within 10%. If the unit contains more than one final amplifier pallet (illustrated in the Block Diagram), ensure that the final pallet currents on the multiple finals all match within 10% of each other. With multiple finals, the final pallet currents should always match within this range under all operating conditions.

8. After the warm up and soft start (if enabled) is complete, apply the RF drive signal (and adjust the level for non Technalogix supplied front end equipment) between the modulator, processor, or RF source and the power amplifier RF In (BNC female, 50 ohm). This ensures that the RF drive signal is applied only after the power supply is stable and the bias voltages are applied to the amplifier. Remember that some front end equipment has input signal detection, and if the input is not present, then they may turn off the RF carrier at the output of the modulator or front end equipment.
9. Adjust RF output power on the power amplifier to about 10% of rated forward power. The output power level is adjusted from the power amplifier's RF Levels screen. If the unit contains more than one final amplifier pallet (illustrated in 10.1.1 Overall Control Block Diagram) ensure that the final pallet currents on the multiple finals all match within 10% of each other. With multiple finals, the final pallet currents should always match within this range under all operating conditions.



Front panel readings will vary slightly upon turn on. Steady state parameters can be taken after approximately one hour.

10. Ideally, the RFL Power should read zero. However, should a high VSWR be detected, the system will automatically fold back, shut down and cycle, or do nothing more than indicate VSWR level, as described in the control system section (optional VSWR configurations available). Under normal conditions, a well installed and setup system should indicate RFL power less than 3% of FWD power.
11. Adjust RF output power on the power amplifier to desired level. Verify that the FWD Power reads 80 to 100% of the system's rated power on the PA enclosure - depending on the modulation of the signal content. The system is set up for 100% of the modulation that was ordered, for example, 100% peak sync NTSC power, 100% rms 8VSB, or 100% CW unless otherwise specified. The output power level can be adjusted from the power amplifier's RF Levels screen. Keep in mind that the system will fold back or shut down (depending on severity) should the forward RF output power level exceed the trip overdrive point.



Please note that 100% should be the maximum FWD power. Typically, customers run the systems at 90% to avoid occasional AC power line spikes or transients from tripping the shutdowns. The difference of 10% will provide a marginal difference in range (tower height will have a much more significant effect on range in the case of over-the-air).

12. Verify that the power supply reads correctly (see supplied final inspection sheet for factory settings of power supply levels) on the display of the power amplifier. You should see no more than 3% fluctuations in DC supply voltage, and even less with a properly conditioned AC source to the power supply.
13. Look at the transmitted output using suitable test equipment. If the modulation scheme is for video, the picture and sound quality should be clean and sharp. If the output picture and sound quality is unsatisfactory, check the input signals, connections to the antenna system, antenna and transmission line VSWR, and the physical condition of the antenna.

14. After warm up, compare the temperature of the equipment from the front display to the temperature recorded in the final inspection sheet, included in shipping. Assuming ambient temperatures are close (our factory is typically around 18 to 25°C), your temperature reading should be very close to the factory reading. Use your temperature measurement as a method to monitor fan performance (though on higher power units, fan current is also monitored). A fan failure or air blockage will show an increase in temperature, assuming ambient temperature is not varying.

For broadcast applications, if the quality of transmission is unsatisfactory, the difficulty is often with the receiving antenna or with obstructions in the path between the amplifier/antenna and receiver. There is also a troubleshooting section located later in this manual.

At this time, Technalogix recommends that you document your measurements to use as a reference over time. The measurements can be made either from the front display, or remotely via the Remote Port (DB25), Ethernet (lower RJ45), or SNMP (lower RJ45), whose operation is explained in section 10. Monitor and Control System.

8. Control Interface

8.1. Touch Screen Control

All switch/settings and user interface is handled through the resistive touchscreen on the front panel. The interface provides the user with the ability to monitor the following power amplifier parameters from the front panel:

- Forward (incident) power at the power amplifier output.
- Reflected (reverse) power at the power amplifier output.
- DC voltage of the power amplifier's power supply.
- DC current in the power amplifier.
- Temperature of the heat sink of the power amplifier.
- The time since the amplifier was last shut down.
- History of faults and events
- Mode of the power amplifier (selectable between Manual and AGC).
- Indication if there is attenuation added to the front end of the power amplifier indicating fold back in RF power (indicates amount of attenuation)
- Settings to change the VSWR trip point shutdown between 1.1:1 and 1.8:1.
- Settings to change the RF power units between % power (maximum of 110%) or watts.
- Summary of PCB modules and assembly numbers specific to the power amplifier

This manual outlines the standard factory control system. Custom firmware requests may cause the control system and amplifier to deviate from the described operation. Please consult factory for any client-ordered custom settings.

8.2. Main Screen

From the main screen, as seen in the figure below, all of the system's main parameters can be viewed at a quick glance. The three (3) main sections of this screen are the four (4) level bars, the summary bar at the bottom of the screen, and the carrier ON/OFF button. The level bars show real time system performance and help illustrate any transient changes that occur. The FORWARD POWER and REFLECTED POWER level bars can also be shown in watts (a full description of how to do this is found in the SETTINGS section). The summary bar at the bottom of the screen will stay in place no matter what screen is being viewed to allow for an operating summary at any time. Also from any screen, the RF amplifier's carrier can be turned on or off to facilitate adjustments, settings, and testing/troubleshooting.

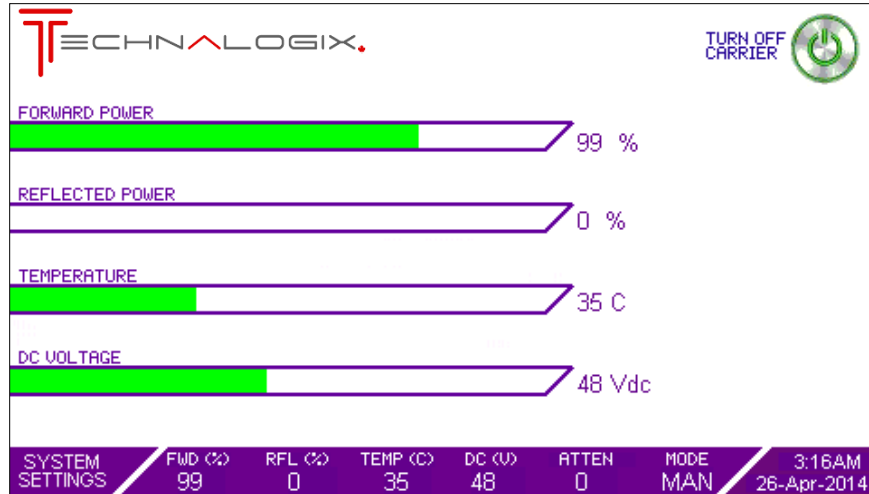

SYSTEM SETTINGS

Toggles between Main Screen and Menu Screen. The menu screen has additional settings and monitoring over the Main Screen, and is illustrated in the next section.

FWD (99)

Forward RF power level in % out of 100 or in watts. Mimics data from level bar. Overdrive protection starts at 110% where the power amplifier folds back power by adding attenuation to the power amplifier input until a safe level obtained. System continually checks power level and tries to bring RF power level back to where it was when the fault occurred. If overdrive occurs, a warning is also displayed in red text near the top of the touchscreen and the event recorder logs the event.

RFL (2)

Reflected RF power level in % out of 100 or in watts. Mimics data from level bar. The high VSWR fault occurs when the measured VSWR of the system exceeds the user-defined VSWR trip point found in the RF Power Menu (described later in section). If the VSWR exceeds the user defined shutdown level, but is below 1.8:1 (or a custom VSWR protection point), then attenuation is added to the power amplifier input until a safe level is reached. If the measured VSWR exceeds 1.8:1 (or a custom VSWR protection point, then the RF carrier is turned off to protect the amplifier chain. At this point, the system will continually check to see if it is safe to come back on. This protection scheme helps ensure that the system stays on the air as long as possible before doing a complete shutdown. If high reflected occurs, a warning is also displayed in red text near the top of the touchscreen and the event recorder logs the event.

TEMP (22)

Temperature from sensor mounted on heat sink surface. Shutdown trip point is factory set at a predetermined level to keep the amplifier pallets safe. Should a fan fail inside the power amplifier enclosure, or air conditioning fails inside the broadcast facility causing the temperature to exceed the trip point, the control system will lower forward RF power until a safe level of measured temperature is achieved. The system will continually try and bring the RF power back to the same level when the fault occurred if it is safe to do so, a warning is displayed in red text near the top of the touchscreen, and the event recorder logs the event.

ATTN (0)

RF output power is determined largely in part by the amount of attenuation that the control system places on the input of the power amplifier. Whether a fault occurs and attenuation gets added or the user requests a change in RF power level via the web/SNMP/Remote Port interface, the attenuation section of the summary bar conveys important operating information. If the user requests a change in forward power level via the web interface, SNMP monitoring and control, or via the Remote Port connector on the back of the enclosure an asterisk (*) is placed next to the attenuation value in the summary bar. This informs the user whether or not the attenuation was added due to a fault or simply because it was requested.

MODE
MAN

Automatic Gain Control (AGC) or Manual mode. In AGC mode, the control system maintains a user-settable forward RF power level by monitoring output power and making slight adjustments as necessary. The system tries to maintain the maximum of the AGC target level. There is no level control beyond error handling protection. The user can toggle back and forth from AGC and Manual modes by going to the RF Levels Screen and changing the mode.

7:42AM
3-Jul-2010

Date and Time. Displays current date and time. Power amplifiers ship from factory with default Mountain Standard Time (MST). Users can adjust this info from the Date and Time Screen. The event recorder pulls this info when it logs an event so the user can correlate events in the field. Events stored prior to a date and/or time change will maintain their original event stamp and will not be modified to reflect the change. A Real Time Clock holds time for about one week without AC power

TURN ON
CARRIER 

Carrier ON/OFF switch. By pressing the power switch on the touchscreen, the user can turn on or off the RF carrier. The same result occurs by turning on or off the system via the web or SNMP interface, or through controlling of the Remote Port. A quick beep from the on-board buzzer signifies that the response has been taken. The power supplies and fan will remain active while the carrier is turned off via this switch

TURN OFF
CARRIER 

8.3. Menu Screen

The menu screen allows the user to dive into further details of the power amplifier's operations. Pressing the BACK TO MAIN button will toggle between the Main Screen and the Menu Screen. The Menu Screen is shown below:



Each of the menu icons on the Menu Screen allow the user to take additional readings or make settings that are not provided from the Main Screen. Any changes to settings will be stored in non-volatile memory with the exception of the date and time which are stored as long as the backup battery remains charged (approximately one week of loss of AC power or power down).

While the user is in the sub menu screens (anything besides the Main Screen), full monitoring and protection is taking place. This means that as a user makes a change to a setting or parameter that jeopardizes the power amplifier, the control system will provide protection, display the fault in red text near the top of the touchscreen, and stay in the current menu.



8.3.1. RF Levels Screen

This screen allows the user to change settings to the RF levels, including the Forward RF level. The reflected (VSWR) trip point is changed from this screen. From the RF Levels screen, the user can also toggle between AGC and Manual mode. The RF Levels Screen is displayed below:

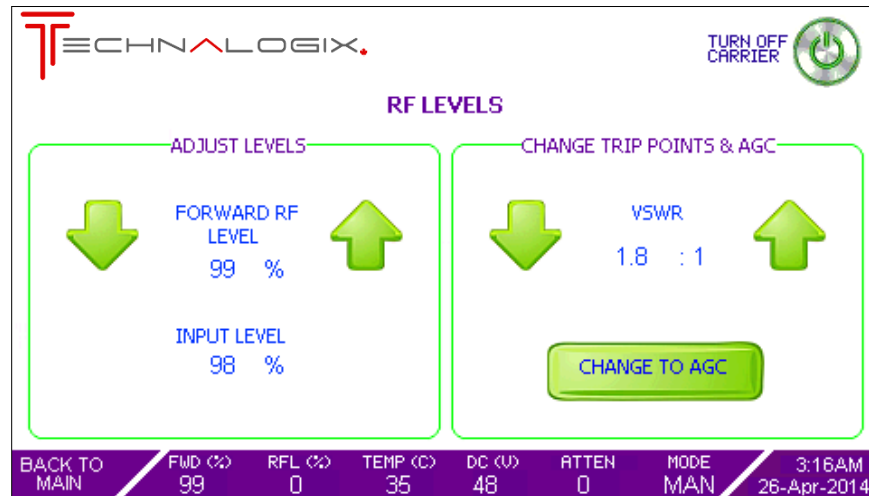

To adjust Forward RF Level (functional only in AGC mode):

Press the up or down arrows (in either 1 or 10% increments or decrements) until the desired Forward RF level is reached. If the adjusted level exceeds 110%, the protection will kick in and the system will fold back the RF power to a safe level. There may be a residual amount of Forward power even at 0% setting, but it should be insignificant.

To change the VSWR Shutdown Trip Point:

Use the up and down arrows to set the VSWR shutdown trip point to between 1.1:1 and the factory determined upper limit. If a measured VSWR is found above the set trip point, but below the factory determined upper limit, then the system will fold back the forward power to a safe level. If the measured VSWR exceeds the factory determined upper limit, then the carrier will be initially turned right off.

To toggle between Manual and AGC Mode:

Press the CHANGE TO MANUAL or CHANGE TO AGC button in the Adjust Levels half of the screen. In AGC mode, the system will default back to Manual mode and protective action will be taken. In the event of a fault while in AGC mode, the system will maintain the AGC mode, but corrective actions will be taken to try to protect the unit.



8.3.2. Power Supplies Screen

This screen allows the user to view individual voltage and current readings. The Power Supplies Screen is displayed below:

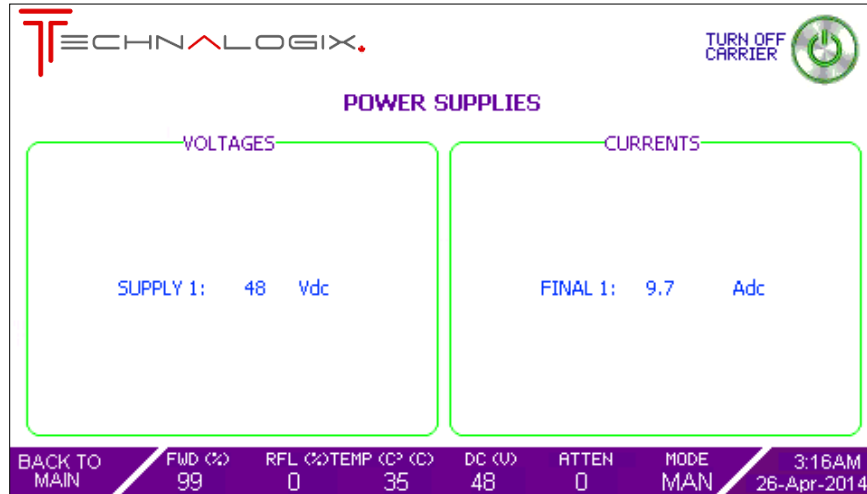

DC supply voltages are nominally 30 or 48Vdc depending on the system. Readings of this voltage in the Power Supplies Screen, and on the summary bar at the bottom of the touchscreen, should not vary more than +/- 2%.

If multiple amplifier pallets are included in the amplifier chain, then the individual currents will all be displayed in the Currents section of the screen. In the case of multiple pallets in the chain, typically the user should see matching of the final pallets to within approximately 10%. Anything outside this range is usually a sign that there may be an issue. Transistor device or circulator / isolator load damage could be the culprit. Our team would be glad to walk you through any troubleshooting issues or questions you may have.



8.3.3. Remote Interfacing Screen

The Remote Interfacing Screen is a summary of what features are installed into the control system, as seen in the following screen shot.

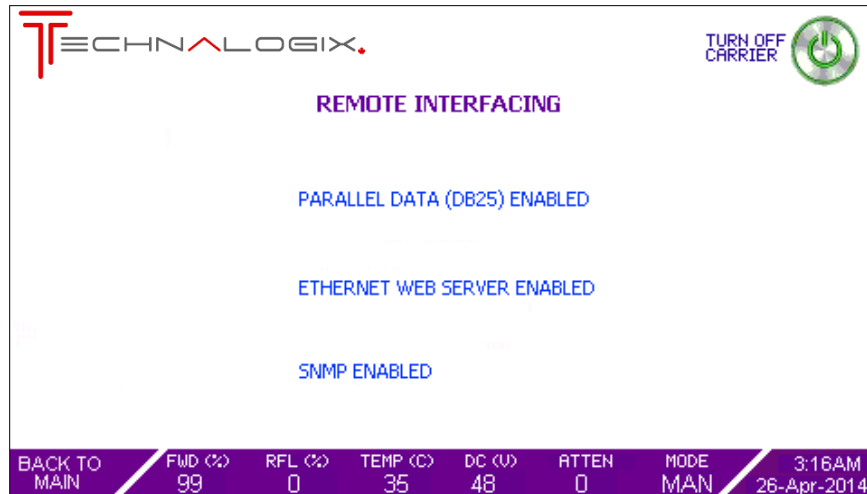

The Remote Port, or parallel data, through the DB25 connector on the back panel of the enclosure extracts the majority of the internal system information and provides it externally for processing and control. The Remote Port is the equivalent of a standalone external remote monitor.

The Ethernet web server provides a means to monitor system information via a web site. This is accomplished via the Ethernet connector on the back panel of the power amplifier. The unit's IP address is listed in the Version Screen.

The SNMP offers a third method of monitoring system parameters and external control. The user's Network Management System (NMS) can monitor multiple broadcast sites remotely and control common functions of the system via the Management Information Base (MIB).

Detailed information on remote interfacing subsystems can be found in Section 9 Web Interface.



8.3.4. History Screen

The History Screen provides a summary of the most recent events that have occurred in the power amplifier, including the date and time of occurrence. An event can either be a fault or an action like turning on or off the carrier. The format of the History Screen is illustrated below:

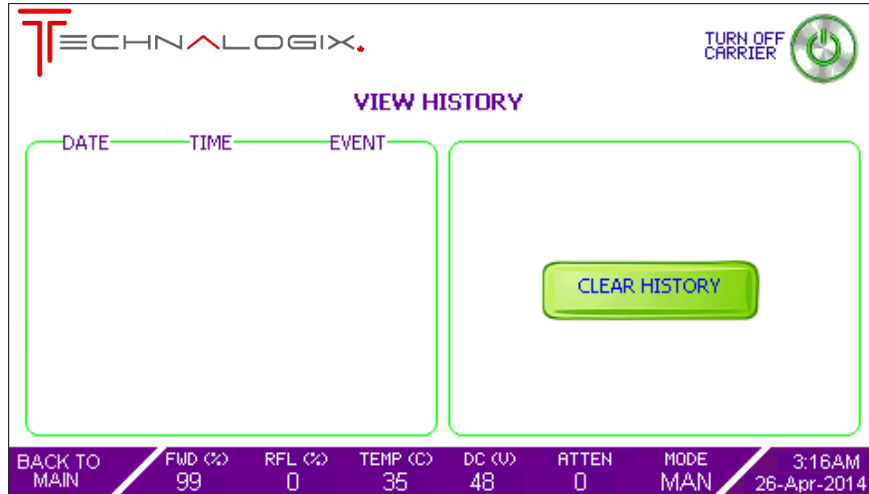

The ten (10) most recent events are displayed on the History Screen. As more events occur, the earliest recorded event gets displaced on the screen. If the user changes the time and/or date from the Date and Time Screen, then the events that occurred before the time and/or date change remain unchanged with their original time stamp.

The user can clear the history screen by pressing the CLEAR HISTORY. Users will find this screen useful in correlating events in the power amplifier with external events like weather and changes to the broadcast facility's environment.

The events are recorded in non-volatile memory so they are safe in the event of a power outage or damage due to lightning.



8.3.5. Date and Time Screen

The Date and Time Screen is used to update the date and time of the control system. This is typically used to create accurate correlations between the event history and events that are external to the system.

The time is factory set to the factory's Mountain Standard Time (MST).

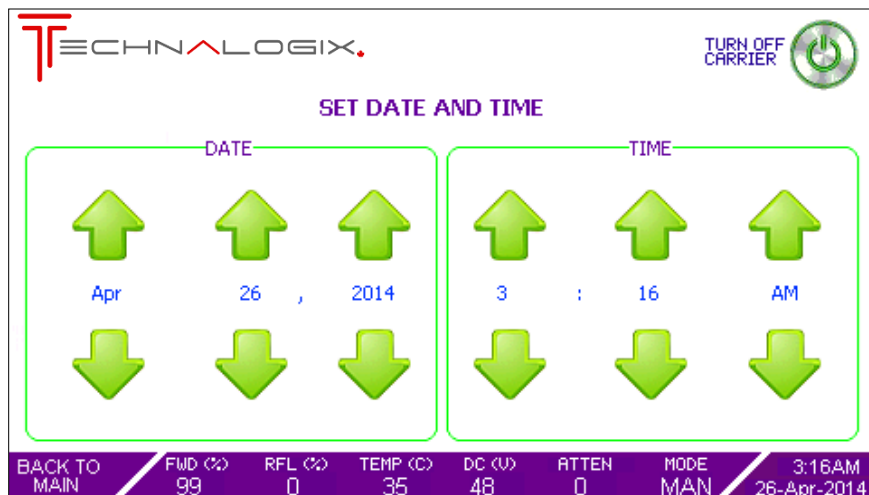

Changes to the date or time are made by pressing the up or down arrows associated with each section (month, day, hour, etc). Any changes will immediately be seen in the summary bar on the bottom right of the touchscreen. When the changes are made press the BACK TO MAIN button to continue to other screens.



8.3.6. Version Screen

The Version Screen contains no user-settable items, but is intended as an identification screen to the user. It also helps us maintain our unmatched service reputation by allowing our technicians and Service team to know exactly what versions of PCBs are inside a customer's unit, even several years down the road. The versions can then be correlated to factory documentation. In addition, current government certification numbers are included for Industry Canada and FCC. Please contact the Seller if you require copies of the actual grants, or visit:

FCC: <https://fjallfoss.fcc.gov/oetcf/eas/reports/GenericSearch.cfm>
(grantee code QH5)

Ind. Canada: <http://www.ic.gc.ca/app/sitt/reletel/srch/nwRdSrch.do?lang=eng>
(company 3803)

Unit identification information is also included in the Version Screen. The Version Screen is illustrated below:

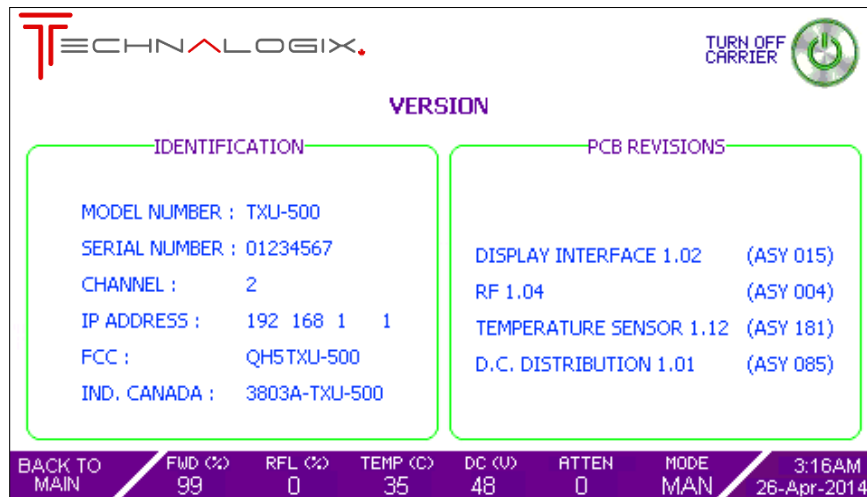

8.3.7. Contact Screen

The Contact Screen provides an easy means for the user to get in touch with us for anything. Whether you have a technical or installation question or simply want to chat, we welcome questions, feedback, and contact.

If you are in the area, please feel free to stop by to tour the facility, test drive some state of the art products, or get a refresher on some training.





8.3.8. Settings Screen

The Settings Screen allows the user to modify some of their preferences on how information is displayed on the touchscreen, as seen in the figure below:

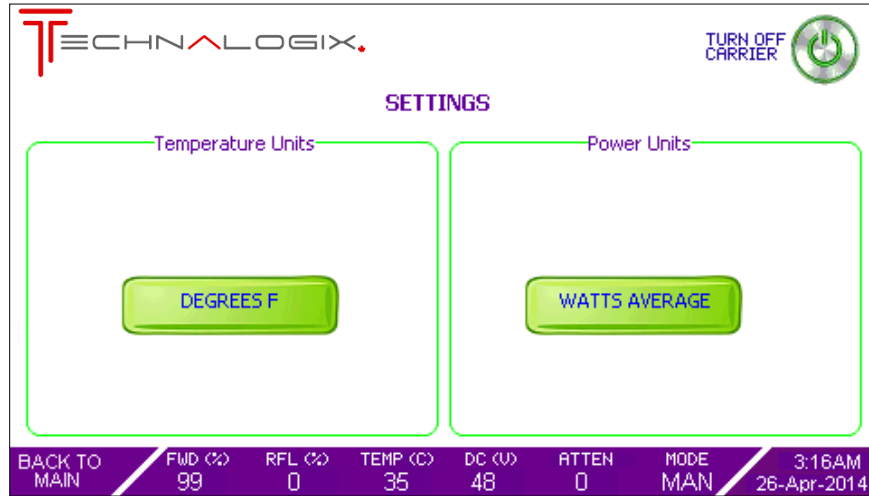

Pressing the DEGREES F button will convert all temperature readings to degrees Fahrenheit from Celsius (and vice versa). Temperature protection trip points are factory set.

Similarly, the user can switch between watts or percentage for their RF power readings. When in percentage mode, the power amplifier is designed for a maximum operating power of 100% with overdrive protection at 110%.

9. Web Interface

The following pages outline the steps required to access the Technalogix Adrenaline Web Interface. Descriptions specific to the user's computer, router, or network setup are limited due to the differences in the multitude of networking equipment.

1. **Connect Power Amplifier/Transmitter to your Network/PC**

Connect an Ethernet cable from the RJ45 port (labelled ETH / SNMP) on the back panel of the power amplifier to your network's Ethernet connection. Most new computers can do this with a standard Ethernet cable but older network cards may require a crossover Ethernet cable.

If preferred in place of the screen, a computer can be plugged directly into the Ethernet port on the power amplifier/transmitter to directly access the on-board web interface.

Turn on the transmitter to establish communication with the network.

The Adrenaline control system in the power amplifier or transmitter will source an internal IP from your router or you can set this manually (see Optimize User Parameter section).

2. **Open web browser for monitor and control**

The default internal address is <http://adrenaline/index.htm>. Type this default internal address into the URL address bar of your favorite web browser. The web pages cannot be accessed until you have established basic communication with the power amplifier (turned on).

2.1. **Web Page Password Protection**

After entering the above internal address into a web browser, you will be asked for a password. Initially, please use the following:

username: admin
password: admin

The password can later be changed (see *Optimize user parameters* section).

2.2. Main Page Description

After entering the login information, the main page is then shown on the browser, as illustrated below for either single amplifier systems or multiple amplifier systems that are combined:

TECHN^ALOGIX.
BROADCAST WEB INTERFACE

[Main](#) [Network Configuration](#) [SNMP Configuration](#) [Password Configuration](#)

Model Number: TXV-1000
Serial Number: 06220696

| COMBINER | | Performance: | | | | Control: |
|-------------------------------------|----------------|--------------------|------|---------|--|--|
| Status Flags: | | Combined | | | | |
| <input checked="" type="checkbox"/> | Carrier On/Off | Forward RF Level | 96 | % FS | | <input type="button" value="TURN CARRIER OFF"/> |
| <input checked="" type="checkbox"/> | RF Overdrive | Reflected RF Level | 0 | % FS | | <input type="button" value="AGC TARGET +1"/> |
| <input checked="" type="checkbox"/> | VSWR | DC Pallet Voltage | 29 | Volts | | <input type="button" value="AGC TARGET -1"/> |
| <input checked="" type="checkbox"/> | Pallet Voltage | RF Input Level | 94 | % FS | | <input type="button" value="AGC TARGET +10"/> |
| <input checked="" type="checkbox"/> | RF In Level | Temperature | 36 | Celcius | | <input type="button" value="AGC TARGET -10"/> |
| <input checked="" type="checkbox"/> | Temperature | Driver Current | 3.7 | A | | <input type="button" value="TURN AGC ON"/> |
| <input checked="" type="checkbox"/> | AGC Mode | Final 1 Current | 14.1 | A | | VSWR <input type="button" value="↓"/> <input type="button" value="↑"/> |
| | | Final 2 Current | 14.1 | A | | <input type="button" value="RESET"/> |
| | | Final 3 Current | 14.5 | A | | |
| | | Final 4 Current | 14.3 | A | | |
| | | VSWR Trip Point | 1.8 | | | |
| | | AGC Set Point | 100 | | | |

Single Amplifier System

TECHN^ALOGIX.
BROADCAST WEB INTERFACE

[Main](#) [Network Configuration](#) [SNMP Configuration](#) [Password Configuration](#)

Model Number: TXV-2000
Serial Number: 06320696

| COMBINER | | Performance: | | | | | Control: | |
|-------------------------------------|----------------|--------------------|------|------|------|---------|----------|--|
| Status Flags: | | Combined | PA 1 | PA 2 | | | | |
| <input checked="" type="checkbox"/> | Carrier On/Off | Forward RF Level | 100 | 99 | 96 | % FS | | <input type="button" value="TURN CARRIER OFF"/> |
| <input checked="" type="checkbox"/> | RF Overdrive | Reflected RF Level | 0 | 0 | 0 | % FS | | <input type="button" value="AGC TARGET +1"/> |
| <input checked="" type="checkbox"/> | VSWR | DC Pallet Voltage | 29 | 30 | 29 | Volts | | <input type="button" value="AGC TARGET -1"/> |
| <input checked="" type="checkbox"/> | Pallet Voltage | RF Input Level | - | 95 | 93 | % FS | | <input type="button" value="AGC TARGET +10"/> |
| <input checked="" type="checkbox"/> | RF In Level | Temperature | 29 | 33 | 36 | Celcius | | <input type="button" value="AGC TARGET -10"/> |
| <input checked="" type="checkbox"/> | Temperature | Driver Current | - | 3.7 | 3.7 | A | | <input type="button" value="TURN AGC ON"/> |
| <input checked="" type="checkbox"/> | AGC Mode | Final 1 Current | - | 14.3 | 14.1 | A | | VSWR <input type="button" value="↓"/> <input type="button" value="↑"/> |
| | | Final 2 Current | - | 14.1 | 14.3 | A | | <input type="button" value="RESET"/> |
| | | Final 3 Current | - | 14.5 | 14.5 | A | | |
| | | Final 4 Current | - | 14.3 | 14.3 | A | | |
| | | VSWR Trip Point | 1.8 | | | | | |
| | | AGC Set Point | 100 | | | | | |

Multiple Amplifier System

The model number and serial number of the unit are displayed in the top left of the browser screen.

The Status Flags section provides the user with feedback from the system. Specifically, there are status flags for:

- RF Carrier is on or off
- Forward RF in Overdrive (>110% Full Scale (FS))
- Pallet Voltage Supply Good
- High VSWR
- RF In Level Good
- High Temperature
- AGC on or off (AGC or Manual mode)

The Performance section provides the user with specific parameters and measurements in the system. Measurements that can be viewed from the Performance box are:

- Forward RF Levels as a % of Full Scale (FS)
- Reflected RF Levels as a % of FS
- DC Supply Voltage in volts
- RF Input Levels before attenuator as a % of FS
- Temperature in °C
- VSWR Trip Point Limit

The Control section of the web interface screen allows the user to control functions inside the equipment, including:

- Turn Carrier On/Off - Turn the Carrier on/off
- Carrier Up - Increase the Carrier by removing attenuation
- Carrier Down - Decrease the Carrier by adding attenuation
- Turn AGC On/Off - Turns on the AGC (automatic gain control). The system will then try to maintain the current forward level.
- VSWR $\uparrow\downarrow$ - Increase or Decrease the VSWR Trip point by 0.1 between 1.1:1 and factory determined limit.
- Reset - Forces the system to reboot

Note that if AGC is enabled and you press Carrier Up/Down the system will reset the AGC to manual, make the change in power, and then revert back into AGC mode with the new level. AGC level is maintained if the power amplifier restarts.

3. Optimize user parameters

Also on the main web Ethernet page, along the top, are links to the other user parameter pages:

- Main – Returns to Main Index page
- Network Configuration
- SNMP Configuration
- Password Configuration

3.1. Network Configuration

The Network Configuration page allows the administrator to optimize the network settings to best suit their application.

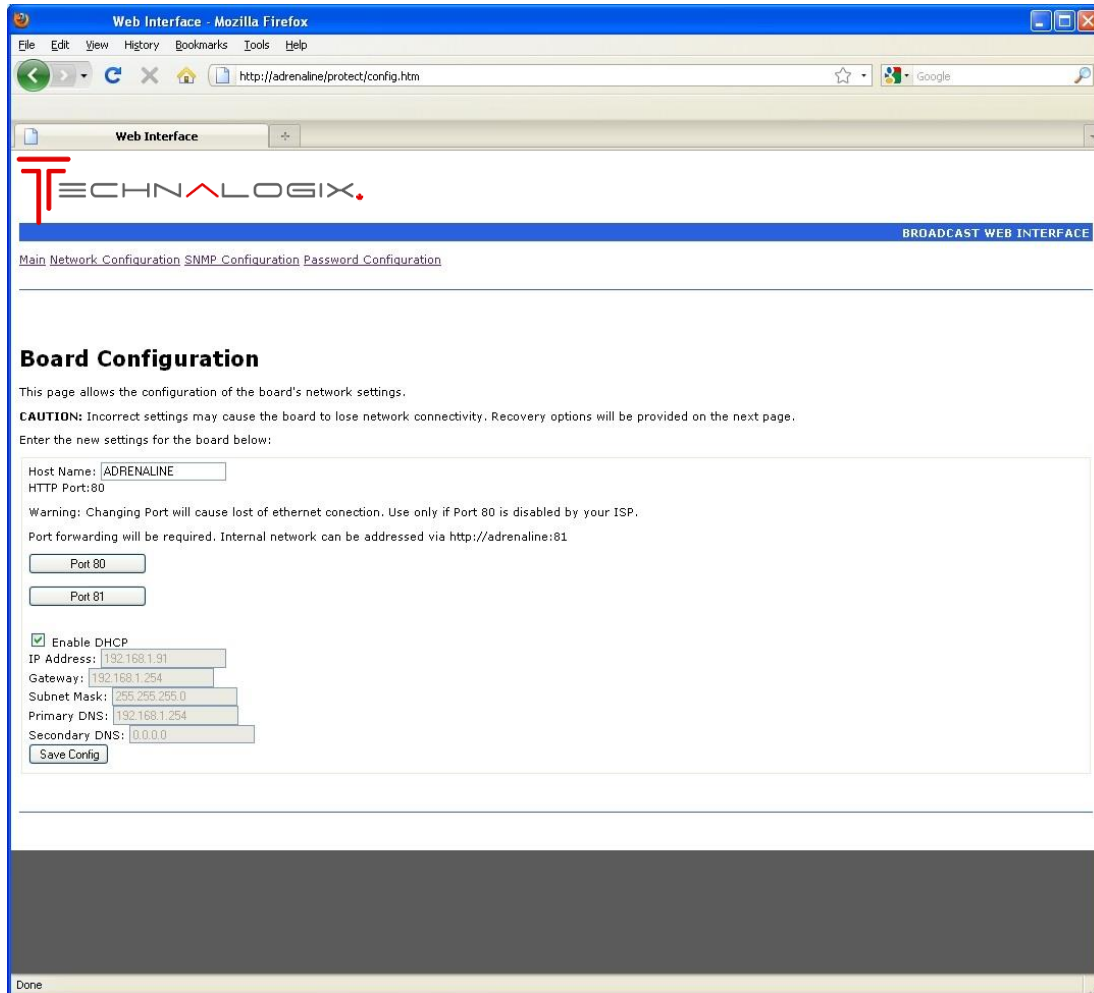

3.1.1. Host Name

The Host Name shows the current webpage name (default is ADRENALINE). Enter a new name here if you wish to change this.

For example, entering YourCompany will make the web address:

<http://yourcompany/index.htm>

3.1.2. HTTP Port

The HTTP Port shows the current port used for internet access, 80 or 81. Port 80 is the default and is the accepted standard. Port 81 is available because some internet providers block access to port 80 unless you pay more.



Be very careful changing HTTP ports as it can be difficult to go back to an original port.

You can force a web browser to use port 81 by address to:

<http://adrenaline:81/index.htm>

To use this with an internet address will require port forwarding. Consult your routers manual to set this up.

3.1.3. IP Addressing

With DHCP enabled the system will automatically try to find a router and acquire an IP address. If you want to set this manually, uncheck the Enable DHCP box and enter it below then click Save Config.

To view the webpage from the internet rather than an internal network you need an external IP address, generally provided by your internet provider. Note that you can only have one web server using the same port. With this, anyone can access the system over the internet with something like:

<http://www.yourcompanywebaddress.com/adrenaline>

3.2. SNMP Configuration

3.2.1. SNMP Communities

The SNMP Configuration page allows you to set the SNMP communities. Set these to limit access to the system via SNMP.

Default communities are:

| | |
|--------|----------------------------|
| READ: | Public Read |
| WRITE: | Private Write Public |

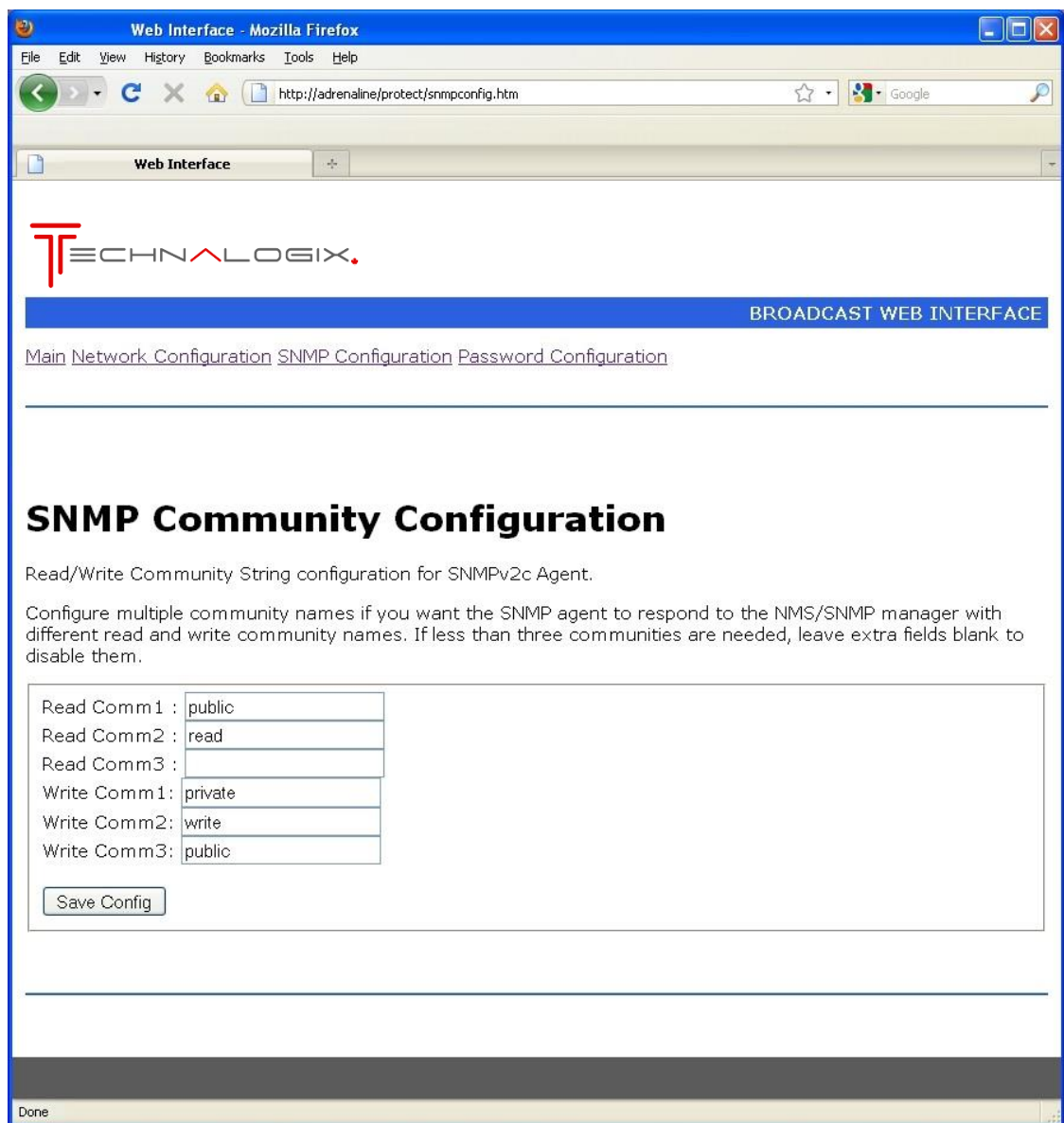

3.2.2. SNMP Management Information Base (MIB)

The MIB file allows access to the following data via the SNMP protocol:

Read Only

| | |
|-------------------------|---|
| Dip switch Setting | - 8 bit value from dipswitch |
| Pallet Supply Voltage | - voltage level (Vdc) |
| Temperature | - temperature in (°C) |
| 12V Current | - current on 12V bus (Adc) |
| 48V Current | - current on high voltage bus (Adc) |
| Attenuation | - attenuation level |
| Forward Level | - forward level as % rated full scale |
| Reflected Level | - reflected level as % rated full scale |
| RF Input Level | - input level as % rated full scale |
| RF Fault | - hardware fault flag |
| Run Time | - time since start up or reset |
| Serial Number | |
| Model Number | |
| SNMP Error Flag | - error flag, also for trap (see below) |
| VSWR Flag | - error flag for high VSWR |
| Overdrive | - error flag for overdrive |
| Temperature Flag | - error flag for high temperature |
| pAEnclosureFWD1 | - Forward power level PA Enclosure 1 |
| pAEnclosureRFL1 | - Reflected power level PA Enclosure 1 |
| pAEnclosureTemperature1 | - Temperature PA Enclosure 1 |
| pAEnclosureRFIn1 | - Input power level PA Enclosure 1 |
| pAEnclosureVoltage1 | - Supply voltage level PA Enclosure 1 |
| pAEnclosureFWD2 | - Forward power level PA Enclosure 2 |
| pAEnclosureRFL2 | - Reflected power level PA Enclosure 2 |
| pAEnclosureTemperature2 | - Temperature PA Enclosure 2 |
| pAEnclosureRFIn2 | - Input power level PA Enclosure 2 |
| pAEnclosureVoltage2 | - Supply voltage level PA Enclosure 2 |

Read/Write

| | |
|----------------|--|
| AGC Goal | - read/write 1-100% |
| AGC mode | - 1 AGC on 0 AGC off |
| Reset | - 1 Reset System 0 Normal |
| Carrier On/Off | - 1 Carrier On 0 Carrier Off |
| Carrier Up | - 1 Increase Carrier Level for AGC target 1% |
| Carrier Down | - 1 Decrease Carrier Level for AGC target 1% |

Read and Write communities can be set from the web interface, as described earlier in this section.

3.2.3. SNMP Traps

To enable the SNMP traps, within the MIB browser that you choose:

- Set enable traps to 1 (or yes, depending on MIB browser).
- Set the IP address to that of the receiving computer.
- Set the community to one of the read communities set above.

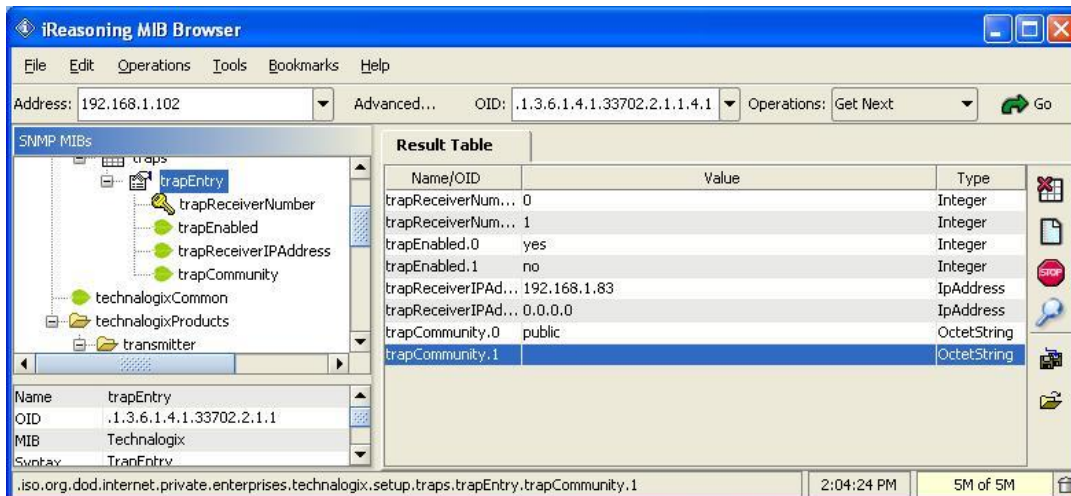
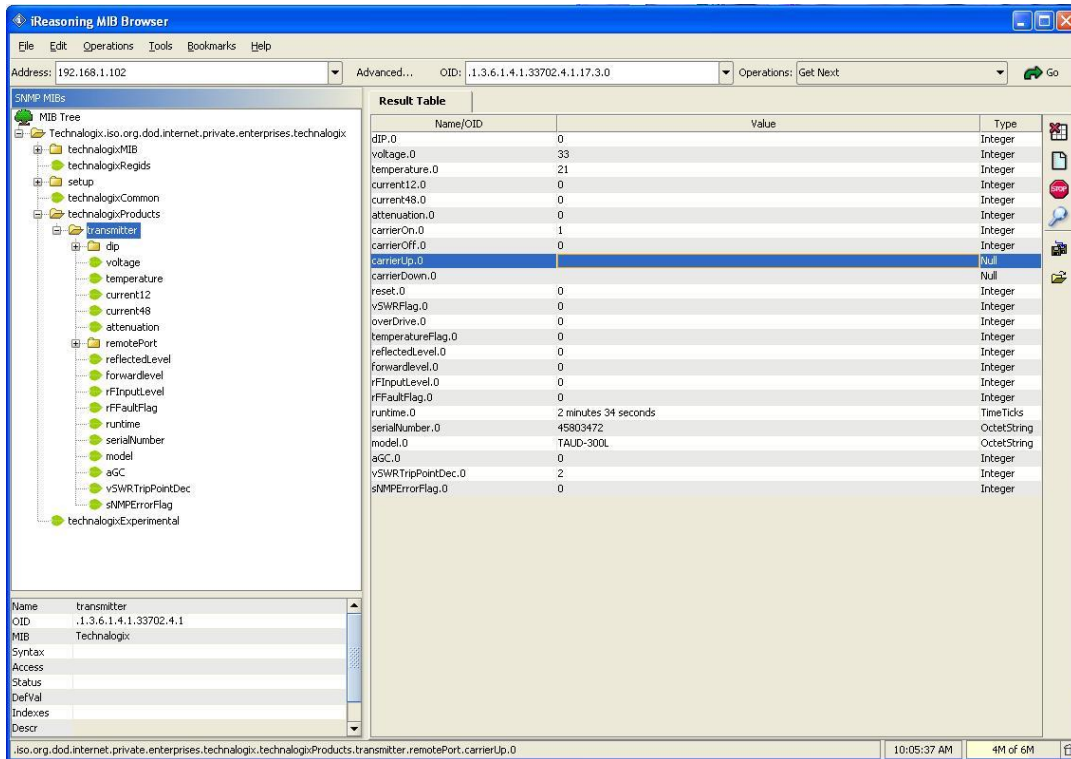

Make sure that your receiver's port is set to 162

The system will generate a general trap on any error flag and send an 8-bit value indicating the type of error, as follows:

| | |
|------------|------------------------------|
| Bit 0(LSB) | Overdrive |
| Bit 1 | High VSWR |
| Bit 2 | High Temperature |
| Bit 3 | High Speed Hardware Shutdown |
| Bit 4(MSB) | High Input Level |

As an example, the following is a screen shot of a high temperature fault (Value 4).

The screenshot shows the 'Trap Receiver' application window. The window title is 'Trap Receiver'. It has a menu bar with 'Operations' and 'Tools'. Below the menu bar is a toolbar with icons for 'stop', 'refresh', and 'options'. The main area is divided into a table and a details section.

| Description | Source | Time |
|---------------------------------|---------------|------------------------------|
| Specific: 1; .1.3.6.1.4.1.33702 | 192.168.1.102 | Thu Sep 16 15:11:40 MDT 2010 |
| Specific: 1; .1.3.6.1.4.1.33702 | 192.168.1.102 | Thu Sep 16 15:11:36 MDT 2010 |

Source: 192.168.1.102
Timestamp: 1 minute 55 seconds
Enterprise: .1.3.6.1.4.1.33702
SNMP Version: 1
Specific: 1
Generic: enterpriseSpecific

Variable Bindings:

| | |
|---------------|-----------------------------|
| Name: | .1.3.6.1.4.1.33702.4.1.37.0 |
| Value: | (Integer)4 |

Description:

3.3. Password Configuration

This page allows the setting of the web browser's User or Admin password, as illustrated below.

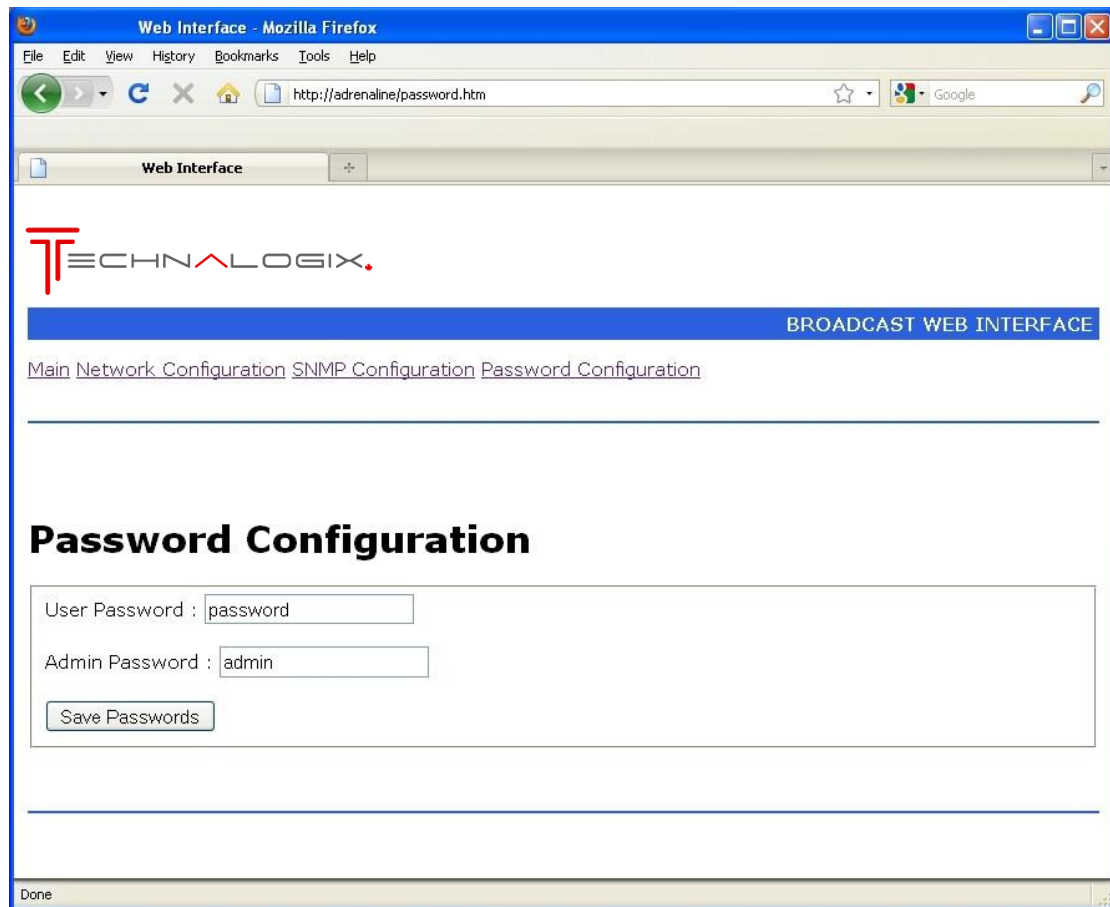

The User account allows access only to the main page. The Admin account allows access to the main and all the configuration pages.

Passwords are to be a maximum of 7 characters long. Don't forget your password. Resetting your password may cause a loss of all settings.

9.1. Remote Control (via DB25)

An additional option for remote control of the power amplifier/transmitter is through the DB25 connector found on the back panel of the power amplifier/transmitter

The overall functions of each pin on the Remote Port are indicated in the following DB25 pinout:

| Pin Number | Description |
|----------------|---|
| 1 | Ground |
| 2 | Forward power sample ¹ |
| 3 | Reflected power sample ¹ |
| 4 | Carrier off ² |
| 5 | Carrier on ² |
| 6 ³ | Increase carrier level 1%, if AGC on ² |
| 7 ³ | Decrease carrier level 1%, if AGC on ² |
| 8 | Do not use |
| 9 | Reset ² |
| 10 | Do not use |
| 11 | High temperature flag ² |
| 12 | High VSWR flag ² |
| 13 | Amplifier overdriven flag ² |
| 14 | Do not use |
| 15 | +3.3Vdc (for testing only, do not load) |
| 16 | Ground |
| 17 | Ground |
| 18-25 | Do not use |

- Notes:
1. Analog output with voltage ranging from 0 to 3.3Vdc.
 2. Open collector configuration on RF 1.04 and later. On RF 1.04 and later, ground to activate input control on inputs; ground indicates fault occurrence on fault outputs. On RF 1.03 and earlier, the inputs are TTL digital inputs, active on rising edge and the outputs are active high.
 3. If AGC off, these pins turn on AGC to the current FWD level, +/- 1%.

In addition to the DB25 parallel data connector, the user may chose to remotely control the RF amplifier via an optional Ethernet web server or through an optional Simple Network Managed Protocol (SNMP) interface, described later in this section.

9.2. Combiner Control

In higher power systems that contain more than one power amplifier enclosure, there also is a combiner enclosure to combine the individual outputs of all of the power amplifier enclosures. This combiner enclosure also monitors the total power of the overall system. The following is a brief description of the operation of the monitor system found in the combiner unit, if applicable.

| | |
|-------------------------------|---|
| Carrier On/Off | Turning the carrier on or off can be done from the touch screen or the remote port on any power amplifier or the combiner enclosure. It can also be done from SNMP or the Ethernet interface which should be connected to the combiner enclosure. This will turn the carrier off for the whole system. |
| Carrier Up/Down | The power level can be adjusted from the touch screen (RF Levels screen) or the Remote Port on any power amplifier or the combiner enclosure. It can also be done from the SNMP or Ethernet interface which should be connected to the combiner enclosure. This will add or subtract attenuation on the individual power amplifier enclosures to achieve an overall change in carrier level, and sets the AGC to the new levels if the AGC mode is enabled. |
| AGC mode | AGC mode can be turned on or off from the touch screen (RF Levels screen) or the Remote Port on any power amplifier or the combiner enclosure. It can also be done from the SNMP or Ethernet interface which should be connected to the combiner enclosure. This will cause all the amplifier boxes to try and maintain the current forward power level. |
| Temperature, Voltage, Current | Temperature, voltage, and current readings on the enclosure's touch screen are for that unit only. The SNMP and Ethernet interface will show each unit's readings separately, and should be connected to the combiner enclosure. |
| Forward & Reflected Power | Forward and reflected power shown on the touch screen or the Remote Port are for that power amplifier enclosure only, or show the total combined power if it is on the combiner enclosure. The SNMP and Ethernet interface will show each unit's readings separately, and should be connected to the combiner enclosure. |
| Display Units | Changing the temperature or power units on one enclosure won't change the display units on other enclosures. They will all have to be changed individually. |
| VSWR Trip point | The VSWR trip point between 1.1 and 1.8 can be changed from the touch screen (RF Levels screen) on any power amplifier or the combiner enclosure. It can also be done from the SNMP or Ethernet interface which should be connected to the combiner enclosure. This will change the trip point for all the units. |
| Errors | An error that causes one enclosure to shutdown will cause the other enclosures to shutdown. If one power amplifier or the combiner is to fold back its power levels to stay within operating parameters, the others will match that power level. |

9.3. Back Panel Monitoring

In addition to the remote control interfacing through Ethernet, SNMP, and the Remote Port, the back panels on most units also contain additional monitoring achieved through LED status indicators, as seen below:

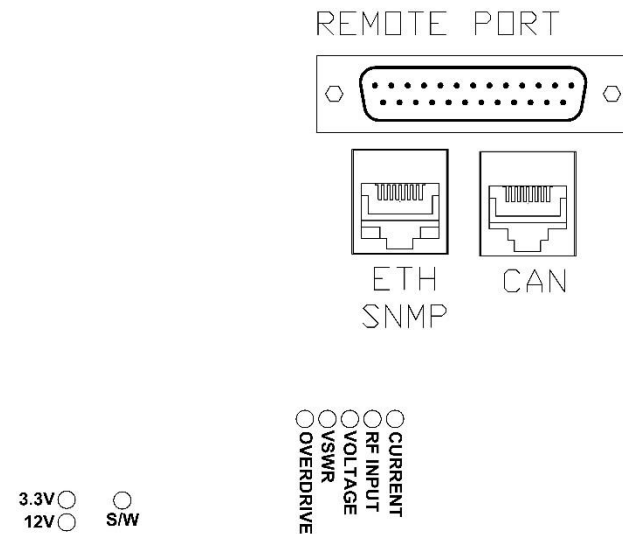

There are (5) fault LEDs, (2) power supply indicator LEDs, and one software LED, as described below.

- CURRENT:** If the RF pallet current draw exceeds factory set levels, the green LED is turned off
- RF INPUT:** If the RF Input level exceeds factory set levels, the green LED is turned off.
- VOLTAGE:** If the DC supply voltage for the amplifier pallets drops below a factory set level, the green LED turns off.
- VSWR:** If the reflected power level into the amplifier exceeds either the user set trip point of the factory set maximum, the green LED turns off.
- OVERDRIVE:** If the forward power exceeds the factory set limit, the green LED will turn off.
- 3.3V:** Control system 3.3V supply rail.
- 12V:** Control system 12V supply rail.
- S/W:** A green S/W LED indicates that the control system software is operating.

10. Monitor and Control System

10.1. Control System Overview

The control system is used for a variety of functions, the most important of which is ensuring that the amplifier continues to operate in a safe manner. The control system also allows the user to monitor and control the amplifier or transmitter from both the front panel and remotely through the parallel port, or Ethernet.

The control system is comprised of three (3) modules. These modules work together to provide all the functions of the control system and include Display Interface, RF Control, and Temperature Sensor modules. In higher power/multiple pallet systems, a DC Distribution module is included.

10.1.1. System Block Diagram – 1 Amplifier

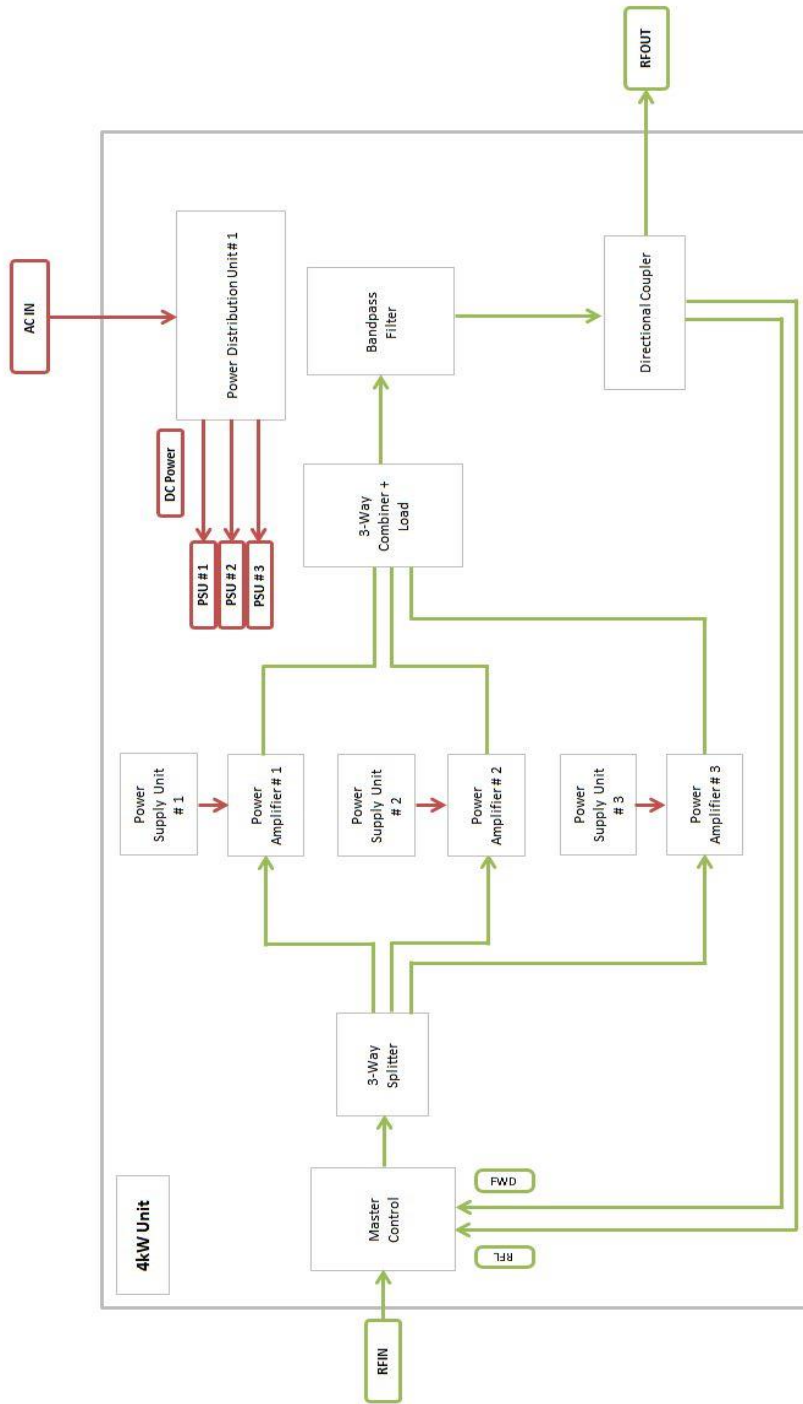

10.1.2. Adrenaline Block Diagram

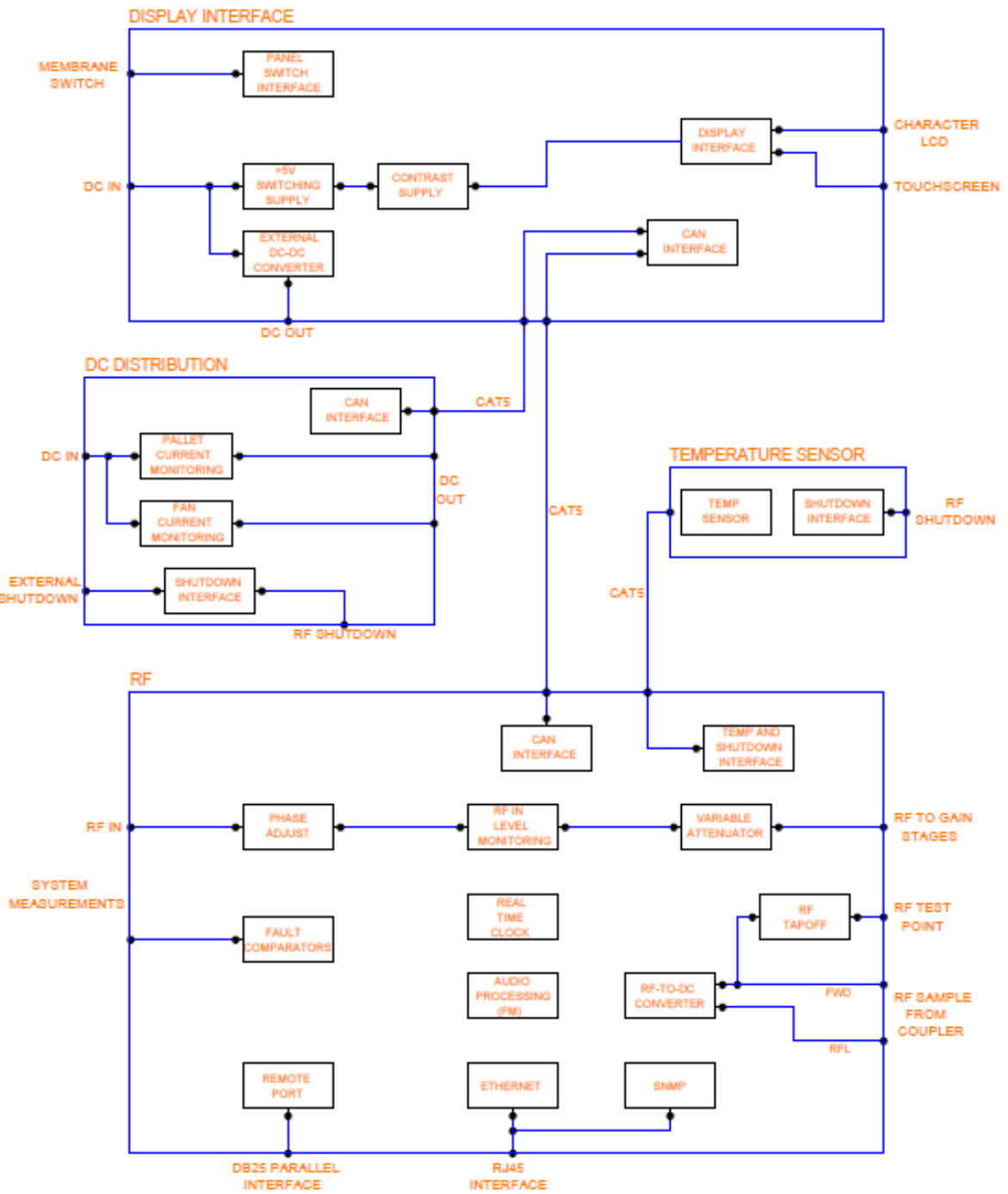

10.2. RF Module

The RF PCB module is located on the back panel of the power amplifier enclosure(s) and has several primary functions:

- act as a variable attenuator so the control system can add attenuation to the RF input of the power amplifier in order to limit the output power of the RF amplifier,
- provide additional gain, if required, before passing the RF signal onto the amplifier chain,
- monitor the output of the directional coupler which provides a voltage proportional to the forward and reflected power at the output of the RF amplifier,
- communicate with the Temperature Sensor module(s) to read heatsink temperatures and provide a link to the driver shutdown through the temperature sensor PCB, and
- provide external remote operation to the user through parallel data, Ethernet, and SNMP interfaces.

10.3. Display Interface Module

The primary function of the Display Interface module is, as the name suggests, providing the display and user interface for the control system. This circuit board is mounted behind the front panel of the power amplifier enclosure(s) in the amplifier system, near the 4.3" touchscreen display. All switch/settings and user interface is handled through the resistive touchscreen. The touchscreen on the front panel is connected to the Display Interface PCB through a cable.

These components provide the user with the ability to monitor the following power amplifier parameters from the front panel:

- Forward (incident) power at the power amplifier output.
- Reflected (reverse) power at the power amplifier output.
- DC voltage of the power amplifier's power supply.
- DC current in the power amplifier.
- Temperature of the heat sink of the power amplifier.
- The time since the amplifier was last shut down.
- History of faults and events
- Mode of the power amplifier (selectable between Manual and AGC).
- Indication if there is attenuation added to the front end of the power amplifier indicating fold back in RF power (indicates amount of attenuation)
- Settings to change the VSWR trip point shutdown between 1.1:1 and 1.8:1.
- Settings to change the RF power units between % power (maximum of 110%) or watts.
- Summary of PCB modules and assembly numbers specific to the power amplifier

10.4. Temperature Sensor Module

The Temperature Sensor module is a small board mounted to the main heatsink of the amplifier. The purpose of the temperature sensor module is to take temperature readings of the heatsink. The temperature is monitored by the system to trigger shutdown in case of overheating.

In custom applications, there may be multiple temperature sensors installed onto a heatsink or throughout the system.

10.5. DC Distribution Module

The DC Distribution module takes DC from the system's power supply, splits it up for drivers, finals, and fans, and monitors the current draw of the individual loads for protection

11. Hardware Components

11.1. RF Amplifier Pallet

The exact bias and drain current of your system are found in the Final Inspection Report supplied in the shipping package. Output power levels are absolute maximum levels. Technalogix operates the pallet at reduced levels to improve performance and increase reliability.

Predriver: VHFTV3-25D-40-50V

| | |
|--------------------|-------------|
| Typical gain | 36 dB |
| Input Power (typ) | 7dBm |
| Output Power (max) | 30W |
| Frequency | 170-230 MHz |
| ID (max) | 3 Adc |
| VD (max) | 50 Vdc |



Driver: P1200XR-B3TV

| | |
|--------------------|-------------|
| Typical gain | 21 dB |
| Input Power (max) | 3W |
| Output Power (max) | 600 W |
| Frequency | 170-230 MHz |
| ID (max) | 28 Adc |
| VD (max) | 50 Vdc |



11.2. Coupler

The coupler is used to detect forward and reflected powers.

C-DC2A23/2B-B009

| | |
|--------------------|-------------------|
| Frequency Range | 174 - 240 MHz |
| Coupling Range | -35 to -55dB |
| Output Power (max) | 4700 W continuous |
| Directivity | >32 dB |
| Return Loss | >36 dB |



11.3. RF Combiner

The combiner is used to sum the power from multiple amplifier pallets

3-Way VHF Band-III Combiner

| | |
|-----------------------------|---------------|
| Frequency Range | 174 - 230 MHz |
| Analog TV peak sync | 3500W (max) |
| Input ports (3) return loss | -25dB |
| Common port return loss | -20 dB |
| Insertion loss (S12/S21) | -5dB |
| Phase unbalance | 2° (max) |

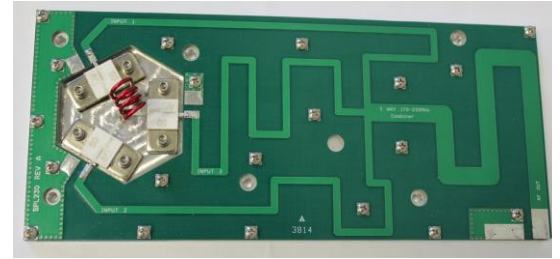

11.4. Bandpass Filter

The bandpass filter is used to transmit or pass power generated only for a particular range of frequencies.

A-TC6D140B/A

| | |
|-----------------------|---------------|
| Frequency Range | 174 - 240 MHz |
| Max RMS Input Power | 4400W |
| Insertion Loss | ~0.32dB |
| Harmonic Attenuation | >50dB |
| Return Loss/VSWR | >26dB / <1.11 |
| Group Delay Variation | <240ns |

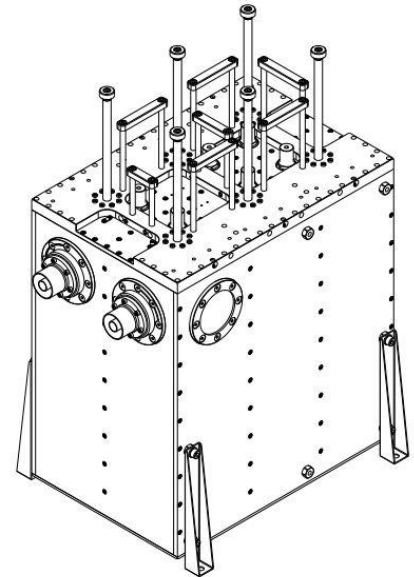

11.5. Power Supply

Switching AC-DC power supplies are used to power the amplifier pallets, the control circuits, and all of the fans. The DC system voltage is set at either 28 or 48Vdc nominally, depending on the system. All fans run off this same DC supply. The specific DC system voltage is found in the Final Inspection Report.

AC is fed into the power supply enclosure via a filtered AC entry and then through a circuit breaker/switch. Specific AC current draw is documented in the Final Inspection Report. AC is then converted to DC using one or more AC-DC switching power supplies.

The following is the switching power supply data sheet(s) used to convert the AC to DC for the internal amplifier or transmitter components.



3000W Single Output Power Supply

RSP-3000 series



■ Features :

- AC input 180 ~ 264VAC
- AC input active surge current limiting
- High efficiency up to 90%
- Built-in active PFC function, PF>0.95
- Protections: Short circuit / Overload / Over voltage / Over temperature / Fan alarm
- Forced air cooling by built-in DC with fan speed control function
- Output voltage can be trimmed between 20~110% of the rated output voltage
- High power density 15.6W/inch³
- Current sharing up to 3 units
- Alarm signal output (relay contact and TTL signal)
- Built-in 12V/0.1A auxiliary output for remote control
- Built-in remote ON-OFF control
- Built-in remote sense function
- 5 years warranty



SPECIFICATION

| MODEL | RSP-3000-12 | RSP-3000-24 | RSP-3000-48 | |
|-----------------------|--|--|--------------|----------------|
| OUTPUT | DC VOLTAGE | 12V | 24V | 48V |
| | RATED CURRENT | 200A | 125A | 62.5A |
| | CURRENT RANGE | 0 ~ 200A | 0 ~ 125A | 0 ~ 62.5A |
| | RATED POWER | 2400W | 3000W | 3000W |
| | RIPPLE & NOISE (max.) Note.2 | 150mVp-p | 150mVp-p | 200mVp-p |
| | VOLTAGE ADJ. RANGE | 10.8 ~ 13.2V | 22 ~ 28V | 43 ~ 56V |
| | VOLTAGE TOLERANCE Note.3 | ±1.0% | ±1.0% | ±1.0% |
| | LINE REGULATION | ±0.5% | ±0.5% | ±0.5% |
| | LOAD REGULATION | ±0.5% | ±0.5% | ±0.5% |
| | SETUP, RISE TIME | 1000ms, 80ms at full load | | |
| HOLD UP TIME (Typ.) | 10ms at full load | | | |
| INPUT | VOLTAGE RANGE | 180 ~ 264VAC | 254 ~ 370VDC | |
| | FREQUENCY RANGE | 47 ~ 63Hz | | |
| | POWER FACTOR (Typ.) | 0.95/230VAC at full load | | |
| | EFFICIENCY (Typ.) | 86% | 89.5% | 90.5% |
| | AC CURRENT (Typ.) | 20A/180VAC | 16A/230VAC | |
| | INRUSH CURRENT (Typ.) | 60A/230VAC | | |
| LEAKAGE CURRENT | <2.0mA / 240VAC | | | |
| PROTECTION | OVERLOAD | 100 ~ 112% rated output power User adjustable continuous constant current limiting or constant current limiting with delay shutdown after 5 seconds, re-power on to recover | | |
| | OVER VOLTAGE | 13.8 ~ 16.8V | 28.8 ~ 33.6V | 57.6 ~ 67.2V |
| | OVER TEMPERATURE | Shut down o/p voltage, recovers automatically after temperature goes down | | |
| FUNCTION | AUXILIARY POWER(AUX) | 12V@0.1A(Only for Remote ON/OFF control) | | |
| | REMOTE ON/OFF CONTROL | Please see the Function Manual | | |
| | ALARM SIGNAL OUTPUT | Please see the Function Manual | | |
| | OUTPUT VOLTAGE TRIM Note.5 | 2.4 ~ 13.2V | 4.8 ~ 28V | 9.6 ~ 56V |
| | CURRENT SHARING | Please see the Function Manual | | |
| ENVIRONMENT | WORKING TEMP. | -20 ~ +70°C (Refer to "Derating Curve") | | |
| | WORKING HUMIDITY | 20 ~ 90% RH non-condensing | | |
| | STORAGE TEMP., HUMIDITY | -40 ~ +85°C, 10 ~ 95% RH | | |
| | TEMP. COEFFICIENT | ±0.05%/°C (0 ~ 50°C) | | |
| SAFETY & EMC (Note 4) | VIBRATION | 10 ~ 500Hz, 2G 10min./1cycle, 60min. each along X, Y, Z axes | | |
| | SAFETY STANDARDS | UL60950-1, TUV EN60950-1 approved | | |
| | WITHSTAND VOLTAGE | I/P-O/P:3KVAC | I/P-FG:2KVAC | O/P-FG:0.5KVAC |
| | ISOLATION RESISTANCE | I/P-O/P, I/P-FG, O/P-FG:100M Ohms / 500VDC / 25°C / 70% RH | | |
| | EMC EMISSION | Compliance to EN55022 (CISPR22) Conduction Class B, Radiation Class A; EN61000-3-2,-3 | | |
| OTHERS | EMC IMMUNITY | Compliance to EN61000-4-2,3,4,5,6,8,11, EN55024, light industry level, criteria A | | |
| | MTBF | 104.5K hrs min. MIL-HDBK-217F (25°C) | | |
| | DIMENSION | 278*177.8*63.5mm (L*W*H) | | |
| | PACKING | 4Kg; 4pcs/16Kg/1.89CUFT | | |
| NOTE | <p>1. All parameters NOT specially mentioned are measured at 230VAC input, rated load and 25°C of ambient temperature.</p> <p>2. Ripple & noise are measured at 20MHz of bandwidth by using a 12" twisted pair-wire terminated with a 0.1uF & 47uF parallel capacitor.</p> <p>3. Tolerance : includes set up tolerance, line regulation and load regulation.</p> <p>4. The power supply is considered a component which will be installed into a final equipment. The final equipment must be re-confirmed that it still meets EMC directives. For guidance on how to perform these EMC tests, please refer to "EMI testing of component power supplies." (as available on http://www.meanwell.com)</p> <p>5. Can't use the PWM signal to control the output voltage.</p> <p>6. PV(PIN3) and PS(PIN4) of CN1 or CN2 must be shorted if "Output Voltage TRIM" function is not used. Otherwise, the power supply unit will have no output.</p> | | | |

File Name:RSP-3000-SPEC 2014-01-14

12. Facility Recommendations

12.1. Building Recommendations

The quality of the building is of great importance if you are to expect long life and continued performance from the power amplifier or transmitter. The building must be clean, dry, temperature controlled and secure. Don't forget to allow space in the building for any additional racks to house test equipment, a workbench area, line regulating transformers, ladders, equipment and parts storage, first aid kit, emergency generator if used, as well as heating and cooling devices that may be unique to your installation. A sloping roof will tend to develop leaks less rapidly. The building should be well roofed with good material. The cooling load will be lowered with reflective or light colored roofing material.

12.2. Electrical Service Recommendations

Technalogix recommends that a qualified, licensed local electrician be consulted for the required electrical service. We suggest local electricians because:

- The personnel know the local codes
- The personnel can be on site readily
- You are apt to get better overall support if you cultivate business relationships with local suppliers

Technalogix recommends that proper AC line conditioning and surge suppression be provided on the primary AC input to the power amplifier or transmitter. If DC is used as a source, a DC-DC converter is recommended to provide isolation between the supply and the load. All electrical service should be installed with your national electrical code in your area, any applicable provincial or state codes, and good engineering practice. Special consideration should be given to lightning protection of all systems in view of the vulnerability of many sites to lightning. Lightning arrestors are recommended in the service entrance. Gas Discharge Tubes (GDT) may help in preventing lightning, which was forecast for another day, from creating a bad day. Straight and short grounds are recommended. The electrical service must be well grounded. Do not connect the unit to an open delta primary power supply, as voltage fluctuations could harm the unit. Branch your circuits. Do not allow your lights, your workbench plugs, and your transmitting or translating equipment to operate on one circuit breaker. Each amplifier or transmitter should have its own circuit breaker, so a failure in one does not shut off the whole installation.

12.3. Antenna and Tower Recommendations

Your preliminary engineering workgroup should establish your antenna and tower requirements, if applicable, both for receiving and transmitting antennas. Construction of sturdy, high quality antenna/tower systems will pay off in terms of coverage of your service area, the overall quality and saleability of your radiated signal, and reduced maintenance expenses. Technalogix provides complete turnkey antenna systems if needed. If your site is serving as a translator, your receiving antenna should be in line of sight to the originating station all year round. Foliage will change with the seasons. Transmitting antennas can enhance or seriously impair the amplifier or transmitter output.

The selection, routing, and length of coaxial cable are extremely important in the installation. If there is a 3 dB line loss in the cable between your unit's output and the transmitting antenna, the unit will only deliver half power. Buy the best cable you can obtain, route it via the shortest way to the antenna, and keep it straight. Do not form it into sharp bends on its way. Do not use any more cable fittings for the installation than absolutely necessary. All cautions here apply equally to all coaxial cables in the system - input and output.

Pay attention to radial ice accumulation when designing the transmission system. It is not uncommon for at least an inch of ice to build up on a tower or antenna in some locations. This in turn significantly increases the weight, cross section, and wind loading of the system, not to mention creating issues from reflective power.

Attaching the transmission line to the tower is crucial to maintain a safe and reliable operation. Nylon wire ties and electrical tape will breakdown in the sunlight and ultimately fail, creating a potentially dangerous situation. It is important to use proper clamps and hoisting grips and also ensure that the transmission line is grounded to the tower in several locations. When high currents flow through the tower in the event of lightning strikes, some of that current will flow through the outer conductors of the transmission lines. Due to the resistance difference between the steel tower and copper transmission line, a significant voltage can be developed, often resulting in arcing between the outer jacket and outer conductor, thus pitting the conductor.

Preventative maintenance is crucial in ensuring that safety is maintained. Specifically, check that transmission line grounds are tight and are not missing any hardware. Frequently inspect support clamps or spring hangers. Consider investing in an ice break, if you haven't already done so, as shards of falling ice can damage the transmission line – and if it is going to happen, it will happen at an important time. Check the tower light photocells and conduit.

The better-known tower manufacturers offer complete technical and safety documentation with their towers. Be sure that you have this information as it regards wind loading, guying, etc. The best-designed antenna system will function poorly if shortcuts and compromises are used during installation. Follow the manufacturer's instructions exactly, along with any engineering data prepared for the site. Be absolutely safe and certain about this aspect as human lives may be at stake.

12.4. Shelter Security

The FCC requires that the equipment be secure from entry or control by unauthorized persons, and that any hazardous voltages or other dangers (including most tower bases) be protected by locks or fences as necessary to protect personnel and prevent unauthorized tampering or operation. Security of the building further implies that it be secure from wildlife. Use sturdy construction materials, including sheet metal if necessary. Holes around conduit, cable, and other similar entry points should be stuffed with steel wool and caulked to prevent entry of wildlife. Other features of security for your shelter may include its location with respect to the prevailing wind conditions. Locations leeward of some natural topographical feature will prevent wind damage and snowdrifts. Check the soil runoff conditions that may slow or hasten wind or water erosion and other concerns that may be unique to your location.

12.5. Heating and Cooling Requirements

The environment's temperature will contribute greatly to the length of the power amplifier's or transmitter's life. Technalogix recommends that the building's filtered air intake must have capacity for all air-flow in the building plus an additional 20%. Keep the intake below the roofline to avoid intake of solar heated air. Please ensure that the intake and exhaust areas are on the same side of the building to avoid pressure differentials during windy conditions. Also, do not position intake near exhaust's preheated air. If air conditioning is required to cool the shelter, discuss the situation with a qualified HVAC technician. Under average conditions, 12,000 BTUs will cool approximately 500 square feet to a comfortable level. The fans internal to the enclosures help cool the components.

13. Maintenance

If your unit employs a filter on the air inlet for the fans, the filter should be cleaned every 30 days. If the equipment is operated in a severe dust environment, the filters on the inlet fan may need to be cleaned more regularly. Turn the system off and unplug all of the AC inlet cords. The filter can be lifted off the fan and cleaned using an air compressor at low pressure. While the filter is out, clean the fan blades with a small brush. The fans themselves do not need lubrication.

The interior of the cabinets should be cleaned and inspected annually. Turn the system off and unplug all of the AC inlet cords. Remove the top lid by unscrewing the 6-32 machine screws.



Use extreme caution when working near the AC input terminal. The power amplifier/transmitter and power supply store hazardous voltages.

Using either compressed air or a brush with soft bristles, loosen accumulated dust and dirt and then vacuum the interior of the cabinet. Complete a visual inspection of the interior, making sure there are no loose connections or discolorations on any components from heat. Nothing inside the power amplifier or transmitter enclosure exceeds a temperature that is not comfortable to the touch under normal operating conditions (unless it is RF!), so any signs of discoloration indicate potential damage.

All modular components inside the enclosure are attached to aluminum or copper mounting plates for easy removal and replacement. Ensure that plates are secured and the mounting hardware is tight.

14. Troubleshooting

The first and most important aspect of troubleshooting anything is to be systematic. Note where you have looked and what you found.

Look first for the obvious.

- Make a physical inspection of the entire facility. Are all necessary connections properly made? Do you see any signs of obvious damage within the equipment?
- Is the AC power 'ON' to the site and the equipment? (Check fuses and circuit breakers if necessary.)
- Are all the switches in the correct operating position?
- Is the input signal present and at the correct level?
- Check display readings for presence of forward and reflected power and DC supply levels.

The following flowcharts are an aid in determining the fault if some aspect of the system is not operating.

AC - DC Power Supply (PSU) Troubleshooting

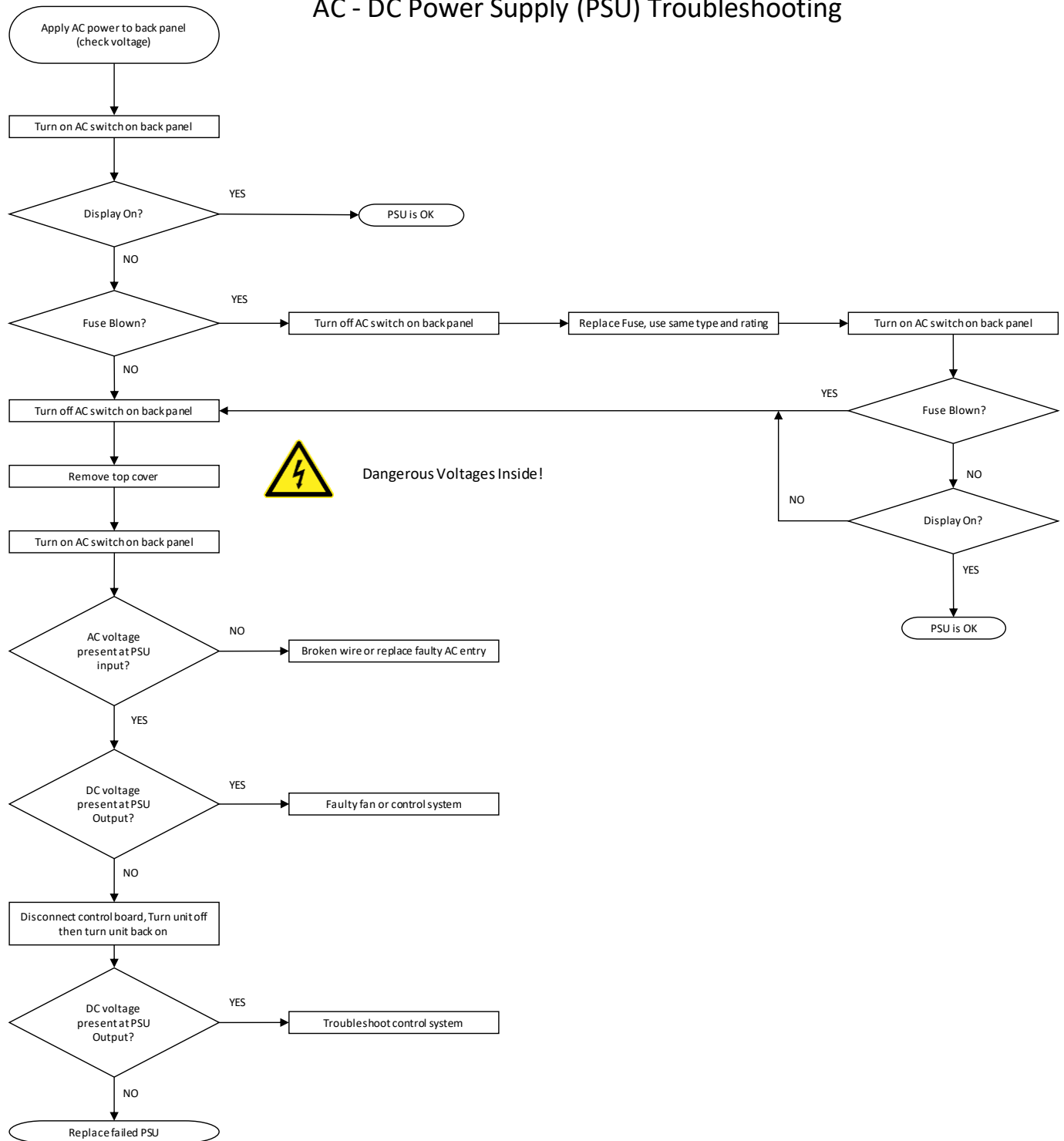

Control System Troubleshooting (1 of 2)

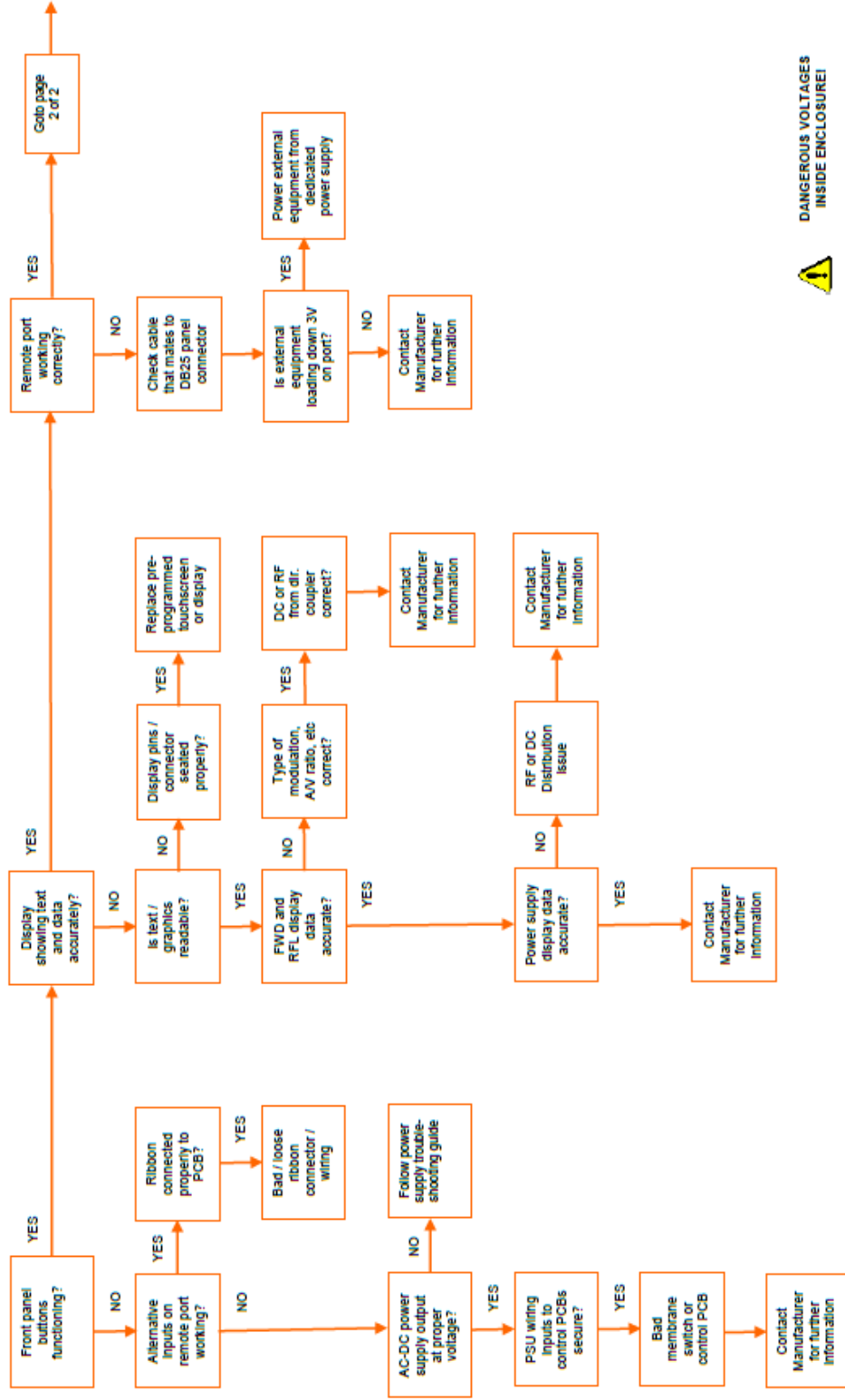

**DANGEROUS VOLTAGES
INSIDE ENCLOSURE!**

Last Updated: 03-May-2016

Control System Troubleshooting (2 of 2)

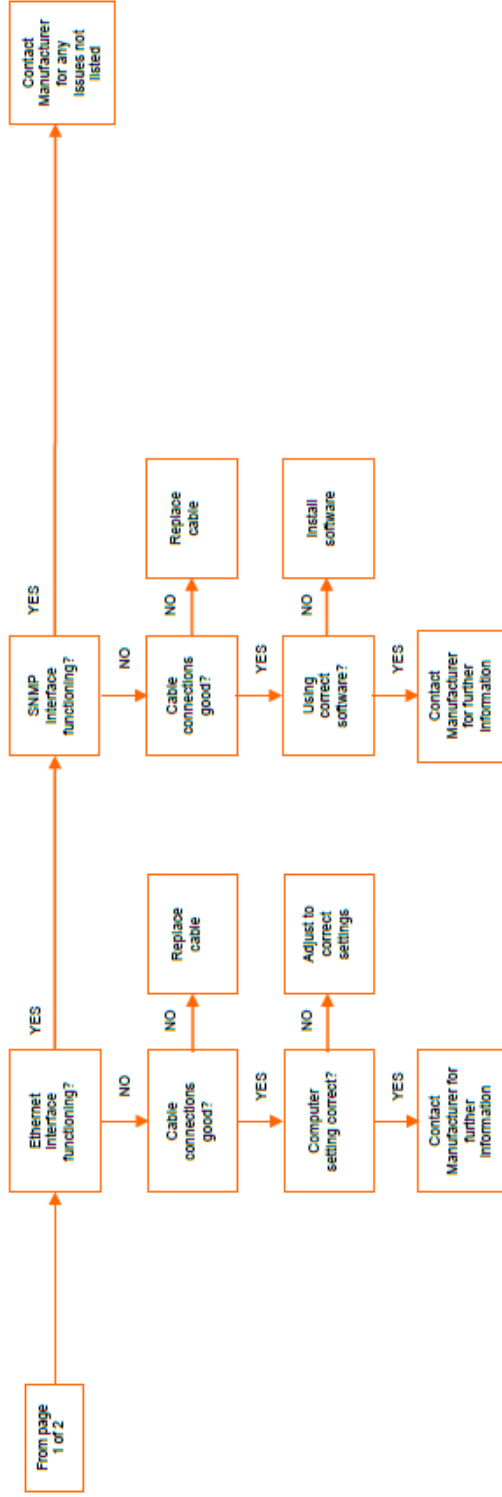

**DANGEROUS VOLTAGES
INSIDE ENCLOSURE!**

Last Updated: 03-May-2016

15. Specifications

| | | |
|---|-----------|---|
| General Data | | |
| Model Number | | TAVD-4000H |
| Frequency | 170-230 | MHz |
| Bandwidth | 6 | MHz (ATSC) |
| Input Signal | +1 | dBm max |
| Output Power | 4000 | W nominal |
| Supply Voltage | 200-240 | V AC |
| Supply Current | 41 | Amps AC typ (per phase) @ full power |
| Operating Temperature Range | -10 to 35 | C, derate output above 25C |
| Relative Humidity | 90 | % noncondensing |
| Harmonic level | -60 | dBc min, with output mask filter |
| MER | 35.9 | dB min, with output mask filter |
| Shoulders | 38 | dB min, with output mask filter |
| | | |
| | | |
| Operation | | |
| Input | | RF input |
| Display | | Color touch screens, Local operation and display |
| Ethernet | | local, remote, standard web browser |
| SNMP | | network management interface via SNMP |
| Remote Interface | | DB25 connector for messages and control |
| Real Time Clock | | 1 week storage of settings |
| History Log | | 10 most recent events stored |
| Shutdown conditions | | Overdrive, high temperature, high VSWR |
| VSWR Alarm | | adjustable 1.1:1 to 1.8:1 |
| Temperature Alarm | | factory adjustable, set to 65 degrees C |
| | | |
| | | |
| Options | | |
| Interlock | | Remote failsafe control of unit |
| Monitor | | Sample of RF output |
| Modulator | | TM800 |
| Automatic Transfer Switch | | TSW-100 for monitoring and selection of modulators. |
| | | |
| | | |
| Standards | | |
| Designed to Industry Canada and FCC standards | | |
| | | Specifications subject to change. |

**Thank you
for choosing
Technalogix Ltd.**

If there is anything we can do to help in your success, please do not hesitate to contact us. We also welcome suggestions for product improvements or feature enhancements.