

VERSION HISTORY	
#	DATE
5.00	23-AUG-18
	NOTES
	ORIGINAL



THIRD ANGLE PROJECTION

TITLE
48 X 30 TALL CASE

SHEET
OVERVIEW

FIASCOCASES.COM

DATE
23-AUG-18

DESIGNED
MATT WATERHOUSE

PROJECT MANAGER
JOE BRADFORD

SCALE | 1:10
PAPER | A4
FILE | 48 X 30 TALL CASE V5.00.dwg
PLOT | 04/11/2019 12:17 PM
SHEET | 1 OF 2

VERSION

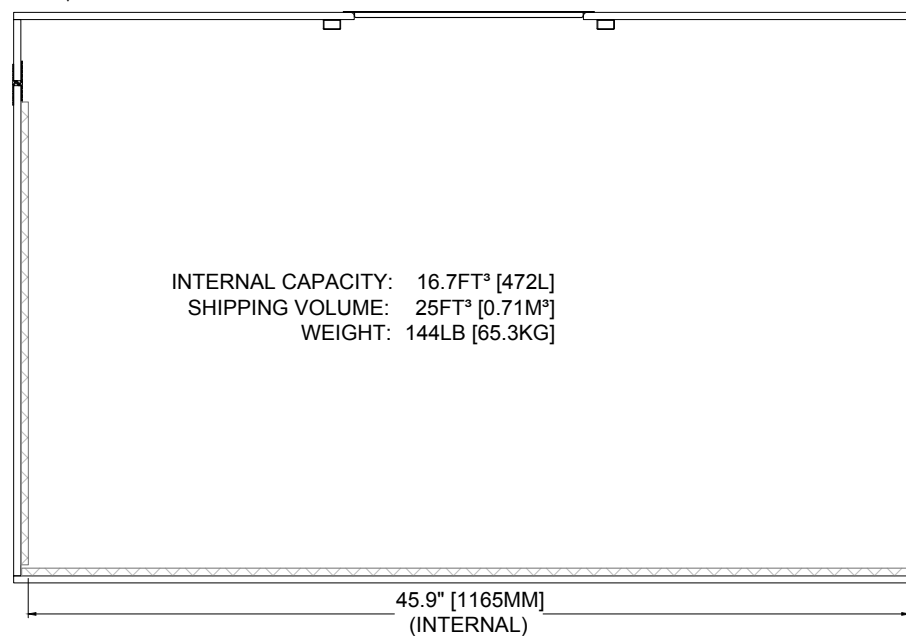
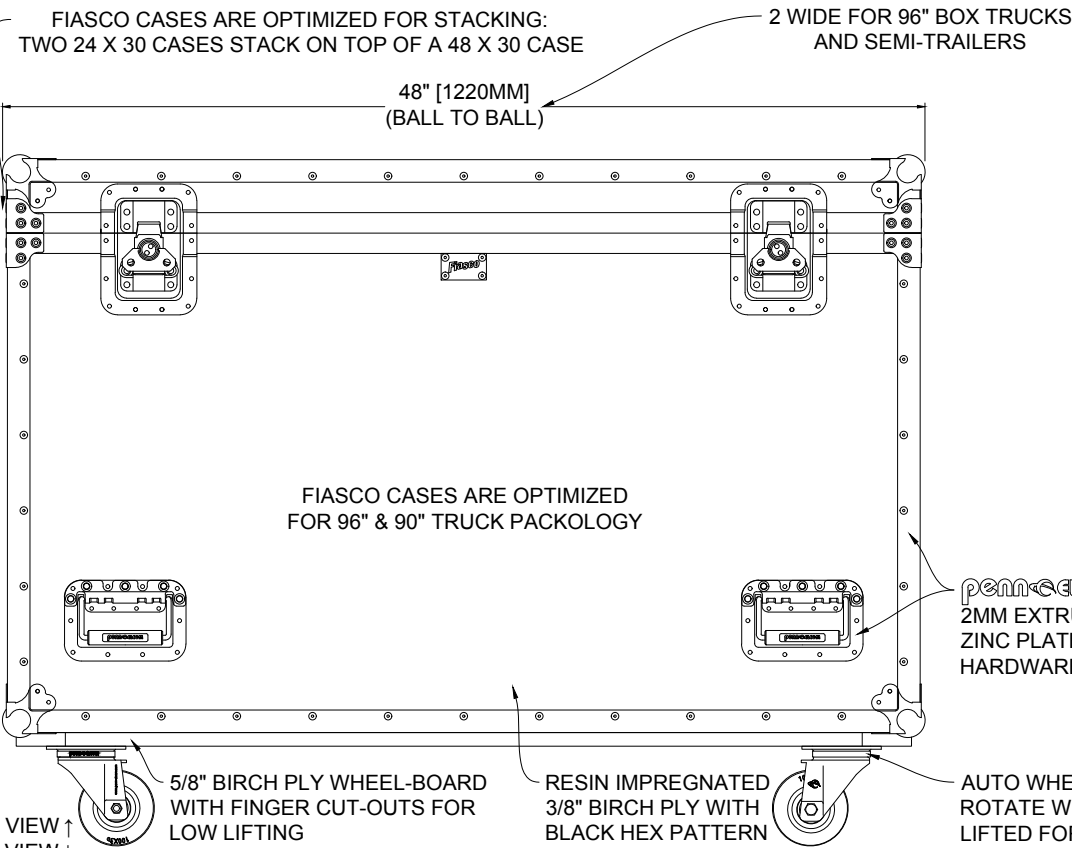
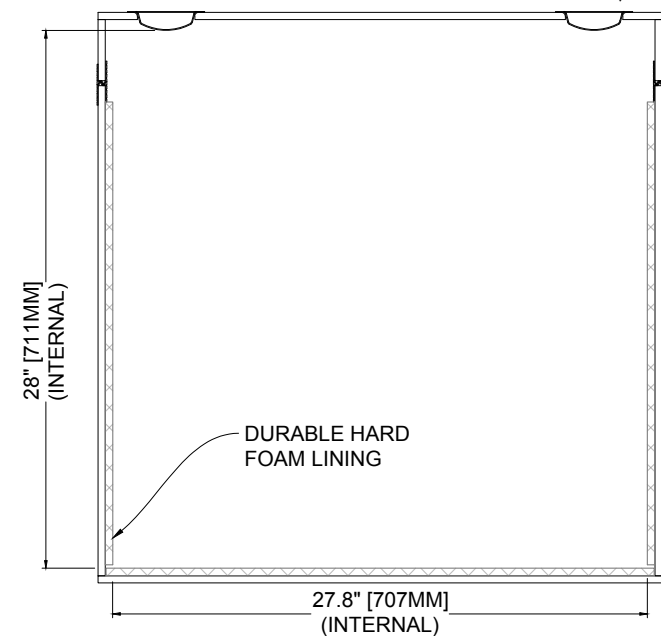
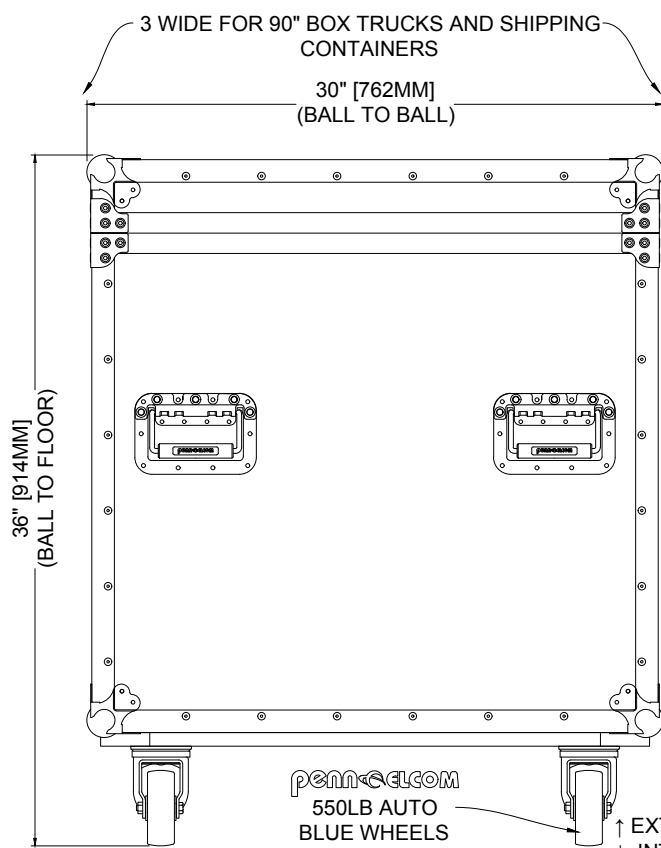

sales@fiascocases.com

// (323) 528-2430

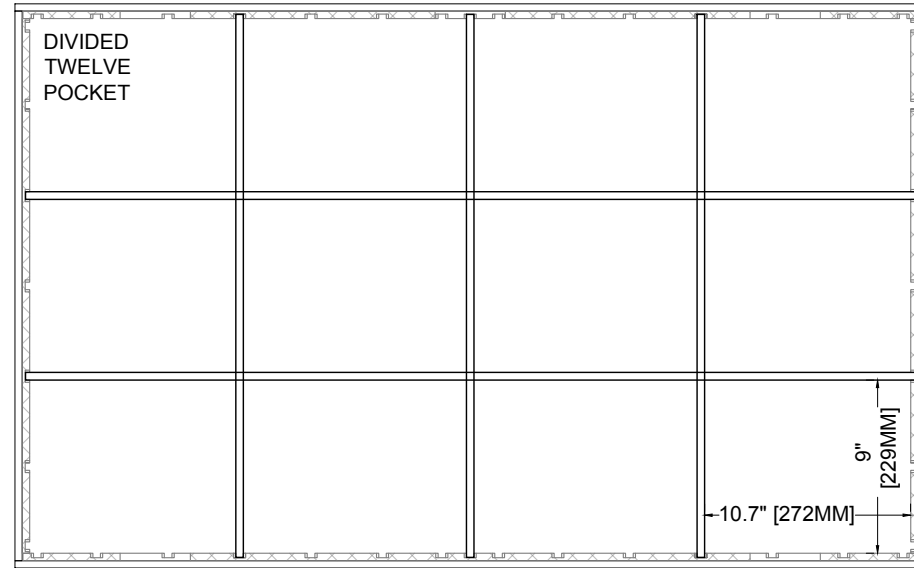
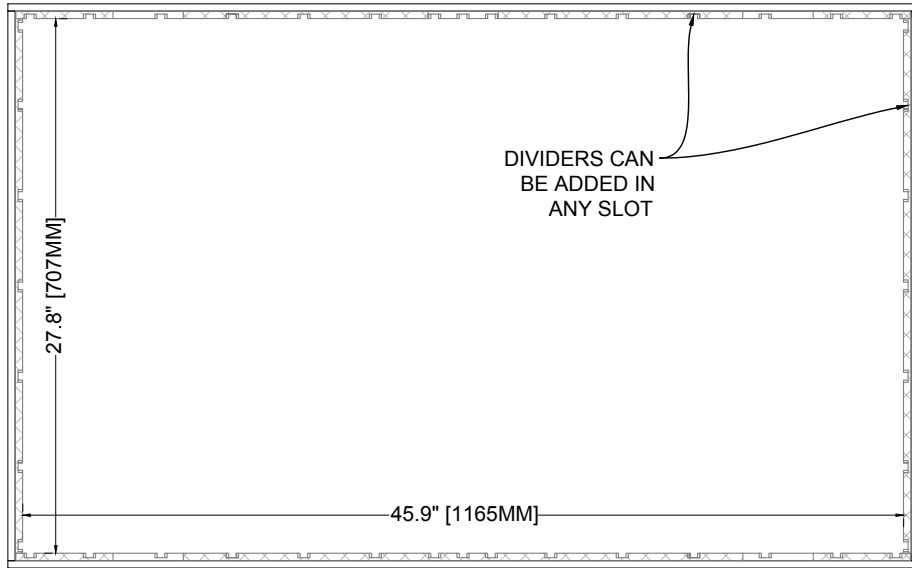

FIASCO BIRCH PLY INTERLOCK DIVIDERS:
 INTEGRATED SLOTS IN THE CASE ALLOW FOR UP TO:
 5 CROSSWAY DIVIDERS.
 5 LONGWAY DIVIDERS.

DIVIDERS CAN BE RAPIDLY CONFIGURED TO SUIT
 ANY APPLICATION.

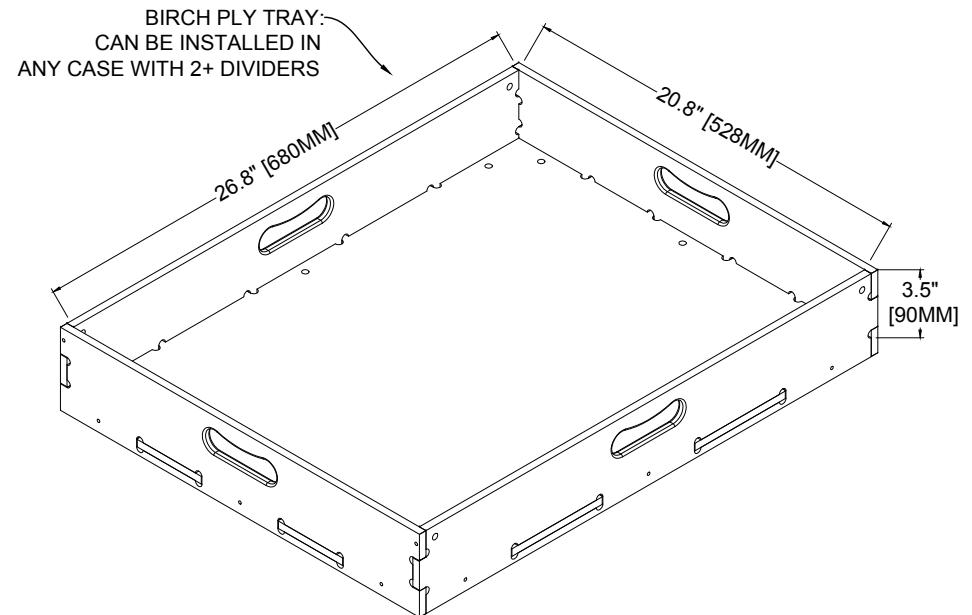
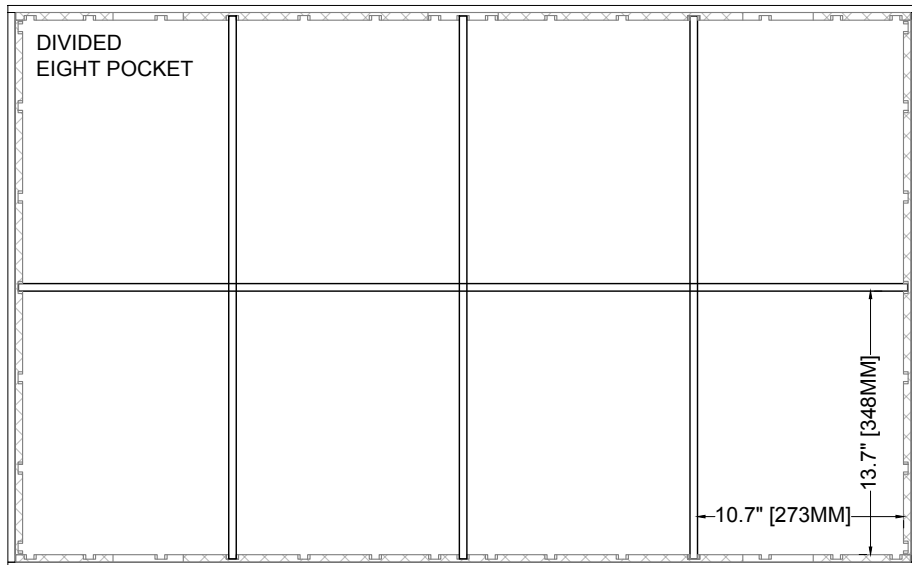

VERSION HISTORY	NOTES
#	DATE
5.00	23-AUG-18
	ORIGINAL

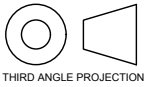

THIRD ANGLE PROJECTION

TITLE
48 X 30 TALL CASE

SHEET
FIASCO INTERLOCK DIVIDERS

FIASCOINTERLOCKDIVIDERS
 FIASCOCASES.COM

DATE
 23-AUG-18

DESIGNED
 MATT WATERHOUSE

PROJECT MANAGER
 JOE BRADFORD

SCALE | 1:10
 PAPER | A4
 FILE | 48 X 30 TALL CASE V5.00.dwg
 PLOT | 04/11/2019 12:18 PM
 SHEET | 2 OF 2

VERSION

