

FIASCO CASES ARE OPTIMIZED FOR 96" & 90" TRUCK PACKOLOGY:

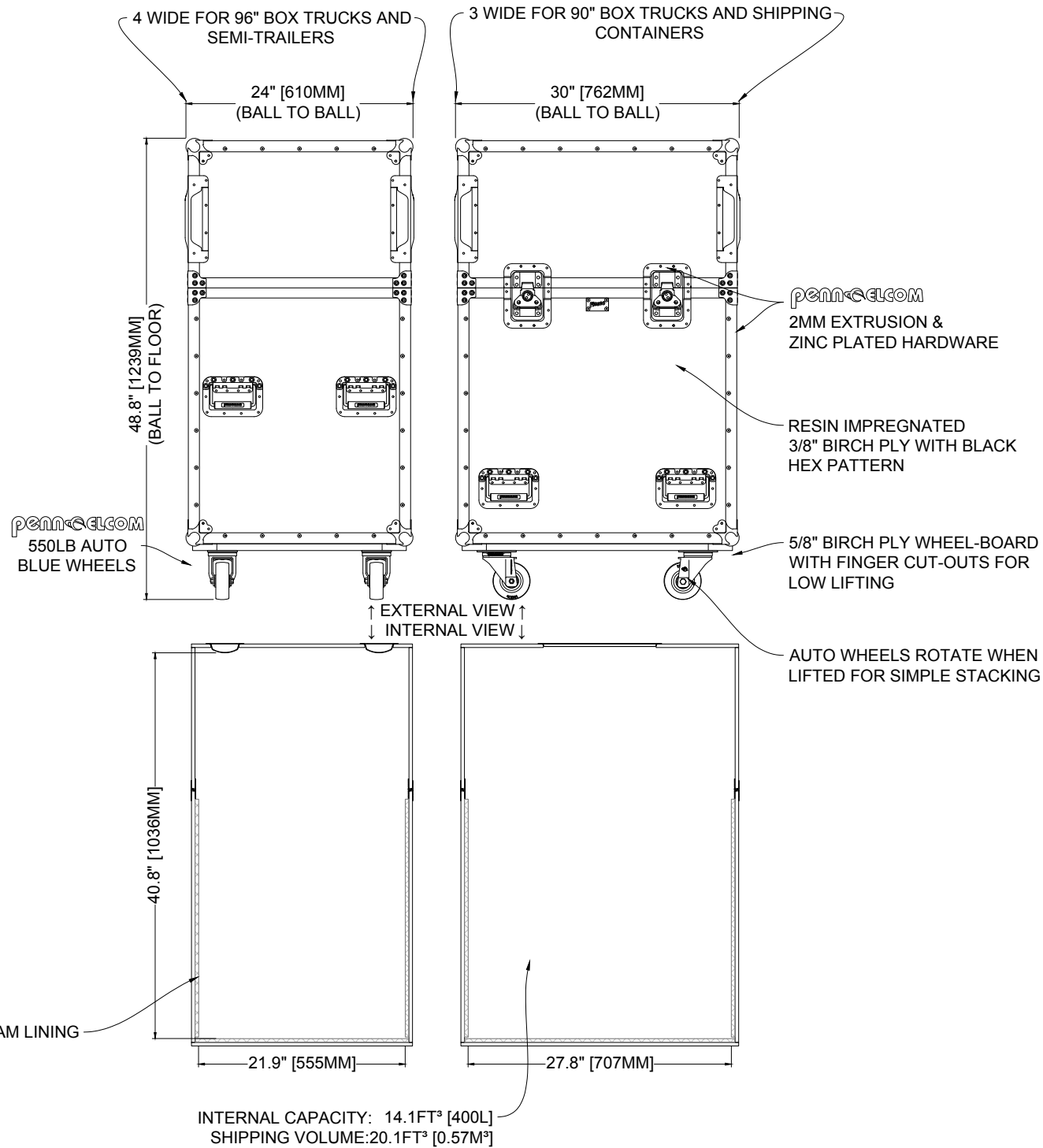

VERSION HISTORY	NOTES
#	DATE
5.00	12-JUL-19
	ORIGINAL

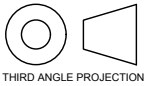

TITLE  
**24 X 30 MIC STAND CASE**

SHEET  
**OVERVIEW**

**FIASCOCASES.COM**

DATE  
12-JUL-19

DESIGNED  
ASH ALGIE

PROJECT MANAGER  
MATT WATERHOUSE

SCALE	1:10
PAPER	A4
FILE	24 X 30 MIC STAND CASE
PLOT	V5.00.dwg
SHEET	15/11/2019 03:50 PM
OF	

VERSION



VERSION HISTORY	
#	DATE
5.01	22-OCT-19
	NOTES
	ORIGINAL

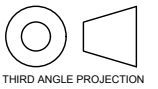

TITLE  
**24 X 30 INSERT MIC STAND**

SHEET  
**PAGE 1 OVERVIEW**

FIASCOCASES.COM

DATE  
22-OCT-19

DESIGNED  
ASH ALGIE

PROJECT MANAGER  
MATT WATERHOUSE

SCALE | 1:10  
PAPER | A4  
FILE | 24 X 30 INSERT MIC STANDS  
PLOT | V5.01.dwg  
SHEET | 15/11/2019 03:32 PM  
OF

VERSION

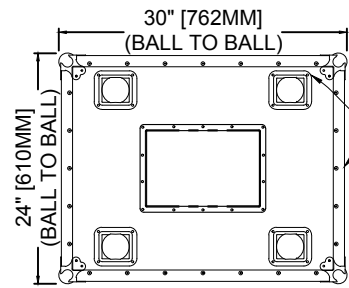

penn-alcom EXTRUSION &  
ZINC PLATED HARDWARE

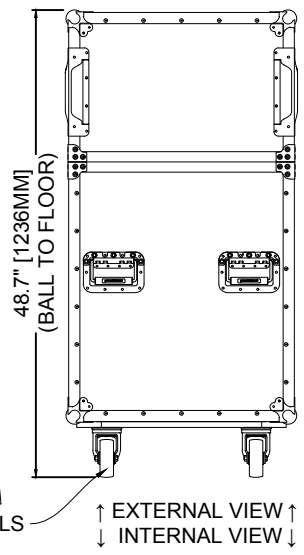

penn-alcom  
550LB BLUE WHEELS

↑ EXTERNAL VIEW ↑  
↓ INTERNAL VIEW ↓

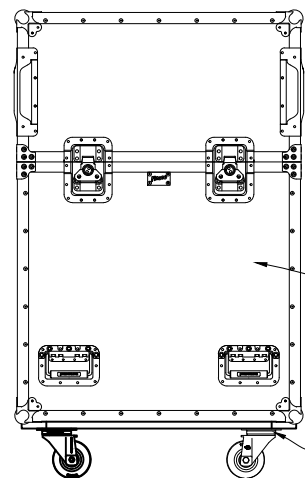

CHEMICAL RESISTANT RESIN  
IMPREGNATED 9MM PLY WITH  
BLACK HEX PATTERN

3/4" PLY WHEEL-BOARD WITH FINGER  
CUT-OUTS FOR LOW LIFTING

FIT 20x MIC STANDS IN DESIGNATED HOLES

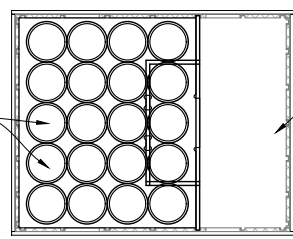

LARGE POCKET FOR EXTRAS

28.6" [727MM]  
(INTERNAL)

STORAGE BOX FOR MIC STAND BASES

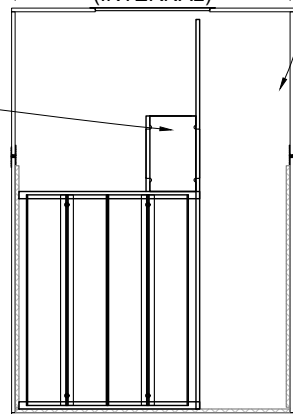
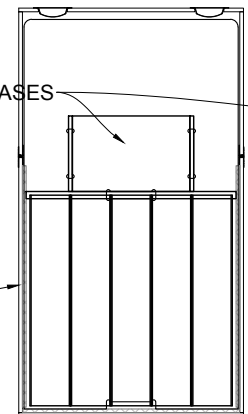

41.4" [1050MM]  
(INTERNAL)

SHIPPING VOLUME: 6.18FT<sup>2</sup>