

SG 1020

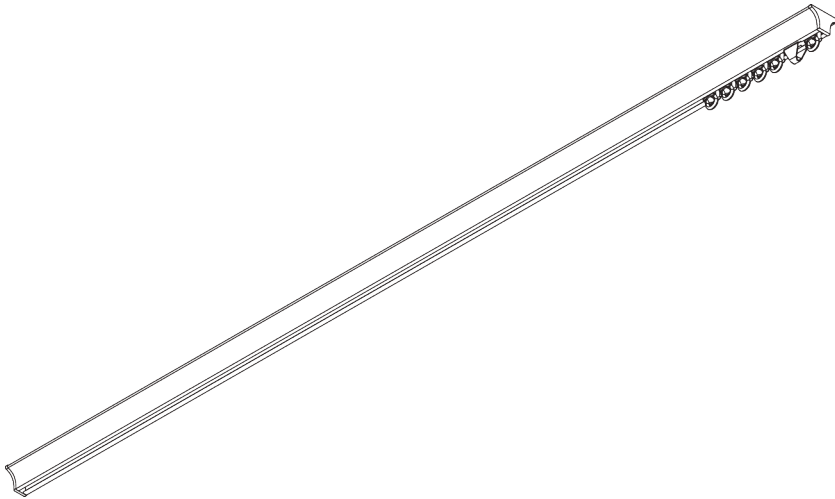

PRODUCT INFORMATION

- **Operation:** hand
- **Range:** S
- **Fitting:** ceiling
- **Colours:** white RAL 9016; special colours or anodised aluminum possible
- **Fabrics:** refer to Silent Gliss fabric collection

Features:

- Symmetrical funnel design
- Bendable

SYSTEM SPECIFICATIONS

A. SYSTEM DIMENSIONS

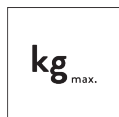

10 kg

B. PROFILE

Profile and bending information

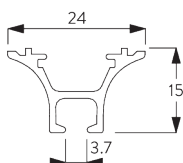

SG 6822

Profile Funnel



Radius:
>27 cm

C. HOW TO MEASURE

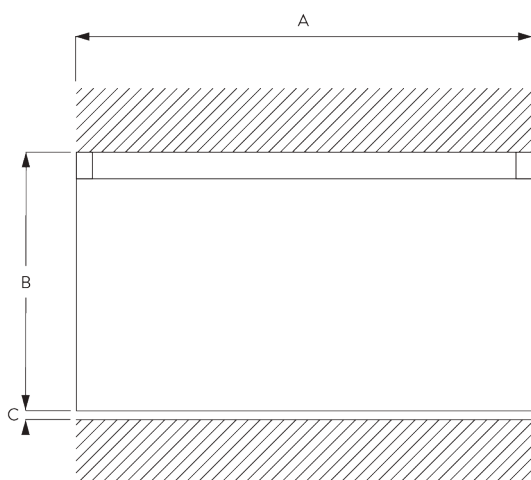

A: System width

B: System height

C: Distance between floor and fabric

D. SPECIFICATION TEXT

Silent Gliss SG 1020 Hand Operated Curtain Track System. Comprises aluminium profile SG 6822 supplied made to measure powder coated white, with gliders SG 3533 at 14/m and 2 end covers SG 6824 and 2 end stops SG 3016 per length. Top fixed with clip brackets SG 11236 at max. 500 mm centres.

FITTING

A. FITTING INFORMATION

For detailed fitting information, visit the *Silent Gliss* website.

Fixing points

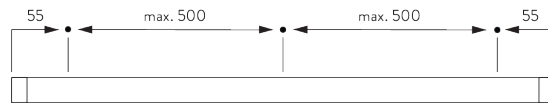

Fitting Tool

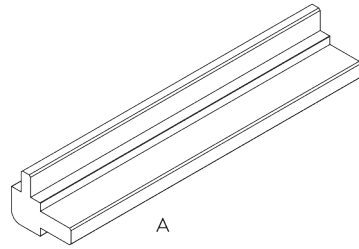

A: Funnel fitting tool SG 6827

For fitting / removing of the funnel profile.

B. CEILING FITTING

Clip SG 11236

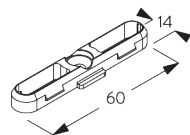
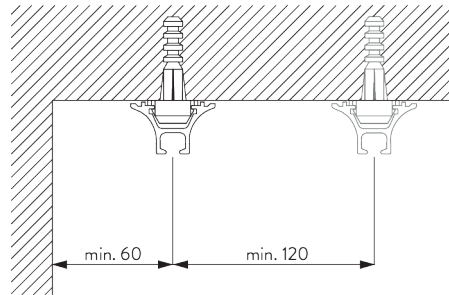





SG 11236



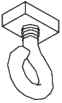



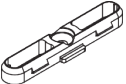



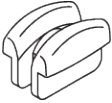

Clip

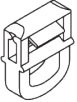
PARTS

A. STANDARD PARTS

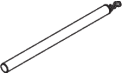
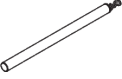
	SG 3016 End stop
	SG 3533 Glider
	SG 6822 Profile Funnel
	SG 6824 End cover
	SG 11236 Clip

B. OPTIONAL PARTS

	SG 3062 Connection bridge
	SG 3070 End stop
	SG 3071 End stop
	SG 3511 Glider
	SG 3534 Glider 3533 on strip
	SG 3548 Glider
	SG 3570 Glider
	SG 3582 Hook
	SG 3599 Hook
	SG 10430 Draw rod 50 cm
	SG 10431 Draw rod 75 cm
	SG 10432 Draw rod 100 cm
	SG 10433 Draw rod 125 cm
	SG 10434 Draw rod 150 cm

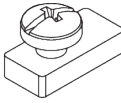
	SG 11335 End stop
---	-----------------------------