



TP-P-705

Vive Comfort

PO Box 3377
 Springfield, MO 65804
 Toll Free : 888-776-1427
 Web: www.vivecomfort.com
 Hours of Operation: M-F 9AM - 6PM Eastern

Thermostat Application Guide

Description	
Gas or Oil Heat	Yes
Electric Furnace	Yes
Heat Pump (No Aux. or Emergency Heat)	Yes
Heat Pump (With Aux. or Emergency Heat)	No
Multi-Stage Systems	No
Heat Only Systems	Yes
Heat Only Systems - Floor or Wall Furnace	Yes
Cool Only	Yes
Millivolt	Yes

Power Type

Battery Power
 Hardwire (Common Wire)
 Hardwire (Common Wire) with Battery Backup

A trained, experienced technician must install this product.

Carefully read these instructions. You could damage this product or cause a hazardous condition if you fail to follow these instructions.

Una version en espanol de este manual se puede descargar en la pagina web de la compania.

Table of Contents

Page

Installation Tips	2-3
Thermostat Quick Reference	4-5
Wiring	6
Wiring Diagrams	7-8
Features	9
About The Badge	10
Technician Setup	11-13
Programming Thermostat	13-16

Specifications

The display range of temperature ... 41°F to 95°F (5°C to 35°C)
 The control range of temperature.... 44°F to 90°F (7°C to 32°C)
 Swing (cycle rate or differential) Heating is adjustable from 0.2° to 2.0°
 Cooling is adjustable from 0.2° to 2.0°
 Power source 18 to 30 VAC, NEC Class II, 50/60 Hz for hardwire
 Battery power from 2 AA Alkaline batteries
 Operating ambient 32°F to +105°F (0°C to +41°C)
 Operating humidity 90% non-condensing maximum
 Dimensions of thermostat 4.7"W x 4.4"H x 0.8"D

1 © U.S. Registered Trademark. Patents pending
 Copyright © 2015 All Rights Reserved.

Rev. CH1612

Wall Locations

The thermostat should be installed approximately 4 to 5 feet above the floor. Select an area with average temperature and good air circulation.

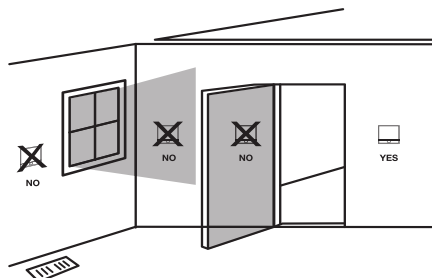

Do not install thermostat in locations:

- Close to hot or cold air ducts
- That are in direct sunlight
- With an outside wall behind the thermostat
- In areas that do not require conditioning
- Where there are dead spots or drafts (in corners or behind doors)
- Where there might be concealed chimneys or pipes



Installation Tip

Pick an installation location that is easy for the user to access. The temperature of the location should be representative of the building.

Subbase Installation

- 1 Horizontal Mount
- 2 Vertical Mount

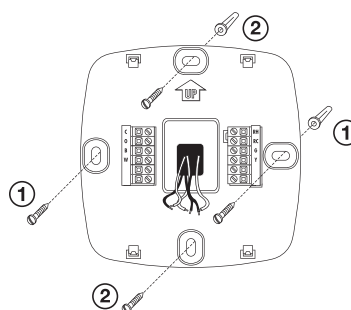

For vertical mount put one screw on the top and one screw on the bottom.
 For horizontal mount put one screw on the left and one screw on the right.



Installation Tip: Electrical Hazard

Failure to disconnect the power before beginning to install this product can cause electrical shock or equipment damage.



Mercury Notice

All of our products are mercury free. However, if the product you are replacing contains mercury, dispose of it properly. Your local waste management authority can give you instructions on recycling and proper disposal.

Installation Tips

Mount Thermostat

Align the 4 tabs on the subbase with corresponding slots on the back of the thermostat, then push gently until the thermostat snaps in place.



Battery Installation

Battery installation is recommended even if thermostat is hardwired (C terminal connected). When thermostat is hardwired and batteries are installed, the thermostat will activate a compressor delay of 5 minutes when the thermostat detects a power outage from the hardwired power supply.

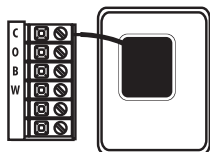

Important:

High quality alkaline batteries are recommended. Rechargeable batteries or low quality batteries do not guarantee a 1-year life span.

Insert 2 AA Alkaline batteries (included). High quality alkaline batteries are recommended.

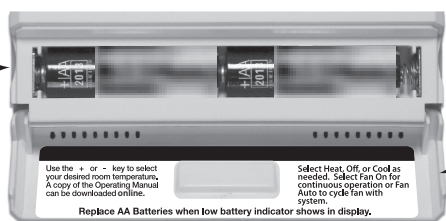

Simple operating instructions are found on the back of the battery door.

Thermostat Quick Reference

Getting to know your thermostat

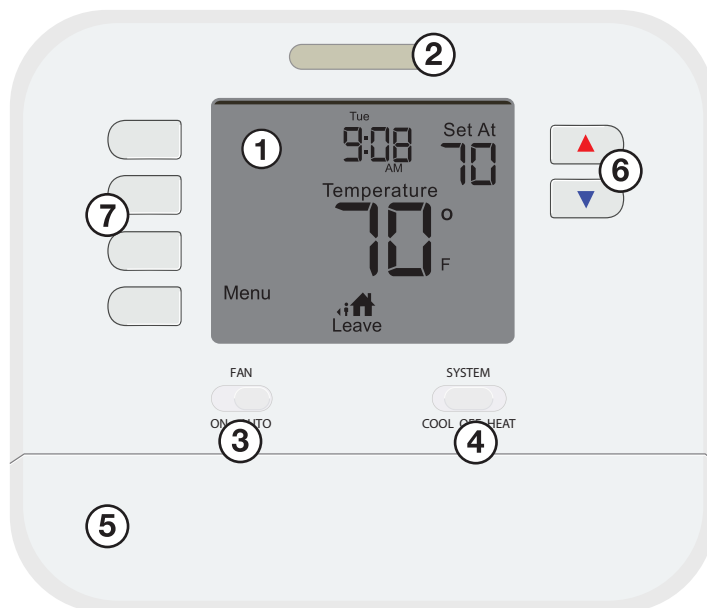

- 1 LCD Display
- 2 Glow in the dark light button
- 3 Fan Switch
- 4 System Switch
- 5 Easy change battery door
- 6 Temperature Setpoint Buttons
- 7 User Buttons

Getting to know your thermostat

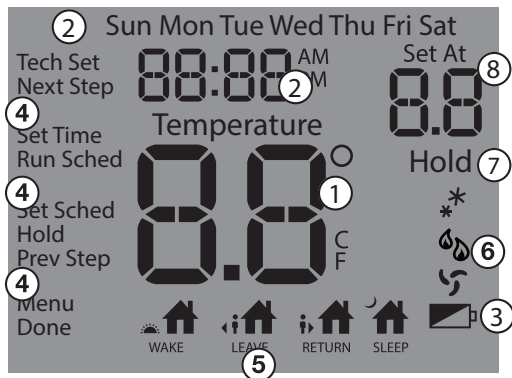

- ① Indicates the current room temperature
- ② Time and day of the week
- ③ **Low Battery Indicator:** Replace batteries when this indicator is shown.
- ④ **Button Options**
- ⑤ **Program Time Periods:** This thermostat has 4 programmable time periods per day.
- ⑥ **System Operation Indicators:**
The **COOL ON** *, **HEAT ON** 🔥 or **FAN** 🌀 icon will display when the **COOL**, **HEAT**, or **FAN** is on. **Note:** The compressor delay feature is active if these icons are flashing. The compressor will not turn on until the 5 minute delay has elapsed.
- ⑦ **Hold** is displayed when the thermostat program is permanently overridden.
- ⑧ **Setpoint:** Displays the user selectable setpoint temperature.

Important

The low battery indicator is displayed when the AA battery power is low. If the user fails to replace the battery within 21 days, the screen will only show the low battery indicator but maintain all functionality. If the user fails to replace the batteries after an additional 21 days (days 22-42 since first "low battery" display) the setpoints will change to 55°F (Heating) and 85°F (Cooling). If the user adjusts the setpoint away from either of these, it will hold for 4 hours then return to either 55°F or 85°F. After day 63 the batteries must be replaced immediately to avoid freezing or overheating because the thermostat will shut the unit off until the batteries are changed.

Wiring

1. If you are replacing a thermostat, make note of the terminal connections on the thermostat that is being replaced. In some cases the wiring connections will not be color coded. For example, the green wire may not be connected to the **G** terminal.
2. Loosen the terminal block screws. Insert wires then retighten terminal block screws.
3. Place nonflammable insulation into wall opening to prevent drafts.



Caution: Electrical Hazard

Failure to disconnect the power before beginning to install this product can cause electrical shock or equipment damage.



Warning:

All components of the control system and the thermostat installation must conform to Class II circuits per the NEC Code.

Terminal Designations

- C** Common wire from secondary side of cooling system transformer
- O** Heat pump changeover valve energized in cooling
- B** Heat pump changeover valve energized in heating
- W** Heat relay
- RH** Transformer power for heating
- RC** Transformer power for cooling
- G** Fan relay
- Y** Compressor relay

Wiring Tips

RH & RC Terminals

For single transformer systems, leave the jumper wire in place between RH and RC. Remove jumper wire for two transformer systems.

C Terminal

The C (common wire) terminal does not have to be connected when the thermostat is powered by batteries.

Heat Pump Systems (With NO AUX or Emergency Heat)

If wiring to a heat pump, use a small piece of wire (not supplied) to connect terminals W and Y.

Wire Specifications

Use shielded or non-shielded 18-22 gauge thermostat wire.



Installation Tip: Do not overtighten terminal block screws, as this can damage the terminal block. A damaged terminal block can keep the thermostat from fitting on the subbase correctly or cause system operation issues. **Max Torque = 6in-lbs.**

Features

Temporary and Permanent Hold Feature

When cool or heat is turned on, the thermostat will display **HOLD** and **RUN SCHED** on the left of your screen when you press the ▲ or ▼ button.

Temporary Hold: At this time if you do nothing, the temperature will remain at this setpoint temporarily until next time period.

Permanent Hold: If you press the **HOLD** key on the left of your screen, you will see **HOLD** appear below the setpoint temperature in the display. The thermostat will now permanently stay at this setpoint and can be adjusted using the ▲ or ▼ keys.

To Return to Running Schedule: Press the **RUN SCHED** button on the left of your screen to exit either temporary or permanent hold.

Filter Change Reminder

If your installing contractor has configured the thermostat to remind you when the air filter needs to be changed, you will see **FILT** in the display when your air filter needs to be changed.

Resetting the filter change reminder: When **FILT** reminder is displayed, you should change your air filter and reset the reminder by holding down the second button from the top left side of the thermostat for 3 seconds.

Hold down 3 seconds, to reset filter reminder.

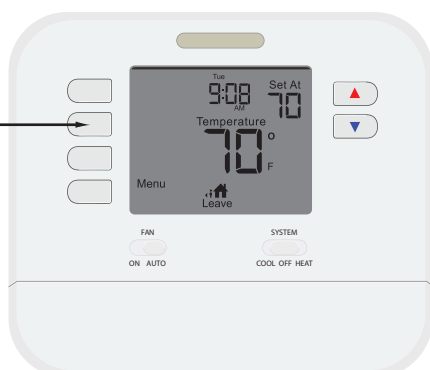

Private Label Badge

About The Badge

All of our thermostats use the same universal magnetic badge. Visit the company website to learn more about our free private label program.

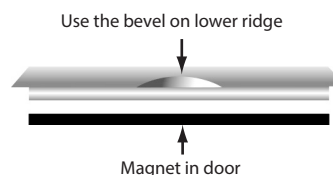
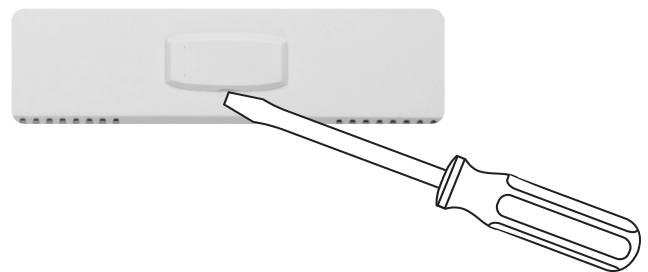

Gently slide a screwdriver into the bottom edge of the badge. Gently turn the screwdriver counter clockwise. The badge is held on by a magnet in the well of the battery door. The badge should pry off easily. **DO NOT USE FORCE.**

Wiring Diagrams

- 1 Power supply
- 2 Factory-installed jumper. Remove only when installing on 2-transformer systems
- 3 Use either O or B terminals for changeover valve
- 4 Use a small piece of wire (not supplied) to connect W and Y terminals
- 5 Set fan operation setting to Electric
- 6 Optional 24 VAC common connection when thermostat is used in battery power mode

Typical 1H/1C System: 1 Transformer

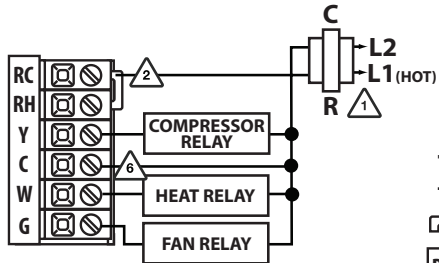

Typical 1H/1C System: 2 Transformer

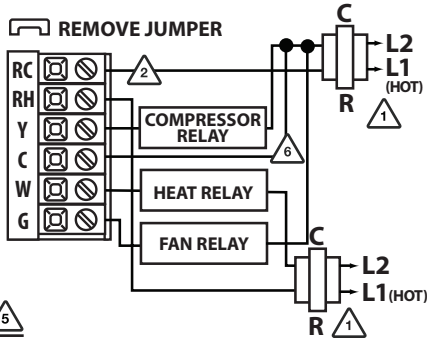

Typical 1H/1C Heat Pump System

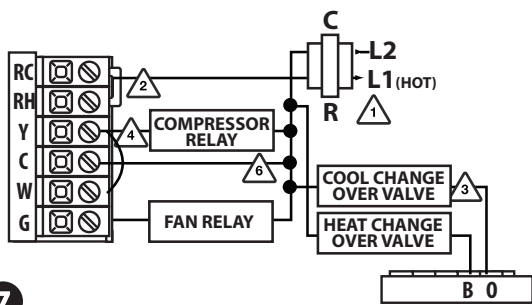

Wiring Diagrams

- 1 Power supply
- 2 Factory-installed jumper. Remove only when installing on 2-transformer systems
- 3 Use either O or B terminals for changeover valve
- 4 Use a small piece of wire (not supplied) to connect W and Y terminals
- 5 Set fan operation setting to Electric
- 6 Optional 24 VAC common connection when thermostat is used in battery power mode

Typical Heat-Only System

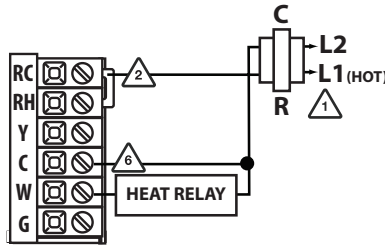

Typical Heat Only System With Fan

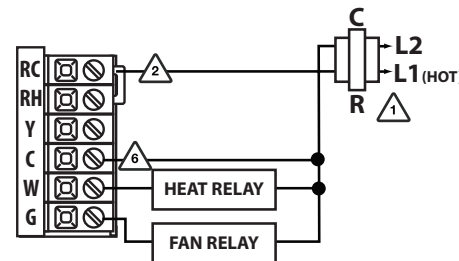

Typical Cool-Only System

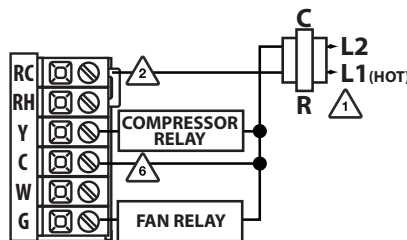

7

8

Tech Settings

Technician Setup Menu

This thermostat has a technician setup menu for easy installer configuration. To setup the thermostat for your particular application:

1. Press the **MENU** button
2. Press and hold **TECH SET** button for 3 seconds. This 3 second delay is designed so that homeowners do not accidentally access the installer settings.
3. Configure the installer options as desired using the table below.

Use the ▲ or ▼ keys to change settings and the **NEXT STEP** or **PREV STEP** key to move from one step to another. **Note:** Only press the **DONE** key when you want to exit the Technician Setup options.

Tech Settings	LCD Will Show	Adjustment Options	Default
Filter Change Reminder	100 SE Next Step: FI Prev Step: SE	You can adjust the filter change reminder from OFF to 2000 hours of runtime in 50 hour increments. Tap the second button from the top left side of the thermostat to display the current filter elapsed runtime.	OFF
Room Temperature Calibration	CAL Next Step: 0 Prev Step: CAL	You can adjust the room temperature display to read 4° above or below the factory calibrated reading.	0
Compressor Short Cycle Delay	CD Next Step: 07 Prev Step: CD	Selecting "ON" will not allow the compressor to be turned on for 5 minutes after the last time the compressor was switched off. Select "OFF" to remove this delay.	ON
Minimum Compressor On Time	OFF Next Step: 07 Prev Step: 00	You can select the minimum compressor run time from "off", "3", "4", or "5" minutes. If 3, 4, or 5 is selected the compressor will run for at least the selected time before turning off.	OFF

Tech Settings

Tech Settings	LCD Will Show	Adjustment Options	Default
Cooling Swing	dfCO Next Step: 05 Prev Step: dfCO	The swing setting often called "cycle rate", "differential" or "anticipation" is adjustable. A smaller swing setting will cause more frequent cycles and a larger swing setting will cause fewer cycles.	0.5
Heating Swing	dfHE Next Step: 04 Prev Step: dfHE	The swing setting often called "cycle rate", "differential" or "anticipation" is adjustable. A smaller swing setting will cause more frequent cycles and a larger swing setting will cause fewer cycles.	0.4

Swing Setting Tip

Temperature swing, sometimes called differential or cycle rate, can be customized for this individual application. For most applications choose a swing setting that is as long as possible without making the occupants uncomfortable.

11

12

Set Time

1. With system switch set to OFF, press the **MENU** button
2. Press **SET TIME**
3. Day of the week will be flashing. Use the ▲ or ▼ key to select the current day of the week.
4. Press **NEXT STEP**
5. The current hour is flashing. Use the ▲ or ▼ key to select the current hour. When using 12-hour time, make sure the correct a.m. or p.m. choice is selected.
6. Press **NEXT STEP**
7. Minutes are now flashing. Use the ▲ or ▼ key to select current minutes.
8. Press **DONE** when completed.

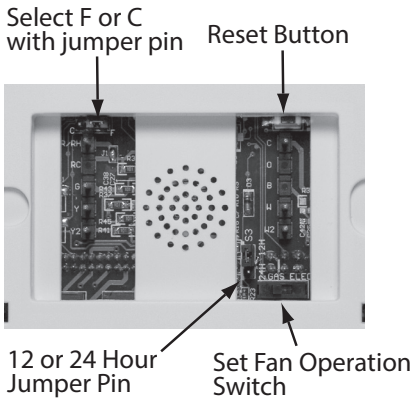

Gas or Electric Setup

Gas: For systems that control the fan during a call for heat, put the fan operation switch to the **GAS** position.

Electric: With the operation switch in the **ELEC** position, and the fan relay connected to the **G** terminal. The thermostat will control the fan during a call for heat.

Fahrenheit/Celsius Display

Select **F** or **C** with the jumper pin on the back of the thermostat. **F** is for Fahrenheit and **C** is for Celsius.

12 or 24 Hour Time

12 or 24 hour (military time) can be selected with the jumper pin.

Warning:

The RESET button must be pressed after changing any switch or jumper pin setting. Batteries must be installed for this operation.

Programming

All of our programmable thermostats are shipped with an energy saving pre-program. You can customize this default program by following the steps on page 16.

Your thermostat can be programmed to have all the weekdays the same, a separate program for Saturday, and a separate program for Sunday. There are four time periods for each program (**WAKE, LEAVE, RETURN, SLEEP**).

Factory Default Program				
Day of the Week	Events	Time	Setpoint Temperature (HEAT)	Setpoint Temperature (COOL)
Weekday	Wake	6 AM	70°F (21°C)	75°F (24°C)
	Leave	8 AM	62°F (17°C)	83°F (28°C)
	Return	6 PM	70°F (21°C)	75°F (24°C)
	Sleep	10 PM	62°F (17°C)	78°F (26°C)
Saturday	Wake	6 AM	70°F (21°C)	75°F (24°C)
	Leave	8 AM	62°F (17°C)	83°F (28°C)
	Return	6 PM	70°F (21°C)	75°F (24°C)
	Sleep	10 PM	62°F (17°C)	78°F (26°C)
Sunday	Wake	6 AM	70°F (21°C)	75°F (24°C)
	Leave	8 AM	62°F (17°C)	83°F (28°C)
	Return	6 PM	70°F (21°C)	75°F (24°C)
	Sleep	10 PM	62°F (17°C)	78°F (26°C)

Programming

You can use the table below to plan your customized program schedule.

Custom Program				
Day of the Week	Events	Time	Setpoint Temperature (HEAT)	Setpoint Temperature (COOL)
Weekday	Wake			
	Leave			
	Return			
	Sleep			
Saturday	Wake			
	Leave			
	Return			
	Sleep			
Sunday	Wake			
	Leave			
	Return			
	Sleep			

Programming

Set Program Schedule

To customize your program schedule, follow these steps

Weekday:

1. Select **HEAT** or **COOL** with the system switch. **Note:** You have to program heat and cool each separately.
2. Press the **MENU** button (If menu does not appear first press **RUN SCHED**)
3. Press **SET SCHED**. Note: Monday-Friday is displayed and the **WAKE** icon is shown. You are now programming the wake time period for the weekday setting.
4. Time is flashing. Use the ▲ or ▼ key to make your time selection for the weekday **WAKE** time period.
5. Press **NEXT STEP**
6. The setpoint temperature is flashing. Use the ▲ or ▼ key to make your setpoint selection for the weekday wake period.
7. Press **NEXT STEP**
8. Repeat steps 4 thru 7 for weekday **LEAVE** time period, for weekday **RETURN** time period, and for weekday **SLEEP** time period.

Saturday:

Repeat steps 4 thru 7 for the Saturday **WAKE** time period, for the Saturday **LEAVE** time period, for the Saturday **RETURN** time period, and for the Saturday **SLEEP** time period.

Sunday:

Repeat steps 4 thru 7 for the Sunday **WAKE** time period, for the Sunday **LEAVE** time period, for the Sunday **RETURN** time period, and for the Sunday **SLEEP** time period.