

BACKFIRE

G2 BLACK-2020

User Guide



WARNING



RISK OF DEATH OR SERIOUS INJURY

Whenever you ride a board, you risk death or serious injury from loss of control, collision, and falls. To ride safely, you must read and follow the instructions and warnings in the manual.

Always wear a helmet when riding. Avoid water, wet surfaces, slippery / uneven surfaces, steep hills, traffic, cracks, tracks, gravel, rocks, or any obstacles that could cause a loss of traction and cause a fall. Avoid night riding, areas with poor visibility, and small spaces.

Warning: Do not ride on side-hills or on an incline of more than 10 degrees. Do not ride at speed which you would not safely control the board. In case of wireless interface or battery error, you may need to rely on skating techniques like foot braking or sliding to stop.



WARNING: AVOID WATER!

Your board is not waterproof, it is water resistant only.
Water damage is not covered under warranty.



WARNING: PINCH POINTS!

Keep fingers, hair, and clothing away from belts, motors, wheels, and all moving parts.



WARNING: RISK OF ELECTRONIC SHOCK!

Do not open or tamper with electronics housing, which also voids the warranty.

INTRODUCTION

Thank you for purchasing this board.
It is a portable and eco-friendly transport unit with incredible fun.

The lightweight design and compact dimensions make it
a perfect city last mile vehicle.

It allows you to travel up to 12.5mi / 20 km,
with an exciting **24** mph / **38** kmh top speed.

Equipped with advanced braking system,
it brings the safety of riders and other people.

Enjoy your ride !

PROTECT

- **ALWAYS WEAR A HELMET**
- Find an open, flat area with clean pavement for your first ride.
- Read the warning on the skateboard and at the beginning of this manual.
- **OTHER PROTECTIVE EQUIPMENT IS HIGHLY RECOMMENDED.**

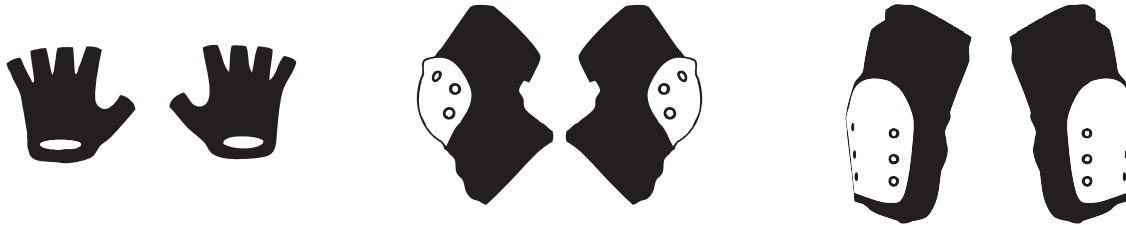

STANCE

Follow these tips to ensure a safe riding experience:

- Move the Throttle Wheel in small increments.
- Keep a wide stance on the board.
- Keep a low center of gravity.
- Lean forward when accelerating.
- Lean backward when braking.

FEATURES



Two riding modes:

Sports mode with top speed **24 mph / 38 kmh**

Economic mode with top speed **12.4 mph / 20 kmh**



20% uphill capability:

Actual performance depends on rider's weight and road condition.



Quick charge:

Board charging time **3.5 hrs**

Remote charging time **30 mins**



Light weight construction:

Board net weight **16.5lbs / 7.5kg.**

Thinnest point at **0.5 inch / 1.2 cm**

SPECIFICATION

BOARD

Deck Material: Canadian Maple
Deck Dimensions: 970mm x 230mm
Wheel Material: PU
Wheel Size: 96mm
Battery Type: Li-ion
Battery Cell Quantity: 20 pcs
Battery Charging Time: 3.5 hours
Motor Type: Brushless Direct Current
Transmission Model: In-wheel motor driving system
Board Weight: 16.5lbs / 7.5kg

REMOTE

Material: ABS Plastic
Weight: 60g
Battery Type: Lithium
Wireless Connection: 2.4GHz
Charging Voltage: 5V
Battery Charging Time: 30 minutes

PERFORMANCE

Max. User Weight: 120kg / 265 lbs
Max. Range: 12.5miles / 20km
Sports Mode Max.: 24 mph / 38kmh
Economic Mode Max.: 12.4 mph / 20kmh

CHARGER

Input: AC 100-240V / 50-60HZ / 3.0A Max.
Output: 42V / 2.5A
Charge Indicator: Red when charging /
Green when charged

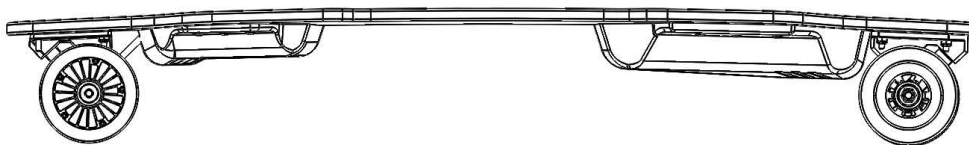

BOARD GLOSSARY

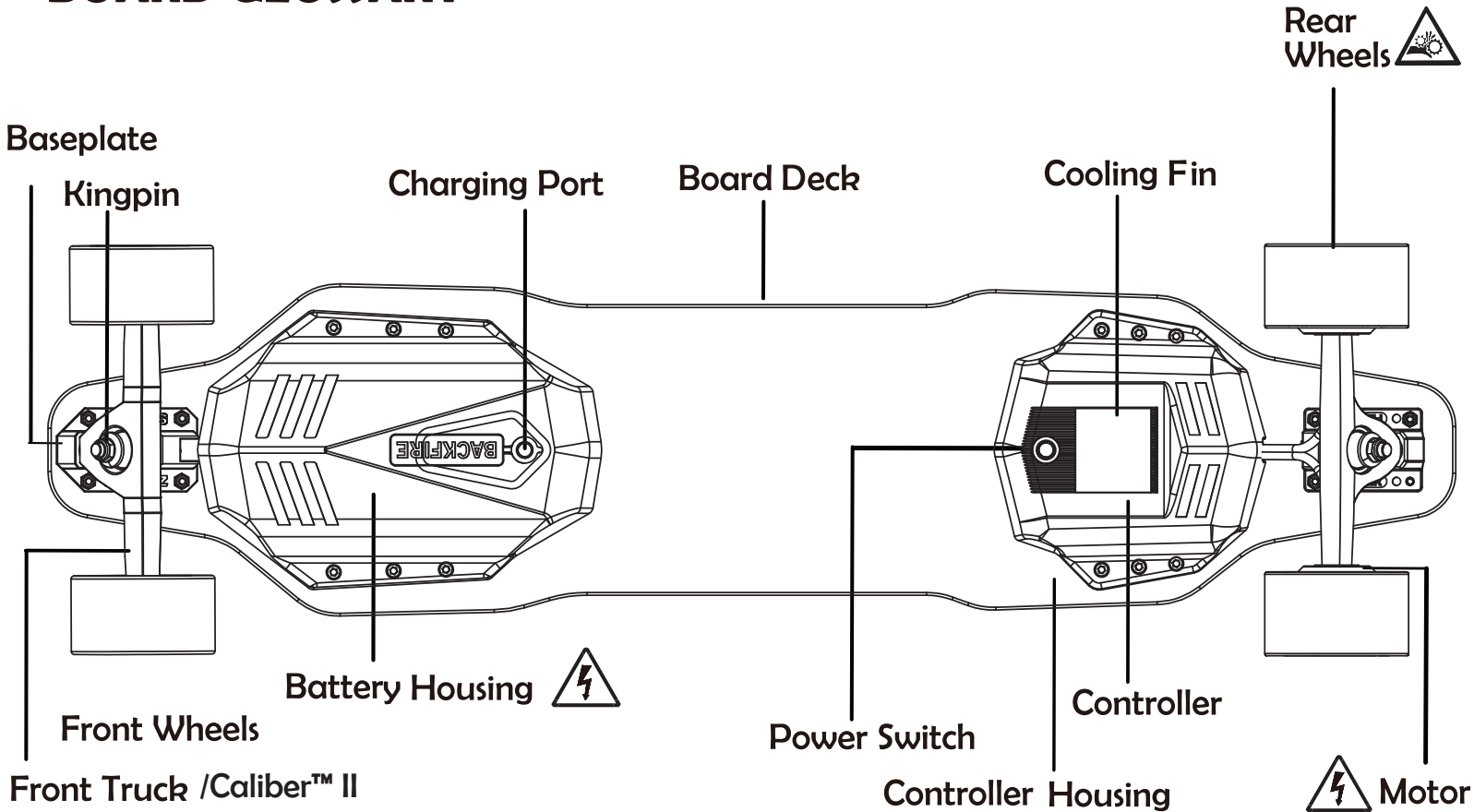

DRIVING PARTS GLOSSARY

NOTE: Below illustration shows how you can replace rear tires.

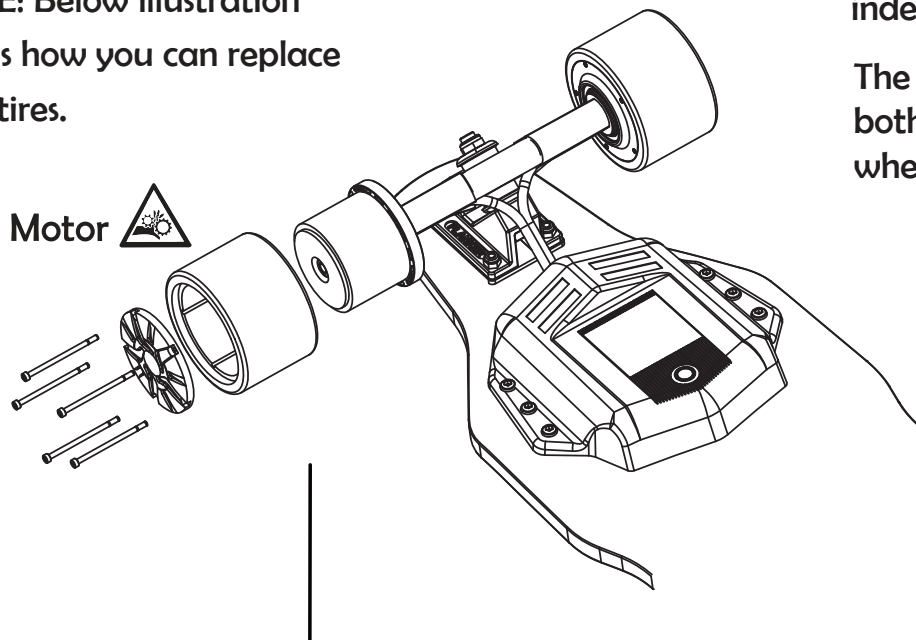

The motor and the tires are independently replaceable.

The motor is compatible with both 85mm wheels and 96mm wheels.

275mm wide wheel span provides extra stability at high speed riding

REMOTE GLOSSARY

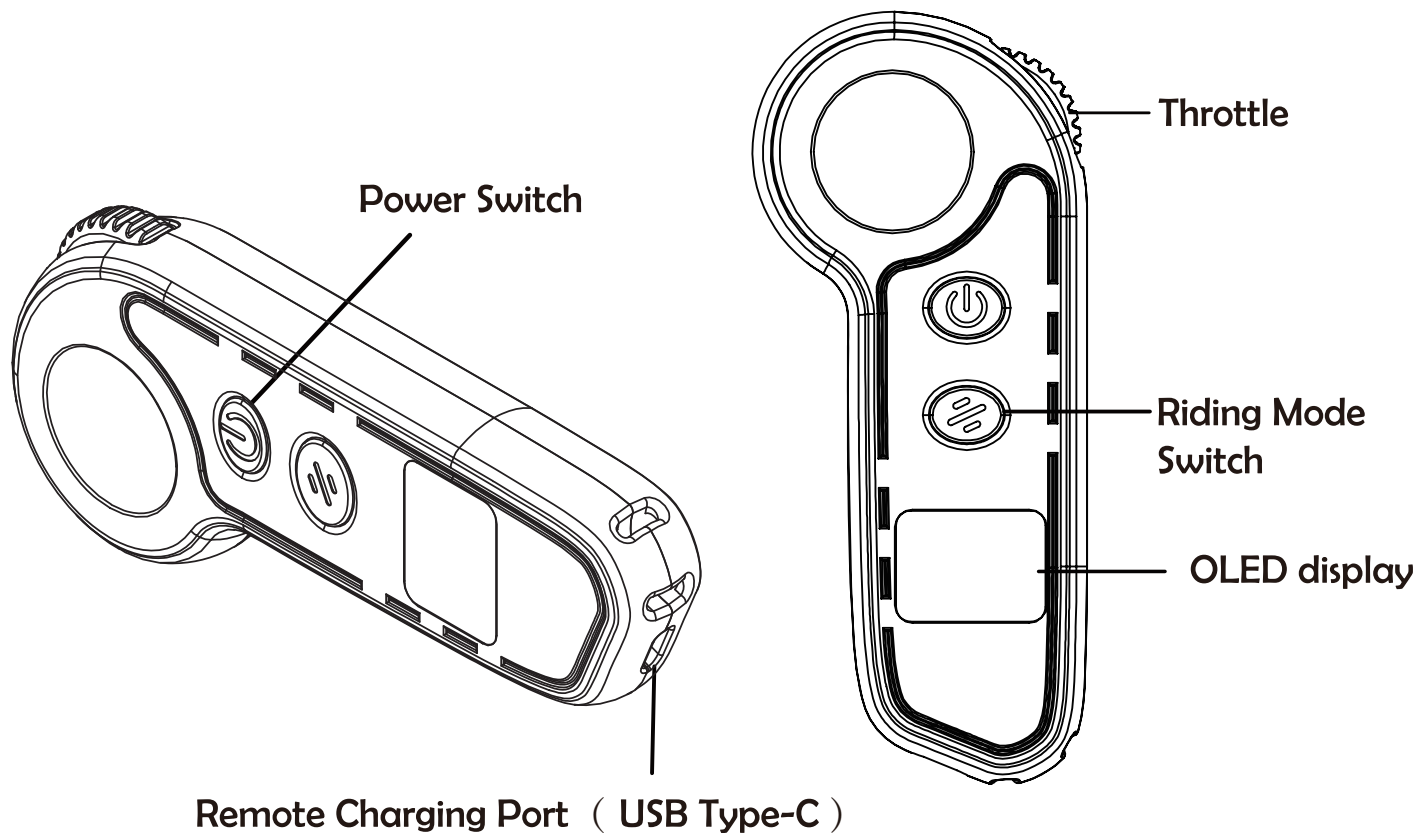

POWER ON/OFF THE REMOTE AND BOARD

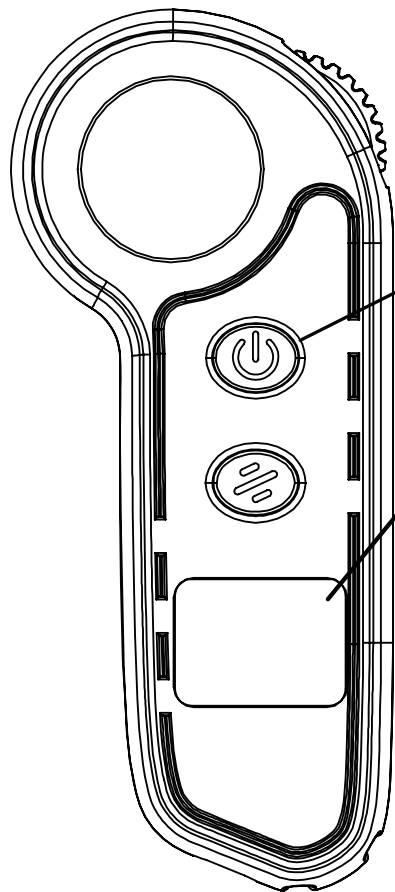

Press power switch
for **1** second

Oled display

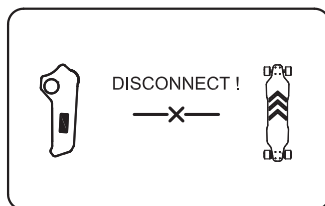

The board is not turned on,
or not paired with the remote;

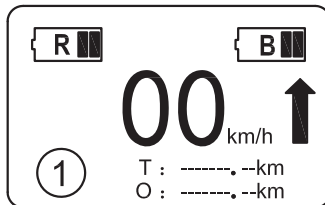

Press the power switch of the board,
the board indicator will be turned
on, and the remote will show speed,
battery, mode and other information

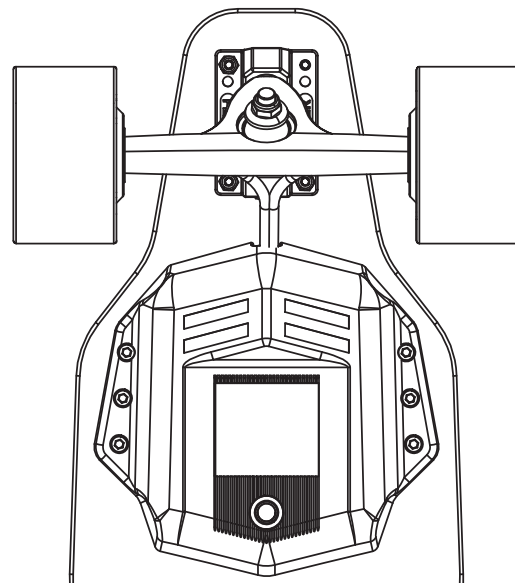

CHECK THE REMOTE / BATTERY LIFE

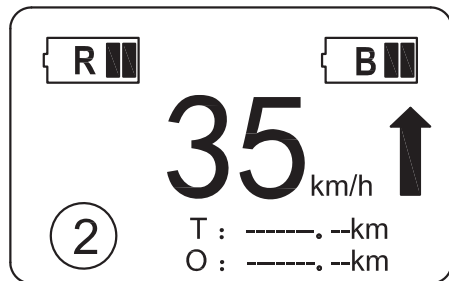
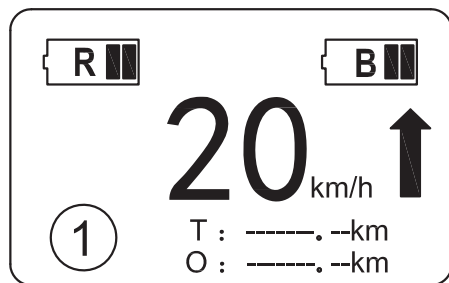
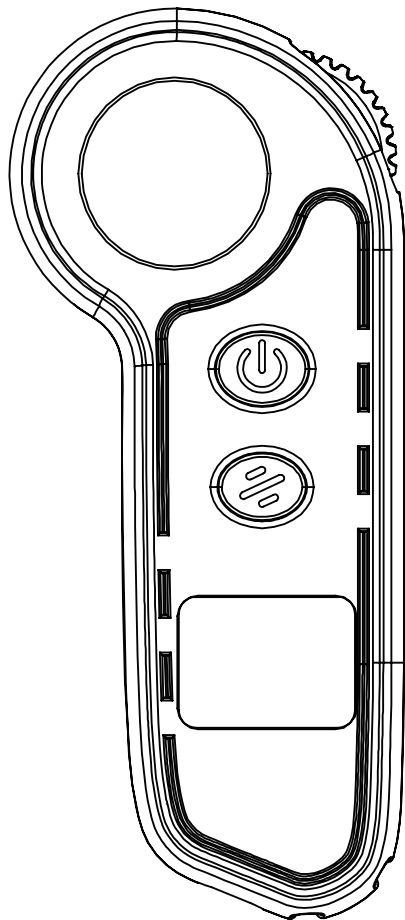

20 Current speed in
ECONOMIC mode /
35 SPORTS mode

 Remaining capacity of
the remote battery

 Remaining capacity of
the board battery

① Economic Mode

② Sports Mode



↑ Forward

↓ Backward

T : DST TRIP DISTANCE

O : Odometer

Economic mode

Press  , it will enter the economic mode, remote will show 



In economic mode, the top speed is 12.4mph / 20km/h

Forward / Backward

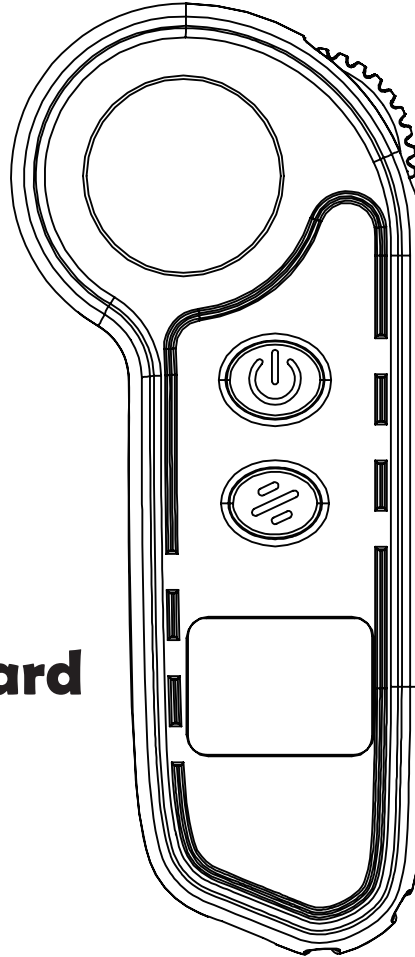
Double-click the  button to switch the forward mode or backward mode



Sports mode

Press  , it will enter the sports mode, remote will show 

In sports mode, the top speed is 24mph / 38km/h

Connecting & Binding

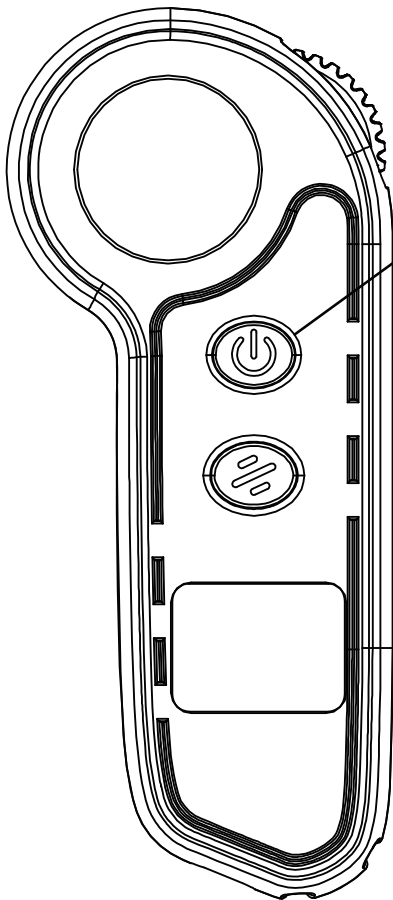

Press power switch for 5 seconds

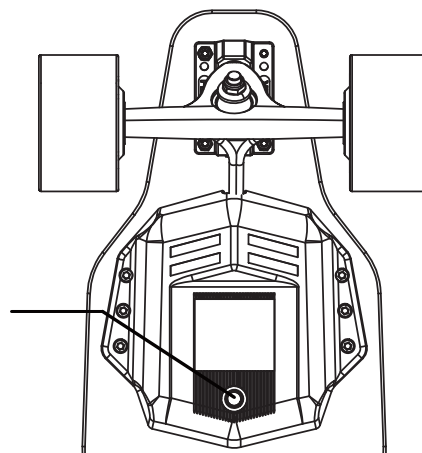

1. Press the power switch of the remote and the board at the same time, and hold it for 5 seconds.

2. The remote enters the settings interface.

3. Press  to switch between "km/h" and "phm/mile", then press  to select.

4. Continue to press  to switch between "105" "85" "96" and "165", then press  to select.(It depends on the diameter of the wheels)

5. When the remote displays information such as battery, speed, mode and range, that means the binding succeed.

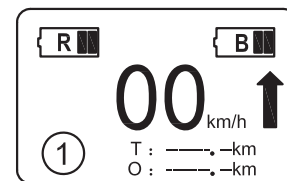
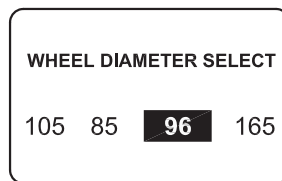
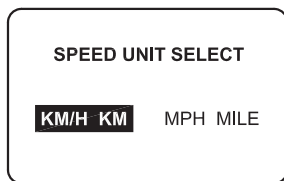

OPERATE THE BOARD WITH THE REMOTE

Push the throttle forward to accelerate.

Move the Throttle Wheel in small increments.

Keep a wide stance on the board.

Keep a low center of gravity.

Lean forward when accelerating.

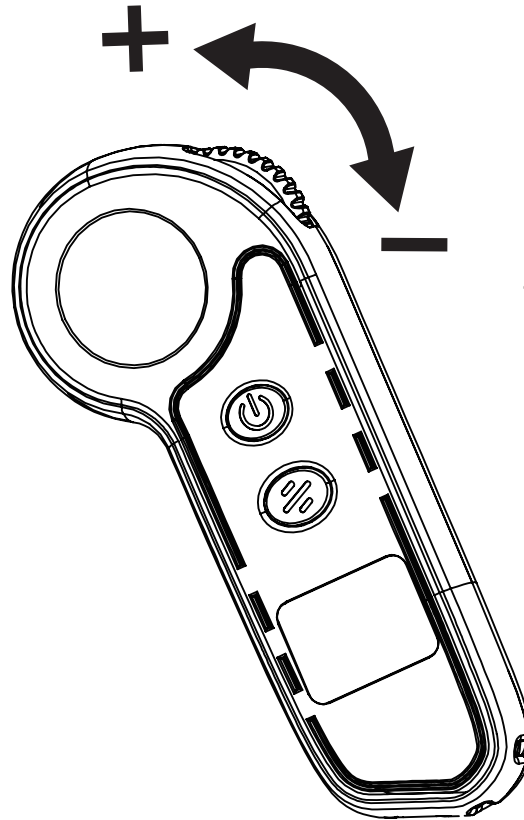
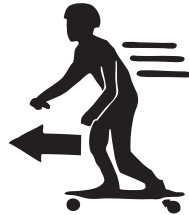

Pull the throttle backward to brake.

Move the Throttle Wheel in small increments.

Keep a wide stance on the board.

Keep a low center of gravity.

Lean backward when braking.

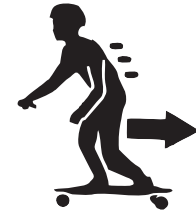

CHARGE THE REMOTE / BOARD

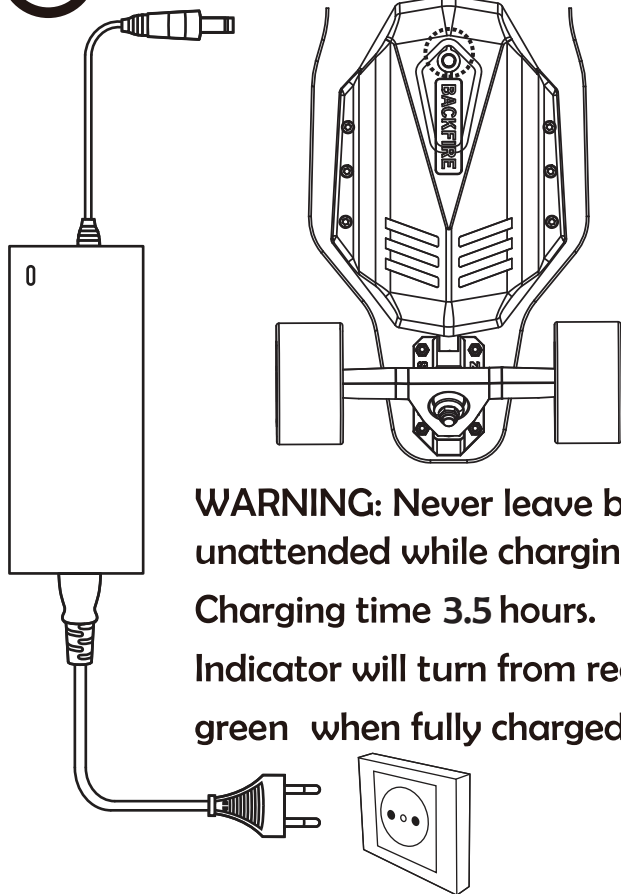

WARNING: Never leave board unattended while charging.

Charging time 3.5 hours.

Indicator will turn from red to green when fully charged.

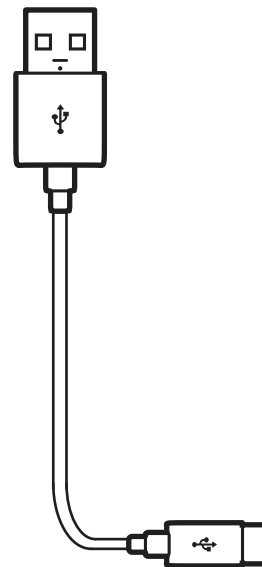

Remote charge time 30 minutes.

Indicator will turn from red to green when fully charged.

RIDING OUTSIDE OF YOUR PRIVATE PROPERTY

Abide by the laws and regulations in your state or country.

Respect other drivers and pedestrians on the road.

Avoid riding in busy traffics and crowded areas.

Do not park your board in a way that blocks people or traffic, or may create a safety issue.

Cross road at designated crosswalks or signaled intersections.

When riding with other riders, keep a safe distance from each other and other transport devices.

Identify and keep a safe distance from hazards and obstacles on the road.

Do not ride your board on private property unless you have obtained permission.

STORAGE AND MAINTAINANCE

Do frequent maintainance checks, make sure all screws are tight before riding.

Clean the bearings regularly.

Turn off board and controller when not in use.

Recharge the battery in well ventilated area.

Do not charge the battery in area with might wet the board or charging units.

Do not leave the board charging unattended.

Stop using the product or charging unit if any wire is damaged.

Only use charging units supplied by us.

Do not use the board battery to power any other equipments.

BATTERY SAFETY

Lithium-ion battery can explode or cause a fire if they are used incorrectly. Therefore, it is recommended to read the following instructions very carefully:

- Each time before riding the board, carefully check the battery pack and especially the protective seal. Make it is undamaged and intact. If in doubt, take the battery to a chemical waste disposal facility.
- Never drop the board.
- Store the board with battery inside in a dry place.
- Never expose the battery to temperature above 100 celsius degrees.
- Only use official board charger for charging board battery.
- Never leave the board unattended when charging.
- Never make the board work when charging.
- If you are not planning to use the board for about **2** months or longer, **Charge to 50%-60% and charge it once a month. A lithium-ion battery that has been left empty for too long no longer be charged.**
- Charge fully the battery before first time use. This gives it better long-term performance.



WARRANTY

LIMITED WARRANTY:

- We offer 6 months (180 days) warranty on parts from the date when you receive the board.
 - If a defect arises during the Warranty Period, Company will , at is options :
 - 1) Send the new parts to replace the defect parts.
 - 2) Exchange the affected Products with functionally equivalent Products that are new or formed from new and/or previously used parts that are equivalent to new in performance and reliability.
 - This warranty excludes damage resulting from abuse, accident, modifications, unauthorized repairs, neglect, abuse, water damage, or other causes that are not defects in materials and workmanship.
 - This warranty excludes normal depletion of consumable parts (grip tape, wheels & bearings) unless due to a defect in materials or workmanship.
 - This warranty excludes gifts.
-

FOR ALL RETURN and WARRANTY SHIPPING:

Please keep your shipping box. The warranty does not include damage from shipping in insufficient packaging.

BACKFIRE

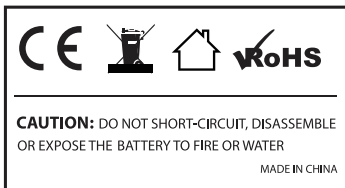

If you want to know about the BACKFIRE ,Please visit the website:
[Http://www.backfireboards.com](http://www.backfireboards.com)