



### WARRANTY & RATING



### SPECIFICATIONS

- Wattage: 3.5W
- Voltage: AC/DC 12-36V
- Luminous Flux: 260lm
- Beam Angle: 150°
- Color Rendering Index (CRI): 80
- Lifespan: 50,000hrs
- Light Source: LED
- Color Temperature (CCT): 3000K Warm White
- Waterproof Rating: IP65
- Operating Temperature: -13°F-113°F
- Material: Aluminum

### PRODUCT DESCRIPTION

This surface-mount Low Voltage Step & Deck Light, requiring no installation holes, is well-suited for extended steps due to its longer design. It operates on 12-36V AC/DC, ideal for railings with its 3.5-inch width and low voltage design, while its high voltage capacity reduces voltage drop. The downward lighting with a ribbed diffuser ensures glare prevention.

### FEATURES & BENEFITS

- No-cut installation, longer for wide steps
- Step/railing light, low voltage for efficiency and safety
- 12-36V compatibility, prevents voltage drop
- Downcast light, ribbed diffuser for no-glare
- IP65 weatherproof, 3-year warranty

### POWER AND ELECTRICAL FEATURES

- This light features a 3.5W power rating and operates on an AC/DC 12-36V range, designed to minimize voltage drop with its maximum support of 36V power supply.
- The wiring is UL certified, made of brass with an STP-1W specification, and measures 5 feet in length. Connections are made using waterproof caps for secure and safe electrical connections.

### DESIGN AND STRUCTURE

- The fixture boasts an Oil Rubbed Bronze aluminum casing, its extended length making it more suitable for longer steps than traditional models.
- Its low voltage design, approximately 3.5 inches in width and slim profile, make it ideal for placement in areas frequently touched by hands, such as railing lights.
- The downward lighting is complemented by a "ribbed" diffuser to effectively reduce glare.

### ADDITIONAL COMPONENTS

- Included with the light are 2 screws and 2 expansion screws for mounting, plus 2 waterproof caps for connecting wires, ensuring a complete installation kit is provided.

### LED AND OPTICAL PERFORMANCE

- This lighting unit is equipped with 27 pieces of 0.5W SMD2835 LEDs, delivering a Color Rendering Index (CRI) of 80.

### PRODUCT DIAGRAM

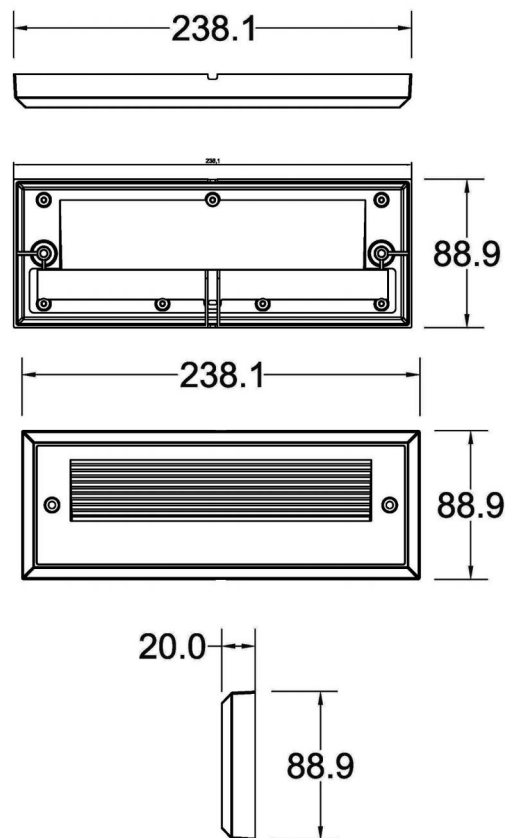

Size in mm  
1" = 25.4mm.

## Dual-Purpose Step and Deck Lights

Slim and safe, dual-purpose low-voltage lighting for steps and decks.



Tende Orizzontali Step & Deck Light



Retro Baffle Step & Deck Light

## 277V Compatible Commercial Step Lighting

Seamlessly integrates with commercial voltages.

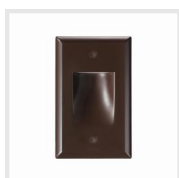

ZincTech Commercial Upright Gradience Step & Deck Light



ZincTech Commercial Parallel Gradience Step & Deck Light



ZincTech Commercial Louvered Step & Deck Light

## Classic Glow Series

Retro design meets modern lighting.

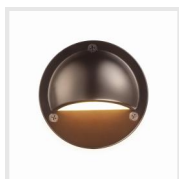

Semisfera Deck & Rail Light



Quadrifoglio Deck & Rail Light



Pro Parallel Retro Louvered Step & Deck Light

## Modern Elegance Series

Blending utility with modern aesthetics.



Affusolato Deck & Rail Light



Nova Deck & Rail Light



Vertebre Deck & Rail Light

## All Color Options

some models may have limited choices.



Satin Nickel

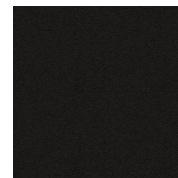

Matte Black



Oiled Rubbed Bronze

## Compatible Accessories



Outdoor Transformer, AC to DC, 12V 60W, Timer & Photocell



Outdoor Transformer, AC to DC, 12V 100W, Timer & Photocell



Outdoor Transformer, AC to DC, 12V 120W, Timer & Photocell



Waterproof Wire Nuts - Large (For terminals/multiple connections, fits 12AWG - 22AWG, up to 8 wires of 16/2)



Waterproof Wire Nuts - Medium (Fits 14AWG - 22AWG, up to 3 wires of 16/2)



Low Voltage Landscape Lighting Cable, 16/2

**Note:** Also available in 10/2, 12/2, 14/2 sizes.



Landscape Light Wire Connector (14-16 AWG Compatible)



EasyConnect Wire Connector (14-16 AWG Compatible)