

Assembly & Maintenance Guide



Jordaan+



LEKKER.



Contact

— Australia

Phone

+61 3 4828 3202 – Melbourne

+61 3 4828 3202 – Sydney

Address

23 Provost Street,

North Melbourne,

3051, VIC, Australia

415 Bourke Street, Surry Hills,

2010, NSW, Australia

Email

info.au@lekkerbikes.com

sydneystore@lekkerbikes.com

— Europe & USA

Phone

+31 6 81878491

Address

Tweede Kostverlorenkade 68

Amsterdam, The Netherlands

Email

info.eu@lekkerbikes.com

lekkerbikes.com



LEKKER

Warning

For safety purposes it is recommended that you have this bicycle assembled by a skilled bicycle mechanic.

Enjoy your Jordaan+

Dear LEKKER Customer, First and foremost – congratulations on your brand new bicycle! We can't wait for you to experience the thrill and joy of riding your LEKKER bike, the Amsterdam way. But before you do, we want to help you make sure your bike is in tip-top condition, as well as provide you with some tips and tricks to keep it that way.

This manual will outline all the tools and knowledge needed to put the finishing touches on your bike, as well as how to use it and useful guidance on maintenance and care. Feast your eyes on what's to come – we guarantee it'll be worthwhile, even if you're an experienced rider.

The first few chapters are particularly important, for both your enjoyment and safety, as we walk you through key steps in ensuring your bike is safe to ride.

SHIMANO

BAFANG

TEKTRO
BRAKE SYSTEMS

SAMSUNG

WTB

Note: We have to stress that this manual won't teach you all the skills of a bicycle mechanic. Even a manual the size of every Harry Potter book combined couldn't detail every possible combination, tricks and available components. For this reason, our manual is only applicable to your new LEKKER bicycle and its assembly, alongside any important notes, warnings and maintenance guides.



Index

p08	<u>01</u> Getting started
p12	<u>02</u> Fitting the saddle and handlebars
p14	<u>03</u> Fitting the pedals
p16	<u>04</u> Aligning the brakes
p18	<u>05</u> Aligning the gears
p20	<u>06</u> Battery set-up
p22	<u>07</u> Battery health
p26	<u>08</u> Display settings
p28	<u>09</u> Finishing touches
p28	<u>10</u> Safety & Warranty

01. Getting Started

We've created this manual to help you put the finishing touches on your LEKKER bike. Run through these quick steps and you'll be exploring and adventuring in no time.

So, without further ado, unbox your LEKKER bike and feast your eyes on your newest sidekick. Once you've removed the packaging, make sure you have your trusty toolkit to hand, as shown in the illustration on the next page.

You will also need to locate the small tube of assembly grease in the bike carton. You may need this for a couple of the steps to follow.

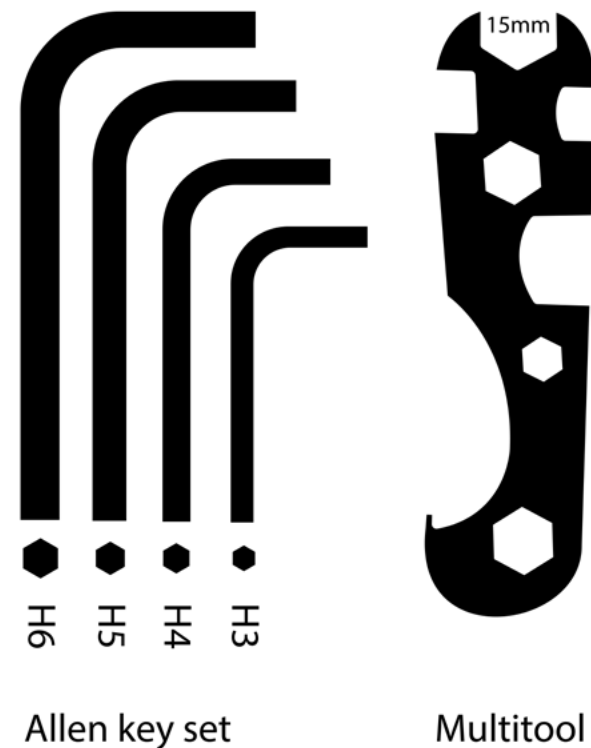



02. Fitting and adjusting the handlebars

Handlebars.

Step 1: First up, apply some assembly grease into the top of the fork steerer tube. Now, using a 6mm allen key, loosen the bolt located at the top of the handlebar stem. Don't undo the stem bolt more than 4 turns as it may come away from the stem. Then insert it into the top of the fork steerer. Once inserted, centre the handlebar and stem and tighten it.

Step 2: To adjust the angle of the handlebar, loosen the allen bolts of the front plate until you can move the handle bar freely. Once you've found your preferred bar angle, tighten the bolt.

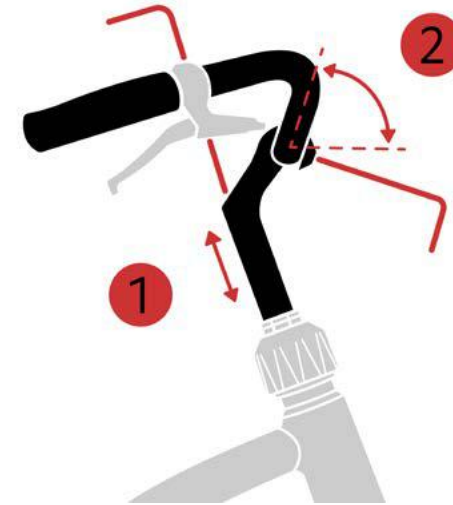

Tip: Should you wish to adjust the angles of your grips, brakes and shifter, you can do so with a simple turn of allen key 3 or 4. However, this should be correctly set already.

Steering Lock.

Simply turn clockwise to engage the lock, or anti clockwise to disengage.

03. Fitting the pedals

First up, add a small amount of assembly grease to the pedal threads on either the pedals or the crank arms. To assemble the pedals, you will need a 15mm open-ended spanner. Insert the pedal into the crank and ensure the pedals are properly tightened. Please see below for which pedal should go on each side of the bike.

LEFT pedal: this is the pedal that has indented horizontal lines on the small part between the pedal and thread.

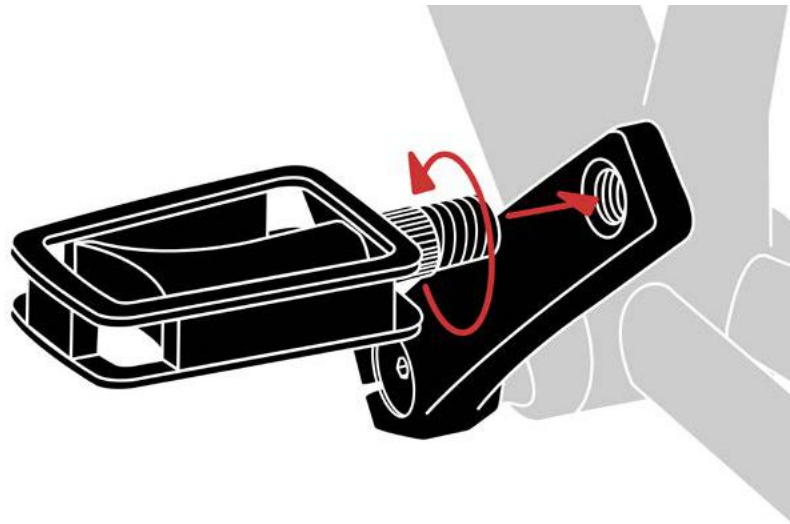

RIGHT pedal: this pedal has no indented lines and is smooth in between the pedal and thread.

ATTENTION: please make sure you check the thread direction before inserting the pedals. Fitting the pedal to the wrong side can damage the crank arm and is not covered under warranty.

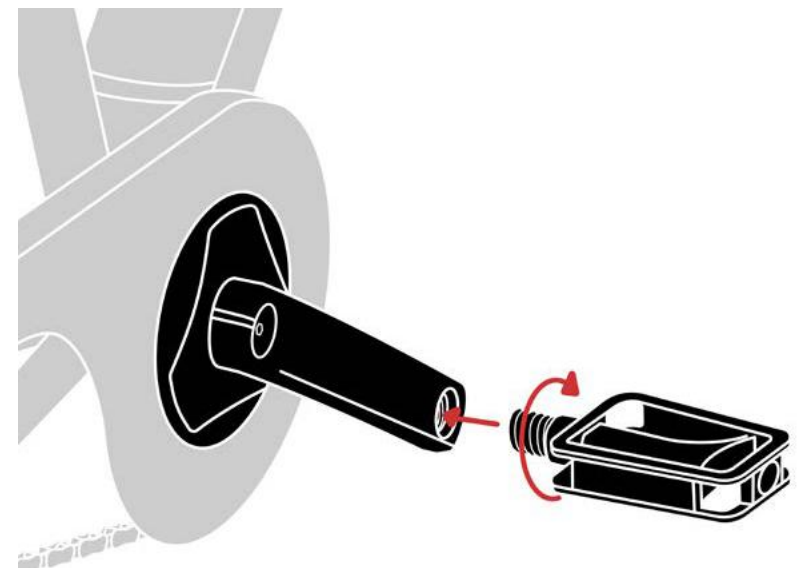

04. Aligning the brakes

Lift the wheel off the ground and give it a spin. It should spin freely and without any noise. If you hear a metallic rubbing sound, then the brakes will need adjusting.

To do this, you'll need to use the 5mm allen key. With the bike upside down, adjust the caliper. You will need to slightly loosen the two 5mm allen key bolts (found on the top of the caliper), so that you can gently move the caliper horizontally, allowing the disc rotor to move freely between the brake pads.

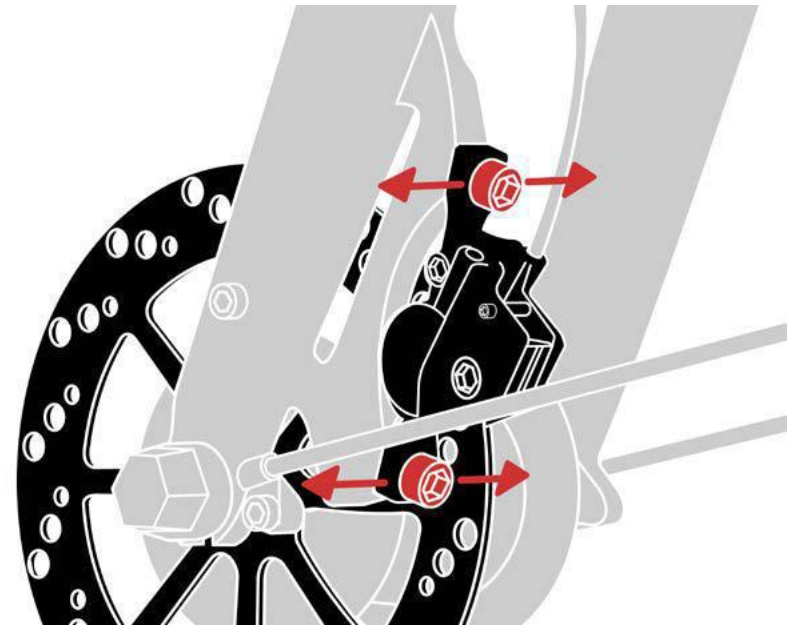

05. Aligning the gears

Step 1: Checking alignment

Begin by engaging the second gear on your shifting system. With the second gear engaged, the yellow indicator needs to be located between the two white lines on the gear display of the rear hub.

Step 2: Adjusting alignment

If the yellow indicator is not located between the two lines, you will need to centre it.

To do this, begin by loosening the lock nut with a 10 mm open-ended spanner. With the nut loosened, you can adjust the gears using the barrel adjuster. Turn the barrel adjuster until the yellow indicator is between the two lines. Once the gears are aligned, tighten and secure the nut.

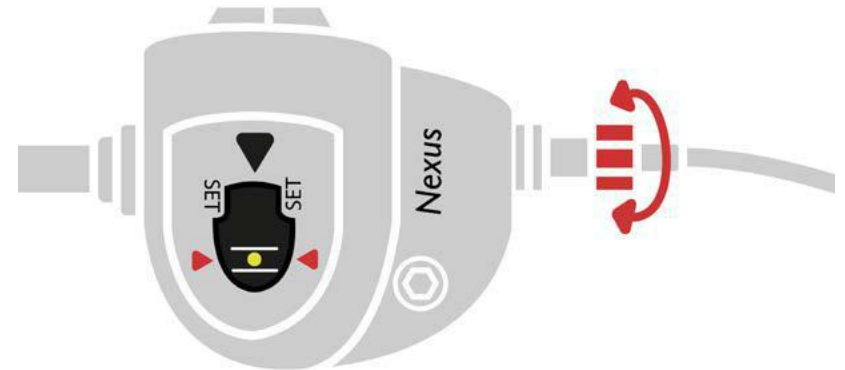

06. Battery set-up

Make sure that the battery is properly inserted into the frame. When you feel a click, you'll know it's been locked into place. Using your battery lock key (1 in the illustration), you can easily remove the battery for charging. Your battery can be charged whilst the battery is inside the frame, or you can simply take it out (2 in the illustration) and charge it separately. Remember to remove the key from the battery lock whilst riding.

All batteries will come partially charged. However, to get the most out of your battery and allow it to reach full charging capacity, we recommend that you fully charge it before your first ride and then charge it for 12 hour cycles, for its first three charges.

Once you've finished inserting the battery, it's time to turn the bike on!

Note: All batteries and frames are water-resistant, but if you are storing the bike outside overnight, or for long periods of time, we recommend that the battery is removed and kept inside and the bike is covered and stored. Removing the battery overnight will not only help to maximize its overall lifespan, but also lower the risk of theft.

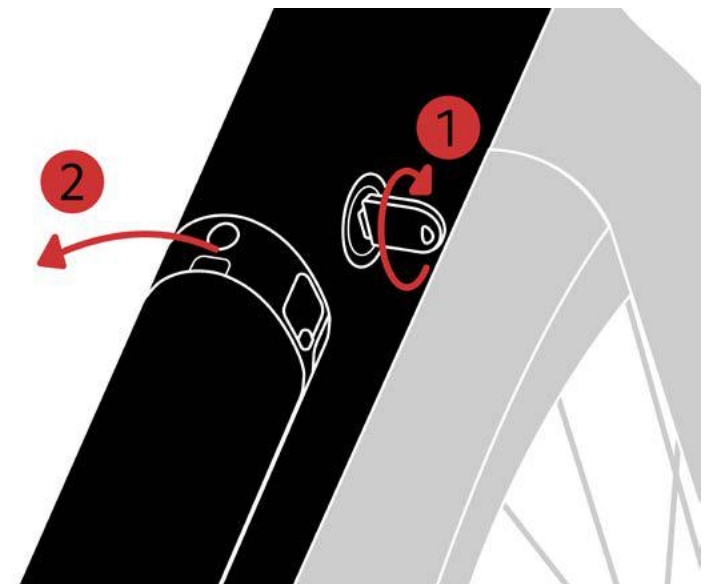

07. Battery Health

Below you'll find a few tips and tricks to help optimise your new e-bike battery's performance and lifespan:

1. Never leave your battery flat. Doing so causes irreparable damage and drastically shortens its lifespan.

2. Store your battery with 50 - 80% charge. Charging up to 100% is fine, but avoid storing it at 100% for an extended period (i.e. longer than a month). If possible, also remove your battery from your bike during storage.

3. Store your battery in a dry, cool place, out of direct sunlight and at a temperature between 5 - 20°C (41 - 68°F). If you're using your bike during warmer summer days, remove your battery when possible. Similarly, if you keep your bike outside during the winter, remove your battery if it's freezing or snowing.

4. Our smart charger automatically detects when your battery is fully charged and will then stop charging. However, we recommend that you disconnect the charger when the battery is fully charged and the indicator light on the charger switches from red to green. For safety reasons, we also advise that you do not leave your battery charging whilst unattended.

5. Your LEKKER bike comes with the Bafang C11 display, which gives you an indication of your battery's remaining range. However, this number does not factor in your weight, terrain, temperature and riding style. For these reasons, it should only be used as a rough and relative guide, not an absolute number.

07. Battery Health

6. What factors will affect my battery's range?

- Rider weight & load (Racks, pannier bags, Child seat).
- Environmental factors such as terrain, gradient, ambient temperature & wind. Lower outside temperatures will negatively impact your bike's range.
- Assistance level that's selected on the Bafang E-system.
- Cadence Efficiency: Drive-train systems will affect how efficiently your bike will consume energy. For example single speed on the Amsterdam+ vs Amsterdam GT with Evnviolo Step-less. A variable ratio drive-train allows for more efficient use of energy than a fixed ratio.

- Torque rating of your motor; a 80Nm torque mid-motor will help you accelerate faster than a 32Nm hub motor, but will also consume more energy in the process.

- Battery capacity; the larger the capacity, the more range the bike will have.

- Battery age; over time your battery will lose the ability to store charge. The above points will help slow down this process.

7. Using your e-Bike battery is better than not. So hop on your bike and (regularly) take it for a spin!

08. Display Settings

We recommend that you sit on your bike before you turn it on. This means you'll have full control over the bike and can avoid any accidents.

To turn on your Jordaan+, using the display that's on the left hand side of your handlebar, press and hold the power button for 2 seconds. This will turn on the screen.

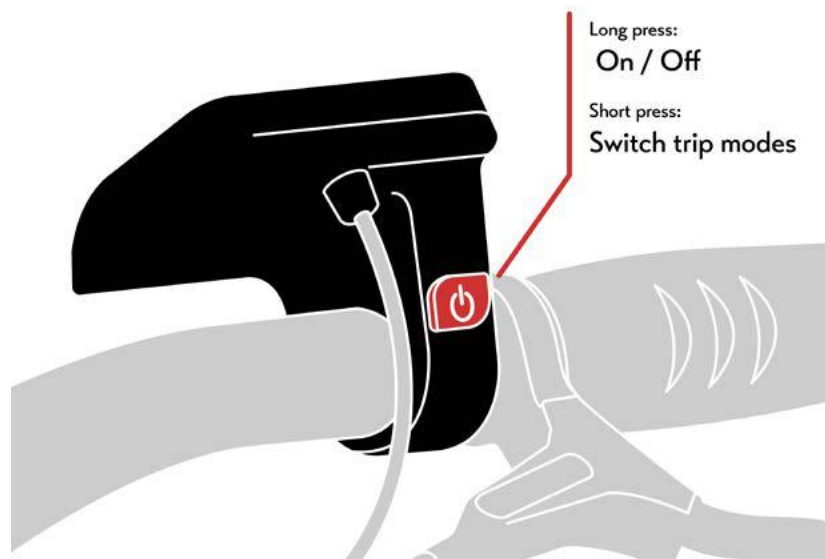

Once on, you can scroll through the 5 levels of motor assist using the + and - buttons on the front of the control module / display. For more in-depth instructions for your screen, please refer to the Bafang manual, found in PDF format on our website.

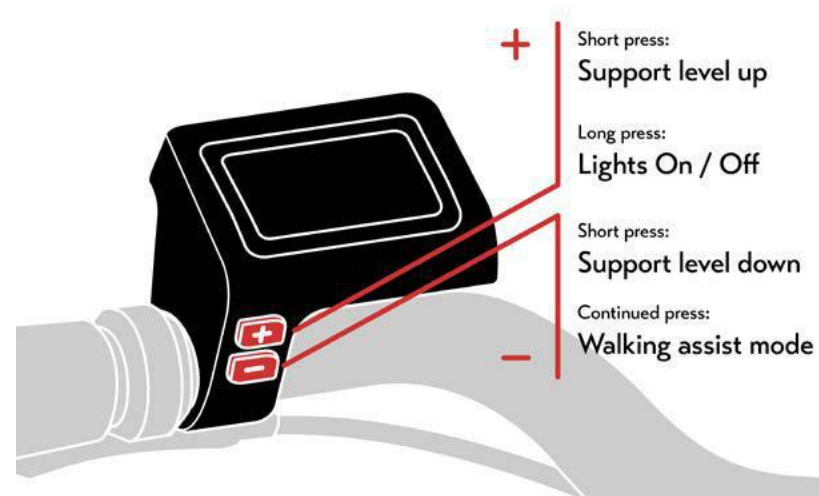

Finally, to turn on your front light, press and hold the + button for 2 seconds.

09. Finishing Touches

Saddle.

Using a 5mm allen key, loosen the seat post clamp bolt and adjust the seat post height. Ensure it's at the correct height for you, and tighten the bolt.

Tip: Your knee should slightly bend when the pedal is at its lowest position while sitting on the saddle. You may wish to apply some assembly grease to the seat post here. Some bikes have had this done at the factory so this may not be needed.

Bell, Tyres and Accessories.

Install the bell on your handlebars, in your preferred position.

Pump the tyres to 40-50 PSI

If you've ordered any accessories such as racks, locks or lights, don't forget to fit these too. They each come with their own instructions and also have their own mounting points.

Now, you're good to go. Enjoy your ride, the Amsterdam way!



10. Safety and warranty

We offer a 3-year warranty on our LEKKER frames. Additionally, we supply you with 2 years warranty on the components of our different models starting on the day of purchase. This warranty is only for replaceable components. Unfortunately, our warranty is not transferable (including when sold to another consumer) and can only be used by the original buyer of a LEKKER product. If you want to use the warranty, please ensure you have your receipt and go to the original shop in which you made your purchase.

There are cases when our warranty isn't valid. Our warranty doesn't cover wear and tear, incorrect assembly or maintenance. There's no warranty in the case of; damage caused by accidents, improper use or negligence. Our warranty is also void if changes are made to the original design of the LEKKER bike.

All pedelec eBikes must be limited to 250w power output and motor assist cannot exceed 25km/h. LEKKER Bikes will not be held liable for any aftermarket modifications to the motor or system that may have an effect on its performance.

Do not make any changes to your electric system or fit any other products to it, aimed at increasing the power output from your eBike. As a rule, you will shorten the service life of the system, risk damaging the Drive Unit (motor) and also the e-bike itself. There's also the danger that you'll void the warranty of your ebike. Furthermore, as a result of inexpert work on the system you will jeopardise your own safety, as well as that of other road users. Risking accidents caused by manipulations can lead to high personal liability costs and potentially even the danger of criminal prosecution.

Please note: your frame number is located on the bottom of the bike frame, near the bottom bracket. This might be needed for insurance purposes.

**Assembly &
Maintenance Guide**

Jordaan+

lekerbikes.com

