

# Assembly & Maintenance Guide



LEKKER®

Amsterdam GTS



## Contact

### Australia & USA

#### Sydney

+61 3 4828 3202

sydneystore@lekkerbikes.com

134 Botany Rd Alexandria

NSW 2015, Australia

#### Melbourne

+61 3 4828 3202

info.au@lekkerbikes.com

23 Provost Street Nth. Melbourn-

ne VIC 3051, Australia

#### Brisbane

+61 3 4160 6003

brisbanestore@lekkerbikes.com

2C 97 Sandgate Road Albion

4010 QLD, Australia

#### Warning

For safety purposes it is recommended that you have this bicycle assembled by a skilled bicycle mechanic.

### Europe

#### Amsterdam

Tweede Kostverlorenkade 68

Amsterdam, The Netherlands

#### Berlin

Kollwitzstraße 47

10405 Berlin, Germany

\*Check our website for contact info.

# Enjoy your Amsterdam GTS

Dear LEKKER Customer, First and foremost – congratulations on your brand new bicycle! We can't wait for you to experience the thrill and joy of riding your LEKKER bike, the Amsterdam way. But before you do, we want to help you make sure your bike is in tip-top condition, as well as provide you with some tips and tricks to keep it that way.

This manual will outline all the tools and knowledge needed to put the finishing touches on your bike, as well as how to use it and useful guidance on maintenance and care. Feast your eyes on what's to come – we guarantee it'll be worthwhile, even if you're an experienced rider.

Please read all the chapters, as we walk you through key steps in ensuring your bike is ready and safe to ride.

Please make sure that you write down your frame number, which is located below the bottom bracket. Also write down your key numbers (battery key, lock key). This information can be useful for insurance and in case of theft.

SHIMANO

BAFANG

TEKTRO  
BRAKE SYSTEMS

SAMSUNG

WTB

Note: We have to stress that this manual won't teach you all the skills of a bicycle mechanic. Even a manual the size of every Harry Potter book combined couldn't detail every possible combination, tricks and available components. For this reason, our manual is only applicable to your new LEKKER bicycle and its assembly, alongside any important notes, warnings and maintenance guides.



# Index

## Assembly

- p10**     01.  
Unpacking your bike and experience box
- p12**     02.  
Fitting the handlebars
- p14**     03.  
Fitting the pedals
- p16**     04.  
Battery setup
- p18**     05.  
Getting ready to ride
- p20**     06.  
Finishing touches

## Maintenance

- p24**     01.  
Aligning the brakes
- p26**     02.  
Battery health
- p30**     03.  
Safety and warranty



Assembly

# 01. Unpacking your bike and experience box

We've created this manual to help you put the finishing touches on your LEKKER bike. Run through these quick steps and you'll be exploring and adventuring in no time.

So, without further ado, unbox your LEKKER bike and feast your eyes on your newest sidekick. Once you've removed the packaging, make sure you have your trusty toolkit to hand, as shown in the illustration on the next page.

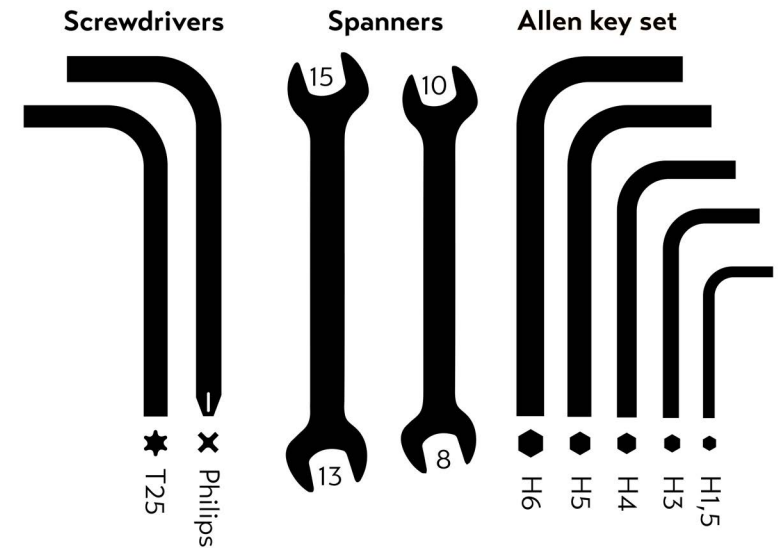

## 02. Fitting the handlebars

Step 1: Loosen the two stem bolts using the 4mm allen key. Next, align the handlebars so that they are perpendicular to the front wheel. Then, tighten the two bolts.

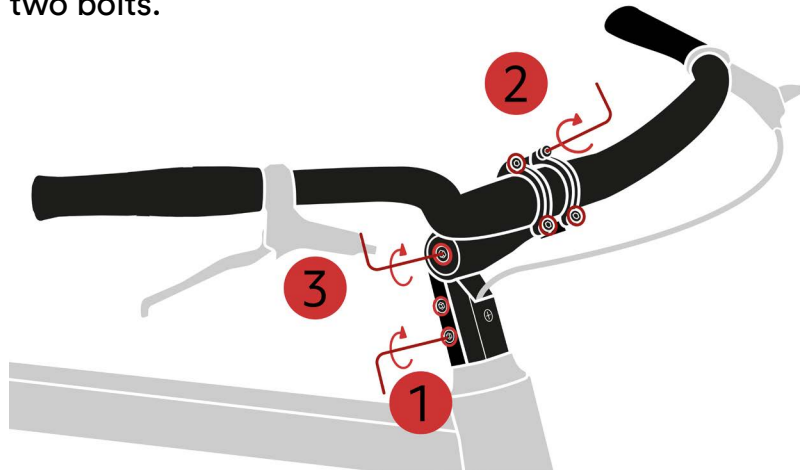

Step 2: To adjust the angle of the handlebar, use the same tool to loosen the faceplate at the front of the handlebar stem and reposition the handlebars. Then, tighten the handlebar to the stem with the four bolts.

Step 3: To adjust the height of the handlebars use the 4mm allen key to adjust the angle of the stem.

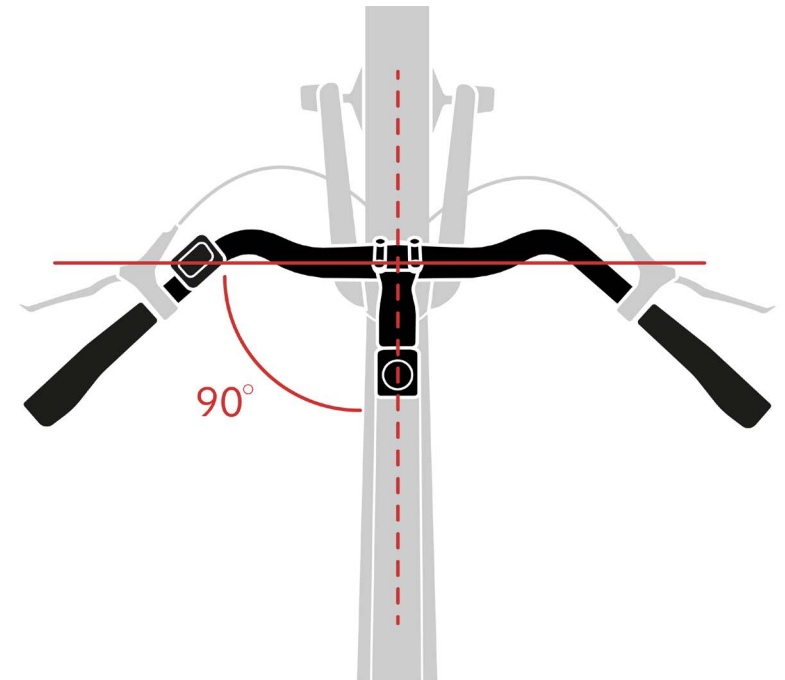

Tip: Should you wish to adjust the angles of your grips, brakes and shifter, you can do so with a simple turn of allen key 3 or 4. However, this should be correctly set already.

# 03. Fitting the pedals

To assemble the pedals, you will need a 15mm open-ended spanner. Insert the pedal into the crank and ensure the pedal is properly tightened. Please see below which pedal should go on each side of the bike.

LEFT pedal: this is the pedal that has indented horizontal lines on the small part between the pedal and thread.

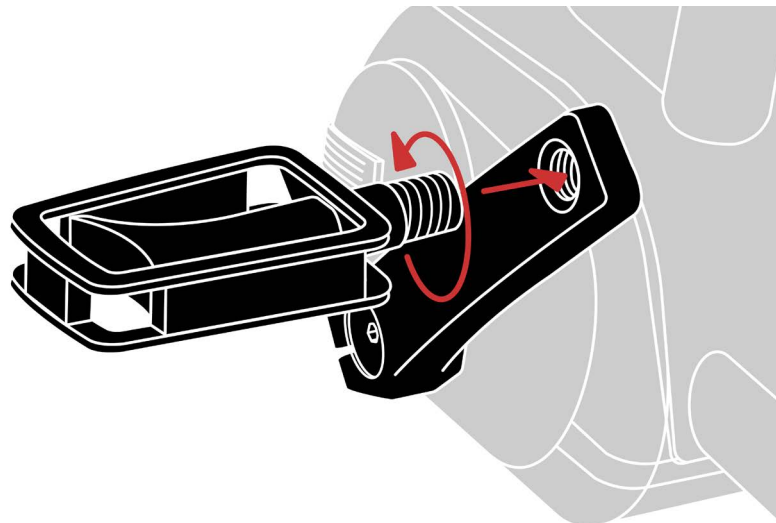

RIGHT pedal: this pedal has no indented lines and is smooth in between the pedal and thread.

ATTENTION: please make sure you check the thread direction before inserting the pedals. Fitting the pedal to the wrong side can damage the crank arm which is not covered under warranty.

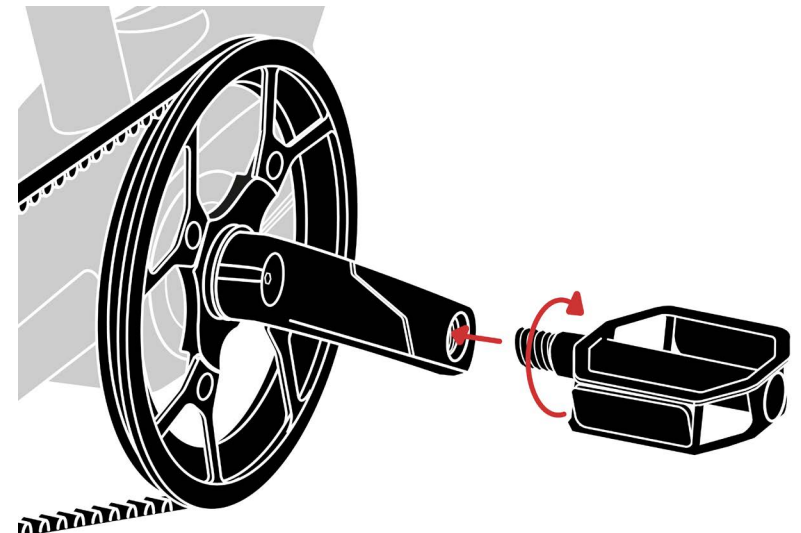



# 04. Battery setup

Make sure that the battery is properly inserted into the frame. When you feel a click, you'll know it's been locked into place. Your battery can be charged whilst the battery is inside the frame, or you can simply take it out and charge it separately.

Step 1: Insert the battery key into the keyhole in the frame to unlock your battery. Make sure to insert it in the keyhole, and not the charging port as this could cause a short circuit.

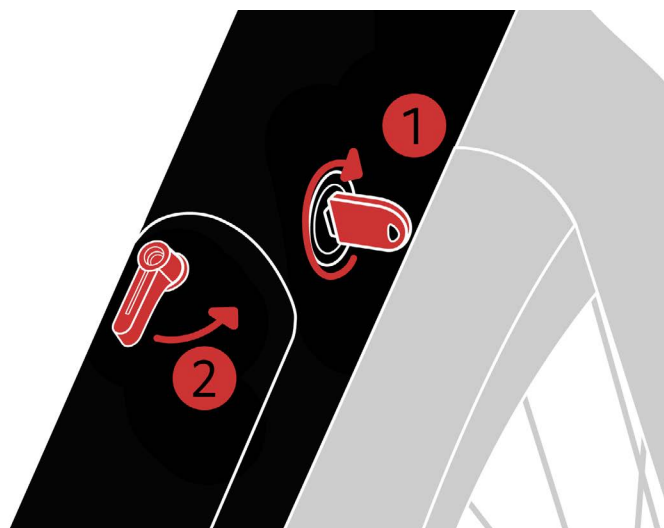

Step 2: After turning the key, the battery will partially pop out. Move the lever to fully release the battery.

Remember to remove the key from the battery lock whilst riding. All batteries will come partially charged. However, to get the most out of your battery, we strongly recommend that you check out chapter 2 of the Maintenance part of this manual, all about battery health. Once you've finished inserting the battery, it's time to turn the bike on!

Note: All batteries and frames are water-resistant, but if you are storing the bike outside overnight, or for long periods of time, we recommend that the battery is removed and kept inside and the bike is covered and stored. Removing the battery overnight will not only help to maximize its overall lifespan, but also lower the risk of theft.

# 05. Getting ready to ride

## To power on your eBike:

1. Take a seat on your eBike for better control
2. Press and hold the power button on your remote on the handlebar for 2 seconds until the screen activates.

## Once the screen is active:

Use the + and - buttons to scroll through the 5 levels of motor assist.

Press and hold the 'light' button for 1 second to turn on your front and rear lights.

Press the 'i' button to go to the settings of the display.

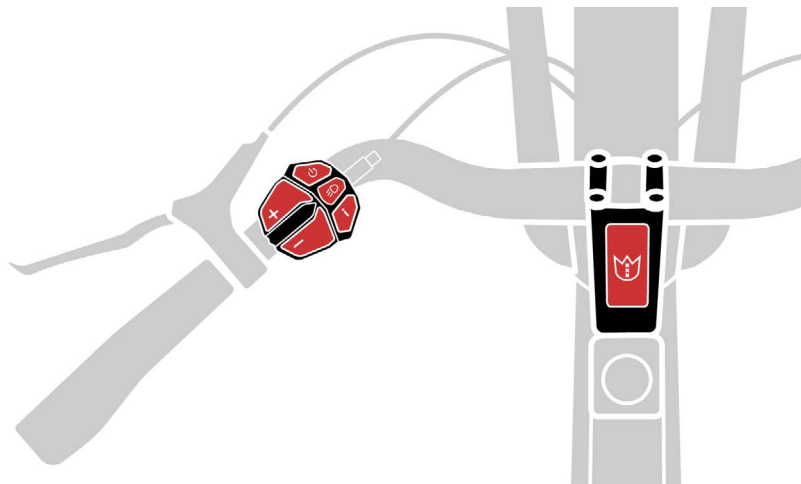

You can charge your phone through your display by using the USB charging port (0.5A) located at the bottom of the display.

For detailed screen instructions please refer to the Seekrun Q1 manual in PDF format (or video) on our website.

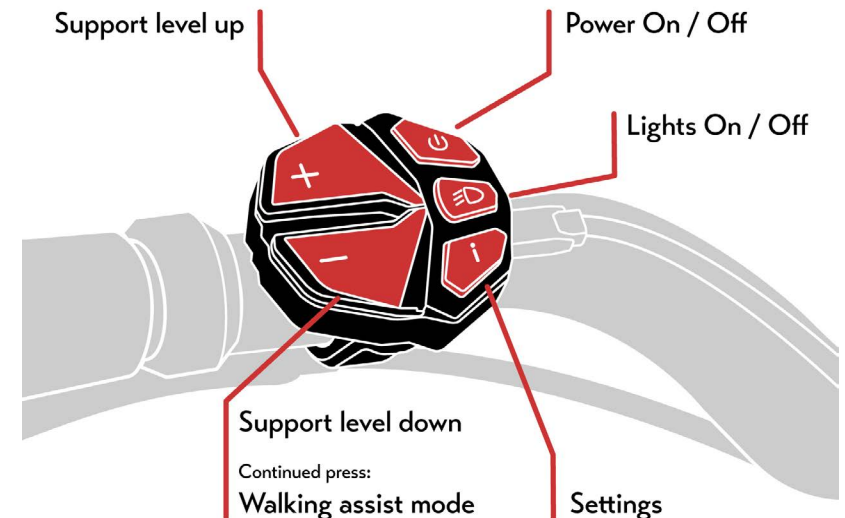

# 06. Finishing touches

## Tyres

Pump the tyres to 3.1 - 4.5 Bar (45-65 PSI)

## Saddle

Using a 5mm allen key, loosen the seatpost clamp bolt and adjust the seatpost height. Ensure it's at the correct height for you, and tighten the bolt.

Tip: Your knee should slightly bend when the pedal is at its lowest position while sitting on the saddle.

## Safety

Install the bell on your handlebars, in your preferred position. Generally, this is on the left hand side, next to the brake lever. Don't forget to install the reflectors for optimal visibility during your ride.

If you've ordered any accessories such as racks, locks or lights, don't forget to fit these too.

Now, you're good to go. Enjoy your ride, the Amsterdam way!

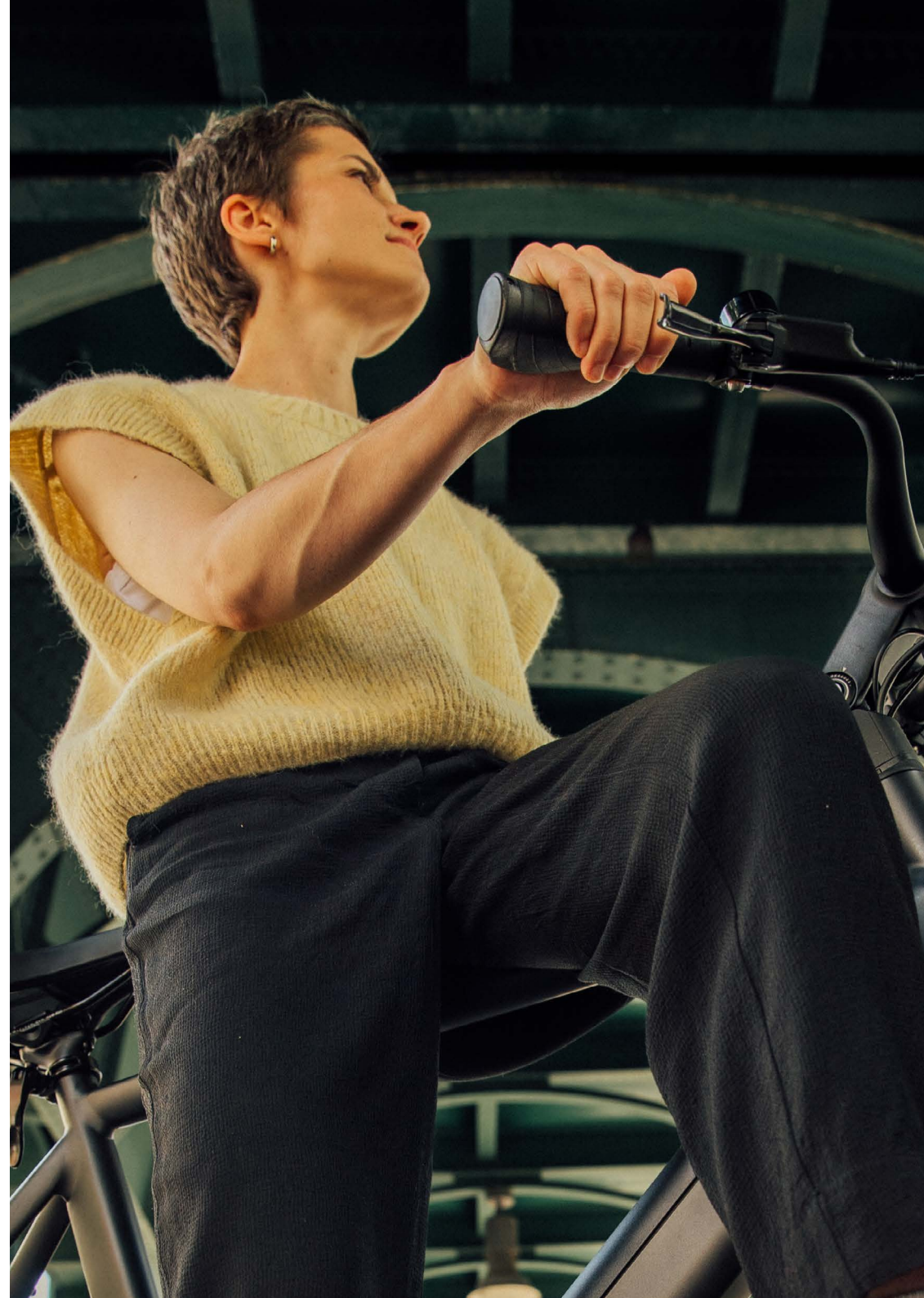



Maintenance

# 01. Aligning the brakes

Lift the wheel off the ground and give it a spin. It should spin freely and not make any noise. If you hear a metallic rubbing sound, then the brakes will need adjusting.

To do this, you'll need to use the 5mm allen key. With the bike upside down, adjust the caliper. You will need to slightly loosen the two 5mm allen key bolts (found on the top of the caliper), so that you can gently move the caliper horizontally, allowing the disc rotor to move freely between the brake pads.

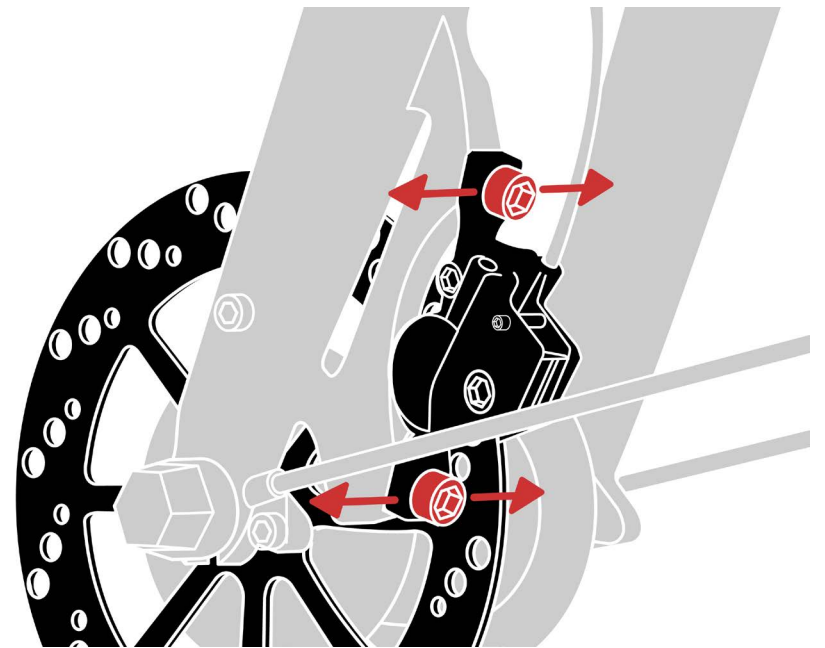

## 02. Battery health

Below, you'll see a few tips and tricks to help optimise your new eBike battery's performance and lifespan:

1. Never leave your battery flat. Doing so causes irreparable damage and drastically shortens its lifespan.
2. Store your battery with 50 - 80% charge. Charging up to 100% is fine, but avoid storing it at 100% for an extended period (i.e. longer than a month). If possible, also remove your battery from your bike during storage.
3. Store your battery in a dry, cool place, out of direct sunlight and at a temperature between 5 - 20°C (41 - 68°F). If you're using your bike during warmer summer days, remove your battery when possible. Similarly, if you keep your bike outside during the winter, remove your battery if it's freezing or snowing.
4. Our smart charger automatically detects when your battery is fully charged and will then stop charging. However, we recommend that you disconnect the charger when the battery is fully charged and the indicator light on the charger switches from red to green. For safety reasons, we also advise that you do not leave your battery charging whilst unattended.
5. Your LEKKER bike comes with the Bafang C11 display, which gives you an indication of your battery's remaining range. However, this number does not factor in your weight, terrain, temperature and riding style. For these reasons, it should only be used as a rough indication, not an absolute number.

## 6. What factors will affect my battery's range?

- Rider weight & load (Racks, pannier bags, Child seat).
- Environmental factors such as terrain, gradient, ambient temperature & wind. Lower outside temperatures will negatively impact your bike's range.
- Assistance level that's selected on the Bafang E-system.
- Torque rating of your motor; a 80Nm torque mid-motor will help you accelerate faster than a 32Nm hub motor, but will also consume more energy in the process.

- Battery capacity; the larger the capacity, the more range the bike will have.
- Battery age; over time your battery will lose the ability to store charge. The above points will help slow down this process.

7. Using your eBike battery is better than not. So hop on your bike and (regularly) take it for a spin!

## 03. Safety and warranty

We offer a 2-year warranty on our LEKKER frames. Additionally, we supply you with 2 years warranty on the components of our different models starting on the day of purchase. This warranty is only for replaceable components. Unfortunately, our warranty is not transferable (including when sold to another consumer) and can only be used by the original buyer of a LEKKER product. If you want to use the warranty, please ensure you have your receipt and go to the original shop where you made your purchase.

There are cases when our warranty isn't valid. Our warranty doesn't cover wear and tear, incorrect assembly or maintenance. There's no warranty in the case of; damage caused by accidents, improper use or negligence. Our warranty is also void if changes are made to the original design of the LEKKER bike.

All pedelec eBikes must be limited to 250w power output and motor assist cannot exceed 25km/h. LEKKER Bikes will not be held liable for any aftermarket modifications to the motor or system that may have an effect on its performance.

Do not make any changes to your electric system or fit any other products to it, aimed at increasing the power output from your eBike. As a rule, you will shorten the service life of the system, risk damaging the Drive Unit (motor) and also the eBike itself. There's also the danger that you'll void the warranty of your eBike. Furthermore, as a result of inexpert work on the system you will jeopardise your own safety, as well as that of other road users. Risking accidents caused by customisations can lead to high personal liability costs and potentially even the danger of criminal prosecution.

Please note: your frame number is located on the bottom of the bike frame, near the bottom bracket. This might be needed for insurance purposes.





Assembly &  
Maintenance Guide

Amsterdam GTS

[lekerbikes.com](https://lekerbikes.com)

