

quest 4.0

ADJUSTABLE BASE



ADJUSTABLE BASE | OWNER'S MANUAL

Actual product appearance and functionality may vary from photographs, illustrations and descriptions included in this manual.

table of contents

- Safety Precautions and Usage Statements 1-3
- Parts List 4
- Base and Remote Overview 5
- Quick Reference Guide 6
- Installation Guide 7-8
- Offline Voice Control Puck with Wireless Charger 9-10
- Offline Voice Control Puck Commands 11
- Remote Control 12-13
- Remote Control Pairing 14
- Connecting Strap 15
- Syncing Two Bases 16
- Headboard Bracket Installation Guide (Optional) 17
- Emergency Battery Backup Strap 18
- Troubleshooting 19
- 10 Year Limited Warranty 20

safety precautions and usage statements

Attention: Important Safety Disclaimers

Read the following information before using this product. Failure to use a surge protection device could compromise safety or cause product malfunction and could void the electrical portion of your warranty.

TO REDUCE THE RISK OF SHOCK, BURNS, FIRE OR INJURY:

For optimal safety and operation, plug bed base into a surge protector (not included). The bed base should only be plugged directly into a wall outlet or surge protector (strongly recommended). Always unplug the base from the electrical outlet before servicing any part of the base. To reduce risk of electric shock, unplug the base before cleaning. To safely disconnect, ensure the base is in a flat position with all motors off, and unplug from power source. Keep the power cord away from heated surfaces. Never operate the base when the air openings are blocked. Keep air openings free of lint, hair and the like. Do not drop or insert any object into any opening. Discontinue use of the bed base and contact a qualified service center if: it has a damaged cord or plug, if it is not working properly, or it has been dropped into water. Only use this bed base for its intended use as described in this manual. Do not use accessories/attachments that are not recommended by the manufacturer. Close supervision is required when the bed base is used by or near children, convalescents, disabled persons or pets. Improper connection of the equipment can result in the risk of electrical shock, electrical fire or faulty operation of this bed base. If the plug does not fit your outlet, contact a qualified electrician to install a suitable outlet. Unauthorized modification or failure to use a wall outlet or surge protector could void the electrical portion of your warranty.

CHILDREN AND PETS:

Immediately dispose of all packing materials as it may pose a smothering risk to small children and pets. To avoid injury, it is not advised to allow children and small pets to play on or under the bed. Children should not operate the bed base without adult supervision.

SAFETY FEATURES:

Manual operation – If something gets caught in the platform when flattened, you can manually raise the platform up by lifting at both the head and foot to relieve pressure and allow for release.

Emergency stop – Stop the motion of the platform by pressing any button on the remote control.

Power outage – Use the “Emergency Battery Backup Strap” as a temporary power source to get the base to a desired position. Instructions on how to operate the Battery Backup Box are on the Emergency Battery Backup page(s).

PACEMAKERS:

Some products contain Neodymium MAGNETS which may interfere with devices such as pacemakers, ICD’s and any other device sensitive to magnetic fields. It is STRONGLY recommended that owners of such medical devices consult their physician prior to using products that contain Neodymium MAGNETS. It is also possible that some pacemakers may falsely interpret the optional massage feature vibrations as movement/exercise. This is a common occurrence with any product that creates a vibrating movement and may affect the pacemaker. Please consult your physician before using the massage feature.

IN-HOME USE AND HOSPITAL STANDARDS:

Ergo adjustable bed bases are designed solely for in-home use. This base was not designed as a hospital bed and is not designed to meet hospital standards. Do not use this base with TENT TYPE oxygen therapy equipment or near explosive gases.

ADDITIONAL SAFETY FEATURES

Casters (optional leg accessory) are equipped with locking wheels to prevent unwanted movement. Even when locked and unable to roll, it is possible for the casters to slide. Free release head and foot motors are designed to lower the mattress by retracting only with gravity, never pulling downwards, which minimizes pinch points

LIFTING/LOWERING MECHANISMS

The lift/lower feature will emit a minimal humming sound during operation.

safety precautions and usage statements

This is normal. During operation, the lift arm wheels make contact with the platform support of the base. This contact may result in metal on metal or metal on plastic contact. This applies slight tension on the moving components and resonance is reduced to a minimum level. If excessive noise or vibration is experienced, reverse the movement action (up or down) of the base with the remote control. This should realign the base's activating mechanisms to the proper operational position. In normal base operation, the wheels, which allow the bed to maintain its distance from the wall, will make contact with the steel platform supports of the base creating a contact noise. When entering, exiting or shifting weight on the base, this contact noise may be audible as the wheels make contact. This is normal.

MATERIALS

Ergo adjustable bases are constructed from various materials including woods, metals, plastics and fabrics. Tension, pressure or movement applied to the frame, platform or shroud through general use may create an audible sound.

MASSAGE OPERATION AND LOCATION ENVIRONMENT

The massage feature will emit a tone during operation. This is normal. As the massage intensity level is increased, the tone will intensify. The volume of this tone is directly related to the location environment. For example, when demonstrated in a show room, the surrounding environmental noise will cover some of the massage noise. However, when installed in a home setting with wooden floors, carpeted or not, the massage volume will be more noticeable. To minimize this resonance, place a piece of carpet, or rubber caster cups, under each leg or caster of the base. It is possible to experience vibration or noise from the exterior bed frame, headboard brackets, headboards or footboards if mounting bolts are not firmly tightened.

Levels 1-3 of massage intensity represent the revolutions of the motor per minute. Level 3 provides the maximum number of RPMs. However, this does not mean that the feeling of vibration is the strongest. Depending on the mattress material, thickness, and positioning of the user, the feeling of vibrations will differ. We encourage the user to find the massage intensity setting that suits them best. It is important to understand the physics of vibrations. Just as an engine may run rough during idle, as the RPMs increase,

the vibrations change concurrently.

TOLERANCE

All Ergo adjustable foundations, depending on make and model, are designed and manufactured to perform and function within designated quality control parameters. Bases are subject to meticulous and rigorous inspections during the quality control process to ensure bases will operate within these standards during normal operating use. Normal operating use is defined as the following: Adjustable foundation is to be operated with a mattress and load. Testing procedures require lifetime cycle tests with up to 120kg distributed load. The angle (designated "α" in figure 1) between the back section and the flat section for various configurations of the mattress support platform shall be $\pm 3^\circ$, which translates to a tolerance of up to 1 ½".

The angle (designated "β" in figure 1) between the flat section and foot section for various configurations of the mattress support platform shall be $\pm 3^\circ$, which translates to a tolerance of up to ¾".

Any adjustable foundation deemed to be within these allocated tolerances is considered to have met the manufacturer's quality control standards.

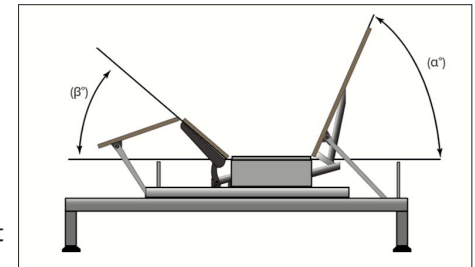

THAT "NEW PRODUCT" SMELL:

Some people notice a slight odor to their new adjustable base—this can come from our material manufacturing process. This smell is normal and usually disappears before the product reaches you. Sometimes, however, this smell may still be noticeable. It usually disappears after a few weeks, providing adequate ventilation of the product and the environment.

BREAK IN PERIOD:

You can speed up the break-in period by simply spending time in the adjustable bed through activities such as reading, watching TV or playing with the kids or grandkids. The extra movement will help the adjustable base

safety precautions and usage statements

respond to weight and temperature changes. Some of the materials in our adjustable bases such as the woods, metals and plastics used in the platform, frame and components are sensitive to moisture content and temperature and may make sounds in colder environments.

PAIRED OPERATION:

When operating a “paired” split base setup there may be a time latency up to 1.5 seconds between each bases articulation.

WEAR AND TEAR:

Wear and tear is damage that naturally and inevitably occurs as a result of normal use or aging.

FABRIC CARE:

To prolong the life of your fabric, protect from direct sunlight whenever possible. For spot cleaning, wipe area with a light damp sponge or vacuum with a soft brush attachment to remove particles. Keep at a minimum of 30cm (12 inches) away from direct heat sources. For a deeper cleaning, blot liquid spills with a clean dry cloth. Wipe with a clean cloth dampened with warm water. Do not wet excessively. A soft bristle brush may be used to remove ingrained soil. Avoid scratching by gentle brushing. Wipe with a clean cloth dampened with warm water to remove residues. Dry in shade away from direct heat. If persistent marks remain visible after cleaning, seek professional advice.

PRODUCT RATINGS:

The lift motors are not designed to operate continuously for more than [2] minutes in an [18] minute time period or approximately 10% duty cycle. Attempting to circumvent or exceed this rating will shorten the life expectancy of the product and may void the warranty. The massage motors are not designed to operate continuously for more than 30 minutes at a time. Please allow the massaging system to rest for 30 minutes after automatic massage shut off before restarting.

WEIGHT LIMITS:

This product is not rated to support weights in excess of 750 pounds. The

base will structurally support this weight, provided it is evenly distributed across the bed base. The adjustable base is not designed to support or lift this amount in the head or foot sections alone. Exceeding this weight restriction could damage the bed and/or cause injury and will void the warranty.

SAVE THESE INSTRUCTIONS.

FCC Compliance:

NOTE: This equipment has been tested and found to comply with the limits for a Class B digital device, pursuant to part 15 of the FCC Rules. These limits are designed to provide reasonable protection against harmful interference in a residential installation. This equipment generates, uses and can radiate radio frequency energy and, if not installed and used in accordance with the instructions, may cause harmful interference to radio communications. However, there is no guarantee that interference will not occur in a particular installation. If this equipment does cause harmful interference to radio or television reception, which can be determined by turning the equipment off and on, the user is encouraged to try to correct the interference by one or more of the following measures:

- Reorient or relocate the receiving antenna.
- Increase the separation between the equipment and receiver.
- Connect the equipment into an outlet on a circuit different from that to which the receiver is connected.
- Consult the dealer or an experienced radio/TV technician for help.

parts list

Before discarding the packing materials - ensure all the parts are accounted for.

All electronics and components that need to be installed are located in boxes under the base or attached to the frame.

- A) Wireless Remote Control (1)
- B) Mattress Retainer Bar (1)*
- C) Legs (6)
- D) Power Cord (1)
- E) Power Supply (1)
- F) Sync Cord ‡
- G) Battery Backup Strap (1)
(2) 9V Alkaline Batteries (not included)
- H) Offline Voice Control Puck with Wireless Charger
- I) Connecting Strap‡

Headboard Bracket Components (Optional):

- J) Headboard Bracket (2)†
- K) T-Bracket (2)†
- L) Long Bolts (8)†
- M) Short Bolts (6)†
- N) Wingnuts (2)†
- O) Washers (2)†
- P) Hex Key (1)†









Recommended parts not included:





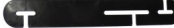

- Q) Surge Protector

* These items are attached to the base for shipping purposes. Carefully remove from base and set aside.

‡ Only included in Twin Long and Cal King Split bases.

† This is an optional item and can be purchased (1-888-550-3746)

A) 	B)* 	C) 
D) 	E) 	F) ‡ 
G) 	H) 	I) ‡ 

HEADBOARD BRACKET COMPONENTS (Optional)			
J)† 	K)† 	L)† 	
M)† 	N)† 	O)† 	P)† 

base and remote overview

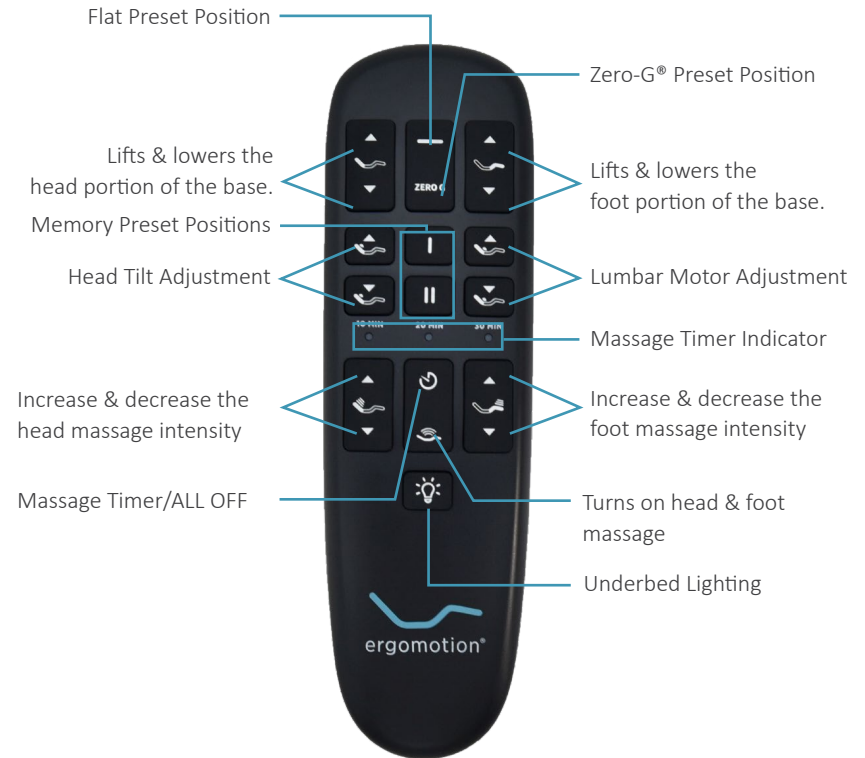
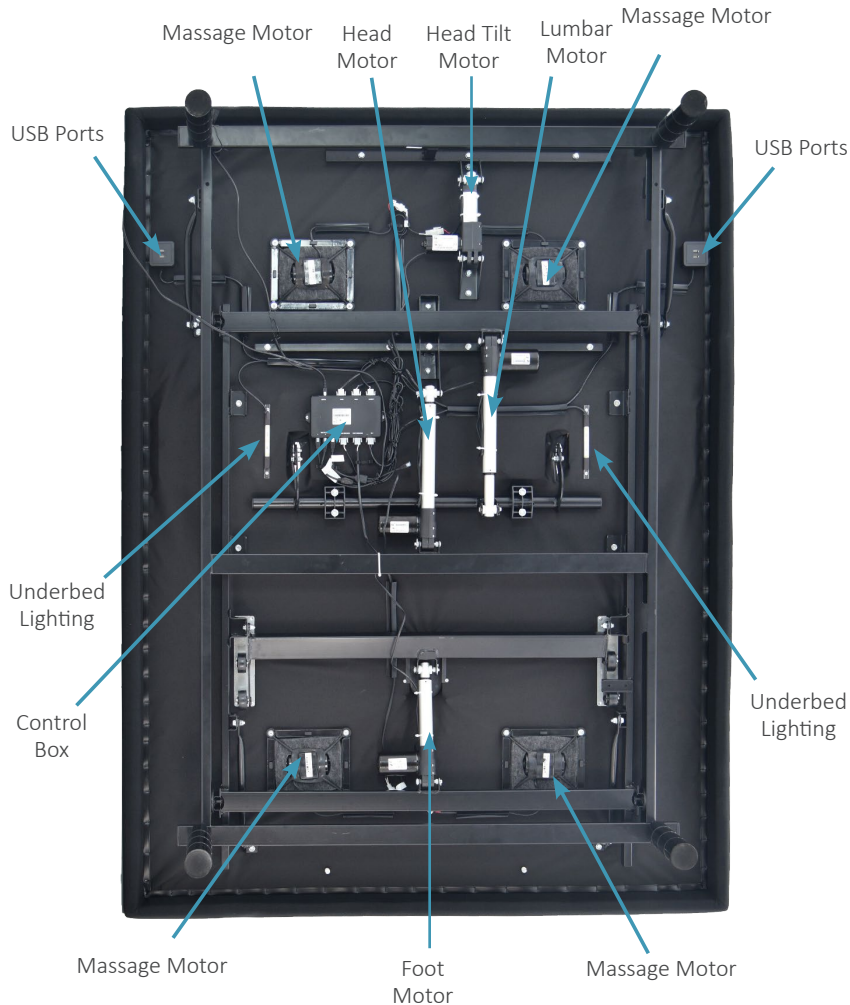

quick reference guide

Not to scale. For illustration purposes only. Read all instructions before beginning installation.

ELECTRONICS OVERVIEW

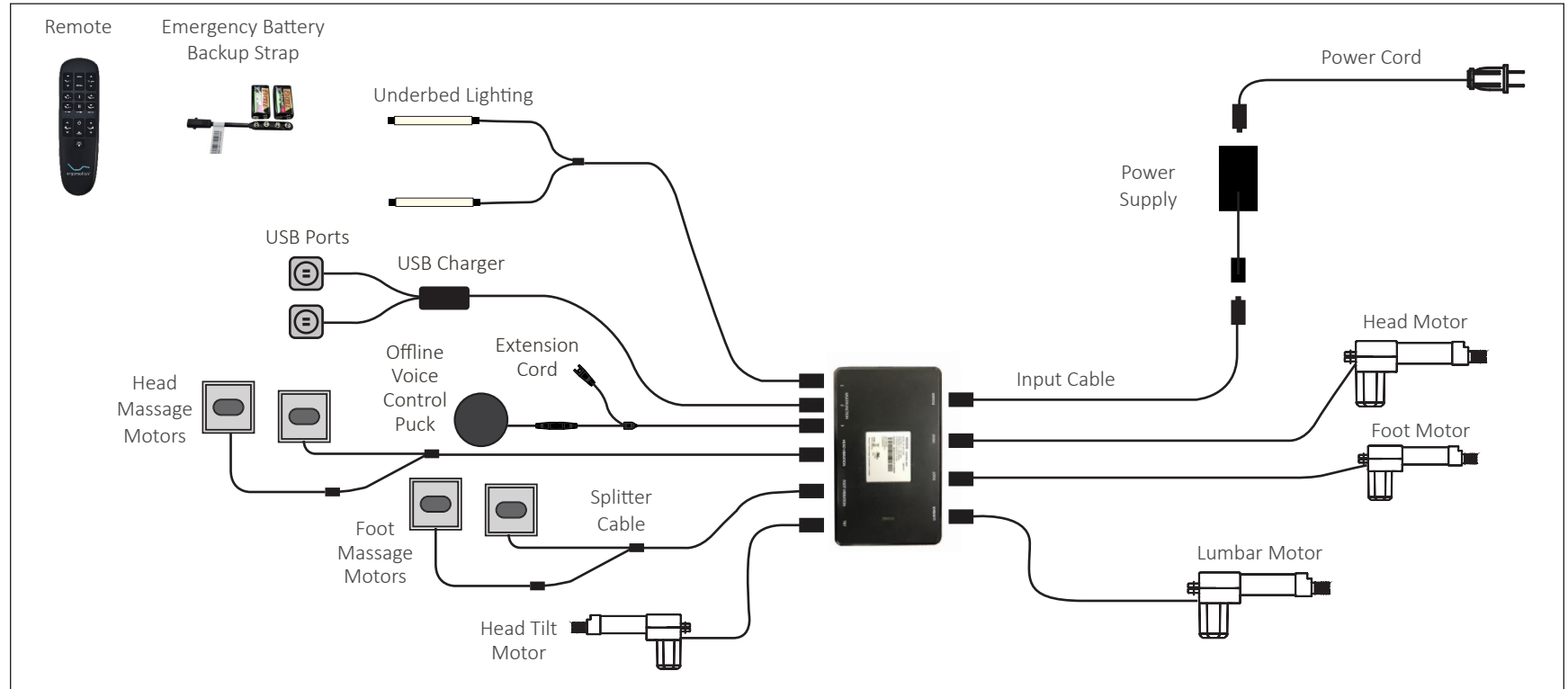

If installing a split unit, see pages 15-16.

installation guide

Always use two people when setting up the base.

1 Remove the bed base from the box keeping the bottom of the base facing upwards.

- Untwist the mattress retainer bar from the frame and set aside.
- Legs are shipped fully assembled. Alternative heights in 3" increments can be achieved by removing leg segments.
- To install the legs, thread the washer over the bolt of the leg with the recessed side facing the leg, and tighten by hand. **Do not over tighten.**



2 Flip the base & connect the cables.

- Uncoil the Input Cord (connected to control box's Power port) and plug it into the Power Supply.
- Carefully flip the base over on to its legs. Important: Two people are required to move the bed base. Do not drag across the floor. Do not rest frame on its side, excessive pressure may damage the legs.
- Insert the Power Cord into the Power Supply.
- Plug the Power Cord into a power outlet. **A surge protector is recommended.**



installation guide

3 Test remote functions & install mattress retainer bar.

- Place each end of the mattress retainer bar into the inserts at the foot of the base until the retainer bar is secured in place.



- Quickly test remote functions to verify proper setup and return the base to a flat position before placing the mattress on top.

4 Setup the Offline Voice Control Puck with Wireless Charger.

- Follow the instructions on the following pages to setup the Offline Voice Control Puck with Wireless Charger device and start controlling your base with voice commands.



offline voice control puck with wireless charger

Setup the puck to enable offline voice control of your adjustable base.

ATTENTION: Your adjustable base can pose an entrapment hazard which is increased in households with small children and or pets. Using voice controls further increases this entrapment hazard due to the potential of unintentionally triggering a command vocally. The voice controls could be unintentionally triggered by yourself, a small child, the television, a radio program, etc. and by using this product you agree that you have read and reviewed the commands, including the Emergency Commands, and acknowledge the increased entrapment risk associated with using voice commands.

If you agree with this statement please read the instructions on the following pages to learn how to setup the Offline Voice Control Puck, however if you have any questions in regard to the use of voice controls please contact customer service prior to activating the Offline Voice Control Puck.

WIRELESS CHARGER

- **Intro:** This item has a wireless charging function. The maximum charging power is 10W. Place the device to be charged in the center of the wireless charger. During normal operation, the green light will indicate that it is charging.
- **Overheat Protection:** In a high temperature environment, when the internal temperature of the product rises to 158 degrees (F), the wireless charger will enter a protection mode and the product will turn off the wireless charging function. When the internal temperature lowers to below 122 degrees (F), the charging function will resume.
- **Incompatible Device Detection:** If an incompatible device is placed on the charger, the red light will indicate that the device should be removed.

OVERVIEW

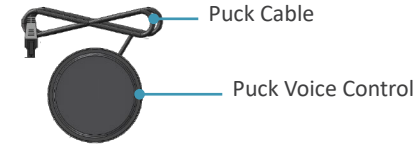

SAFETY INFORMATION

- If you wish to stop using voice commands, you can turn the device off by switching the slider on the back of the Offline Voice Control Puck to the middle “OFF” position.
- Your adjustable base can pose an entrapment hazard and there is an increased risk for households with small children and or pets. Using voice controls increases this entrapment hazard due to the potential of accidentally triggering a command vocally. The voice controls could be unintentionally triggered by a small child, television, radio program, etc., please read the “Emergency Commands” section so that you are familiar with these commands in the event of an emergency.

ENTRAPMENT HAZARD: This bed can crush and kill when it moves. Using voice controls may increase this risk. Review emergency commands before activating voice controls.

	VOICE COMMAND	EXPLANATION
 EMERGENCY COMMANDS	STOP-MOVING	Stop all movement
	ALL-UP	Raise both the head & Foot 6 seconds

offline voice control puck with wireless charger

Follow the installation steps below to setup The Puck device.

Step 1

Please take a minute to familiarize yourself with the voice commands listed on the next page.

Step 2

Remove The Puck from the box.

Step 3

Use the remote control to lift the HEAD to the maximum angle.



Step 4

Locate the connector secured to the corner of the frame and connect it with the Puck Voice Control plug as shown in the picture.



Step 5

The Puck Voice Control will arrive in the Off position and you will need to activate the Puck by selecting an invocation command of your preference.

Use the slider switch on the back side of the Puck to select the invocation phrase you wish to use, either **“HELLO ERGO”** or **“HELLO MOTION”**.

Note: If you have a split base, each side must have a different invocation phrase in order to work independently.



WAKE UP DEVICE

To use the Puck Voice Activated System, simply say the invocation command you chose during setup, either **“HELLO ERGO”** or **“HELLO MOTION”**, and wait 1-2 seconds for the microphone to activate. Once the microphone is activated, indicated by the blue light, it will be active for 8 seconds. While the microphone is active you can now use any of the voice commands listed below to control your adjustable base. If no command is heard within 8 seconds, the Puck will enter “sleep mode” and the microphone will be deactivated.

offline voice control puck voice commands

Once the invocation phrase has been uttered, the microphone will be active for 8 seconds which is indicated by the blue light. While the microphone is active you can now use any of the command utterances listed below to control your adjustable base.

	VOICE COMMAND	EXPLANATION		VOICE COMMAND	EXPLANATION
Common Instructions	GOOD-NIGHT	Flat bed	Message Control	TURN-ON-MASSAGE	Turn on massage driver
	RISE-AND-SHINE	Adjust the bed to the preset position for Zero-G®		TURN-OFF-MASSAGE	Turn off massage driver
	TV-TIME	Adjust the bed to the preset position for watching TV		MASSAGE-UP	Increase the massage strength
				MASSAGE-DOWN	Decrease the massage strength
Actuators Control	RAISE-HEAD	Back actuator rises 3S	Head Massage	TURN-ON-HEAD-MASSAGE	Turn on head massage
	LOWER-HEAD	Back actuator falls 3S		HEAD-MASSAGE-UP	Increase the head massage strength
	RAISE-FOOT	Foot actuator rises 3S		HEAD-MASSAGE DOWN	Decrease the head massage strength
	LOWER-FOOT	Foot actuator falls 3S	Foot Massage	TURN-ON-FOOT-MASSAGE	Turn on foot massage
	RAISE-LUMBAR	Lumbar actuator rises 3S		FOOT-MASSAGE-UP	Increase the foot massage strength
	LOWER-LUMBAR	Lumbar actuator falls 3S		FOOT-MASSAGE-DOWN	Decrease the foot massage strength
	RAISE TILT	Head actuator rises 3S	Massage Mode	WAVE-ONE	Switch to massage mode 1
	LOWER TILT	Head actuator falls 3S		WAVE-TWO	Switch to massage mode 2
WAVE-THREE				Switch to massage mode 3	
Preset	FLAT-PRESET	Flat bed	Save Preset Position	SAVE-LOUNGE	Set the current position to relax mode
	ANTI-SNORE	Adjust the bed to the preset position for anti-snore		SAVE-FAVORITE	Set the current position to favorite mode
	ZERO-G®/ ZERO-GRAVITY	Adjust the bed to the preset position for Zero-G®		SAVE-TV	Set the current position to watching TV mode
	LOUNGE-PRESET	Adjust the bed to the preset position for relax	Underlight Control	TURN-OFF-LIGHT	Turn off underlight
	FAVORITE-PRESET	adjust the bed to the preset position for favorite one		TURN-ON-LIGHT	Turn on underlight
	TV PRESET	Adjust the bed to the preset position for watching TV			

remote control

REMOTE OVERVIEW



ADJUST



The HEAD ▲ ▼ arrows lift and lower the head section of the base.



The FOOT ▲ ▼ arrows lift and lower the foot section of the base.



One touch FLAT preset position.



One touch ZERO-G[®] preset position. Zero-G[®] adjusts your legs to a higher level than your heart helping to relieve pressure off the lower back and promote circulation.

remote control



MOTOR FUNCTIONS



The HEAD TILT ▲ ▼ arrows will adjust the level of head support.



The LUMBAR ▲ ▼ arrows will adjust the level of lumbar support.



MEMORY PRESETS



Preset Position #1



Preset Position #2

TO PROGRAM THE PRESET POSITIONS:

Articulate the head and foot to your desired position. Next, press and hold one of the preset buttons [I, II] for 5 seconds. The position is now saved.

NOTE: To restore the preset buttons back to their original factory settings, hold **FLAT** and **ZERO-G®** simultaneously for at least 5 seconds. The original presets will be restored.

MESSAGE FUNCTIONS / LIGHTING



The HEAD MASSAGE button will turn on the head massage. Cycle through 3 massage intensities.



The FOOT MASSAGE button will turn on the foot massage. Cycle through 3 massage intensities.



The TIMER/ALL OFF button starts massage at level 2. Select a 10, 20 or 30 minute message interval. Pressing a fourth time will turn off massage.



The lights on the top of the remote indicate a 10, 20 or 30 minute timer setting. Massage will automatically shut off after 10 minutes if the massage timer isn't set.



The MASSAGE button turns on the head and foot massage.



Press once to activate Underbed Lighting. Press again to turn off.

pairing remote control

The original remote that comes in the box is already paired to the adjustable base. No further action is required. In the event that the remote is not paired with the base, follow the steps below.

1

Unplug the Power Cord from your power outlet. Wait 1 minute, then plug it back in to your power outlet. Perform Step 2 within 10 seconds, while the control box light is flashing.

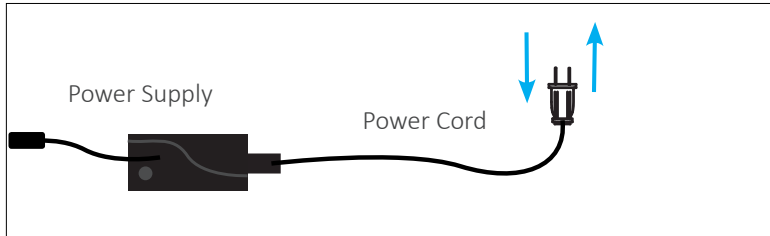

3

Test all remote functions. If the remote buttons do not impact the adjustable base movements, please repeat the process again or call Ergomotion customer service.

2

Press and hold down the **Head Up** and **Foot Down** buttons simultaneously. The LED light on the remote will start flashing. When the LED stops flashing, the illuminated light on the Control Box will go out. Release the **Head Up** and **Foot Down** buttons. The remote is now paired to the adjustable base.



connecting strap

If a split setup is being installed, a plastic connecting straps can be used to help secure the bases together. A connecting strap is included with Twin Long and Cal King Split bases.

1

With the bases in their desired location, slightly loosen both legs to allow the strap to fit on the leg bolt, between the leg washer and frame.



3

Re-tighten legs. Do not over tighten. Use the remaining strap and repeat on other end of the base.

2

Slide side (a) of the connecting strap onto leg bolt. Swing the strap and connect side (b) to the leg bolt. Secure the strap by shifting to the left.



syncing two bases (optional)

A Sync Cord is included with the base. Not available on Queen, Full or Full-Long size bases.

The Sync Cord connects the two control boxes to a single remote for the synchronization of two bases.

This process is most commonly used for syncing two connected TXL bases.

- 1 Unplug bases from power source.
- 2 Connect the Sync Cord to the Multifunction port of each Control Box.
- 3 Plug bases back into the power source.
- 4 Check to ensure all cords are securely attached. Both remotes will now operate both bases simultaneously.

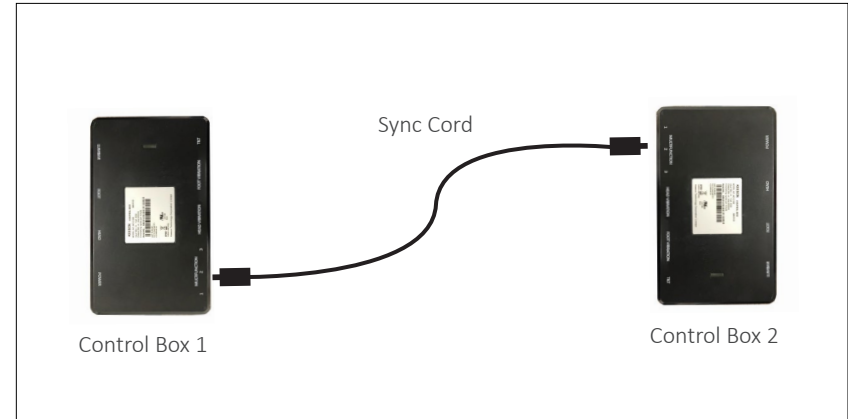

PERFORMANCE NOTES

If bases become mismatched, returning the bases to the flat positions will re-sync the mechanical positions.

The system is now linked. Pressed buttons on either remote will control the two bases simultaneously.

headboard bracket installation guide (optional)

Headboard Brackets are an optional accessory.

A hex key is included with the accessory kit to complete installation.

1

- a. Align the hole in the bracket to the brass sleeve into which the leg threads. Hold the bracket in place and screw the leg into the base until it is snug. **DO NOT OVERTIGHTEN.** Too much force may cause the leg to spin freely.
- b. Align the tab with the hole in the frame (located towards the foot of the base) and use a short bolt, washer and wingnut to secure the bracket. Make sure the bolt is tight.



2

- a. Measure the distance between the mounting holes on the headboard and install the T-Bracket to accommodate the headboard.
- b. To install the T-Bracket, slide the T-Bracket through the end of the headboard bracket. Align the flat side of the T-Bracket plate to the mounting holes on the headboard.
- c. Secure T-Bracket in place by inserting two short screws through top of bracket. Use hex key to tighten screws.

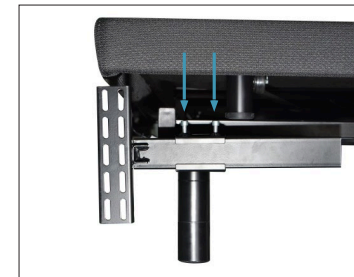

3

Connect your headboard to the attachment plate using the remaining long screws or hardware that came with your headboard. The heads of the bolts will face outward. Use hex key to tighten bolts.

battery backup strap (optional)

For emergency use only, in case of a power outage.
Batteries are not to be used for normal operation of the bed.

- 1 Disconnect the Power Supply from the input power cord.

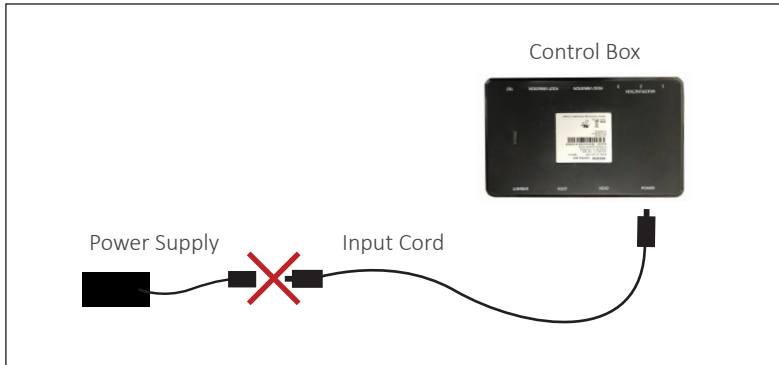

- 3 Connect the end of the Battery Backup Strap to the input power cord that is attached to the control box.

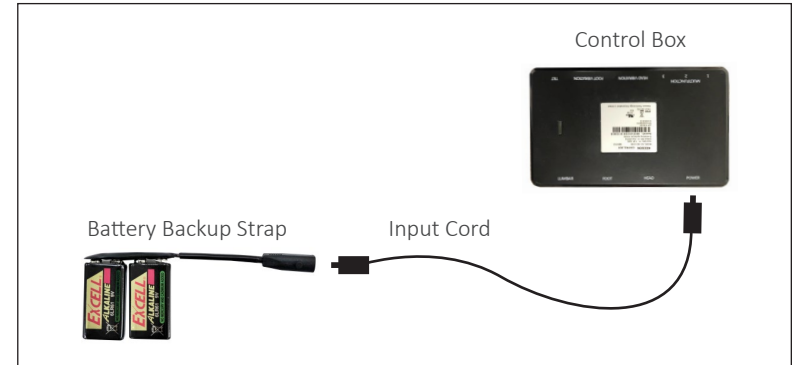

- 2 Connect the Battery Backup Strap to the (2) Alkaline 9 Volt batteries. Do not mix brand name Batteries.



- 4 Use the remote to return the base to a flat position.

Note: Detach the Battery Backup Strap and reconnect the power supply after the emergency is over, as the system will continue to draw power from the batteries even if not in use.

If one or more functions on the bed base have stopped operating:

- Check under the bed base to verify that the wired connections are secure and that there are no cords or bedding obstructing the movement of the base.
- Check to ensure the green LED light is illuminated on the power supply. If there is no light, verify that the input and power cords are properly connected.
- Unplug the base for 1 minute to reset the electronic components.
- Plug bed base into a different electrical outlet, or test current outlet with another working appliance (a grounded, electrical surge protector is recommended).

If issue is not resolved by following the instructions above,
locate serial number on warranty card or back of remote and call customer service.

10 year limited warranty

Register online: <https://warranty.ergomotion.com/warranty>

Please prepare a digital copy of your proof of purchase (invoice or sales receipt) when registering online.

2-Year Hassle Free Warranty

Your adjustable base is warranted by the manufacturer against defects in materials or workmanship for a period of two years from the date of delivery to the original Purchaser. During such time, the manufacturer will repair or replace, at no cost to the original Purchaser, any warranted part(s)* found to be defective by the manufacturer, in its sole discretion. This includes all pre-authorized labor and transportation costs incurred with the repair or replacement of any part found to be defective.

5-Year Warranty on Parts

During year 3 through 5 from the original delivery date, the manufacturer will replace any part on the adjustable base found to be defective by the manufacturer, to the original Purchaser. The manufacturer's liability is limited to the replacement of the defective electrical/mechanical part(s)* ONLY, with the Purchaser responsible for all service, installation, and transportation cost of said part(s).

10-Year Limited Warranty

Notwithstanding the above, the manufacturer extends a 10-year warranty on mechanical base parts found to be defective on a limited basis as defined herein. Specifically, the manufacturer warrants that for a full 10 years from the commencement date of this warranty, any defect in the workmanship or the materials used shall be covered. For purposes of this 10-year warranty, it specifically excludes the cover, shroud, platform, legs, actuator lift motors, massage motors, control box, remote controls, power supply, and all power supply cords. The purchaser shall pay 1/5 of the current MSRP of the replacement part, or the entire adjustable base if deemed irreparable at the sole discretion of the manufacturer, multiplied by the number of years after the fifth year from the original delivery date. The manufacturer's liability shall

be limited to the replacement of the defective part(s) ONLY with the purchaser responsible for all service, installation and freight costs for said part.

Additional Terms & Conditions

This warranty does not include reimbursement/replacement for inconvenience, removal, part(s) installation, bed set up, loss of use, normal wear and tear, shipping or any other costs or expenses not expressly covered in this warranty. In addition, this warranty shall be void in the following circumstances:

- A. Damage resulting from misuse or abuse caused by the Purchaser or any third party.
- B. Damage caused by repairs or parts replacement by an unauthorized person.
- C. Damage caused if the adjustable base has been mishandled (including during shipping), subject to physical abuse or an improper power supply, or by failing to adhere to the Owner's Manual and this warranty.
- D. Damaged mattresses, foundation cover(s), fabric(s), bedding cables, electrical cords or accessories supplied by dealers or any third party. Contact your dealer for warranty information on these items.
- E. Modification of the adjustable base without prior written consent by the manufacturer.
- F. Costs for unauthorized service calls for the purpose of educating the consumer about the adjustable base or locating proper functioning power outlets.
- G. Damage if the recommended weight restrictions are exceeded.
- H. Damage if used in any environment or a commercial setting which was not intended.

10 year limited warranty

- I. This warranty requires notice to be given to Ergomotion of any claim for repairs or replacement parts.
- J. Damage to foam shroud by improper handling or misuse.

*Parts include the following:

- a. Head/Foot Actuator
- b. Massage Motors and Housing
- c. Control Box
- d. Remote Control
- e. Power Cord, Power Supply, and Input Cord
- f. Mounting Brackets
- g. Support Struts

OTHER THAN AS EXPRESSLY SET OUT HEREIN, AND TO THE EXTENT PERMITTED BY APPLICABLE LAW, THIS WARRANTY IS EXCLUSIVE AND IN LIEU OF ALL OTHER ORAL OR WRITTEN WARRANTIES, REPRESENTATIONS, CONDITIONS OR PROMISES, WHETHER EXPRESS OR IMPLIED, AND WHETHER ARISING BY LAW, STATUTE, COURSE OF DEALING OR USAGE OF TRADE, INCLUDING, BUT NOT LIMITED TO, IMPLIED WARRANTIES AND CONDITIONS OF MERCHANTABILITY, QUALITY, DURABILITY AND/OR FITNESS FOR A PARTICULAR PURPOSE. TO THE EXTENT PERMITTED BY APPLICABLE LAWS, ANY IMPLIED WARRANTIES (IF APPLICABLE) ARE LIMITED IN DURATION TO THE DURATION OF THIS WARRANTY. TO THE EXTENT PERMITTED BY APPLICABLE LAW, IN NO EVENT SHALL THE MANUFACTURER BE LIABLE FOR ANY SPECIAL, INCIDENTAL, PUNITIVE, EXEMPLARY, CONSEQUENTIAL, LIQUIDATED OR SIMILAR DAMAGES, WHETHER OR NOT FORESEEABLE.

Note: The exclusion directly above is inapplicable to consumers residing in Québec.

To the extent permitted by law, this warranty is not transferable and will automatically terminate if the original Purchaser sells or otherwise disposes of

the adjustable base.

This warranty gives the Purchaser specific legal rights. Other rights, which vary from jurisdiction to jurisdiction, may exist. In addition, some jurisdictions do not allow (i) the exclusion of certain warranties, (ii) limitations on how long an implied warranty lasts and/or (iii) the exclusion or limitation of certain types of costs and/or damages, so the above limitations may not apply.

This warranty is only valid in The United States, Canada and Puerto Rico. For all other jurisdictions, this Limited Product Warranty is valid only in the jurisdictions where the Products are sold by an Ergomotion authorized reseller or agent and is valid to the extent permitted by the applicable laws of such jurisdictions.

Weight Limits

This product is not rated to support weights exceeding 750 pounds (340kg). This product is not rated to support weights in excess of 750 pounds inclusive of the mattress and bedding. The base will structurally support this weight, provided it is evenly distributed across the bed base. The adjustable base is not designed to support or lift this amount in the head or foot sections alone. Exceeding this weight restriction could damage the bed and/or cause injury and will void the warranty.

Phone 1.888.550.3746
Fax 1.805.979.9399
Email info@ergomotion.com
Web www.ergomotion.com

Serial Number:

+ +
+ +