

# BATTERY MONITOR

## GP-BMK-25 User Manual

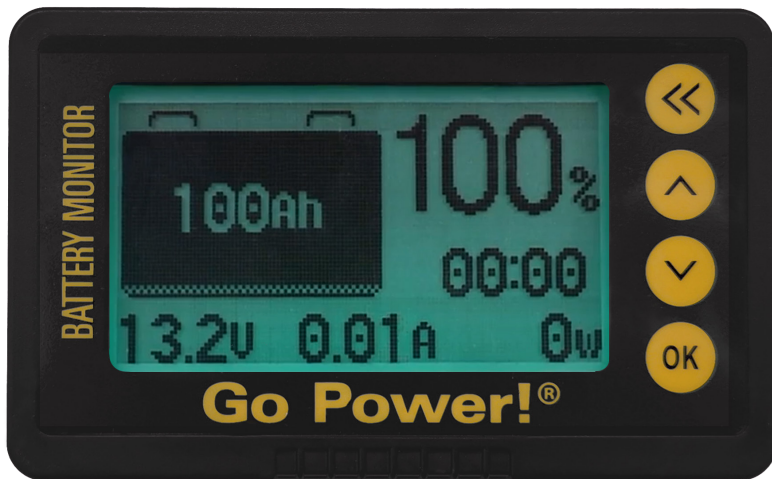

© 2022 Go Power!

Worldwide Technical Support and Product Information [gpelectric.com](http://gpelectric.com)

Go Power! | Dometic

201-710 Redbrick Street Victoria, BC, V8T 5J3

Tel: 1.866.247.6527

MAN\_GP-BMK-25\_RevB





2.	INTERFACE.....	5
3.	OPERATION.....	6
	3.1 SETTINGS MENU .....	6
	3.2 SLEEP/WAKE UP .....	8
	3.3 SPECIFICATIONS .....	8
	3.4 LCD BACKLIGHT BRIGHTNESS ADJUST .....	9
4.	INSTALLATION .....	9
	4.1 WIRING DIAGRAM.....	9
	4.2 WIRE CONNECTIONS .....	10
	4.3 MOUNTING THE REMOTE DISPLAY.....	10
	4.3 MOUNTING THE SHUNT.....	10
5.	DIMENSIONS .....	11
6.	TROUBLESHOOTING .....	12
7.	WARRANTY.....	13
	5.1 WARRANTY LENGTH.....	13
	5.2 WARRANTY RETURN PROCEDURE .....	13
8.	TEMPLATE .....	14

---

## SAFETY PRECAUTIONS

---



**WARNING!**  
Personal Injury

---

Working in the vicinity of a lead acid battery is dangerous. Batteries can generate explosive gases during operation. Never smoke or allow a spark or flame in the vicinity of a battery. Provide sufficient ventilation around the battery.

---

Wear eye and clothing protection. Avoid touching eyes while working near batteries. Wash your hands when done.

---

If battery acid contacts skin or clothing, wash them immediately with soap and water. If acid enters an eye, immediately flood the eye with running cold water for at least 15 minutes and get medical attention immediately.

---

Be careful when using metal tools in the vicinity of batteries. Dropping a metal tool onto a battery might cause a short circuit and possibly an explosion.

---

Ensure that children, pets, and other animals are kept away from the inverter, solar arrays, battery bank, and utility grid components.

---

Remove personal metal items such as rings, bracelets, necklaces, and watches when working with a battery. A battery can produce a short circuit current high enough to melt objects such as rings, causing severe burns.

---

## 2. INTERFACE

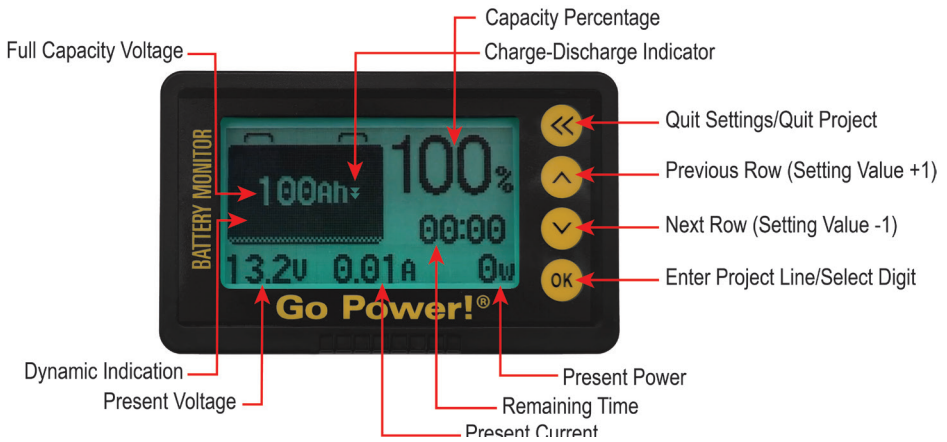

### SETTINGS MENU

Using the Next and Previous Row arrows, you can move up or down through the LCD options.

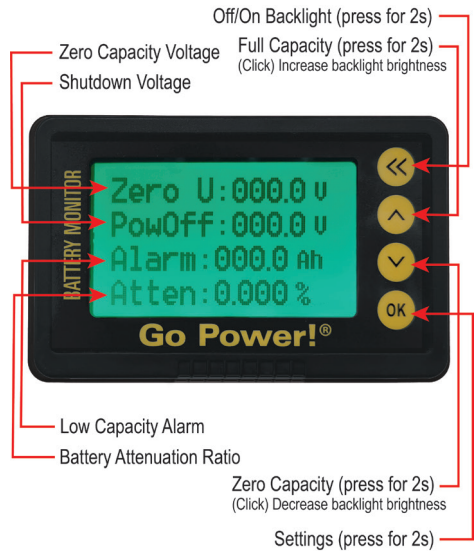
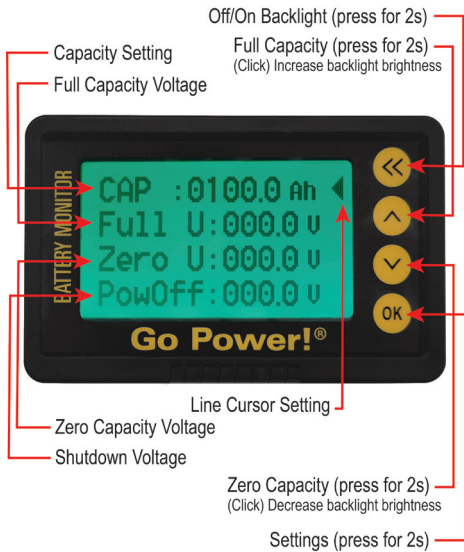

### 3.1 SETTINGS MENU

#### DEFINITIONS:

**CAP** - Effective capacity of battery: the initial capacity from the factory. Please set according to the actual effective capacity of the battery bank to view the accurate capacity percentage

**FULL V**- Full capacity voltage: the capacity value is automatically set to 100% after the voltage is exceeded (Filled up).

**Zero V** - Zero capacity voltage: The capacity value is automatically set to 0% if below this voltage. The voltage value will flash and the buzzer will alarm once per 10s if the discharge continues (Zero clearing)

**PowOFF** - Shutdown voltage: Backlight and LCD off and no display if below this capacity

**Alarm** - Low capacity alarm: The percentage and battery symbol will flash and the buzzer will sound per 10s if below this capacity.

**Atten** - Battery attenuation ratio: After the battery capacity cumulatively once per cycle, the capacity value is automatically changed according to this ratio.

#### NOTE

Do not set Full V and Zero V without understanding the voltage characteristics of the battery bank (full voltage and vent voltage). The factory default of Full V and Zero V is 0V, which is invalid.

#### USING THE SETTINGS MENU:

1 Press the  key for 3s to enter setting menu;

2. Click  or  key to select the setting items.

#### INITIAL SET UP:

Calibration is required when the GP-BMK-25 is connected for the first time, or your battery bank is being replaced.

If you are starting with a full battery, on the main screen hold the  key for 3s to set the capacity to 100%.

If you are starting with an empty battery, hold the  key for 3s while on the main screen to set the capacity to 0%.

# OPERATION

## SETTING THE BATTERY CAPACITY:

Select CAP and click the  key to enter the pre-set capacity setting;

The set value will flicker, clicking the  key can select other values.

Click the  or  key to select the correct values.

After this click the  key to quit pre-set capacity setting

## SETTING VOLTAGE PARAMETERS:

The "FULL V" and "ZERO V" parameters in the settings screen are for automatic state of charge synchronization. If the battery voltage is above "FULL V" the state of charge will reset to 100% and if it falls below "ZERO V" the state of charge will reset to 0%. Setting either of these values to zero will disable this function.

### NOTE

If the battery is going to be heavily discharged then use 0 for ZERO V, which would disable the low voltage reset.

The following table contains suggested voltages for common battery types.

	High Voltage	Low Voltage
Gel	14.1	9
Flooded	14.4	9
AGM	14.4	9
LiFePO4	14.2	9

### NOTE

These are suggested values only and may not work for all applications. Confirm with your battery manual for the accurate voltage parameter information.



**SETTING LOW CAPACITY ALARM:**

This is the lower battery capacity limit in ampere-hours. If the battery is discharged below this limit and audible alarm will sound. Setting this value to zero will disable this function.

**3.2 SLEEP/WAKE-UP**

The GP-BMK-25 will go into a sleep mode if the battery current drops below a certain level. To “wake” the GP-BMK-25 from this mode, press any key. The GP-BMK-25 screen will automatically wake once the battery starts charging or discharging **TURN OFF BACKLIGHT**

While charging the battery, the LCD screen's backlight will slowly flash.

To turn off the backlight, long press  to turn off the backlight, long press  again to wake up the backlight.

**3.3 SPECIFICATIONS**





<b>DESCRIPTION</b>	<b>PARAMETER</b>
Working Voltage	10.0 - 12.0 V
Voltage Accuracy	± 1.0 %
Current Accuracy	± 1.0 %
Capacity Accuracy	± 1.0 %
Backlight on Current (> 50A)	100 mA
Present Capacity Value	0.1 - 9999.0 Ah
Temperature Range	-10 - 60 °C (14 - 140 °F)
Weight (LCD Interface)	2.6 oz / 75 g
Size (LCD Interface)	3.9 x 2.4 x 0.7 inch (9.9 x 6.1 x 1.8 cm)
Shielded Wire	20 ft (6 m)
B+ Wire	3 ft (1 m)



## 4. INSTALLATION

### 3.4 LCD BACKLIGHT BRIGHTNESS ADJUST

To adjust the brightness of the backlight,

1. Press and hold the  button to turn off the backlight (the backlight will not light up during work).
2. Press and hold the  button again to turn on the backlight (the backlight will flash during charge and the backlight will light up during discharge).
3. Click  or  button to increase or decrease backlight brightness.



## 4. INSTALLATION

### 4.1 WIRING DIAGRAM

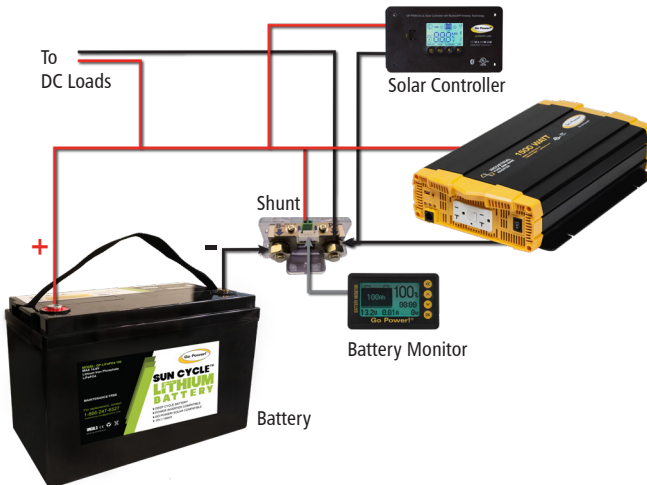

#### NOTE

Please connect as shown with all loads and charging sources connected to the "P-" side of the shunt. The shunt must be connected to the negative circuit. DO NOT connect to the positive circuit.

## 4.2 WIRE CONNECTIONS

1. Before doing anything, disconnect all wires from the negative side of the battery.
2. Cut the negative cable for the battery and crimp on new ring terminals. Alternatively, use a new wire of appropriate gauge to carry the full current demand of the system.
3. Connect the shunt as shown in the wiring diagram above.

The negative terminal of the battery must connect directly to the "B-" side of the shunt and there should be no other connections to the negative terminal of the battery.

**NOTE**

4. Using the red wire, connect the ring terminal end of the wire to positive of battery. The other end connects to B+ of Shunt.

Do not stack smaller terminals under large ones.

**NOTE**

5. Connect the Shunt to the GP-BMK-25 using the shielded wire to test. If done correctly the display will turn on. Disconnect again so remote display can be mounted.

## 4.3 MOUNTING THE REMOTE DISPLAY

The remote display can be mounted by following these steps.

1. Plan the location of your remote display carefully. Keeping in mind the cable needs to be run from the shunt to the monitor.
2. Use the installation template on the last page of this manual to cut a hole.
  - The remote display uses clips to stay in place so the hole size needs to be as accurate as possible.
  - Using a jigsaw is recommended.
3. Run the shielded cable from your battery bay and feed it through the cut hole.
4. Connect the shielded cable to the remote and snap the remote into place.

## 4.4 MOUNTING THE SHUNT

The shunt comes with a mounting bracket that should be secured using screws to ensure the shunt does not move.

# 5. DIMENSIONS

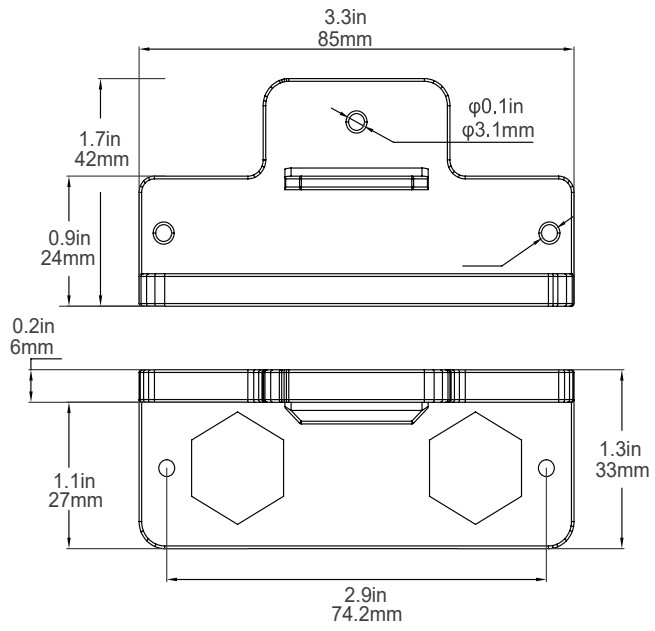
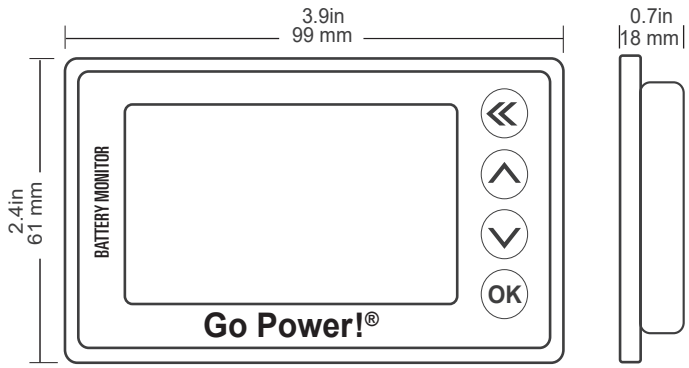

**Issue: Backlight is blinking when connecting the load for the first time**

Remedy: the B- and P- wires on the shunt are wired backwards.

**Issue: BMK-25 screen is blank**

Remedy #1: When the battery current is low the GP-BMK-25 will enter a low power (sleep mode) and the backlight will turn off, press any button and the backlight will turn on for 10s.

Remedy #2: Check the connection if the screen does not respond. Then charge or discharge the battery and check whether the display current is equal to the actual current. If the deviation is large, please check the connection.

**Issue: The GP-BMK-25 State of Charge is inaccurate or resets to zero or 100% unexpectedly.**

Remedy #1: It could be that the way your battery is being used is causing the state of charge to reset prematurely. For more accurate SOC, complete the following steps:

1. The High V and Low V should both be set to zero
2. Turn all loads off
3. Turn battery charger on
4. Wait for voltage to be 14.1 (Gel) / 14.4 (Flooded or AGM) / 14.2 (LiFePO4) and current into battery to be 1.5% - 2% of Ah capacity of the battery
5. Hold up arrow on BMK to reset SOC to 100%

This manually synchronizes the SOC of the GP-BMK-25 with the SOC of the battery, and can be done as often as is desired.

Remedy #2: Check that the shunt is wired in the correct orientation according to the wiring diagram in section 3.5 of this manual.

## 7. WARRANTY



### 7.1 WARRANTY LENGTH

Go Power! electronic products are non-repairable, Go Power! does not perform repairs on its products nor does it contract out those repairs to a third party. Go Power! does not supply schematics or replacement parts for any of its electronic products.

This Go Power! warranty is valid against defects in materials and workmanship for the specific product warranty period. It is not valid against defects resulting from, but not limited to:

Misuse and/or abuse, neglect or accident

Exceeding the unit's design limits

Improper installation, including, but not limited to, improper environmental protection and improper hook-up

Acts of God, including lightning, floods, earthquakes, fire, and high winds

Damage in handling, including damage encountered during shipment

A warranty shall be considered void if the warranted product is in any way opened or altered. The warranty will be void if any eyelet, rivets, or other fasteners used to seal the unit are removed or altered, or if the unit's serial number is in any way removed, altered, replaced, defaced, or rendered illegible.

### 7.2 WARRANTY RETURN PROCEDURE

Before contacting Go Power!'s customer service department, please read the "frequently asked questions" section of our website to troubleshoot the problem. If trouble persists:

Call your Go Power!™ Technical Support team (1-866-247-6527) or

Return defective product to place of purchase

An RMA number (Return Materials Authorization number) from Go Power! Customer Service is required prior to returning any Go Power!. Go Power! reserves the right to refuse any items sent to Go Power! without an associated RMA number.

To obtain an RMA number, please contact [techsupport@gpelectric.com](mailto:techsupport@gpelectric.com) or Telephone 1-866-247-6527 or Fax 1-866-607-6527 worldwide.

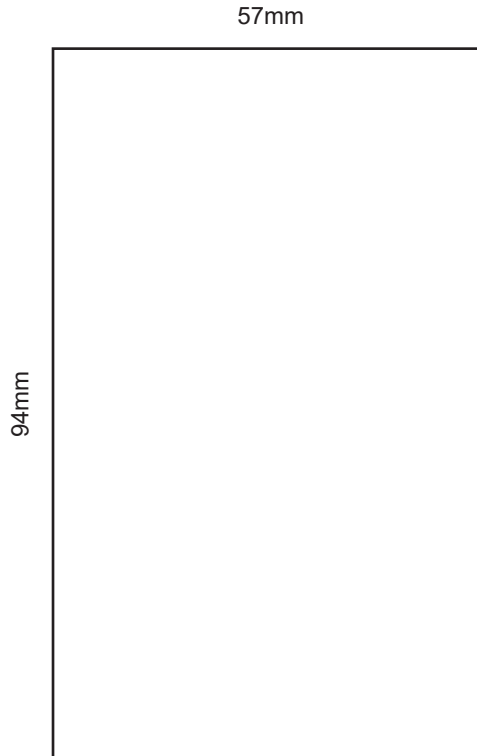

© 2022 Go Power!

Worldwide Technical Support and Product Information [gpelectric.com](http://gpelectric.com)

Go Power! | Dometic

201-710 Redbrick Street Victoria, BC, V8T 5J3

Tel: 1.866.247.6527

MAN\_GP-BMK-25\_RevB