

# RV-C REMOTE DISPLAY

## User Manual

GP-RVC-R



© 2022 Go Power!

Worldwide Technical Support and Product Information [gpelectric.com](http://gpelectric.com)

Go Power! | Dometic

201-710 Redbrick Street Victoria, BC, V8T 5J3

Tel: 1.866.247.6527

GP-RVC-R Manual\_RevB



Congratulations on purchasing your Go Power! RVC Remote. This remote is compatible with the GP-RVC-30-MPPT and GP-RVC-10-MPPT Solar Controllers

Record the unit's model and serial number below. It is much easier and quicker to record this information now at the pre-installation stage.

Model Number:
Serial Number:
Date of Install:
Battery Bank Information: (size, install date, battery type)



### Product Packaging

Please safely store the packing the IC Series was delivered in or recycle the packaging components as outlined below:



Corrugated fiberboard  
main box

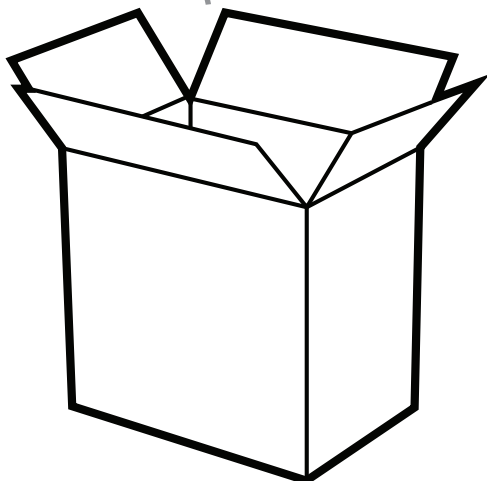

Plastic  
foam protection

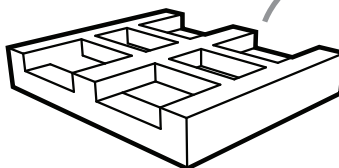

LDPE  
Low Density  
Polyethylene



Plastic  
accessories bag

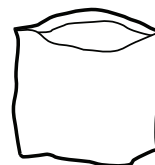

Local recycling centers can be found here:  
[www.earth911.com/recycling-center-search-guides](http://www.earth911.com/recycling-center-search-guides)



# CONTENTS

---

1.	SAFETY.....	4
2.	APPEARANCE.....	5
3.	USER INTERFACES.....	6
4.	STATUS, SETTINGS AND COMMANDS.....	9
5.	CHARGE STATES & FAULTS.....	12
6.	COMMANDS.....	13
7.	PARALLEL CONTROLLER STATUS.....	13
8.	INSTALLATION.....	18
9.	BLUETOOTH WIRELESS TECHNOLOGY.....	19
10.	LIMITED WARRANTY.....	21
11.	MOUNTING TEMPLATE.....	23

Important safety information is contained throughout this manual that should be carefully observed and followed. This information is presented using the following format:

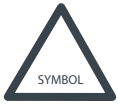

**Warning / Caution:** Result  
Description of condition leading to result

The Information is categorized in two ways:

**Warning:** Bodily harm could occur if instructions are not explicitly followed. If there are any doubts about the procedure or conditions, please call GoPower! technical support before doing anything.

**Caution:** Damage to property could occur if instructions are not followed properly.

The following symbols are used to indicate the type of hazard.

SYMBOL	MEANING	SYMBOL	MEANING
	General Warning		Hot Surface
	Risk of Shock		Risk of Fire
	Risk of Electrocution		Risk of Chemicals
	Risk of Explosion		Risk of Eye Injury



**DISCONNECT ALL POWER SOURCES**

Electricity can be very dangerous. Installation should be performed only by a licensed electrician or qualified personnel.



**BATTERY AND WIRING SAFETY**

Observe all safety precautions of the battery manufacturer when handling or working around batteries. When charging, batteries produce hydrogen gas, which is highly explosive.



**WIRING CONNECTIONS**

Ensure all connections are tight and secure. Loose connections may generate sparks and heat. Be sure to check connections one week after installation to ensure they are still tight.



**WORK PLACE SAFETY**

Wear protective eyewear and appropriate clothing during installation. Use extreme caution when working with electricity and when handling and working around batteries.

## 2. APPEARANCE



NO.	NAME
1	LCD Screen
2	Up Button
3	Down Button
4	Enter Button
5	Back Button
6	RJ12 Connector

#### STARTUP SPLASH SCREENS

The following splash screens are displayed when the controller/remote display are first powered on.

[MENU 1]: RVC-DISPLAY Establishing connection with the controller (this interface only exists for a very short time)

[MENU 2]: RVC-DISPLAY startup, displays Go Power!

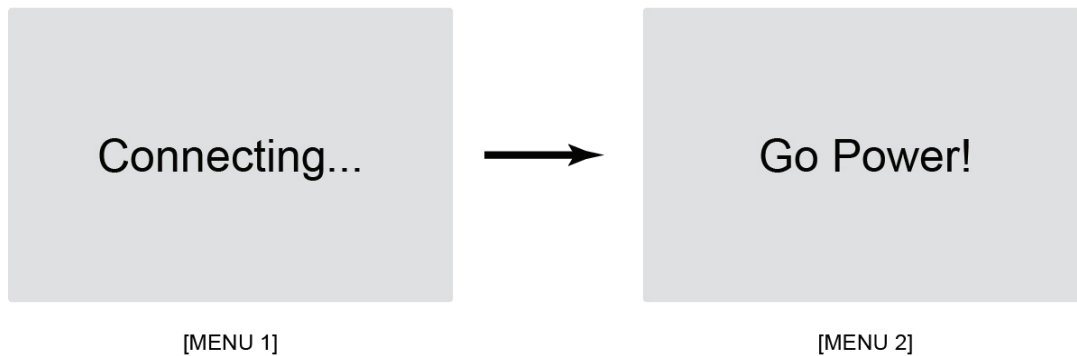

#### 1. Main Screen

Displays PV Voltage, Current, BAT1 and BAT2's Voltage and Current, Solar Controller Internal Temperature, Solar Controller Charge State / Fault, and Bluetooth Connection Status. Section 5 provides additional detail of the Solar Controller Charge State / Fault display.

Solar	<b>0.0V</b>	<b>0.0A</b>
BAT1	<b>12.2V</b>	<b>0.0A</b>
BAT2	<b>10.5V</b>	<b>0.0A</b>
25°C	Error: BAT2:UVP	

[MENU 3] - 30A

Solar	<b>0.0V</b>	<b>0.0A</b>
BAT	<b>10.5V</b>	<b>0.0A</b>
25°C	Error: BAT2:UVP	

[MENU 3] - 10A

#### 2. Status Screens

The status screens show detailed status information that is not on the main screen. The following steps can be used to get to the status screens shown as [MENU4] to [MENU8] and navigate through them. A detailed explanation of each status parameter is included in a table in section 4 below.

Short press [ENTER] button go to status interface

Short press [BACK] button to quit status interface and go to main interface

Short press [DOWN] button: the menu's sequence is [MENU4]->[MENU5]->...->[MENU8]->[MENU4]

Short press [UP] button: the menu's sequence is [MENU8]->[MENU7]->...->[MENU4]->[MENU8]

**Note** 10A controllers do not have BAT2 parameters

**Note** Each time the [DOWN] [UP] buttons are pressed, it will enter next interface

# USER INTERFACE

Device Status	
PV Voltage:	0.0V
PV Current:	0.00A
Batt1 Chg Sta:	IDLE
Batt1 Voltage:	13.3V
Batt2 Voltage:	0.0V

[MENU 4]

Device Status	
Chg Current:	0.00A
Battery Temp	25C
Device Temp	24C
Fault	Bat2_NC
Run Time	2Day

[MENU 5]

Device Status	
Total WH:	0WH
Total AH:	0AH
Ah Today	0AH
Ah 1Day ago:	0AH
Ah 2Days ago:	0AH

[MENU 6]

Device Status	
Ah 3Days ago:	0AH
Solar Rated V:	24V
Batt Rated V:	24V
Batt Rated I:	30A
FW Ver:	1.10

[MENU 7]

Device Status	
HW Ver:	1.00
Name:	GP-RVC-30
SN Num:	000000000
Type:	2

[MENU 8]

### 3. Setting Screens

The settings screens are used to view and edit settings and also to issue commands to the controller. The following steps can be used to get to the settings screens shown as [MENU9] to [MENU16] and navigate through them. A detailed explanation of each setting parameter is included in a table in section 4 below.

Long press [ENTER] button go to system setting interface

Short press [BACK] button quit setting interface and go to main interface

Short Press [DOWN] button to move down by one setting (the curser wraps back to top when you reach the bottom)

Short press [UP] button to move up by one setting (the curser wraps back to bottom when you reach the top)

Press [ENTER] on a setting to edit and use [DOWN] and [UP] to change value. [ENTER] locks setting in and [BACK] cancels setting.

**Note** 10A controllers do not have BAT2 parameters

**Note** Each time the [DOWN] [UP] buttons are pressed, it will enter next interface

**Note** The small black triangle before the parameter item indicates the currently selected item

**Note** When the user sets the parameter, the value of the parameter item will flash, and the user can change the setting.



The following steps can be used to get to the settings screens shown as [MENU9] to [MENU16] and navigate through them."

System Settings	
▶ Batt1 I Limit:	30A
Batt1 Type:	GEL
Batt1 Nom V:	AUTO
Batt1 Ah:	200AH
Batt1 OVP:	16.0V

[MENU 9]

System Settings	
▶ Batt1 Eq V:	14.1V
Batt1 Bulk V:	14.1V
Batt1 Float V:	13.7V
Batt1 Chg Rtn:	13.2V
Batt1 LRV:	12.8V

[MENU 10]

System Settings	
▶ Batt1 Warn V:	12.0V
Batt1 ODV:	11.0V
Batt1 ODVD:	10S
Batt1 Eq Time:	0M
Batt1 BST Time:	120M

[MENU 11]

System Settings	
▶ Batt1 Equ Int:	0D
Batt1 Comp:	-24
Batt2 I Limit:	30A
Batt2 Type:	GEL
Batt2 Nom V:	AUTO

[MENU 12]

System Settings	
▶ Batt2 Ah:	200AH
Batt2 OVP:	16.0V
Batt2 Eq V:	14.1V
Batt2 Bulk V:	14.1V
Batt2 Float V:	13.7V

[MENU 13]

System Settings	
▶ Batt2 Chg Rtn:	13.2V
Batt2 LRV:	12.8V
Batt2 Warn V:	12.0V
Batt2 ODV:	11.0V
Batt2 ODVD:	10S

[MENU 14]

System Settings	
▶ Batt2 Eq Time:	0M
Batt2 BST Time:	120M
Batt2 Eq Int:	0D
Batt2 T Comp:	-24
Force CHG:	Normal

[MENU 15]

System Settings	
▶ [ Set Defaults ]	
[ Clear History ]	
	Normal

[MENU 16]





## 4. STATUS, SETTINGS AND COMMANDS

The following table lists all of the status parameters, settings and commands that are available on the controller via the remote display and the Go Power! Connect mobile application. The actual value displayed may be prefaced with "Batt1" or "Batt2" if the remote display is connected to a GP-RVC-MPPT-30 controller since these are dual bank controllers.

RVC CONTROLLER NAME	GO POWER! CONNECT	DEFAULT VALUE	VALUE RANGE	DESCRIPTION
<b>Status Parameters</b>				
PV Voltage	Voltage	N/A	N/A	The solar voltage measured at the solar input terminals on the solar controller
PV Current	Current	N/A	N/A	The solar current measured going into the solar input terminals on the solar controller
CHG STA	Charge State	N/A	N/A	The charge state the solar controller is currently operating in.
BAT Voltage	Voltage	N/A	N/A	The voltage measured at the battery output terminals
Chg Current	Current	N/A	N/A	The current measured going out the battery output terminals
Battery Temp	Not in app	N/A	N/A	The temperature measured using the external temperature sensor (if connected)
Device Temp	Not in app	N/A	N/A	The internal temperature of the solar controller
Fault	Not in app	N/A	N/A	Fault code, if the solar controller is in a fault state
Run Time	Not in app	N/A	N/A	The number of days the controller has been operating for
Total WH	Not in app	N/A	N/A	Total Watt Hours sent to the battery bank
Total Ah	Not in app	N/A	N/A	Total Amp Hours sent to the battery bank
Ah Today	Not in app	N/A	N/A	Todays Amp Hours sent to the battery bank today
Ah 1 Day Ago	Not in app	N/A	N/A	Todays Amp Hours sent to the battery bank yesterday
Ah 2 Day Ago	Not in app	N/A	N/A	Todays Amp Hours sent to the battery bank day before yesterday
Ah 3 Day Ago	Not in app	N/A	N/A	Todays Amp Hours sent to the battery bank days ago
Solar Rated V	Not in app	N/A	N/A	The maximum solar input voltage the solar controller is rated to handle
Batt Rated V	Not in app	N/A	N/A	The maximum battery voltage the solar controller is rated to handle
Batt Rated I	Not in app	N/A	N/A	The maximum charge current the solar controller is capable of producing
FW Ver	Not in app	N/A	N/A	Firmware Verison of solar controller
HW Ver	Not in app	N/A	N/A	Hardware Version of solar controller
SN Num	Not in app	N/A	N/A	Serial number of solar controller
Type	Not in app	N/A	N/A	This is a parameter the remote reads from the solar controller to determine which type of solar controller is connected so it can adjust it's display accordingly.
<b>BASIC SETTINGS</b>				
I Limit	Charging Current Limit	30A	1 - 30A	This is the maximum current that will be used to charge the battery.



## STATUS, SETTINGS AND COMMANDS

Type	Battery Type	GEL	Flooded, GEL, AGM, Li, USER (Custom)	Since each type of battery is charged and maintained differently, the battery type must be set to match the battery connected to the controller.  When the battery type is changed the following characteristics will change according to the battery type.
Nom V	System Voltage	AUTO	AUTO, 12V, 24V	The nominal voltage of the battery bank. This is only configurable for lithium batteries. For all other battery types it is auto detected.
AH	Capacity	200Ah	1 - 9999Ah	The nominal battery capacity is used to adjust the capacity to match the batteries being used in the application
<b>ADVANCED SETTINGS</b>				
OVP	High Voltage Disconnect	16V	0 - 17V	The voltage when the solar controller will disconnect the charger from the battery and indicate a high voltage fault
Eq V	Equalization Voltage	14.1V	0 - 17V	The equalize voltage is the voltage setpoint used during an equalize maintenance cycle.
Bulk V	Bulk-Absorption Voltage	14.1V	0 - 17V	When the battery reaches the bulk-absorption set point, the controller will start to operate in the absorption stage.
Float V	Float Voltage	13.7V	0 - 17V	After the absorption stage, the controller will reduce the battery voltage to the float voltage set point.
Chg Rtn	Recharge Voltage	13.2V	0 - 17V	This is the voltage setpoint that triggers a new charge cycle.
LRV	Over-discharge return	12.8V	0 - 17V	The over-discharge return voltage is the voltage at which the battery over discharge fault is cleared when the battery is charging back up again from an over-discharged state.
Warn V	Under Voltage Warning	12.0V	0 - 17V	The under-voltage warning level is the voltage at which the under-voltage warning fault state is entered to indicate that an under-voltage condition has been reached.
ODV	Discharge Limit Voltage	11.0V	0 - 17V	The discharge limit voltage is the voltage at which the battery will be disconnected from the solar controller so there is no current draw from the battery. When solar power sufficient to charge the battery becomes available the battery will be connected again.
Batt1 ODVD	Bank 1 Over-discharge Delay Time	5.0S	0 - 300s	The over-discharge time delay is the time that the controller will wait when it sees the voltage fall below the over-discharge voltage and the discharge limit voltage before entering a fault condition. The purpose of this setting is to prevent the controller from alerting the user or disconnecting the battery when a temporary surge is drawn from the battery such as a starter motor or AC unit that drops the voltage of the battery.
Equ Time	Equalization Duration	0min	0 - 600min	The equalize duration is the amount of time the equalization voltage will be applied to the battery.



## STATUS, SETTINGS AND COMMANDS

BST Time	Absorption Duration	120min	0 - 600min	The absorption duration is the amount of time the bulk-absorption voltage will be applied to the battery during the absorption stage.
Equ Int	Equalization Interval	0days	0 - 250 Days	The equalize interval is the frequency at which an equalize charge will be performed to maintain the battery.
T Comp	Temp Comp Factor	-24mV/C	0 to -30mV/C	The temperature compensation factor is used to adjust the charging current according to the measured temperature of the battery to ensure there is no damage to the battery. This is not valid for Lithium batteries.
<b>COMMANDS</b>				
Force CHG	Not in App	Normal	Normal, Main Bulk, Main Flt, Alx Bulk, Alx Flt	Force the controller into either bulk or float charge stage on either battery bank 1 or 2
Set Defaults	Reset to Factory Default	N/A	N/A	Set all settings to default
Clear History	Not in App	N/A	N/A	Reset historical data



## 5. CHARGE STATES AND FAULTS

The main screen has a section at the bottom (indicated in the images below) to indicate either charge state if the controller is charging normally or fault information if the controller has entered a fault state. All of the possible charge states and fault states are listed in the table below. The actual value displayed may be prefaced with "BAT1" or "BAT2" if the remote display is connected to a GP-RVC-MPPT-30 controller since these are dual bank controllers.

30A Solar Controller:

Solar	<b>0.0V</b>	<b>0.0A</b>
BAT1	<b>12.2V</b>	<b>0.0A</b>
BAT2	<b>10.5V</b>	<b>0.0A</b>
25°C	<b>Error: BAT2:UVP</b>	

10A Solar Controller:

Solar	<b>0.0V</b>	<b>0.0A</b>
BAT	<b>10.5V</b>	<b>0.0A</b>
25°C	<b>Error: BAT2:UVP</b>	

IDLE	Solar controller is not charging either because there is no sunlight available or because the battery is fully charged
CHARGING:BULK	Charger is in the bulk charging stage with all power available up to the maximum rated current. The solar controller will use MPPT to get the as much power as possible from the solar array.
CHARGING:ABSORB	Charger is in the absorption charging stage and is holding the battery voltage at the bulk-absorption (also called boost) voltage.
CHARGING:FLOAT	Charger is in the float charging stage and is holding the battery voltage at the float voltage.
CHARGING:EQUALIZING	Charger is in the equalize charging stage and is holding the battery voltage at the equalize voltage.
PV:REVERSE	The solar input voltage is connected with reverse polarity.
PV:OVP	The solar input voltage is above the maximum rated voltage for the solar controller. If this error is observed the controller may be damaged and the solar array has not been configured correctly.
BAT:REVERSE	The battery connected to the battery output has been connected with reverse polarity.
BAT:WAR	The voltage of the battery connected to the battery output is below the under voltage warning voltage.
BAT:UVP	The voltage of the battery connected to the battery output is below the discharge limit voltage.
BAT:OVP	The voltage of the battery connected to the battery output is above the high voltage disconnect voltage.
BAT:NC	There is no voltage detected on the battery output.

## 6. COMMANDS

---

### FORCE CHARGE

The force charge commands are used to force the solar controller into either bulk charging or float charging. This can be done on both the GP-RVC-MPPT-10 and the GP-RVC-MPPT-30. On the GP-RVC-MPPT-30 the force charge commands give the option to force charge either battery so, for example, if Bat1 is connected to the house battery and Bat2 is connected to the starter battery and both batteries are low the force charge command can be used to force the charger into charging Bat2 instead of its usual priority, Bat1.

If the battery voltage is below the bulk-absorption voltage and the force to bulk command is issued the controller will enter a bulk charge state and provide maximum current to the battery bank according to the charging current limit setpoint. Regardless of the state of the other battery (if using GP-RVC-MPPT-30) the controller will continue to bulk charge this battery until the bulk-absorption setpoint is reached, then it will enter its normal priority sequence.

If the battery voltage is higher than the float voltage and the force to float command is executed the controller will enter a float charge stage and allow the voltage to lower to the float voltage setpoint. This command is used to cancel an absorption charge early, so the normal priority sequence is still followed. Thus, if Bat1 ever goes below the recharge voltage setpoint the controller will still switch to Bat1 and start bulk charging.

The force charge command can also be cancelled by choosing the "Normal" option, which will cause the controller to go back to its regular priority sequence.

The force charge commands are found in the settings menu and is executed by scrolling to the line that says "Force CHG" and pressing the [ENTER] button. The [UP] and [DOWN] arrows can then be used to select the desired force charge command before executing the command using the [ENTER] button.

### RESET TO DEFAULTS

The reset to default command is used to reset all configurable parameters on the solar controller to factory defaults. This command is found in the settings menu and is executed by scrolling to the line that says [ Set Defaults ] and pressing the [ENTER] button.

### CLEAR HISTORY

The reset to default command is used to reset all configurable parameters on the solar controller to factory defaults. This command is found in the settings menu and is executed by scrolling to the line that says [ Set Defaults ] and pressing the [ENTER] button.



## 7.1 Device Status Screens

The information below outlines how to navigate the status screens of the RVC Remote in a system with multiple GP-RVC-30-MPPT controllers connected to the same battery bank in parallel. These instructions are intended to assist with using the remote prior a pending update to the manual that will include this information.

### 1. Main Screen

The Main Screen is the default state of the RVC Remote. The image below shows the Main Screen layout with multiple GP-RVC-30-MPPT controllers connected

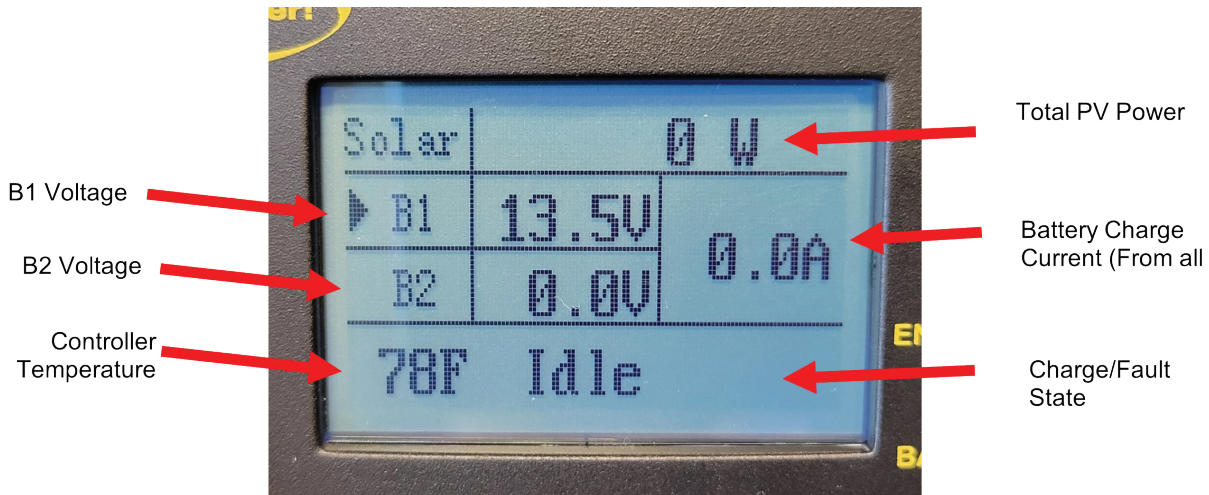

### 2. Device Status Screens

#### Step 1

From the Main Screen, short press the [ENTER] button to go to the Device Status interface.

**Note** Information in these screens relates to all controllers connected to the system

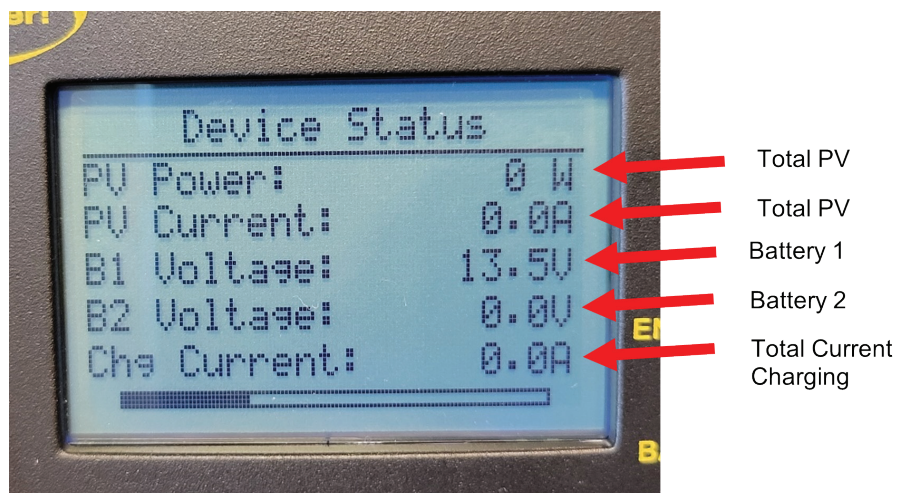

## PARALLEL CONTROLLER STATUS

### Step 2

Short press [DOWN] to go to Device Status screen 2.

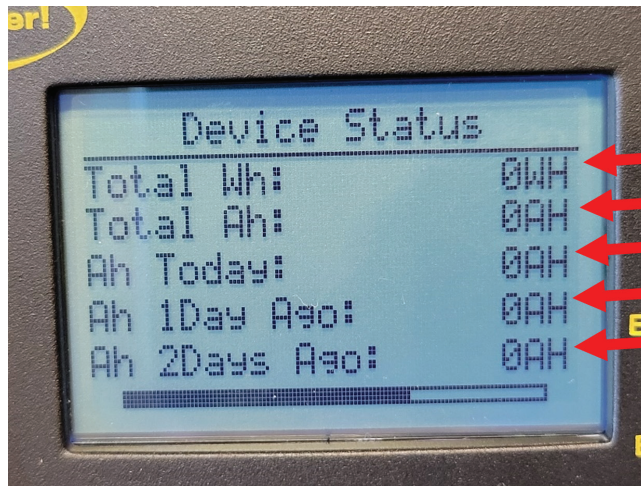

Total Wh to Battery

Total Ah to Battery

Total Ah to Battery Bank today

Total Ah to Battery Bank

Total Ah to Battery Bank 2 days

### Step 3

Short press [DOWN] to go to Device Status screen 3.

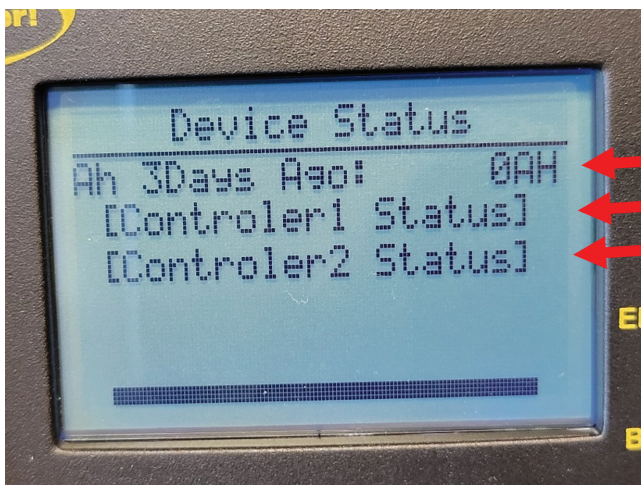

Total Ah to Battery Bank 3 days

Controller 1 Status

Controller 2 Status

### Step 4

Short press [DOWN] to highlight each Controller Status link (eg. [Controller1 Status]).

### Step 5

Short press [ENTER] to go to the selected Controller Status screen 1.

**Note**

Any additional controllers connected will appear below Controller2 Status.



## 7.2 Controller Status Screens

**Note**

Information in these screens relates only to the one controller selected. Controller 1 is used for example, but any other controller connected will have the same screens available

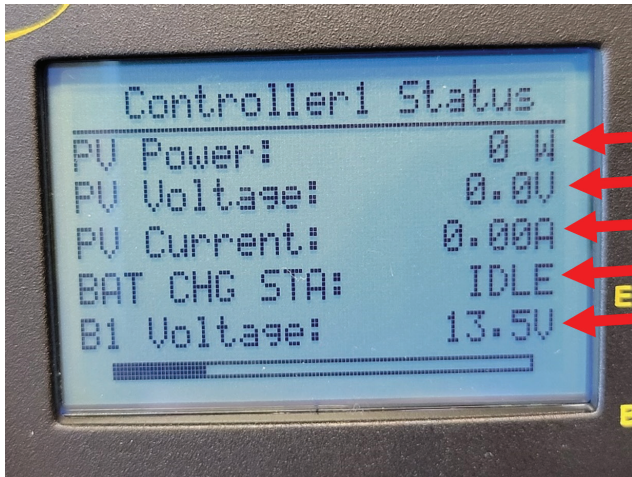

- Controller 1 PV Power
- Controller 1 PV
- Controller 1 PV Current
- Controller 1 Battery Charge State
- Battery 1 Voltage

Step 1

Short press [DOWN] to go to Controller Status screen 2.

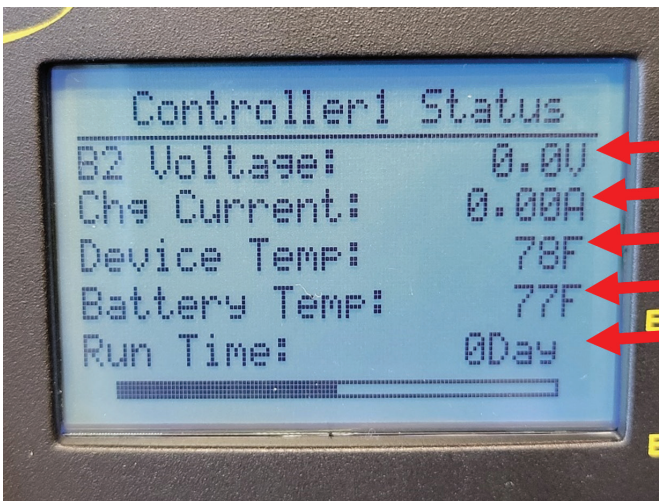

- Battery 2 Voltage
- Controller 1 Current to B1 and
- Controller 1 Internal Temperature
- Controller 1 External Temperature
- Controller 1 Run Time



# PARALLEL CONTROLLER STATUS

Step 2

Short press [DOWN] to go to Controller Status screen 3

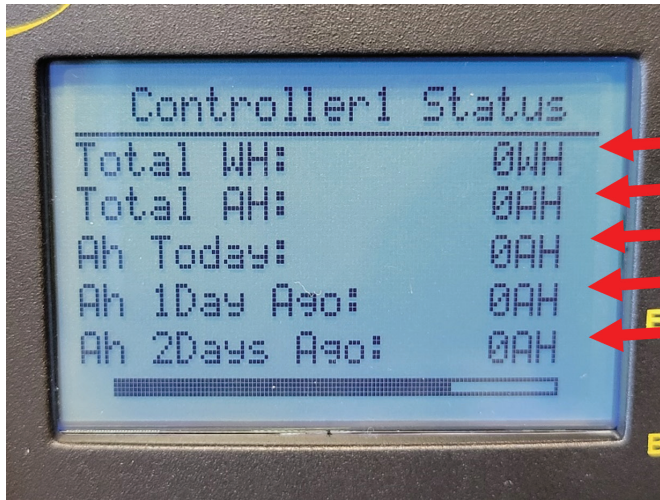

- Controller 1 Total Wh
- Controller 1 Total Ah
- Controller 1 Ah today
- Controller 1 Ah yesterday
- Controller 1 Ah 2 days ago

Step 3

Short press [DOWN] to go to Controller Status screen 4.

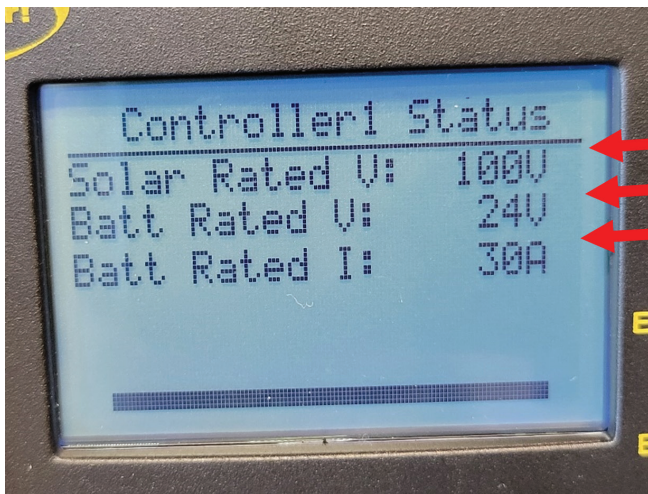

- Controller 1 Max Solar Voltage
- Controller 1 Max Battery Voltage
- Controller 1 Max Battery Current

Step 4

Short press [BACK] to return to Device Status screens

Short press [BACK] again to return to Main screen



## 8. INSTALLATION

---

The GP-RVC-R is intended to be mounted to an interior wall so the status of the solar controller can be viewed.

### Tools and Materials Needed

- Philips screw driver
- Drill
- 1" diameter drill bit or hole saw

### Installation Steps

THIS REMOTE DISPLAY CAN BE MOUNTED USING THE FOLLOWING STEPS.

1. Plan the location of your remote display carefully keeping in mind the cable needs to be run from the solar controller to the remote.
2. Use the installation template on the last page of this manual to determine the hole location based on the desired remote display location.
3. Drill a 1" diameter hole.
4. Run the cable from the solar controller location and feed it through the cut hole.
5. Connect the cable to the remote display
6. Use provided screws to attach the remote display to the wall
7. Snap the cover plate onto the remote display to hide the screws

## 9. BLUETOOTH® WIRELESS TECHNOLOGY

The GP-RVC-R comes with Bluetooth® wireless technology for live status monitoring and settings configuration on mobile devices. It works together with the Go Power! Connect App, available for both Android and iOS devices.



Download and install the Go Power! Connect app, which is available on the Google Play store for Android devices and the App Store for iOS devices.

### 9.1 PAIRING

When connecting for the first time, pairing between the charge controller and the mobile device is required. Also ensure your mobile device's Bluetooth® communication function is enabled. You will see the Bluetooth® symbol present on your status bar if so.

Open the app, and the Main page will prompt you to select devices.

#### TO PAIR:

Once this pairing process has been initiated on the remote, select the remote in the Device Selection main page of the Go Power! Connect app.

Device selection must be performed while the Bluetooth® symbol is visible.

Selecting the device will finalize the pairing process and a connection will be automatically established.

### 9.2 STATUS DISPLAY

#### 10A Solar Controller

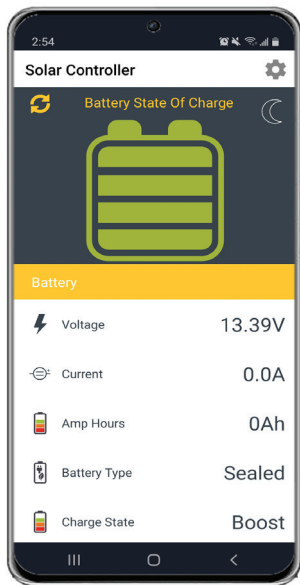

#### 30A Solar Controller

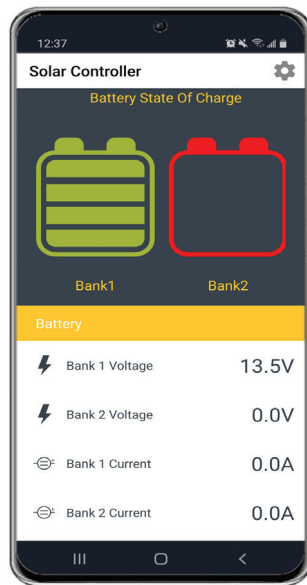



8.3 SOC INDICATION

SYMBOL	BATTERY VOLTAGE
	$\geq 12.8 / 25.6 \text{ V}$
	$\geq 12.6 / 25.2 \text{ V to } 12.8 / 25.6 \text{ V}$
	$\geq 11.8 / 23.6 \text{ V to } 12.6 / 25.2 \text{ V}$
	$\geq 11.0 / 22.0 \text{ V to } 11.8 / 23.6 \text{ V}$
	$\leq 11.0 / 22.0 \text{ V}$

Note there are two different system voltages that can be supported: 12V and 24V. If the voltage read from the controller is less than 18V the system voltage shall be 12V. If the voltage is greater than 18V the system voltage shall be 24V.



## 10. LIMITED WARRANTY

---

Go Power! warrants the GP-RVC-R for a period of five (5) years from the date of shipment from its factory. This warranty is valid against defects in materials and workmanship for the five (5) year warranty period. It is not valid against defects resulting from, but not limited to:

- Misuse and/or abuse, neglect or accident
- Exceeding the unit's design limits
- Improper installation, including, but not limited to, improper environmental protection and improper hook-up
- Acts of God, including lightning, floods, earthquakes, fire, and high winds
- Damage in handling, including damage encountered during shipment

This warranty shall be considered void if the warranted product is in any way opened or altered. The warranty will be void if any eyelet, rivets, or other fasteners used to seal the unit are removed or altered, or if the unit's serial number is in any way removed, altered, replaced, defaced, or rendered illegible.

### 9.1 REPAIR AND RETURN INFORMATION

Visit <https://gpelectric.com/support/> to read the "frequently asked questions" section of our website to troubleshoot the problem. If trouble persists:

1. Fill out our online Contact Us form or Live Chat with us
2. Email [techsupport@gpelectric.com](mailto:techsupport@gpelectric.com)
3. Return defective product to place of purchase



# 11. MOUNTING TEMPLATE

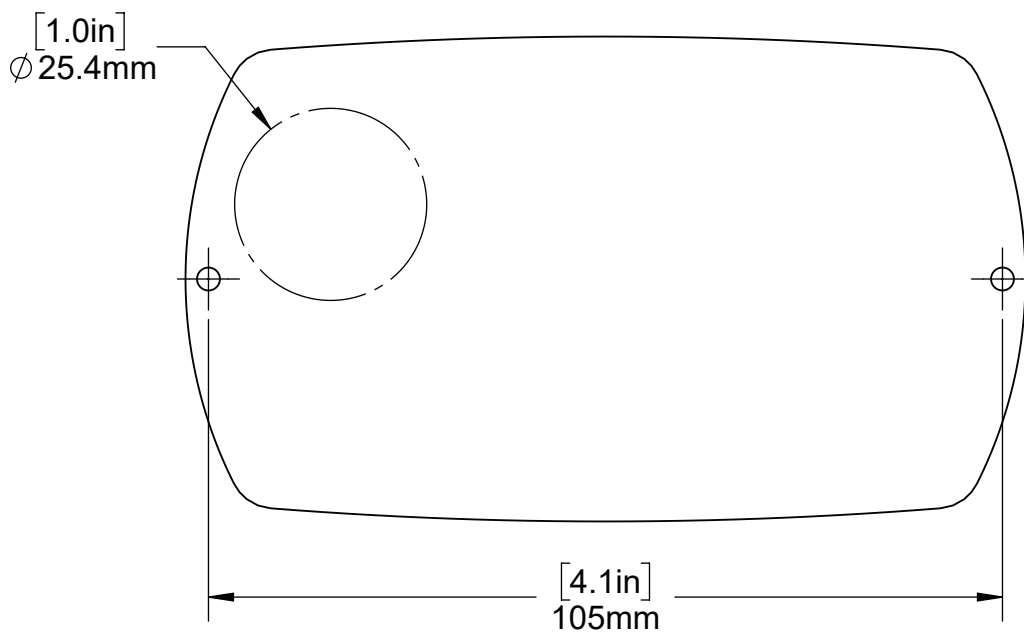

© 2022 Go Power!

Worldwide Technical Support and Product Information [gpelectric.com](http://gpelectric.com)

Go Power! | Dometic

201-710 Redbrick Street Victoria, BC, V8T 5J3

Tel: 1.866.247.6527

GP-RVC-R Manual\_RevB

