

Assembly Instructions

Swing Set



- We recommend 2+ adults for assembly.
- Before starting assembly, please make sure the parts are complete, identify and separate all parts first.
- Keep this manual for future reference.

SAFETY INSTRUCTIONS

The Safety Of Your Children Is Our Primary Concern!

1. The swing set is not intended for public use. ONLY intended for domestic use.
2. Children MUST NOT use this swing set until the unit has been completely assembled.
3. We recommend that you set up the swing set on an even surface and maintain a distance of at least 2m from other structures or obstacles, e.g. fence, garage, house, projecting branches, clotheslines or electric cables.
4. Not suitable for children under 3 years of age. Risk of Strangulation and Choking with Long Rope and Small Parts!
5. Never leave your child unsupervised on the swing, in order to avoid the risk of falling down.
6. DO NOT allow children to walk close to, in front of, behind, or between moving swings or other moving playground equipment.
7. Instruct children to avoid swinging empty seats.
8. Teach children to sit in the center of the swings with their full weight on the seats, never stand or kneel on the swing seat.
9. Instruct children NOT to get off the swing while it is in motion.
10. The recommend height from the ground to swing seat is 20in (50cm).

MAINTENANCE INSTRUCTIONS

1. IT IS IMPORTANT TO CHECK AND TIGHTEN ALL HARDWARE AT THE BEGINNING AND DURING THE SEASON, otherwise the equipment may overturn and/or become a hazard.
2. Do not expose the swing to the weather during longer periods of rain and in autumn / winter.
3. Always replace defective parts with original spares.

At the beginning of each play season

1. Tighten all hardware.
2. Lubricate all metallic moving parts.
3. Check all protective coverings on bolts, pipes, edges and comers. Please replace in time if they are loose, cracked or missing.
4. Check all moving parts including ropes, swing seats, cables and chains for wear, rust or other deterioration.

Twice a month during play season

1. Tighten all hardware.
2. Check all protective coverings on bolts, pipes, edges and comers. Please replace in time if they are loose, cracked or missing.

Once a month during play season











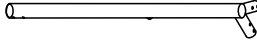

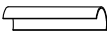
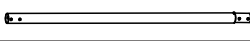
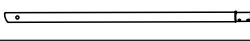
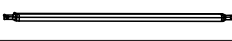



1. Lubricate all metallic moving parts.
2. Check all moving parts including ropes, swing seats, cables and chains for wear, rust or other deterioration.

At the end of each play season or when the temperature drops below 32°F

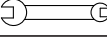
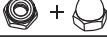
- Remove plastic swing seats and other items and take them indoors or do not use.
- Rake and check depth of loose fill protective surfacing materials to prevent compaction and maintain appropriate depth. Replace as necessary.

PARTS LIST

- Before assembling, please check and make sure the parts are complete.

Quantity		Part Picture	Part Name
2	A		A tube
1	B		B tube
2	C		Reinforcing armor
4	D		D top Leg
4	E		E bottom Leg
2	F		F side bar
4	G		Anchor
4	G1		M8 eye bolt + washer + big washer + M8 nonslip nut
1			Iron bar for anchor installation
16	H		Bolt
3	I		Long bolt
20	J		Nut for frame
40	K		Washer
1	L		Eyebolt
1	M		Spanner
1	M8		2*nut+1*nut cap(for eyebolt)
1			Swing seat
2			Suspension ropes and bolts(include nut and washer)
1			Spanner
4	M8		Nut cap(for swing)
2			Carabiner
1			Swivel

Assembly Instructions

We recommend 2+ adults for assembly.

Before starting assembly, please make sure the parts are complete, identify and separate all parts first.

Step1: Insert B tube into one of the A tubes , then align a long bolt to the hole position and insert it into the tube from the top.

(Tips: This bolt is for fixation and needs to be removed at step 3.)

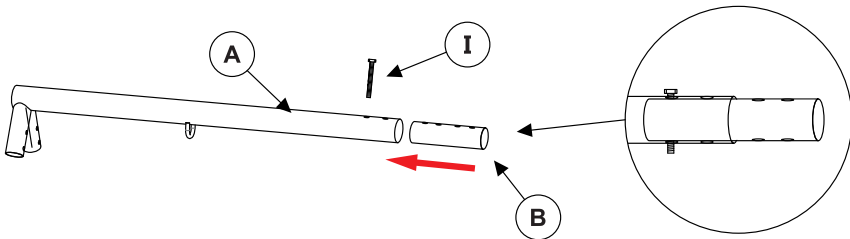

Step2: Put a piece of reinforcing armor on the bottom of tube, then insert a long bolt with washer from the bottom of tube. (Attention: All the bolts on the tubes need to face upwards.)

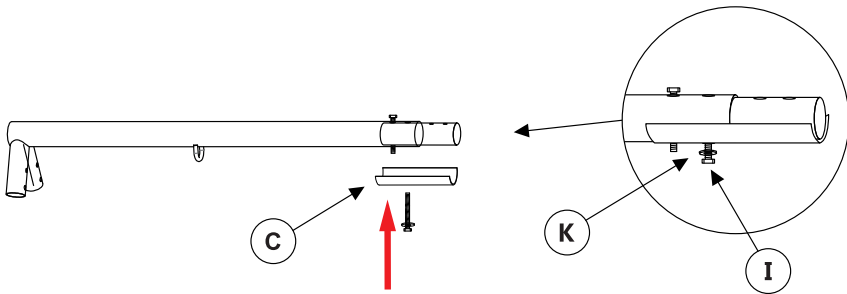

Step3: Remove the long bolt on the left, then put the other piece of reinforcing armor on the top of tube. Insert the washer and lock nut, then use the big head of one spanner to fix the bolt on the bottom, use the other spanner to screw as shown in the picture below.

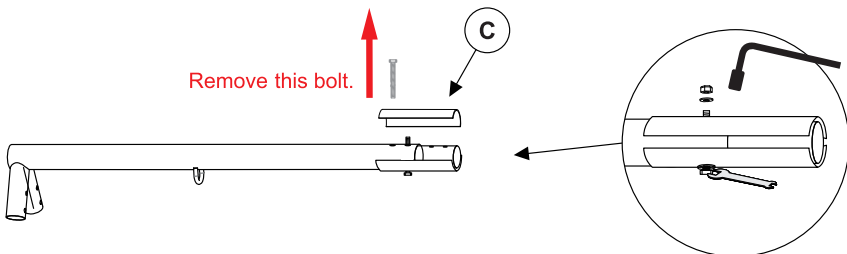

Step4: Insert the other A tube into the B tube, make sure these holes are overlapped, then insert a long bolt with washer from the bottom of tube.

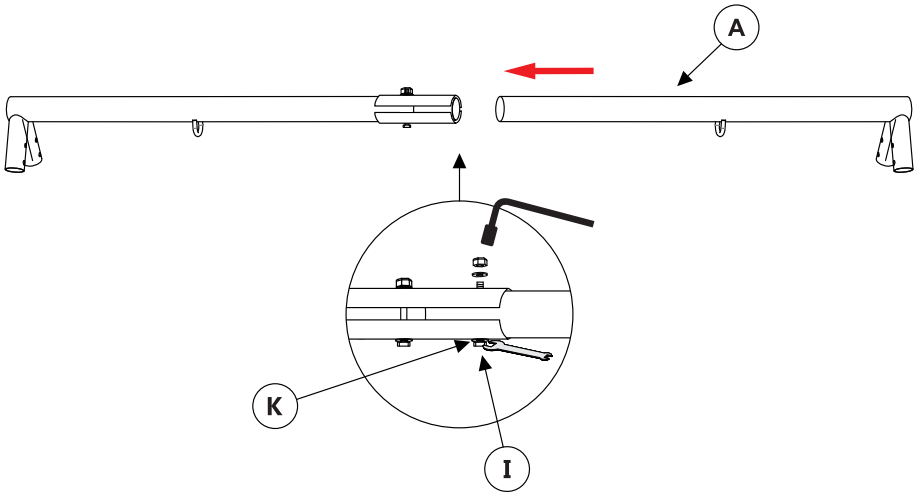

Step5: Install the washer and tighten the lock nut with spanner. (Attention: All the bolts on the tubes need to face upwards.)

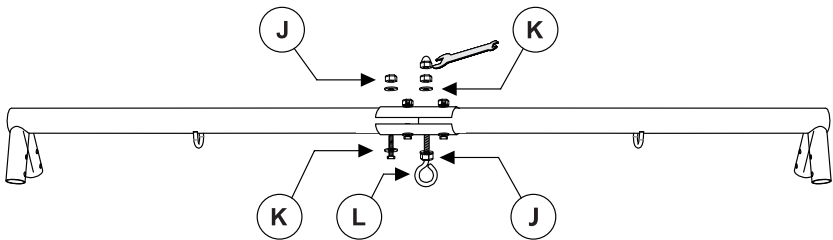

Eyebolt installation:

Insert the eyebolt with tightened nut and washer from the bottom of the tube, then put the washer and nut onto the bolt from the top, and tighten it with a spanner, then put the nut cap and tighten it.

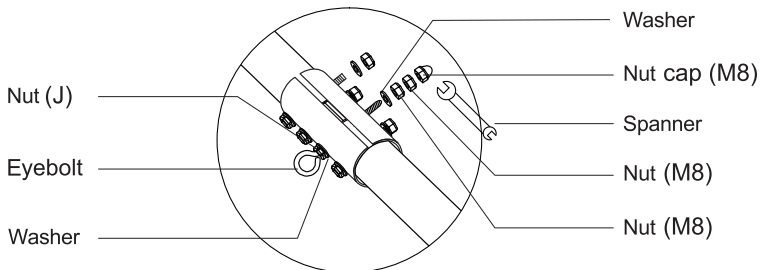

Step6: Install the D top Leg and tighten the screws with a spanner.
(Attention: all the bolts on the leg tubes need to face outwards.)

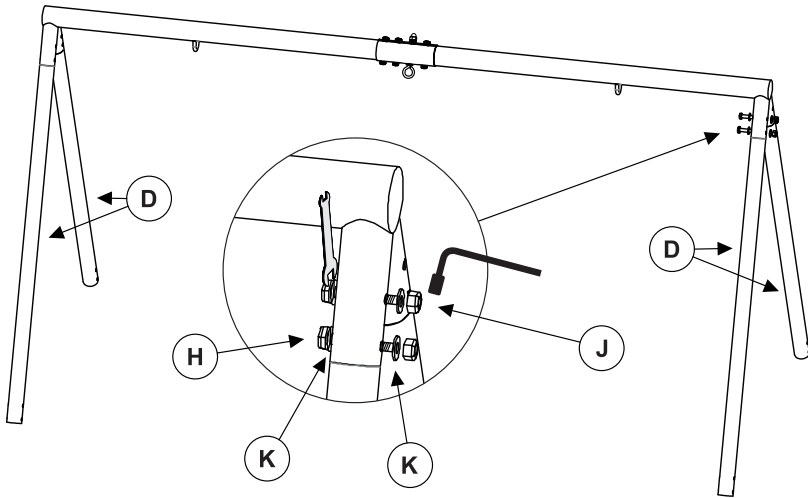

Step7: Install the E bottom leg, then install the F side bar to the lower holes.
(Note: The side tubes should be installed on the outside of the brackets.)

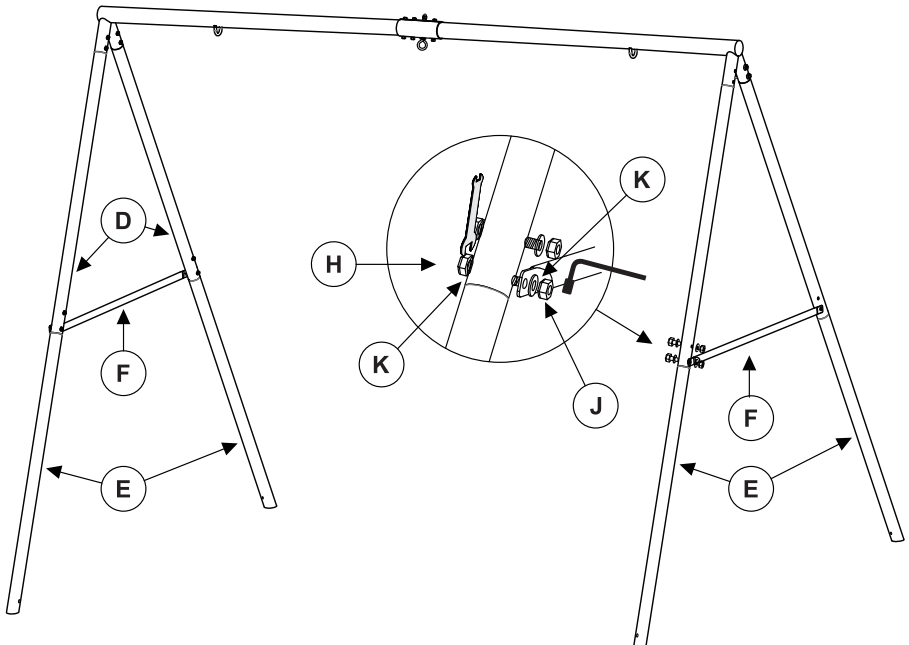

F side bar Installation

Follow the below steps to install the F side bars after you finish Step 7 installing the leg tubes:

1. Install one side of the F side bar to the LOWER hole on one leg tube, and screw it tightly.

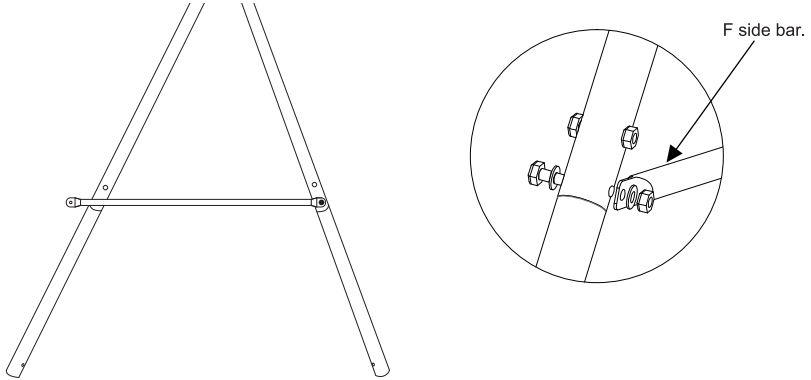

2. Hold the other leg tube and pull it outwards until the bar hole align to the LOWER tube hole.

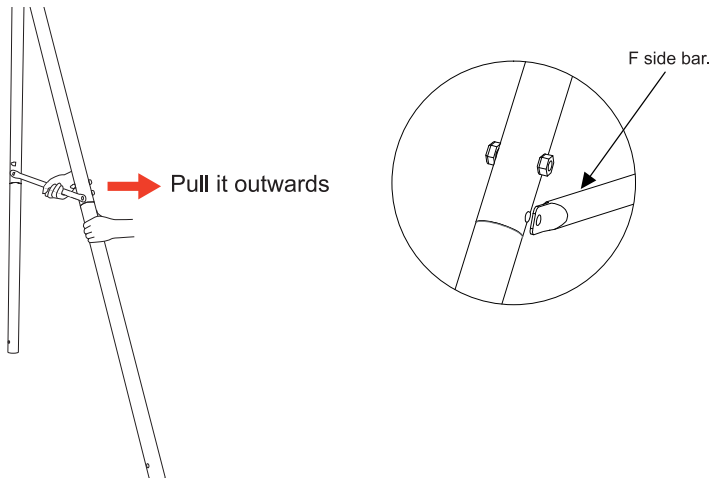

**Tips: Do not install the bars directly without pulling the leg tube outwards.
Otherwise, you will find the side bars are too long.**

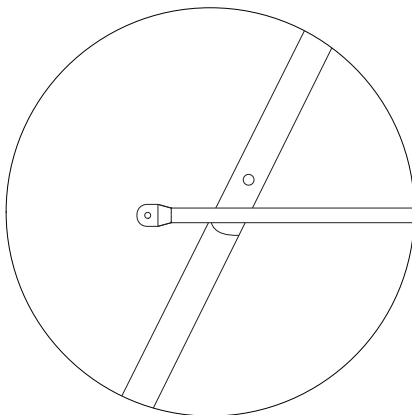

3. Insert the nuts and screw it tightly.

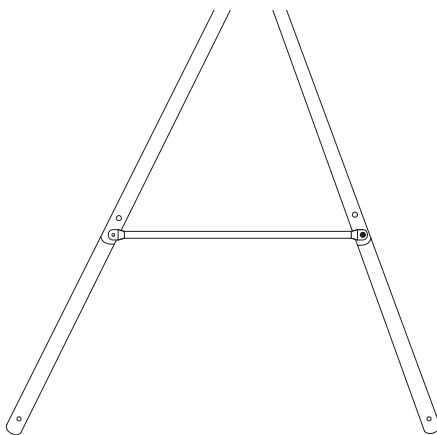

Step8: Install all the anchors.

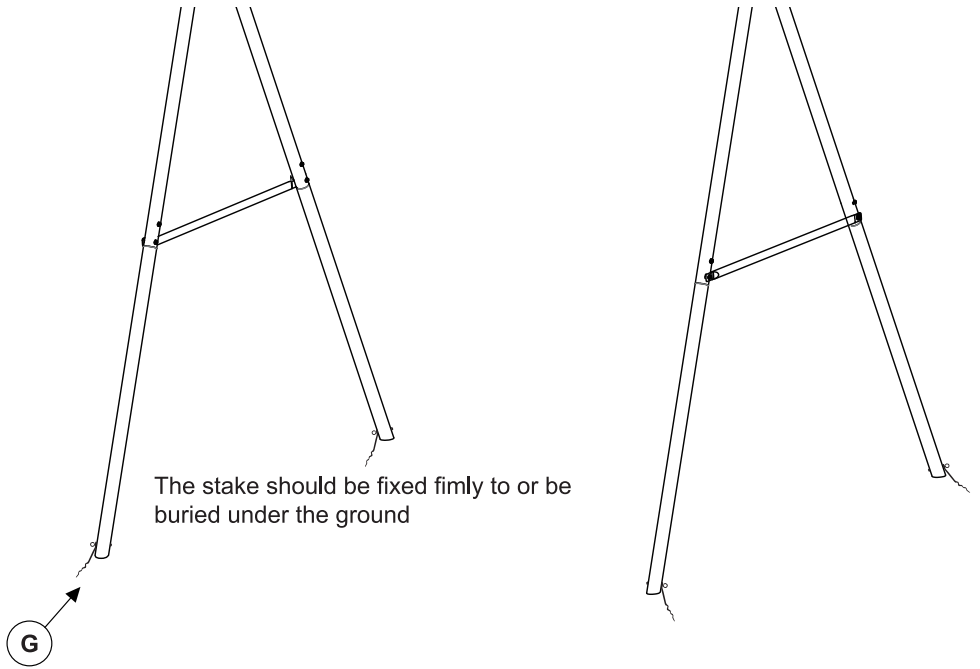

1. Use the iron bar to fix the ground stake to the position you intended.
2. Fix the swing frame with around stake.
3. Fasten the ground stake with G1.

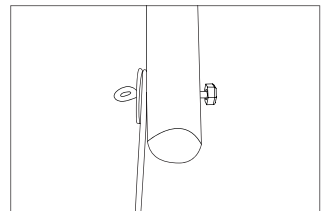
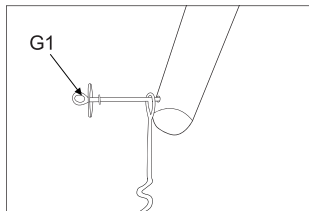
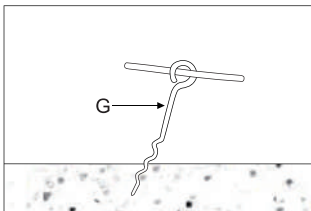

SWING ASSEMBLY INSTRUCTION

You can search the operation video "Trekassy swing instructions" on Youtube.

Tips: This is the general user manual of swing, the actual color refers to the item you purchased.

Figure 1: Insert 4 tubes into EVA foam tubes.

Figure 2: Insert 4 tubes with EVA foam padded into swing seat. (Attention: A bigger tube end is matched with a smaller one. If they are in the same size, it is unable to connect them.)

Figure 3: Joint random two adjacent tubes.

Figure 4: Joint other two adjacent tubes then you will get two semi-circle tubes.

Figure 5: Cover it up with Hook&Loop then insert the bolt into the hole at the joint.

Figure 6: Connect left two joint and you will get a round swing seat.

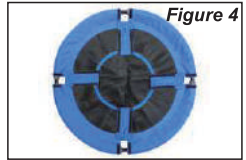
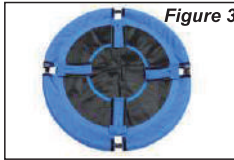
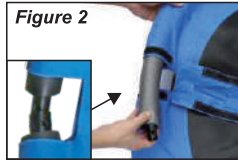
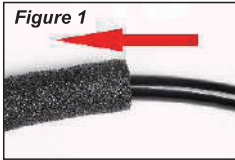
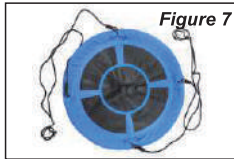

Figure 5: Cover it up with Hook&Loop then insert the bolt into the hole at the joint.

Figure 6: Put the washer and nut onto the bolt, and tighten with a wrench until 3-4 threads of bolts are exposed, then put the nut cap onto the bolt and tighten it. Please make sure all the screws are tightened for your safety. (You need an open-end wrench to fasten nut and nut cap.)

Figure 7: Assembly complete.



INSTALLATION

Figure 1: Connect the ropes to the swing frame with carabiners. (Note: Make sure the screw lock of carabiner is 100% tightened.)

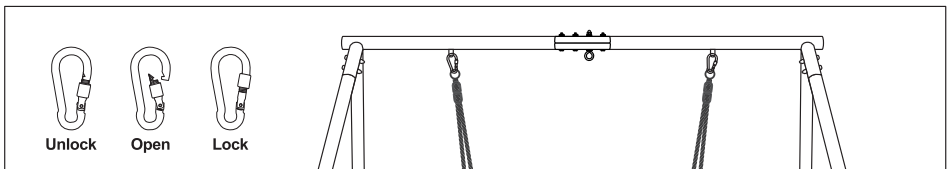

Figure 2: Adjust the rope to a desired length and keep balance.

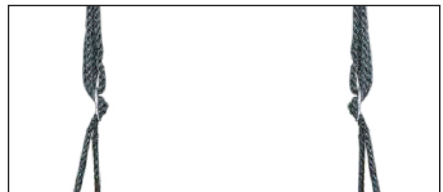

Figure 3: Installation complete.

