

Assembly Instructions

Swing Set

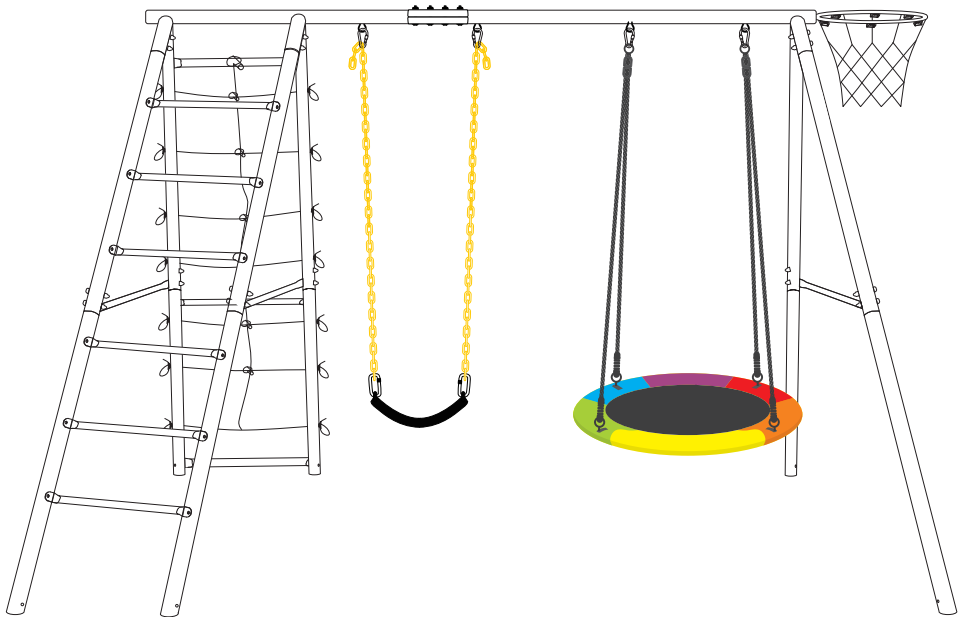

We recommend 2+ adults for assembly.

Before starting assembly, please make sure the parts are complete, identify and separate all parts first.

Keep this manual for future reference.

SAFETY INSTRUCTIONS :

The Safety Of Your Children Is Our Primary Concern!

- The swing set is not intended for public use. ONLY intended for domestic use.
- All who participate in the assembly process should wear safety glasses throughout the assembly.
- Children MUST NOT use this swing set until the unit has been completely assembled.
- We recommend that you set up the swing set on an even surface and maintain a distance of at least 2m from other structures or obstacles, e.g. fence, garage, house, projecting branches, clotheslines or electric cables.
- Not suitable for children under 3 years of age. Risk of Strangulation and Choking with Long Rope and Small Parts!
- Never leave your child unsupervised on the swing, in order to avoid the risk of falling down.
- DO NOT allow children to walk close to, in front of, behind, or between moving swings or other moving playground equipment.
- Instruct children to avoid swinging empty seats.
- Teach children to sit in the center of the swings with their full weight on the seats, never stand or kneel on the swing seat.
- Instruct children NOT to get off the swing while it is in motion.
- The recommend height from the ground to swing seat is 20in (50cm).

MAINTENANCE INSTRUCTIONS :

- IT IS IMPORTANT TO CHECK AND TIGHTEN ALL HARDWARE AT THE BEGINNING AND DURING THE SEASON.
- Do not expose the swing to the weather during longer periods of rain and in autumn / winter.
- Always replace defective parts with original spares.

At the beginning of each play season

- Tighten all hardware.
- Lubricate all metallic moving parts.
- Check all protective coverings on bolts, pipes, edges and comers. Please replace in time if they are loose, cracked or missing.
- Check all moving parts including ropes, swing seats, cables and chains for wear, rust or other deterioration.

Twice a month during play season

- Tighten all hardware.
- Check all protective coverings on bolts, pipes, edges and comers. Please replace in time if they are loose, cracked or missing.















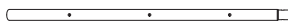
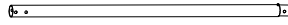

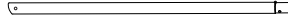



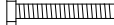
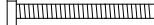

Once a month during play season

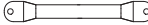
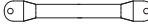

- Lubricate all metallic moving parts.
- Check all moving parts including ropes, swing seats, cables and chains for wear, rust or other deterioration.

At the end of each play season or when the temperature drops below 32°F

- Remove plastic swing seats and other items and take them indoors or do not use.

Parts List :

Quantity	Part Picture	Part Name
1	A1 	A1 tube
1	A2 	A2 tube
1	B 	B tube
2	C 	Reinforcing armor
2	D1 	D1 top Leg with holes for metal ladder
2	D2 	D2 top Leg
2	E1 	E1 bottom leg with holes for metal ladder
2	E2 	E2 bottom Leg
3	F 	F side bar
6	N 	Anchor
1		Iron bar for anchor installation
42	O 	M8 bolt
4	P 	M8 long bolt
46	J 	Nut
93	K 	Washer
1	M 	Spanner
1	G 	Leg tube with net
6	H 	Short tube for metal ladder(yellow)
3	R 	Short tube for climbing net(blue)
2	I 	Tube for basketball hoop
1	L 	Net for basketball hoop
3	Q 	M6 bolt (for basketball hoop)
6	S 	M8 eye bolt + washer + big washer + M8 nonslip nut
1		M6 Spanner for basketball hoop
1		Swing seat
4		Carabiner
1		Swing seat







2		Suspension rope with bolt and nut
1		M8 Spanner for swing
4		Nut cap(for swing)

Assembly Instructions

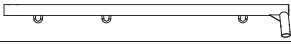
We recommend 2+ adults for assembly.

Before installation, please make sure:

- 1.The ground surface should be flat and tight, not sloping or loose, to prevent the swing from tilting.
- 2.The parts are complete, identify and separate all parts first.

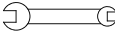
Quantity	Part Picture	Part Name
1	A1 	A1 tube
1	A2 	A2 tube
1	B 	B tube
2	C 	Reinforcing armor
4	P 	M8 long bolt
4	J 	Nut
8	K 	Washer
1	M 	Spanner

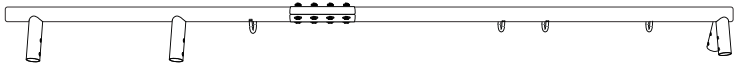

Step1: Insert B tube into one of the A1 tubes, then align a long bolt to the hole position and insert it into the tube from the top.

(Tips: This bolt is for fixation and needs to be removed at step 3.)

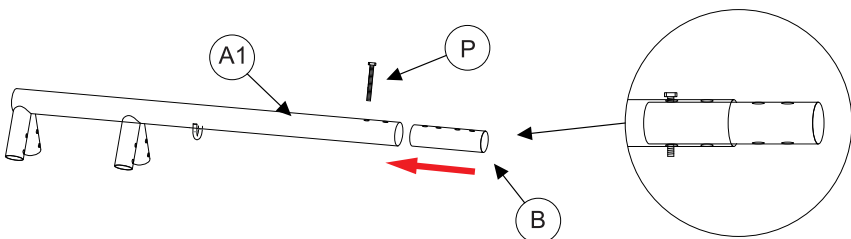

Step2: Put a piece of reinforcing armor on the bottom of tube, then insert a long bolt with washer from the bottom of tube. (Attention: All the bolts on the tubes need to face upwards.)

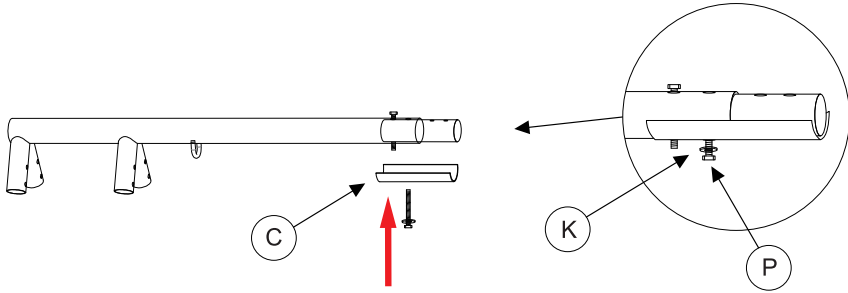

Step3: Remove the long bolt on the left, then put other piece of reinforcing armor on the top of tube.

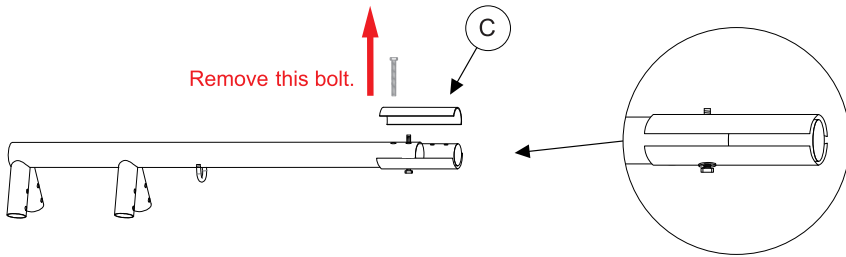



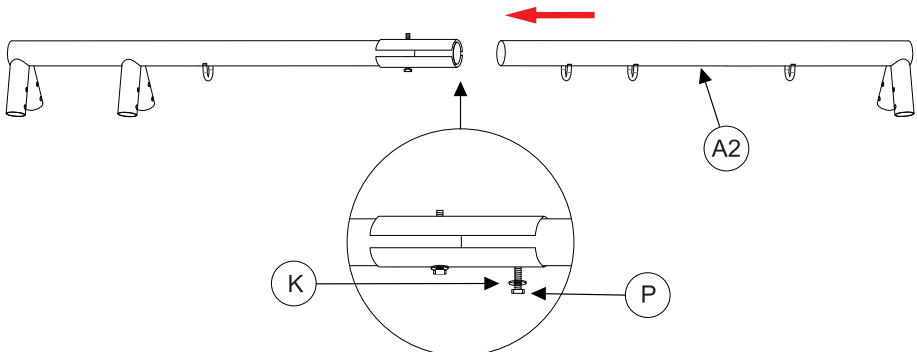

Step4: Insert the other A2 tube into the B tube, make sure these holes are overlapped, then insert a long bolt with washer from the bottom of tube.

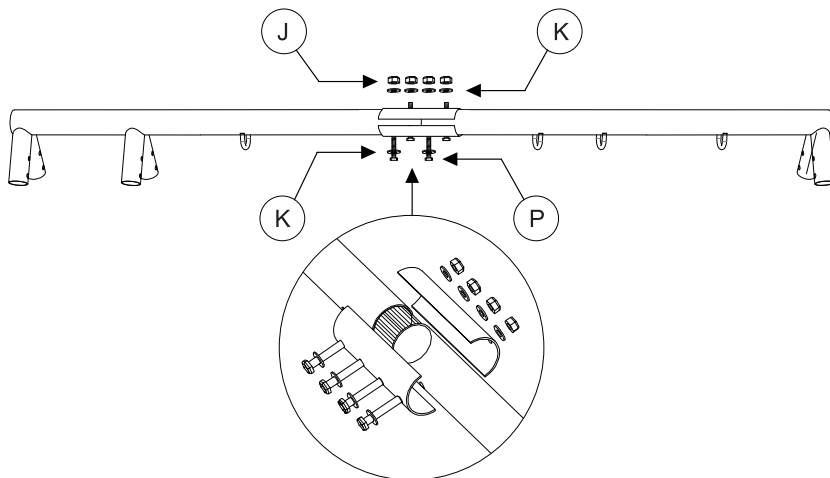

Step5: Install the washer and tighten the nut with spanner. (Attention: All the bolts on the tubes need to face upwards.)

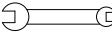

Quantity	Part Picture	Part Name
1		Leg tube with net
3		Short tube for climbing net(blue)
14		M8 bolt
28		Washer
14		Nut
1		Spanner

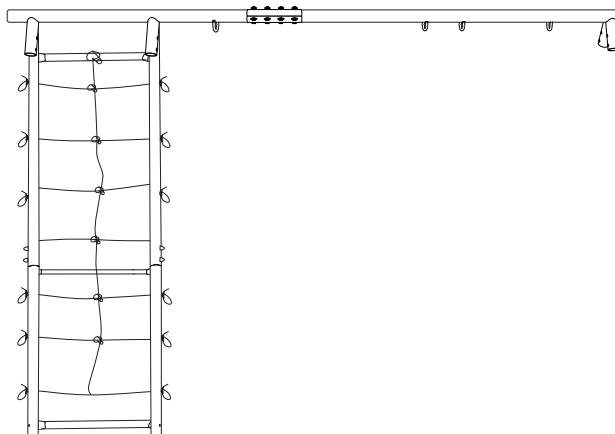

Step6: Joint the tubes of the climbing net(G), then connect it to the A1 tube on one side. Tighten the screws with a spanner. (Screw the nuts on loosely for 2-3 rounds. DO NOT tighten the nuts in case you need to adjust later.)

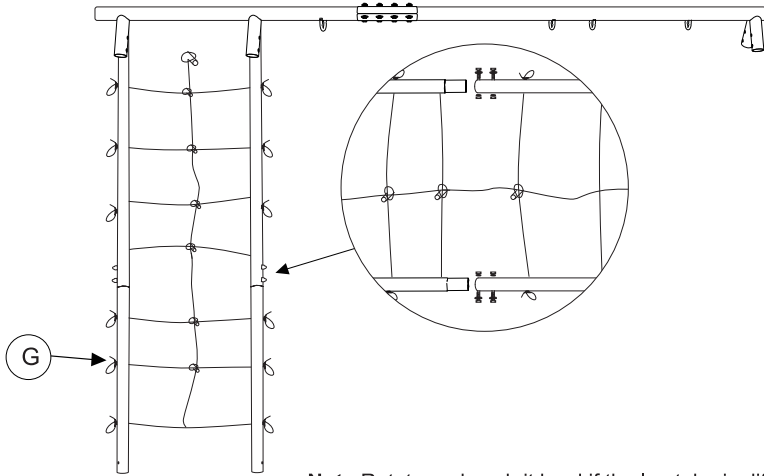







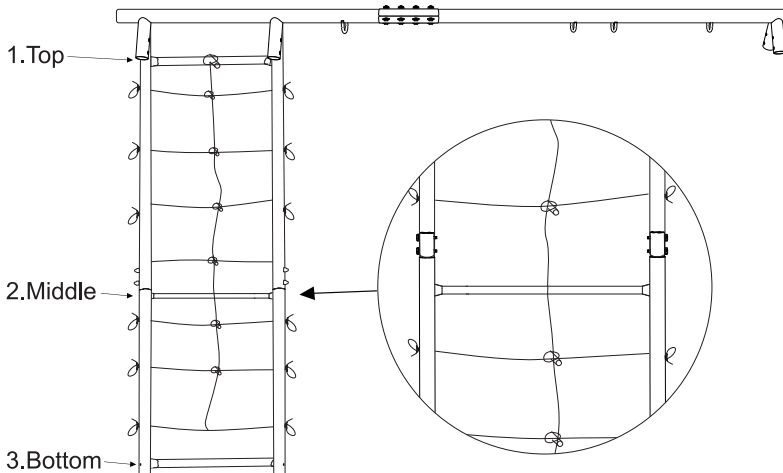

Note: Rotate and push it hard if the leg tube is difficult to insert.

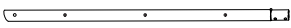
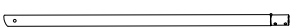
Step7: Install three R tubes on the G (Top, Middle, Bottom three positions).

- ① Top: Put the loop of the net on a R tube, then install the tube on the top of G leg.
- ② Middle: Install a R tube on the middle of the G leg.
- ③ Bottom: Install a R tube on the bottom of the G leg.

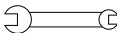

Quantity	Part Picture	Part Name
2	D1 	D1 top Leg with holes for metal ladder
2	D2 	D2 top Leg
2	E1 	E1 bottom leg with holes for metal ladder
2	E2 	E2 bottom Leg
3	F 	F side bar
6	H 	Short tube for metal ladder(yellow)
28	O 	M8 bolt
56	K 	Washer
28	J 	Nut
1	M 	Spanner

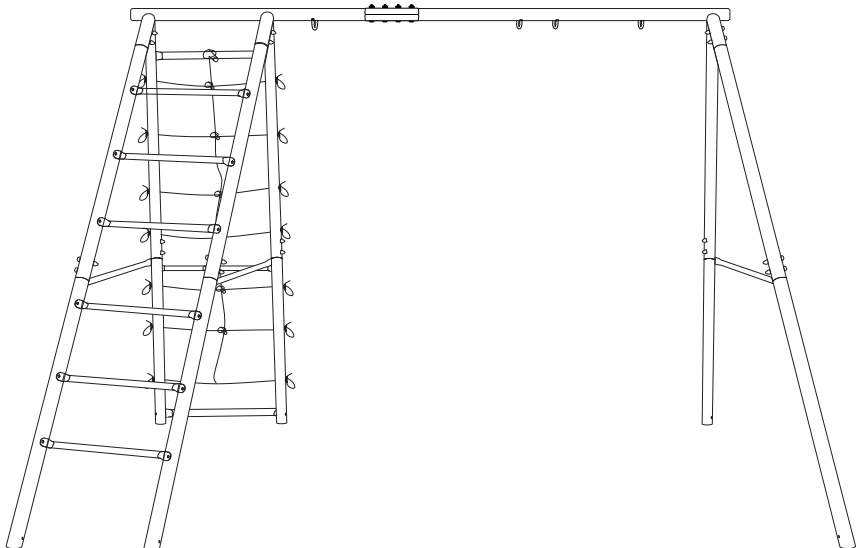

Step8: Install the D1 top leg on A1 tube, install D2 top leg on A2 tube, tighten the screw with a spanner. (Screw the nuts on loosely for 2-3 rounds. DO NOT tighten the nuts in case you need to adjust later.)

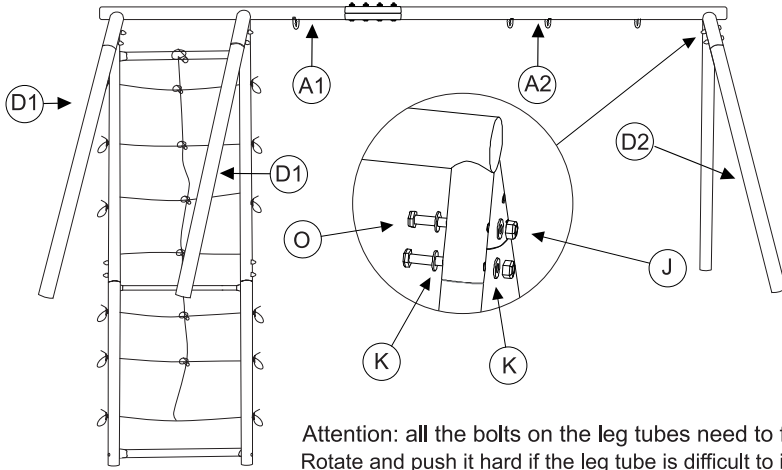

Attention: all the bolts on the leg tubes need to face outwards. Rotate and push it hard if the leg tube is difficult to insert.

Step9: Insert the E1 bottom leg into D1 top leg, E2 into D2, then tighten the screw with a spanner. (Screw the nuts on loosely for 2-3 rounds. DO NOT tighten the nuts in case you need to adjust later.)

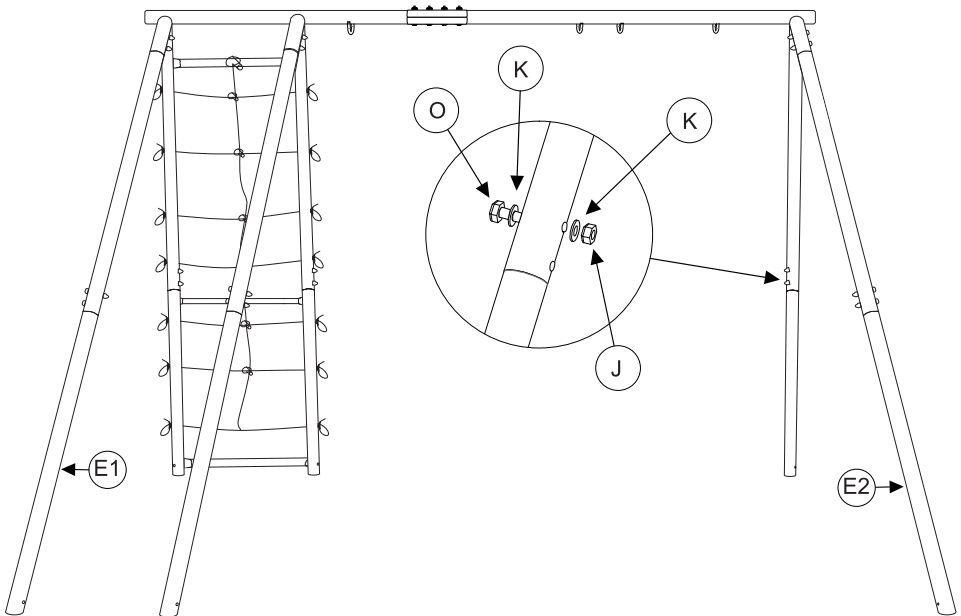

Step10: Install F side bar.

(Note: the side bar should be installed on the outside of the bracket.)

Screw the nuts on loosely for 2-3 rounds. DO NOT tighten the nuts in case you need to adjust later.

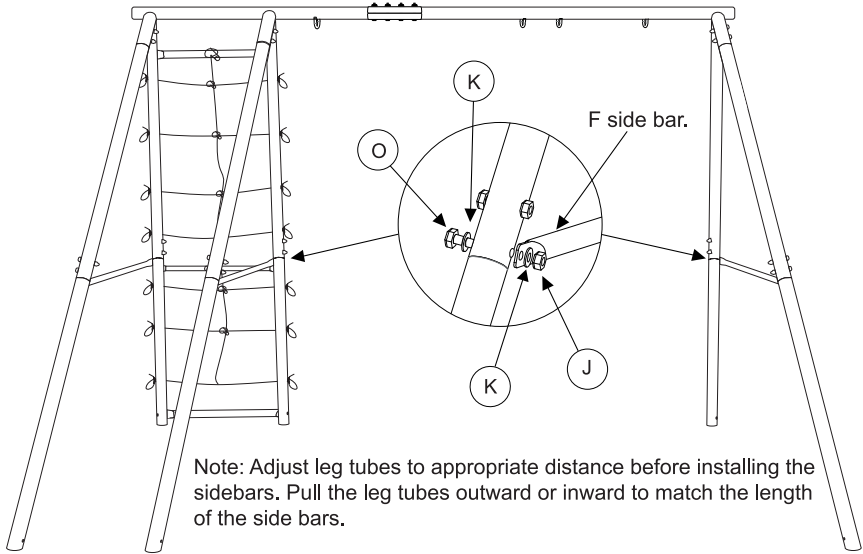

Note: Adjust leg tubes to appropriate distance before installing the sidebars. Pull the leg tubes outward or inward to match the length of the side bars.





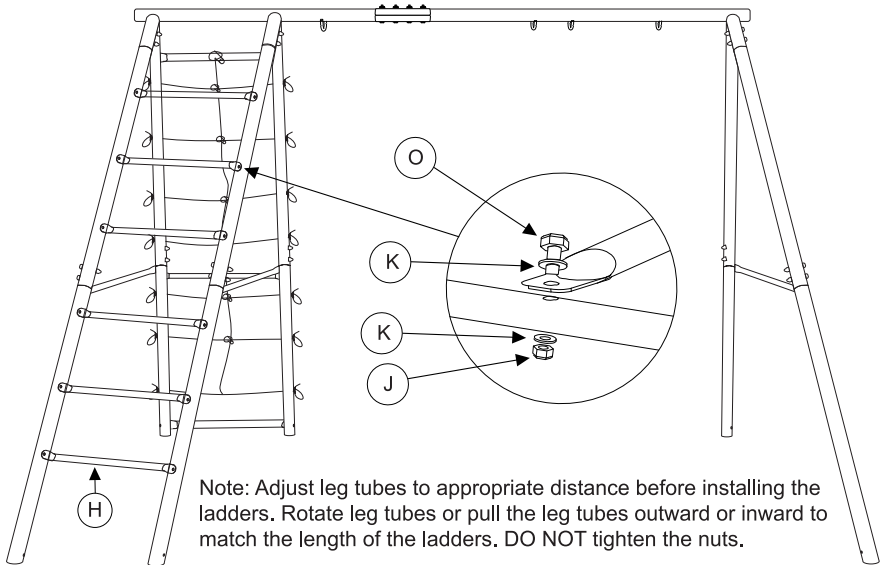



Step11: Install the rest 6 H tubes and tighten the screws with a spanner.

(Screw the nuts on loosely for 2-3 rounds. DO NOT tighten the nuts in case you need to adjust later.)



Note: Adjust leg tubes to appropriate distance before installing the ladders. Rotate leg tubes or pull the leg tubes outward or inward to match the length of the ladders. DO NOT tighten the nuts.

Tighten all the screws after the leg tubes, net and ladders are installed properly.

Quantity	Part Picture	Part Name
2	I 	Tube for basketball hoop
1	L 	Net for basketball hoop
3	Q 	M6 bolt (for basketball hoop)
1	K 	Washer
6	N 	Anchor
6	S 	M8 eye bolt + washer + big washer + M8 nonslip nut
1		M6 Spanner for basketball hoop
1		Iron bar for anchor installation

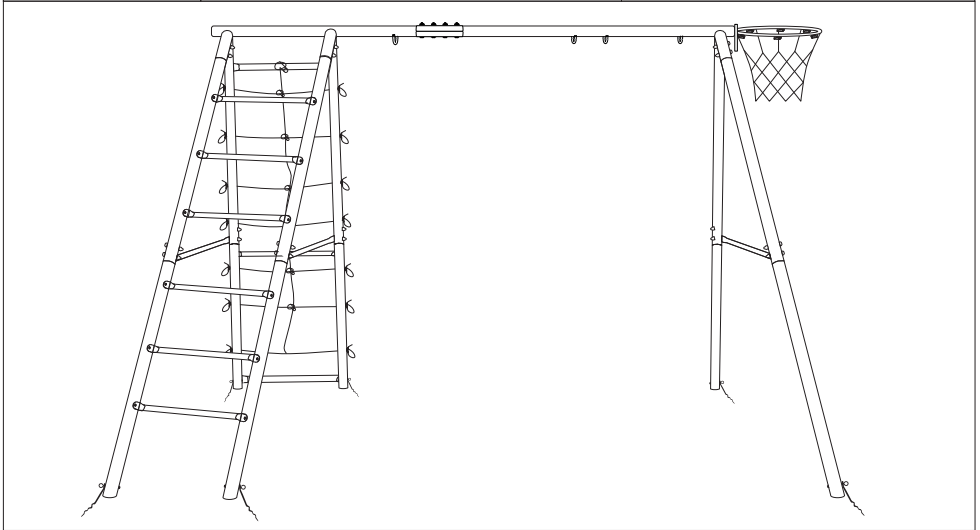

Step12: Joint the two I tubes into a circle, and tighten it with M6 screws.
(Note: Use M6 spanner to tighten.)

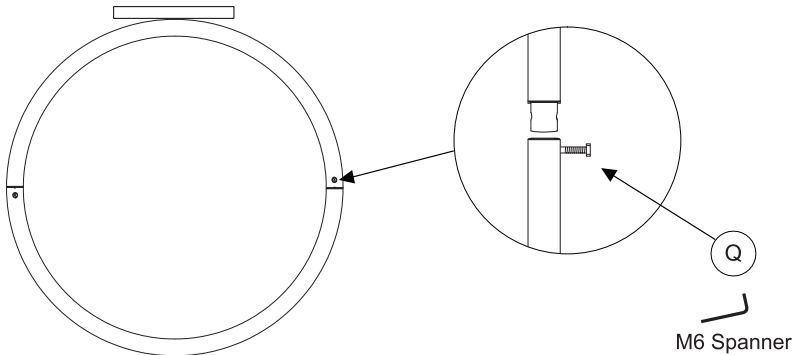

- Step13:** 1. Remove the washer and lock nut on the A2 tube as shown below;
2. Put the basketball hoop onto the bolt through the bottom two holes, then tighten the screws again.
3. Insert the Q screw into the top hole, tighten it by M6 spanner.
4. Attach the net on the basketball hoop.

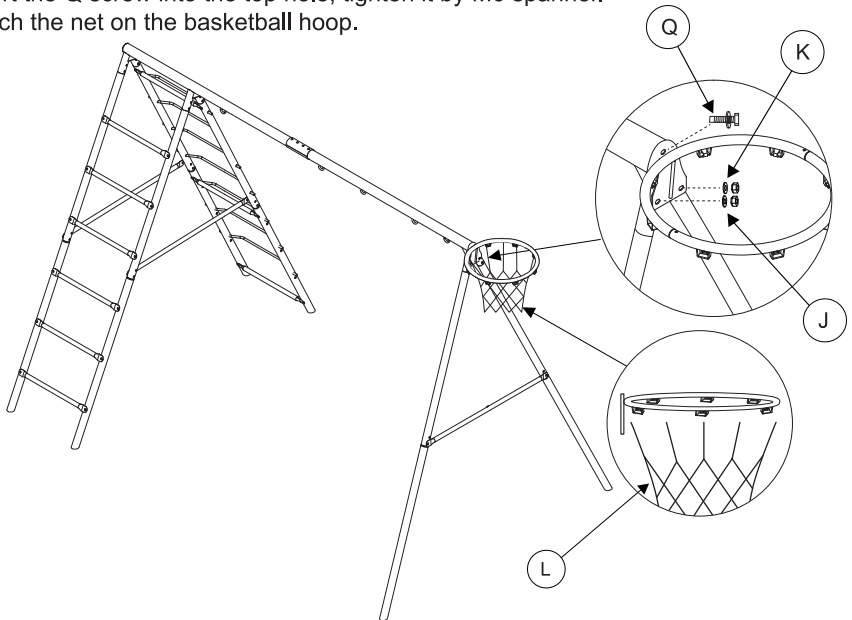

Step 14: Install all the anchors.

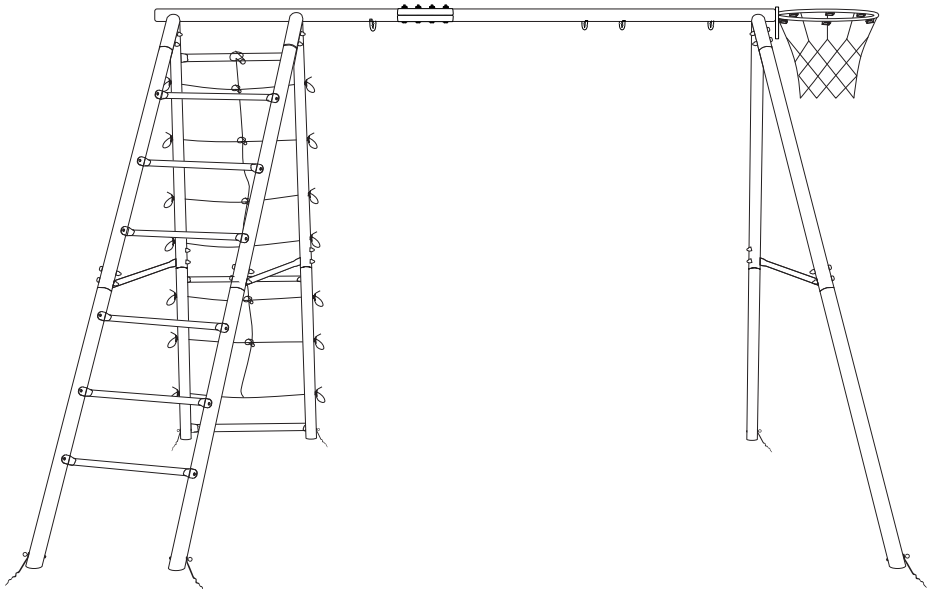

1. Use the iron bar to fix the ground stake to the position you intended.
2. Fix the swing frame with around stake.
3. Fasten the ground stake with S.

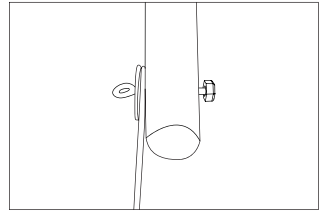
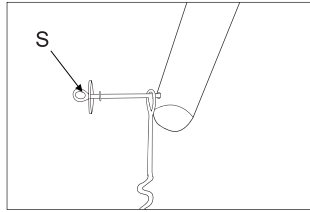
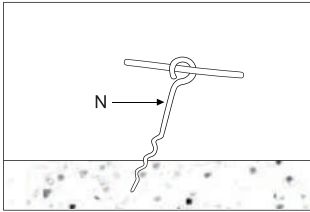

Quantity	Part Picture	Part Name
1		Swing seat
4		Carabiner
1		Swing seat
2		Suspension rope with bolt and nut
1		M8 Spanner for swing
4		Nut cap(for swing)

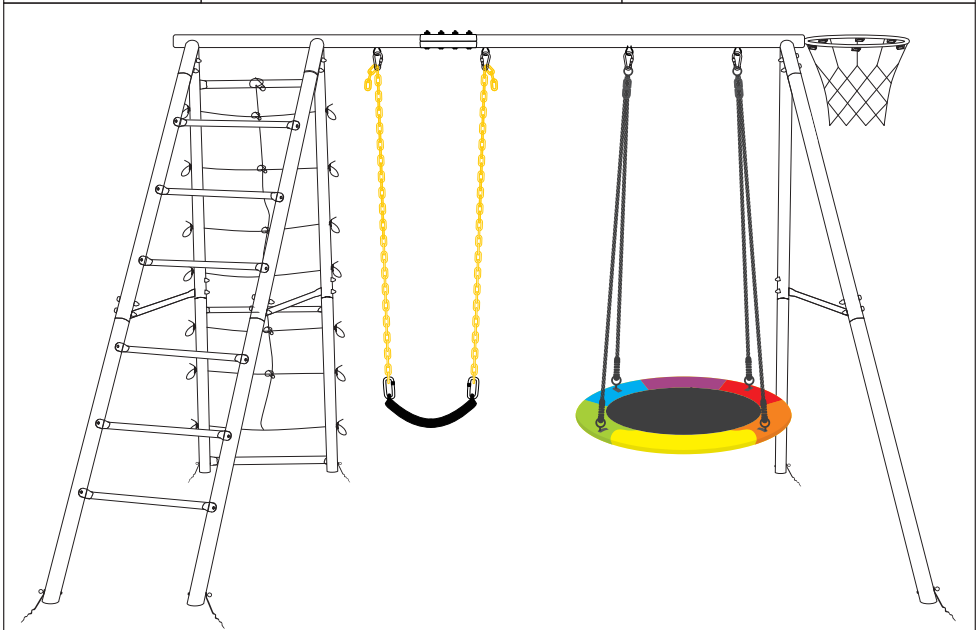

SWING ASSEMBLY INSTRUCTION

You can search the operation video "Trekassy swing instructions" on Youtube.

Tips: This is the general user manual of swing, the actual color refers to the item you purchased.

Figure 1: Insert 4 tubes into EVA foam tubes.

Figure 2: Insert 4 tubes with EVA foam padded into swing seat. (Attention: A bigger tube end is matched with a smaller one. If they are in the same size, it is unable to connect them.)

Figure 3: Joint random two adjacent tubes.

Joint other two adjacent tubes then you will get two semi-circle tubes.

Figure 4: Connect left two joint and you will get a round swing seat.



Figure 5: Cover it up with Hook&Loop then insert the bolt into the hole at the joint.

Figure 6: Put the washer and nut onto the bolt, and tighten with a wrench until 3-4 threads of bolts are exposed, then put the nut cap onto the bolt and tighten it. Please make sure all the screws are tightened for your safety. (You need an open-end wrench to fasten nut and nut cap.)

Figure 7: Assembly complete.

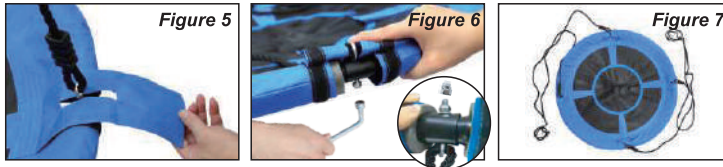

INSTALLATION

1. Adjust the length and keep balance.

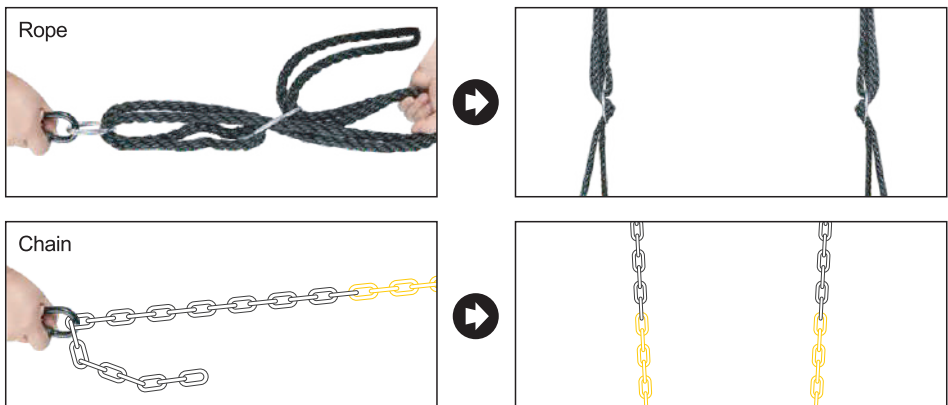

2. Make sure the screw lock of carabiner is 100% tightened.

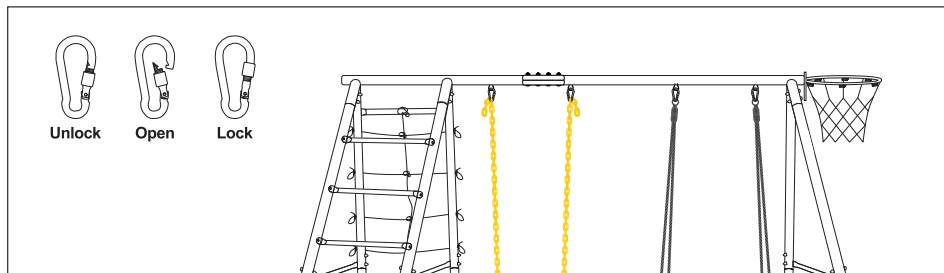

3. Installation complete.

